



**Motion Control Engineering, Inc.
11380 White Rock Road
Rancho Cordova, CA 95742**

voice 916 463 9200
fax 916 463 9201
www.mceinc.com

User Guide, iControl for AC Elevators

August 2008 Release

Copyright

© 2005, Motion Control Engineering. All Rights Reserved.

This document may not be reproduced, electronically or mechanically, in whole or in part, without written permission from Motion Control Engineering.

Trademarks

All trademarks or registered product names appearing in this document are the exclusive property of the respective owners.

Warning and Disclaimer

Although every effort has been made to make this document as complete and accurate as possible, Motion Control Engineering and the document authors, publishers, distributors, and representatives have neither liability nor responsibility for any loss or damage arising from information contained in this document or from informational errors or omissions. Information contained in this document shall not be deemed to constitute a commitment to provide service, equipment, or software by Motion Control Engineering or the document authors, publishers, distributors, or representatives.

Limited Warranty

Motion Control Engineering (manufacturer) warrants its products for a period of 15 months from the date of shipment from its factory to be free from defects in workmanship and materials. Any defect appearing more than 15 months from the date of shipment from the factory shall be deemed to be due to ordinary wear and tear. Manufacturer, however, assumes no risk or liability for results of the use of the products purchased from it, including, but without limiting the generality of the forgoing: (1) The use in combination with any electrical or electronic components, circuits, systems, assemblies or any other material or equipment (2) Unsuitability of this product for use in any circuit, assembly or environment. Purchasers' rights under this warranty shall consist solely of requiring the manufacturer to repair, or in manufacturer's sole discretion, replace free of charge, F.O.B. factory, any defective items received at said factory within the said 15 months and determined by manufacturer to be defective. The giving of or failure to give any advice or recommendation by manufacturer shall not constitute any warranty by or impose any liability upon the manufacturer. This warranty constitutes the sole and exclusive remedy of the purchaser and the exclusive liability of the manufacturer, AND IN LIEU OF ANY AND ALL OTHER WARRANTIES, EXPRESSED, IMPLIED, OR STATUTORY AS TO MERCHANTABILITY, FITNESS, FOR PURPOSE SOLD, DESCRIPTION, QUALITY PRODUCTIVENESS OR ANY OTHER MATTER. In no event will the manufacturer be liable for special or consequential damages or for delay in performance of this warranty.

Products that are not manufactured by MCE (such as drives, CRTs, modems, printers, etc.) are not covered under the above warranty terms. MCE, however, extends the same warranty terms that the original manufacturer of such equipment provide with their product (refer to the warranty terms for such products in their respective manual).

End User License Agreement

This End User License Agreement (“Agreement”) grants you the right to use the software contained in this product (the “Software”) subject to the following restrictions: You may not: (i) copy the Software, except for archive purposes consistent with your standard archive procedures; (ii) transfer the Software to a third party apart from the entire product; (iii) modify, decompile, disassemble, reverse engineer or otherwise attempt to derive the source code of the Software; (iv) export the Software or underlying technology in contravention of applicable U.S. and foreign export laws and regulations; and (v) use the Software other than in connection with operation of the product.

“LICENSOR'S SUPPLIERS DO NOT MAKE OR PASS ON TO END USER OR ANY OTHER THIRD PARTY, ANY EXPRESS, IMPLIED OR STATUTORY WARRANTY OR REPRESENTATION ON BEHALF OF SUCH SUPPLIERS, INCLUDING BUT NOT LIMITED TO THE IMPLIED WARRANTIES OF NON-INFRINGEMENT, TITLE, MERCHANTABILITY OR FITNESS FOR A PARTICULAR PURPOSE.”

Important Precautions and Useful Information

This preface contains information that will help you understand and safely maintain MCE equipment. We strongly recommend you review this preface and read this manual before installing, adjusting, or maintaining Motion Control Engineering equipment. This preface discusses:

- Safety and Other Symbol Meanings
- Safety Precautions
- [Environmental Considerations](#)

Safety and Other Symbol Meanings



Danger

This manual symbol is used to alert you to procedures, instructions, or situations which, if not done properly, might result in personal injury or substantial equipment damage.



Caution

This manual symbol is used to alert you to procedures, instructions, or situations which, if not done properly, might result in equipment damage.



Note

This manual symbol is used to alert you to instructions or other immediately helpful information.

Safety Precautions



Danger

This equipment is designed to comply with ASME A17.1, National Electrical Code, CE, and CAN/CSA-B44.1/ASME-A17.5 and must be installed by a qualified contractor. It is the responsibility of the contractor to make sure that the final installation complies with all local codes and is installed in a safe manner.

This equipment is suitable for use on a circuit capable of delivering not more than 10,000 rms symmetrical amperes, 600 volts maximum. The three-phase AC power supply to the Drive Isolation Transformer used with this equipment must originate from a fused disconnect switch or circuit breaker sized in conformance to all applicable national, state, and local electrical codes in order to provide the necessary motor branch circuit protection for the Drive Unit and motor. Incorrect motor branch circuit protection will void the warranty and may create a hazardous condition.

Proper grounding is vitally important to safe and successful operation. Bring your ground wire to the system subplate. You must choose the proper conductor size and minimize the resistance to ground by using the shortest possible routing. See National Electrical Code Article 250-95 or the applicable local electrical code.

Before applying power to the controller, physically check all the power resistors and other compo-

nents located in the resistor cabinet and inside the controller. Components loosened during shipment may cause damage.

For proper operation of the AC Drive Unit in your controller, you must make sure that: 1) A direct solid ground is provided in the machine room to properly ground the controller and motor. Indirect grounds such as the building structure or a water pipe may not provide proper grounding and could act as an antenna to radiate RFI noise, thus disturbing sensitive equipment in the building. Improper grounding may also render any RFI filter ineffective. 2) The incoming power to the controller and the outgoing power wires to the motor are in their respective, separate, grounded conduits.

This equipment may contain voltages as high as 1000 volts. Use extreme caution. Do not touch any components, resistors, circuit boards, power devices, or electrical connections without ensuring that high voltage is not present.

Environmental Considerations

- Keep the machine room clean.
- Controllers are generally in NEMA 1 enclosures.
- Do not install the controller in a dusty area.
- Do not install the controller in a carpeted area.
- Keep room temperature between 32 and 104 degrees F (0 to 40 degrees C).
- Prevent condensation on the equipment.
- Do not install the controller in a hazardous location or where excessive amounts of vapors or chemical fumes may be present.
- Make certain that power line fluctuations are within plus or minus 10% of proper value.

Air Conditioned Equipment Cabinets

If your control or group enclosure is equipped with an air conditioning unit, it is very important to observe the following precautions. (Failure to do so can result in moisture damage to electrical components.)

- Maintain the integrity of the cabinet by using sealed knockouts and sealing any holes made during installation.
- Do not run the air conditioning while the cabinet doors are open.
- If you turn the air conditioner off while it is running, wait at least five minutes before restarting it. Otherwise, the compressor may be damaged.
- Observe the recommended thermostat setting (75 degrees) and follow recommended maintenance schedules.
- Make certain that the air conditioning drain tube remains clear to avoid water accumulation in the unit.





Contents

Section Intro. Introduction

iControl - August 2008 Release	Intro-1
In This User Guide:	Intro-2
What's New	Intro-3
Using iView On-line Help	Intro-6
Using the Installation Checklist	Intro-7
Installation Checklist (page 1 of 3)	Intro-7
Installation Checklist (page 2 of 3)	Intro-8
Installation Checklist (page 3 of 3)	Intro-8

Section 1. iControl Description

About iControl	1-1
iControl Features	1-3
iControl Function	1-4
iControl	1-5
Easy Installation	1-6
iBox	1-7
LCD Display and Keypad	1-8
iBox Inputs and Outputs	1-9
AC Flux Vector Drives	1-10
iView Programming and Diagnostic Software	1-11
Controller Screen	1-11
Parameter Entry Screens	1-13
Active Displays	1-14
System Interconnect	1-15
iLand Landing System	1-17
iLink Car Top Communication	1-18
iCue Intelligent Dispatching	1-19
Local/Dispatcher	1-20
iMonitor Central Monitoring	1-21

iReport Logging and Report Generating	1-22
System Description	1-22
Optional Load Weighing System	1-23

Section 2. Construction Mode

In This Section	2-1
Before You Begin	2-2
Overview of Construction Mode.....	2-2
Machine Room Preparation	2-4
Equipment Location	2-4
Environmental Considerations	2-4
Ethernet and Internet Considerations	2-5
Recommended Tools and Test Equipment	2-6
About MCE Job Prints	2-7
Symbols	2-8
Nomenclature	2-8
Controller Cabinet Installation	2-9
Overview of Typical Connection Locations	2-11
Peripheral Inputs and Outputs.....	2-12
Equipment Grounding	2-14
Check for Shorts to Ground	2-16
AC Voltage Verification and Wiring	2-17
Verifying Main Line Power and Wiring the Controller	2-18
Initial Controller Power Up	2-19
AC Hoist Motor, Brake, and Velocity Encoder	2-21
Checking the Hoist Motor	2-21
Wiring the Hoist Motor to the Controller	2-21
Verifying Brake Current Resistance	2-22
Wiring the Brake	2-23
Velocity Encoder Installation and Wiring	2-24
Encoder Mounting.....	2-24
Encoder Isolation.....	2-25
Encoder Wiring	2-25
Basic Safety String and Associated Wiring	2-27
Cartop Safety Switches	2-27
Hoistway Safety Switches	2-28
Temporary CTS Relay Bypass	2-28
Access Locks and Contacts	2-28
Rope Gripper Wiring	2-29
Temporary Rope Gripper Bypass.....	2-29
Temporary Cartop Inspection Wiring	2-29
Applying Power	2-29

Setting Initial Operating Parameters	2-30
Connecting the iView PC	2-30
Direct Connections	2-35
Verifying Initial Parameter Settings	2-43
Learning the Safety Configuration	2-46
AC Drive Parameters	2-47
Drive Keypad	2-47
Drive Offsets Calibration	2-48
Automated Drive Setup Procedure	2-48
Manual Drive Setup Procedure	2-49
Brake Calibration	2-50
Rollback Compensation	2-50
Calibration	2-51
Verify Brake Picking	2-53
Running on Machine Room Inspection	2-54
Auto-tuning for Induction Motors	2-54
Verifying Car Direction and Motor Control (TORQMAX)	2-55
Verify Pattern Command and Drive Speed Feedback	2-56
Calibrating Actual Car Speed	2-57
Following Error Margin	2-58
Tach Error Tripping Threshold Adjustment	2-59
Electronic Motor Overload Protection Verification	2-60
Additional Adjustments and Checks	2-61

Section 3. Inspection Mode

In This Section	3-1
iLand Landing System	3-2
Position Feedback	3-2
Direction	3-2
Position	3-2
Landing Accuracy	3-2
Logic	3-2
Cartop Mounting	3-3
Positioning	3-3
Pedestal Fabrication and Mounting	3-4
Installation Instructions	3-5
Installing the Floor Leveling Magnets	3-9
Floor Leveling Magnet Installation Instructions	3-10
Cabling Connections	3-11
iLand Status LEDs	3-12
iView Parameter Setting	3-12

Installing iLink	3-13
Installing the iLink Enclosure	3-14
iLink Wiring	3-15
Front and Rear Door and Leveling Signals	3-16
Leveling Signals	3-16
Cartop Inspection Switches	3-17
Cartop Safety	3-17
Landing System Pulse Streams to iControl	3-17
iLink to iControl Serial Connection	3-17
iLink Power Connections	3-18
Car Operating Panel Connections	3-18
iLink Cartop Wiring Verification	3-19
Installing the Hoistway Limit Switches	3-19
Installing the Load Weigher	3-19
Installing Brake Monitoring	3-20
Installing the Earthquake Sensor	3-21
Temporary Bypass	3-21
Earthquake Reset	3-21
Installing the Serial Hall Call System	3-22
Installing the Serial COP System	3-22
Verifying Cartop Voltages	3-23
Verifying Door Operation	3-24
Verifying the Safety Configuration	3-25
Exit Construction Mode	3-25
Running on Machine Room Inspection	3-26
Verifying Quadrature Pulse Sequence and Encoder Resolution	3-27
Position Encoder Resolution	3-27
Quadrature Pulse Sequence	3-27
Prepare for Final Adjustments	3-28
Door Operator	3-28
Counterweight Learn Procedure	3-28
Counterweight Balancing	3-29
Run Testing	3-30
Empty Car Tests	3-31

Section 4. Final Adjustment

In This Section	4-1
Learning the Floor Heights	4-2
Floor Height Learn Procedure	4-2
Verifying One Floor Run Operation	4-3
Verifying Correction, Run, and Stop	4-3
If the Car Does Not Stop and Correct Properly	4-4

Initiating a One Floor Run	4-4
If Initiation is not Successful	4-4
Verifying a One Floor Run	4-5
Verify Releveling	4-6
Reaching Contract Speed	4-7
Final Adjustment Before Running at Contract Speed	4-7
Speed Pick Delay	4-7
Pattern Scaling	4-8
Learning Normal & Emergency Terminal Limit Switches	4-9
Fine Tuning the TORQMAX Drive	4-11
Up/Down High Speed Difference	4-11
Car Does Not Reach High Speed	4-11
Shaping the Speed Profile	4-12
Profile Parameters	4-12
Profiles	4-13
Setting Pattern Parameters	4-14
Controlling Initial Start of Car Motion	4-16
Pre-torque Adjustments	4-16
Load Weigher Sensor Adjustment	4-16
Pretorque Gain Adjustments	4-17
Drive Control Adjustments	4-19
Brake Parameter Adjustments	4-20
Calibrating the Floor Offsets	4-23
Floor offset calibration procedure	4-23
Adjusting Leveling and Final Stop	4-26
Final Approach and Leveling	4-26
Final Stop	4-26
Releveling Operation	4-29
Ride Quality	4-30
Load Weigher Adjustment for Dispatching	4-30
Load Weigher Configuration	4-32
Load Weigher Selection and Threshold Settings	4-32
Learning Load Values	4-33
Load Weigher Learn Procedure	4-34
Pre-Start Sequence	4-35
Allow machine to be energized: After doors are locked.	4-36
Allow the machine to be energized:	
When the door position monitor is activated	4-37
Allow the machine to be energized:	
While doors are closing with motor only.	4-38
Allow the machine to be energized:	
While doors are closing with motor and partially picked brake	4-39
Allow the machine to be energized:	
While doors are closing with motor and fully picked brake	4-40

Calibration and Verification of Safety Functions	4-41
Tach Error Tripping Threshold Adjustment	4-41
Verify Tach Error Does Not Trip on Emergency Stop	4-42
Safety Tests	4-43
Running a Test	4-44
Car/Counterweight Safety Test	4-45
Electrical Governor Test	4-46
Car/Counterweight Buffer Test	4-46
Inspection Overspeed Test	4-47
Contract Overspeed Test	4-47
Leveling Overspeed Test	4-48
Emergency Brake Test - Unintended Motion - Rope Brake	4-48
Emergency Brake Test - Unintended Motion - Machine Brake	4-49
Ascending Car Overspeed Test - Rope Brake	4-51
Ascending Car Overspeed Test - Machine Brake	4-52
Normal Terminal Switch Overspeed Tests	4-53
Emergency Terminal Switch Overspeed Tests	4-54
Normal and Emergency Terminal Switch Position Tests	4-54
Terminal Switch Overspeed and Position Faults	4-55
Before Release to Passenger Operation	4-57

Section 5. System Options

About System Options	5-1
iCentral - Central Dispatcher	5-2
Switching Between iCue & iView PCs	5-2
iCue Dispatching Capabilities	5-3
System Interconnect	5-4
Cabinet Installation	5-6
Check for Shorts to Ground	5-7
AC Voltage Verification and Wiring	5-7
Initial Power Up and Bus Verification	5-9
iControl Ethernet Overview	5-10
System TCP/IP	5-11
LAN TCP/IP	5-11
System Hub	5-12
LAN Hub	5-13
External Connections	5-14
Ethernet Addresses	5-14
TCP/IP Reference	5-15
System Ethernet	5-18
LAN Ethernet	5-18
Setting iView PC LAN IP Addresses	5-18
Setting iCue PC LAN IP Addresses	5-21
Pinging	5-24
iCue User Interface	5-25
Write Permission	5-26
iCue Watchdog	5-27

Comm-connect Cabinet - Local/Dispatcher	5-28
Serial Hall Call	5-30
Hall Call Installation	5-32
Pulling Serial Bus Wiring	5-32
Setting Node Board Addresses	5-33
Checking Serial to IP Connections	5-35
Troubleshooting	5-36
Serial/Ethernet Translation	5-36
SC-HCE Assemblies	5-36
Trouble Indications	5-39
Hall Call Driver	5-43
Flexible I/O	5-45
SC-ION Boards	5-46
I/O Connections	5-47
Board Programming	5-47
Serial COP	5-48
Serial COP Board Specifications	5-50
Serial COP Installation	5-51
EMCO Load Weigher Installation and Calibration	5-53
Installing the Sensors	5-54
Installing the Control Unit and Connecting the Wires	5-55
PROGRAMMING the EMCO VK-3v Control Unit	5-56
Description of Operation	5-56
How to Program the EMCO Load Weigher Control Unit	5-56
Menu/Programming Order	5-56
Calibration	5-57
Manual Calibration with Weights	5-57
Auto-zero Calibration	5-58
Final Calibration with iControl	5-59
Additional iControl Settings and Procedures	5-60
Installation with 2 to 1 Roping	5-61
Verifying the zero calibration (empty car weight)	5-62
Troubleshooting	5-62
MCE Load Weigher	5-63
Installation Method #1 — Preferred	5-64
Method #1 Installation Instructions	5-67
Installation Method # 2	5-69
Installation Method # 3	5-69

Section 6. Troubleshooting

About Troubleshooting	6-1
Troubleshooting Tools	6-2
Safety String Bypass Jumper	6-3
Message Tables	6-4
iControl Messages	6-13

Circuit Boards and Assemblies	6-79
Circuit Board Removal and Replacement	6-79
iBox Removal and Replacement	6-80
iBox Configuration File	6-80
iBox Removal	6-80
iBox Installation	6-81
iBox File Upload	6-81
iControl Circuit Board Quick References	6-82
ICE-COP Serial Car Operating Panel Board QR	6-83
ICE-COP Board Diagnostics	6-84
ICE-CTP Cartop Processor Board Quick Reference	6-86
ICE-CTP Cartop Diagnostics	6-89
ICE-EB Emergency Brake Board Quick Reference	6-92
ICE-FML Field Module Logic Board Quick Reference	6-93
ICE-IEQ Earthquake Board Quick Reference	6-96
ICE-IMP Main Processor Board Quick Reference	6-98
ICE-IRB Relay Board Quick Reference	6-100
Checking TM Triac on ICE-IRB Board	6-102
ICE-IRD Rear Door Board Quick Reference	6-103
ICE-LCB Low Current Brake Board Quick Reference	6-104
ICE-MIAC Multiple Input AC Board Quick Reference	6-104
ICE-MOR Multiple Output Relay Board Quick Reference	6-107
Output Connections	6-107
ICE-RG Rope Gripper Board Quick Reference	6-109
ICE-SAF Safety Board Quick Reference	6-111
ICE-SF-x Serial Fixtures Board Quick Reference	6-116
SC-HCDA-ISO Serial Hall Call Driver Isolation Board QR	6-117
SC-HCE-ME Serial Hall Call Ethernet - Digi ME Board QR	6-118
SC-HCN Serial Hall Call Node Board Quick Reference	6-119
SC-ION: Serial Control I/O Board Quick Reference	6-120
I/O Connections	6-120

Section 7. iBox Front Panel Controls

About the iBox Front Panel	7-1
LCD Display and Keypad	7-3
Keypad Controls	7-4
LCD Display	7-4
Parameter Entry	7-5
Editing a Controller Parameter	7-6
Setting iBox Ethernet Port Addresses	7-9
IP Address Verification/Setting	7-10
System Status Display	7-11
LED Status Display	7-11
LCD Status Display	7-12
System Control Switches	7-12
Safety Bypass Jumper and Fuses	7-13

Section 8. Using iView

About iView	8-1
How iView Works	8-2
Installing iView	8-3
Getting Started	8-4
Direct Connections	8-5
LAN Connections	8-13
Creating a New LAN Connection	8-13
Working Online	8-17
Viewing and Adjusting Settings	8-18
Sending Adjustments to the Controller	8-19
Saving Parameters to a Configuration File	8-20
Save to File	8-20
Saving Default Parameters to a Configuration File	8-21
Loading Parameters from a Configuration File	8-22
Working Offline	8-23
Accessing Online Help	8-24
iView Windows and Tabs	8-25
Controller - Configuration Tabs	8-25
Controller - Diagnostic Tabs	8-25
Controller - Setup Tabs	8-25
Additional Windows	8-25
Controller - Layouts	8-30
System View Windows and Tabs	8-31
System - Configuration Tabs	8-31
System - Diagnostic Tabs	8-31
Additional Windows	8-31
Pinning and Unpinning Windows	8-33
Resizing Windows	8-34
Docking and Undocking Windows	8-35
Printing Screens	8-38
Setting the System's Date and Time	8-38
Editing Dynamic Displays	8-39

Section 9. iView - Controller View

About this Section	9-1
Selecting Controller View	9-1
Controller View Windows and Tabs	9-2
iView Button Bar	9-3
iView Status Bar	9-3
Hoistway window	9-4
Mode of Operation	9-5

Operational Status tab	9-8
Speed	9-8
Processor health	9-8
In-service	9-8
Time Remaining for	9-8
Motion	9-9
Position	9-9
Machine	9-9
Door lock	9-10
Leveling sensor	9-10
Pattern	9-10
Faults	9-10
Car status	9-10
Diagnostics Tabs	9-11
Diagnostics - Data Trap	9-11
Diagnostics - Diagnostic Flags	9-12
Diagnostics - Diagnostic Outputs	9-13
Diagnostics - Event Log	9-14
Diagnostics - Fault Bypass	9-17
Diagnostics - Terminal Switches Status	9-19
Diagnostics - Virtual Oscilloscope	9-21
Display Editing	9-22
Configuration Tabs	9-24
Configuration - Brake Tab	9-24
Brake - Control Tab - Voltage	9-25
Brake - Control Tab - Filter	9-25
Brake - Control Tab - Switch	9-25
Brake - Control Tab - Timers	9-26
Brake - Configuration Tab	9-27
Configuration - Car Call Enable	9-28
Configuration - Car Operation	9-29
Car Operation - Doors tab	9-30
Car Operation - Devices Tab	9-33
Car Operation - Passenger Tab	9-37
Passenger - Door operation tab	9-40
Passenger - Door operation - Front / Rear tabs	9-42
Car Operation - Fire Service Tab	9-44
Fire Service - Fire Code	9-45
Fire Code - Recall - General Tab	9-47
Fire Code - Recall - Front / Rear Door Tabs	9-50
Fire Code - In-Car - General Tab	9-52
Fire Code - In-Car - Front / Rear Tabs	9-55
Fire Code - In-Car Recall - Front / Rear Tabs	9-57
Car Operation - Independent Service Tab	9-59
Car Operation - Elevator Recall Tab	9-61
Car Operation - Earthquake Tab	9-64
Car Operation - EMS Tab	9-66
Car Operation - Emergency Power Tab	9-70

Car Operation - CFSS Tab	9-73
Car Operation - Flood Operation Tab	9-76
Car Operation - Attendant Service Tab	9-78
Car Operation - Auto Stop Tab	9-79
Car Operation - Sabbath Tab	9-81
Car Operation - Shuttle Service	9-84
Car Operation - Heat Detectors	9-86
Configuration - Drive	9-87
Drive - General Tab	9-88
Drive - Safety Tab	9-90
Drive - Filters Tab	9-91
Drive - Pretorque Tab	9-92
Drive - Calibration Tab	9-93
Configuration - Floor Heights	9-94
Configuration - General	9-95
General Tab	9-95
General - Floor Data Tab	9-96
General - Car Call Eligibility Tab	9-97
Configuration - I/O Boards	9-100
I/O Board - Configurable outputs	9-105
Input Signal Groups	9-106
Output Signal Groups	9-115
Configuration - iBox Configuration	9-125
Configuration - Loadweigher	9-126
Configuration - Pattern	9-128
Pattern - Common Tab	9-129
Pattern - Modes Tab	9-131
Configuration - Terminal Switches	9-134
Configuration - Timer Tables (Controller)	9-135
Features	9-135
Timer Details	9-136
Timers	9-136
Configuration - Advanced - User Events	9-138
Configuration - Advanced - Custom Outputs	9-139
Controller - Setup Tabs	9-140
Setup - Brake Tab	9-140
Setup - Counterweight Tab	9-141
Setup - Drive Tab	9-142
Setup - Floor Heights - Learn Tab	9-143
Setup - Floor Heights - Floor Offsets Tab	9-145
Setup - Load Weigher Tab	9-146
Setup - Safety - Configuration Tab	9-147
Configuration	9-148
Learn	9-149
Setup - Safety - Inventory Tab	9-150

Setup - Terminal Switches Tab	9-151
Controller - Safety Tests	9-152
Controller - Layouts	9-153
Call Registration	9-154
Controller - Firmware Update	9-155
Upgrade Options	9-157

Section 10. iView - System View

About this Section	10-1
Selecting System View	10-1
System View Windows and Tabs	10-2
Button Bar	10-2
iView Status Bar	10-3
An Overview of System Options	10-4
System Configuration tab	10-6
Building	10-7
CFSS (Commandeer for Special Services)	10-9
Dispatching - Options	10-11
Dispatching - Configurations	10-12
Hall Call Eligibility	10-13
Mode of Operation	10-14
Select a Configuration	10-14
Mode of Operation	10-14
Automatic	10-15
Balanced	10-17
Lobby Peak	10-18
Demand Up Peak	10-19
Demand Down Peak	10-19
Parking	10-20
Parking Configurations	10-21
Set Parking Delay Timers	10-21
Choose Dynamic or User-Defined Parking	10-22
Sector Dispatching	10-25
Sending Changes to iControl	10-26
Parking Eligibility	10-27
Split Bank Operation	10-29
Management	10-31
Remote Monitoring Authorization	10-31
Local Dispatcher	10-32
Configuration Tabs - Emergency Power	10-33
Defining Emergency Power Behavior	10-34
Configuration Tabs - Legacy Group Interface	10-36
Cross-registration	10-36
Cross-cancellation	10-37

Configuration Tabs - Security	10-38
General - Status	10-38
General - Configuration	10-39
General - Manage Passwords	10-40
Security - General	10-41
Hall Calls	10-42
Per-Floor Security	10-42
Per-Car Lockout	10-44
Car Calls - Configuration	10-45
Car Calls - Mode Overrides	10-47
Car Calls - Passcodes	10-48
Car Calls - Passcodes - Floor	10-48
Car Calls - Passcodes - Passenger	10-49
Configuration Tabs - System I/O	10-51
System Tab	10-51
Default Calls Button	10-52
Configure Button	10-52
Configuring System I/O	10-53
System I/O - Bus Tab	10-60
Configuration Tabs - Timer Tables (System)	10-62
Features	10-62
Timer Details	10-63
Timers	10-63
Configuration Tabs - User Events	10-65
.....	10-65
Configuration Tabs - Remote Outputs	10-66
Diagnostic Tabs - Event Log	10-68
System - Hoistway	10-70
Per Car Display	10-72
Call Registration	10-73
System Performance	10-74
System - Layouts	10-75

Section 11. Reference

About this Section	11-1
iControl AC Specifications	11-2
Software Test Point Signals	11-3
iBox Field Connections	11-7
System and LAN Ethernet	11-15
MCE Direct-Connect Port (Links one iBox to one Laptop with iView)	11-15
Elevator LAN Network	11-16
Summary	11-19
Summary by Group	11-20

TORQMAX F5 Drive Parameters Quick Reference	11-27
PowerBack R6 Regenerative Drive Quick Reference	11-31



Introduction

iControl - August 2008 Release

Welcome! This user guide is intended for use with the August 2008 release of iControl. It includes additional features and capabilities which are outlined in this section and described in detail elsewhere in this guide. If you are viewing this document on a PC, click the hyperlinks to jump to the topics shown in blue.

What's in this Introduction?

- In this User Guide (Intro [page 2](#))
- What's New (Intro [page 3](#))
- Using iView On-line Help (Intro [page 6](#))
- Using the Installation Checklist (Intro [page 7](#))

If you are an experienced iControl user:

- See "In This User Guide:" on Intro [page 2](#). The material in this guide is arranged in a slightly different order from previous editions.
- See "What's New" on Intro [page 3](#). There you will learn about the new features and capabilities that have been added in this release.
- See "Using the Installation Checklist" on Intro [page 7](#). For future installations you may only need to refer to this checklist or, at most, look up the detailed instructions for a few items on the checklist.

In This User Guide:

This is the installation, adjustment, and troubleshooting guide for iControl AC traction elevators. When viewed online as a PDF file, hyperlinks link to related topics and informational websites. The user guide includes:

- **Contents: Table of Contents.** When viewed online as a pdf file, hyperlinks in the Contents link to the associated topic in the body of the manual.
- **Introduction: Introduction.** Provides an overview of what's in this user guide and what's new in this release.
- **Section 1: iControl Description.** Provides an overview and introductory information about iControl, the iBox, the iView graphical user interface, and other system options.
- **Section 2: Construction Mode.** Complete instructions on installing iControl and bringing the elevator up on Construction Mode.
- **Section 3: Inspection Mode.** Complete instructions on continuing the elevator installation and adjustment up to Inspection Mode.
- **Section 4: Final Adjustment.** Step-by-step instructions on making the final adjustments necessary to release the elevator to normal *passenger* operation.
- **Section 5: System Options.** Installation instructions for various system options including Central Dispatching, Local/Dispatching, Serial Hall Call, Serial COP, EMCO Load Weigher and MCE Load Weigher.
- **Section 6: Troubleshooting.** Information about diagnosing and correcting improper system operation.
- **Section 7: iBox Front Panel Controls.** Detailed information about the parameter displays/adjustments and function switches on the front panel of the iBox.
- **Section 8: Using iView.** Detailed information about the iView graphical user interface. iView software runs on any PC running Windows 2000 or Windows XP and is the primary tool used to view and adjust iControl parameters, diagnose problems, and monitor system health.
- **Section 9: iView - Controller View.** Detailed information about the adjustable "Controller" parameters, screen-by-screen and parameter-by-parameter.
- **Section 10: iView - System View.** Detailed information about the adjustable "System" parameters, screen-by-screen and parameter-by-parameter.
- **Section 11: Reference.** Additional technical information provided for elevator mechanics and adjusters.
- **Index: Index.** Alphabetical index to help you find information in the manual. When viewed online as a PDF file, index entry page references are hyperlinks to the associated information in the body of the manual.

What's New

Many new features and capabilities have been added to iControl in the most recent releases. The following is a list of many of the new features:

Alternate Dispatcher - Local/Dispatcher Previously iControl included the capability for one of a group's car controllers to assume dispatching responsibilities (Backup Dispatcher) when the Central Dispatcher is not available. With this release, any or all of the *Local* car controllers can be designated as an *Alternate Dispatcher* and can assume dispatching responsibilities for the group. In many instances a Central Dispatcher is not required. For more information see ["An Overview of System Options" on page 10-4](#) and see ["Alternate Dispatcher" on page 10-8](#).

Status Bar - Controller Type The status bar, at the bottom-left of the iView window, indicates the type of controller to which iView is connected (see ["iView Status Bar" on page 9-3](#)).

Split Bank Dispatching Split Bank operation allows some of the cars in a group to be dispatched as a separate group and to respond to hall calls from an alternate riser. For more information see ["Split Bank Operation" on page 10-29](#).

Third Party Authorization In order to control access to iControl data, this tool is used to authorize a third party monitoring tool to connect to the iControl system (see ["Management" on page 10-31](#)).

System I/O Status Indicators LEDs indicate the current status, On or Off, of the input and/or output at each node address (see ["System I/O - Bus Tab" on page 10-60](#)).

Per-car Hall Call Security Hall call lock out can now be applied per-car, per-floor and per-direction (see ["Per-Car Lockout" on page 10-44](#)).

Per-Passenger Car Call Security Unique car call enable passcodes may be assigned to individual passengers. Activity associated with the use of these passcodes may be viewed using iReport (see ["Car Calls - Passcodes - Passenger" on page 10-49](#)).

System - User Events Users can assign a name to an *Input / User Event*. Up to 10 Input / Event Names can be programmed. This event name can then be assigned to a hardware input. An event is logged, on the System Event Log, when the input is activated and again when it is deactivated (see ["Configuration Tabs - User Events" on page 10-65](#)).

System - Remote Outputs Users can configure system outputs which can be wired to an input or other device. The outputs can be turned on and off remotely via iView or iMonitor or via a timer (see ["Configuration Tabs - Remote Outputs" on page 10-66](#)).

System Event Log An Event Log has been created to record the System events (see ["Diagnostic Tabs - Event Log" on page 10-68](#)).

Enhanced Controller Event Log An event filter has been added to the controller Event Log to allow the user to select which events are logged (see ["Diagnostics - Diagnostic Outputs" on page 9-13](#)). Troubleshooting Tips for each event can be displayed with the click of a button.

Clear Event Log The data stored in the event logs, controller and system, can be easily cleared using the Clear all button on the event log's button bar.

Data Trap This diagnostic tool automatically records controller data including input and output states, internal flags and parameter values (see [“Controller - Safety Tests” on page 9-152](#)).

Hoistway Access Recall To facilitate ease of gaining hoistway access, controls have been added to allow the activation of a hoistway access switch/input to also recall the car (see [“Hoistway Access Recall” on page 9-63](#)).

Shuttle Service The Shuttle Service option allows a local car to provide express service for a subset of the building's floors. For more information see [“Car Operation - Shuttle Service” on page 9-84](#).

I/O Assertion This troubleshooting tool allows the user to bypass the current state of a terminal on an I/O board and assert a desired state (on or off) via iView (see [“I/O Assert” on page 9-102](#)).

System I/O for Simplex and Swing Cars The inputs and outputs normally supplied to the dispatcher via the Serial Hall Call system are now available on the MIAC and MOR boards.

Controller - User Events Users can assign a name to an *Input / User Event*. Up to 10 Input / Event Names can be programmed. This event name can then be assigned to a hardware input. An event is logged, on the Controller Event Log, when the input is activated and again when it is deactivated (see [“Configuration - Advanced - User Events” on page 9-138](#)).

Controller - Custom Outputs Custom Outputs is an advanced feature that allows existing controller inputs, outputs and internal flags to be used in custom logic equations which can then generate controller outputs (see [“Configuration - Advanced - Custom Outputs” on page 9-139](#)).

Rope Tension Load Weigher An additional load weighing option, which measures tension of the wire ropes, is now available for use with iControl (see [“EMCO Load Weigher Installation and Calibration” on page 5-53](#)).

Default Configuration File The Controller and/or System default parameter settings can be saved to a configuration (.cfg) file. The default parameter values can then be loaded onto the controller (see [“Saving Parameters to a Configuration File” on page 8-20](#)).

Brake Contact Input Controls have been added to allow the polarity of the brake contact input to be set to either active high or low (see [“Brake - Control Tab - Switch” on page 9-25](#)).

TAPS Interface Controls and logic have been added to allow iControl with AC Drive to use the new Traction Auxiliary Power Supply (TAPS) (see [“Car Operation - Emergency Power Tab” on page 9-70](#)).

Serial Drive Control An option has been added to allow iControl to communicate speed commands and receive speed feedback from the AC drive via a serial link.

Car Statistics iControl accumulates statistical data which can be used in maintaining the elevator. The statistics include distance traveled (odometer), power up cycles, front and rear door cycles, motion cycles, floor time, floor runs, inspection runs, auto runs and auto relevels. This data can be viewed on the iBox onboard display (Car menu), which also allows the data to be cleared.

Write Privilege Time-Out Controls have been added to the iBox OBD Mgmt menu to set the write privilege time-out time and to cancel write privilege (see [“Mgmt Menu Parameters” on page 7-9](#)).

Clone Controller Data Allows the controller’s parameter settings to be saved to flash memory in order to facilitate easy field replacement of an iBox (see [“Mgmt Menu Parameters” on page 7-9](#)).

Upgrade Wizard A special utility has been created facilitate field upgrade of iBox firmware programs.

Using iView On-line Help

iView is a graphical user interface which runs on a Windows PC or laptop computer. The computer is typically connected to iControl through a Local Area Network. The iView program provides the main user interface to iControl. It allows the user to view and set Controller and System operating parameters.

On-line help is incorporated into iView to provide information about iControl screens and parameters. You can access iView On-line Help in the following ways:

Context Sensitive Help You can view On-line Help information about any screen or tab by pressing function-key one (F1) while a screen or tab has focus. Do the following:

- Click the title bar of a window, e.g., the Hoistway window, to bring focus to the window. The background color of the window's title bar darkens indicating that the window has focus. Then press the F1 key. iView Help will display the topic that describes the window.
- Click a tab (title). An outline will appear around the tab title indicating that the tab has focus. Then press the F1 key. iView Help will display the topic that describes the tab.

Context Sensitive Event Help iControl logs status and error information in the Controller - Event Log (see [“Diagnostics - Diagnostic Outputs” on page 9-13](#)). To view the Event Log, Event Properties and Context Sensitive Event Help:

1. In the Controller view, click View > Diagnostics > Event Log to display the Event Log.
2. Double click an event in the Event Log to display the Event Properties dialog.
3. Click the Help button in the Event Properties dialog to display the Troubleshooting Tips dialog which provides a description of the event, an indication of what action is taken, and troubleshooting tips if appropriate.

Help Viewer iView On-line Help provides three additional ways of locating information. The Contents and Index tabs let you find general information. The Search tab lets you look up specific words or phrases.

To start iView On-line Help:

1. On the iView menu bar, click Help.
2. On the Help menu, click iView Help. The help viewer is displayed. Use the Contents, Index or Search tabs to locate the desired information.

iView On-line Help provides the following kinds of information:

- Using iView Help - A description of the many options, capabilities and ways of using iView On-line Help.
- Using iView - Provides information and instructions on how to use the iView graphical user interface.
- iView Windows and Tabs - Lists all of the iView windows and tabs and provides links to descriptions of the parameters on each tab.
- Message Reference - An alphabetical listing of iControl status and error messages. Each listing includes a description, an indication of what action is taken, and troubleshooting tips.
- Parameter Reference - a tab by tab listing of all of the Controller and System parameters including a description of each parameter.

Using the Installation Checklist

This checklist provides general instructions to help experienced personnel install an iControl AC elevator controller. Should you need detailed information for any item on the checklist, refer to the specific sections of the User Guide suggested.

Installation Checklist (page 1 of 3)

- Review the “Safety Precautions” in the Preface of the *User Guide, iControl with AC Drive* and see [“Before You Begin” on page 2-2](#).
- Review the job prints. They are always the controlling document (see [“About MCE Job Prints” on page 2-7](#)).
- Review the machine room preparation guidelines (see [“Machine Room Preparation” on page 2-4](#)).
- Check the controller visually. Verify that nothing has been damaged or dislodged during shipment.
- Review the controller installation guidelines (see [“Controller Cabinet Installation” on page 2-9](#)).
- Open cable access holes in the areas indicated by the stickers. Ensure that no metal filings get into the electronics (see [“Cable Access” on page 2-10](#)).
- Review the typical connection locations (see [“Overview of Typical Connection Locations” on page 2-11](#) and see [“iBox Field Connections” on page 11-7](#)).
- Ground all equipment according to the job prints and local code (see [“Equipment Grounding” on page 2-14](#)).
- Install the field wiring as shown on the job prints.
- Check for shorts to ground (see [“Equipment Grounding” on page 2-14](#)).
- Verify the main line power wiring (see [“AC Voltage Verification and Wiring” on page 2-17](#)).
- Verify proper bus voltages (see [“Initial Controller Power Up” on page 2-19](#)).
- Install and verify the wiring to the hoist motor (see [“Checking the Hoist Motor” on page 2-21](#) and see [“Wiring the Hoist Motor to the Controller” on page 2-21](#)).
- Verify the brake current resistance and install the brake wiring (see [“Verifying Brake Current Resistance” on page 2-22](#) and see [“Wiring the Brake” on page 2-23](#)).
- Install the encoder / tachometer (see [“Velocity Encoder Installation and Wiring” on page 2-24](#)).
- Verify the safety string wiring (see [“Basic Safety String and Associated Wiring” on page 2-27](#)).
- Install the temporary cartop inspection controls (see [“Temporary Cartop Inspection Wiring” on page 2-29](#)).
- Apply power and verify that the iBox is functioning (see [“Applying Power” on page 2-29](#)).
- Connect / verify the iView PC connection (see [“Connecting the iView PC” on page 2-30](#)).
- Verify the initial parameter settings (see [“Verifying Initial Parameter Settings” on page 2-43](#)).
- Learn the safety configuration (see [“Learning the Safety Configuration” on page 2-46](#)).
- Perform the automated drive setup procedure (see [“Automated Drive Setup Procedure” on page 2-48](#)).

Installation Checklist (page 2 of 3)

- Calibrate the brake (see [“Brake Calibration”](#) on page 2-50).
- Verify that the brake is picking properly (see [“Verify Brake Picking”](#) on page 2-53).
- Verify proper car movement on inspection (see [“Verifying Car Direction and Motor Control \(TORQMAX\)”](#) on page 2-55).
- Verify pattern command and drive speed feedback (see [“Verify Pattern Command and Drive Speed Feedback”](#) on page 2-56).
- Calibrate the car speed (see [“Calibrating Actual Car Speed”](#) on page 2-57).
- Set the following error parameter - tach error tripping threshold (see [“Following Error Margin”](#) on page 2-58 and see [“Tach Error Tripping Threshold Adjustment”](#) on page 2-59).
- Verify electronic motor overload protection (see [“Electronic Motor Overload Protection Verification”](#) on page 2-60).
- Verify proper mounting of iLand landing system (see [“Cartop Mounting”](#) on page 3-3).
- Verify proper installation of the floor magnets (see [“Installing the Floor Leveling Magnets”](#) on page 3-9).
- Verify iLand connection to iLink (see [“Cabling Connections”](#) on page 3-11).
- Verify proper installation of iLink (see [“Installing iLink”](#) on page 3-13).
- Install the hoistway limit switches per the job prints (see [“Installing the Hoistway Limit Switches”](#) on page 3-19).
- Install the Load Weigher, if applicable (see [“Installing the Load Weigher”](#) on page 3-19 and see [“EMCO Load Weigher Installation and Calibration”](#) on page 5-53 or see [“MCE Load Weigher”](#) on page 5-63).
- Install the optional Brake Pick Switch, if applicable (see [“Installing Brake Monitoring”](#) on page 3-20).
- Install the earthquake sensor, if applicable (see [“Installing the Earthquake Sensor”](#) on page 3-21).
- Install the serial hall call system (see [“Installing the Serial Hall Call System”](#) on page 3-22).
- Install the serial COP system, if applicable (see [“Installing the Serial COP System”](#) on page 3-22).
- Verify the cartop voltages (see [“Verifying Cartop Voltages”](#) on page 3-23).
- Verify door operation (see [“Verifying Door Operation”](#) on page 3-24).
- Verify the safety configuration (see [“Verifying the Safety Configuration”](#) on page 3-25).
- Exit construction mode / begin running on inspection (see [“Exit Construction Mode”](#) on page 3-25 and see [“Running on Machine Room Inspection”](#) on page 3-26).
- Verify the quadrature pulse sequence (see [“Verifying Quadrature Pulse Sequence and Encoder Resolution”](#) on page 3-27).
- Perform final door operator checks (see [“Door Operator”](#) on page 3-28).
- Perform the counterweight learn and counterweight balancing procedures (see [“Counterweight Learn Procedure”](#) on page 3-28).
- Perform the run and empty car tests (see [“Run Testing”](#) on page 3-30 and see [“Empty Car Tests”](#) on page 3-31).

Installation Checklist (page 3 of 3)

- Learn the building floor heights (see [“Learning the Floor Heights”](#) on page 4-2).

-
- ❑ Verify proper one-floor run operation (see [“Verifying One Floor Run Operation”](#) on page 4-3).
 - ❑ Verify proper releveling (see [“Verify Releveling”](#) on page 4-6).
 - ❑ Verify proper speed pick delay and pattern scaling (see [“Final Adjustment Before Running at Contract Speed”](#) on page 4-7).
 - ❑ Learn the terminal slowdown and limit switches (see [“Learning Normal & Emergency Terminal Limit Switches”](#) on page 4-9)
 - ❑ Fine tune the TORQMAX drive (see [“Fine Tuning the TORQMAX Drive”](#) on page 4-11).
 - ❑ Verify the pattern parameter settings with regard to contract speed overshoot and current limiting, the slope of acceleration and deceleration, final approach to the floor, excessive motor noise and bunching up of deceleration rate (see [“Setting Pattern Parameters”](#) on page 4-14).
 - ❑ Verify the parameter settings that control the initial start of car motion, e.g. load weigher sensor and pretorque gain adjustments and motor control and brake parameter adjustments (see [“Controlling Initial Start of Car Motion”](#) on page 4-16).
 - ❑ Calibrate the floor offsets (see [“Calibrating the Floor Offsets”](#) on page 4-23).
 - ❑ Verify the parameter settings related to final approach, leveling, final stop and releveling (see [“Adjusting Leveling and Final Stop”](#) on page 4-26).
 - ❑ Verify the load weigher adjustments for dispatching and load weigher configuration, if applicable (see [“Load Weigher Adjustment for Dispatching”](#) on page 4-30 and see [“Load Weigher Configuration”](#) on page 4-32).
 - ❑ Verify the pre-start sequence parameters, if applicable (see [“Pre-Start Sequence”](#) on page 4-35).
 - ❑ Verify the parameter settings relating to tach error tripping threshold and armature over-current overload protection (see [“Calibration and Verification of Safety Functions”](#) on page 4-41).
 - ❑ Perform the safety tests (see [“Safety Tests”](#) on page 4-43).
 - ❑ Verify that no safety function or circuit remains bypassed prior to releasing the car for normal passenger operation (see [“Before Release to Passenger Operation”](#) on page 4-57).





Quick Topics

- About *iControl*
- Features
- Function
- *iControl*
- *iVIEW*
- *iLAND*
- *iLINK*
- *iCUE*
- *iMONITOR*
- *iReport*
- Load Weigher



iControl Description

1



About *iControl*

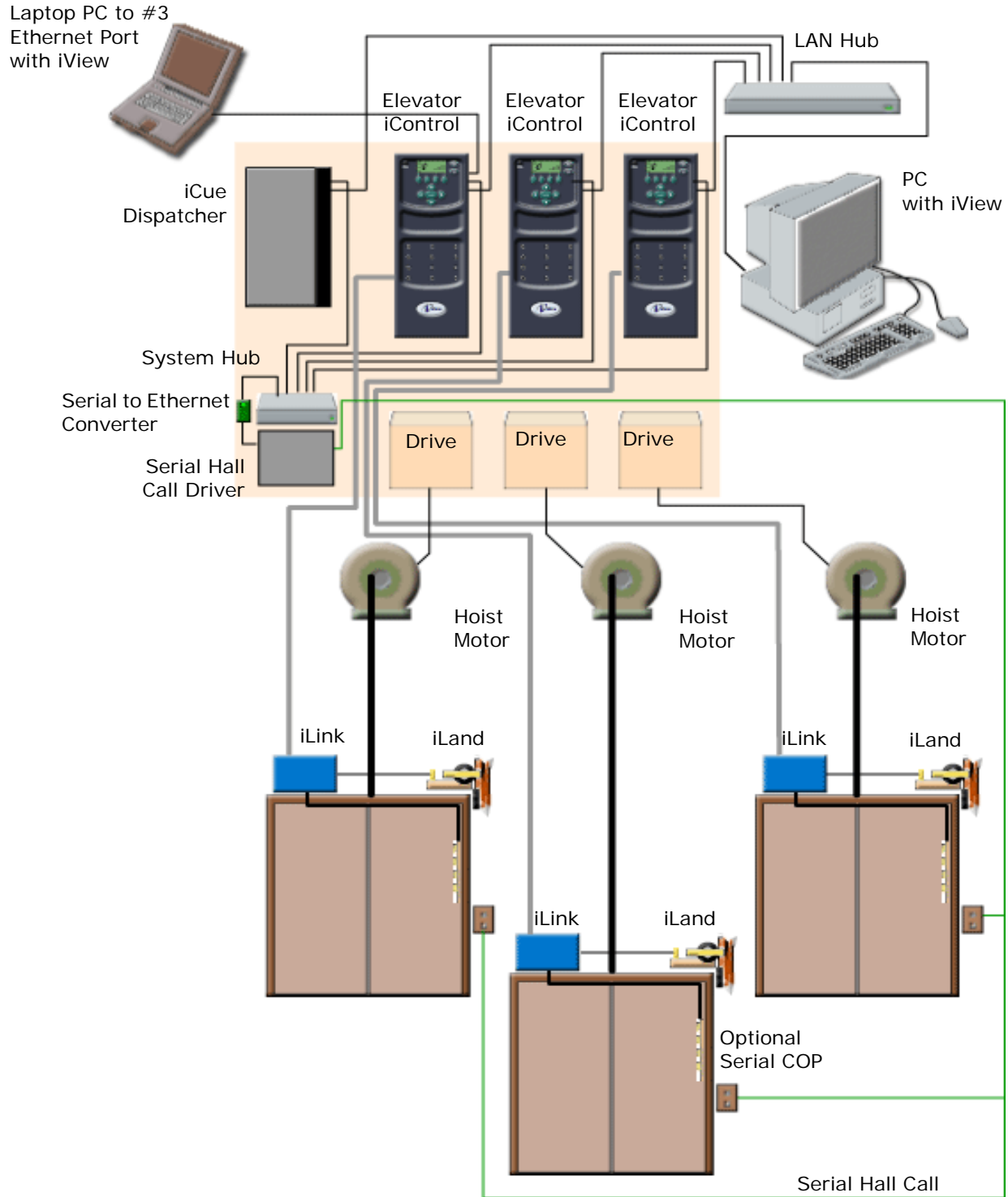
iControl from MCE intelligently integrates and coordinates every element of your elevator installation. Grounded securely in twenty-plus years of MCE experience and innovative design expertise, *iControl* reflects a uniquely-qualified, absolute focus on meeting and exceeding customer expectations.

iControl includes:

- ***iController*** — Next generation *iBox* intelligence for control logic and safety process management designed around proven Power PC microcomputer technology (see [page 1-5](#)).
- ***iView*** — A Windows-native, graphical user interface for direct system analysis, diagnostics, and parameter adjustment (see [page 1-11](#)).
- ***iLand*** — An innovative, maintenance-free landing system unencumbered by tape, struts, or switches (see [page 1-17](#)).
- ***iLink*** — A convenient, cartop, single-point interconnect, converting discrete car signals to economical, dependable, serial communications. Optional serial COP available (see [page 1-18](#)).
- ***iCue*** — The most powerful, intuitive, and adaptable dispatching engine available (see [page 1-19](#)).
- ***iMonitor*** — Centralized, on site or remote system monitoring capability (see [page 1-21](#)).
- ***iReport*** — System logging and report generating tool (see [page 1-22](#)).

The system overview diagram below provides a high-level view of an iControl installation, including peripheral devices and associated iControl equipment.

Figure 1.1 iControl Overview



***iControl* Features**

MCE designed iControl to provide:

- **Compliance:** Fully ASME A17.1 - 2000 compliant. CE and CSA certified.
- **Safety:** Two independent processors verify all safety checks. Safety A is a microprocessor (firmware) and Safety B is a PLD.
- **Support:** Outstanding MCE Technical Support at regional and factory level, electronically or on site.
- **Reduced Installation Expense:** Simplified installation for minimum time and expense.
- **Reliability:** Solid-state construction, minimized point-to-point wiring, integrated design, and non-volatile FLASH memory contribute to exemplary reliability.
- **Scalability:** Flexible capacity and system configuration, scalable control, networked communications capability, and expandable I/O adapt to future requirements.
- **Serviceability:**
 - All user parameters fully field programmable.
 - Secure on site and remote access to user parameters.
 - Supports multiple, simultaneous iView connections for near real-time, diagnostic coordination and support.
 - Real-time status display.
 - Single point location for system control switches.
 - At-a-glance, LED display of 15 most important system functions.
 - Virtual oscilloscope iView display.
 - Informative, near real-time, iView hoistway display.
 - Report generation.
 - On line help for iView.
 - Complete hard copy and electronic (pdf) documentation.
- **Reduced Maintenance Requirements:**
 - Minimal point-to-point wiring.
 - Reliable, D-subminiature component interconnection.
 - Slide-track mounted I/O boards for easy addition or substitution with no reprogramming required.
 - Maintenance-free landing system.
 - Cartop, single-point wiring interconnect, converting discrete car signals to economical, dependable, serial communications.
- **Tuned Acceleration/Deceleration Pattern** for passenger comfort and maximum efficiency.
- **Self-optimizing technology** – the system adapts without intervention, fine-tuning performance over time as use patterns are learned.

***iControl* Function**

iControl provides the modular building blocks required to efficiently address elevator installations ranging from a single car servicing only a few floors to those requiring elevator groups operating according to sophisticated dispatching functionality and servicing up to a design maximum 150 floors. In all cases, MCE can provide iControl components to support system capabilities including remote elevator controller diagnosis and support (iView), remote monitoring capabilities (iMonitor) and a system logging and report generating tool (iReport). iControl components include:

- iController enclosure containing iBox elevator controller, the motor drive, and peripherals specific to the job
- Cartop-mounted [iLand](#) precision landing system
- Cartop-mounted [iLink](#) wiring and interconnect system
- MCE [Serial Hall Call](#) system
- Dispatching — iCue dispatching allows a single group controller to accommodate up to a design maximum 20 cars and 150 floors. iCue can handle myriad dispatching configurations, enabled manually or by automation, and allow configuration of variables sufficient to meet virtually any dispatching need including multiple lobbies, intelligent hall call assignment, parking variations, and automated response to changing traffic conditions within the building. Dispatching can be configured with redundancy for protection against individual system failure or disconnect. Elevator security and emergency power operation are also important iCue capabilities.
- [Graphical User Interface](#) — The MCE iView application runs on any PC or laptop with the Windows 2000 or XP operating systems. Through a standard 10/100 Base-TX Ethernet connection, iView lets you efficiently and easily:
 - View and adjust over 500 controller, motor, and brake parameters
 - Copy controller configurations to files on the computer hard drive
 - Send some or all parameters from a computer file to a controller
 - Monitor system performance in real time
 - Send car and hall calls to evaluate system response
 - Configure extremely flexible dispatching behaviors
 - Use the iView [virtual oscilloscope](#) to tune acceleration and deceleration patterns
 - Configure elevator response to fire, earthquake or other emergency or alternative operating modes
 - With internet access, connect to one controller port while MCE support technicians simultaneously connect to that same controller through a separate port for factory-assisted diagnosis or performance monitoring.
 - Access and print extensive controller logs where important system events are automatically recorded
- [Central Monitoring](#) — MCE iMonitor software allows personnel at local or remote monitoring sites extensive capability to monitor and control safety and security aspects of your installation. Refer to the iMonitor manual, 42-02-S025.
- [Logging and Reporting](#) - iReport is a system logging and report generating tool that allows local or remote analysis of iControl elevator groups from a personal computer running the iReport client software. Because iControl dispatchers are Ethernet capable, you can use iReport to connect to them through a local area network or remotely through internet/modem technology. Refer to the iReport manual, 42-02-S026.

iCONTROL

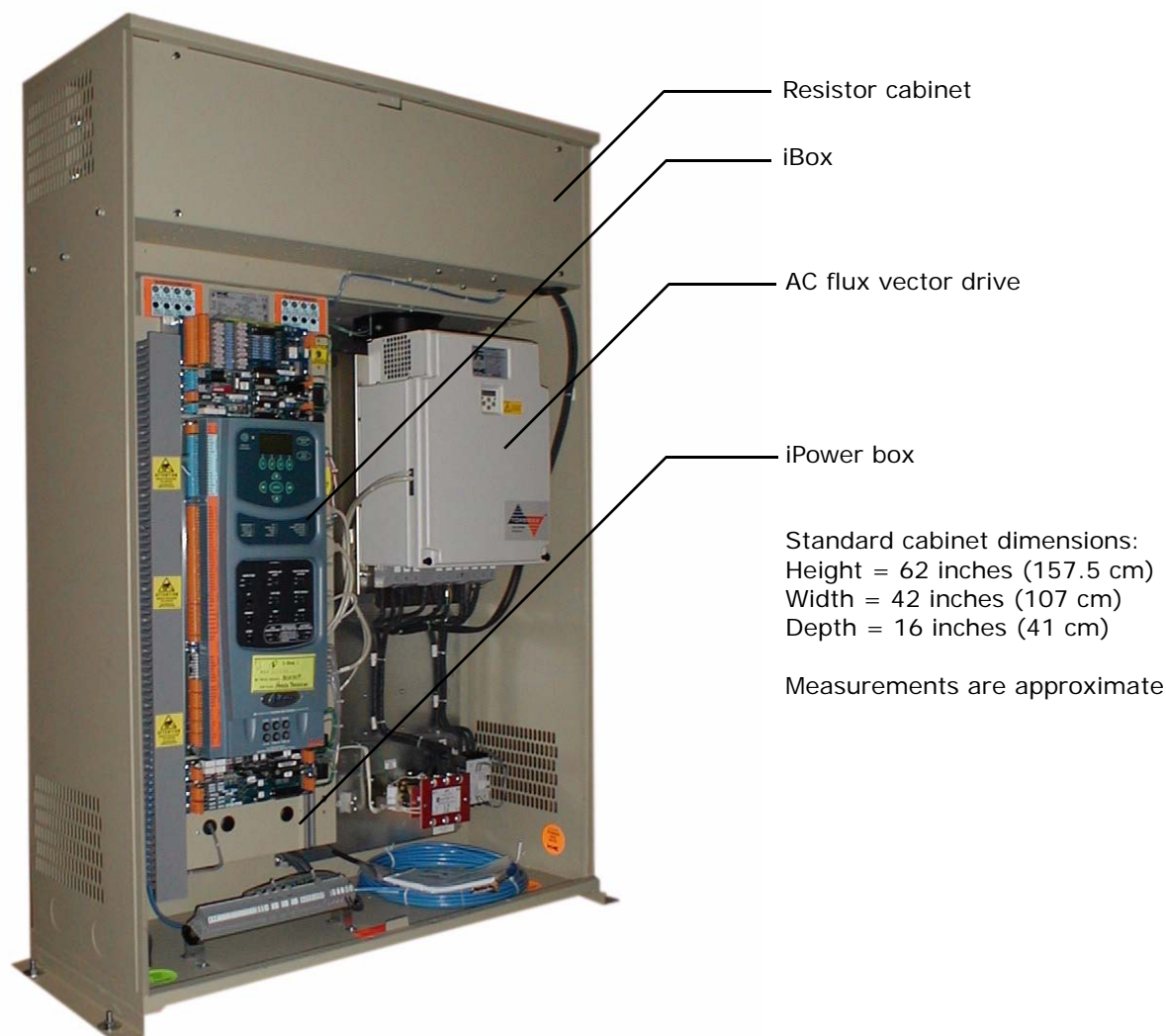
iControl provides the latest in integrated digital elevator control. iControl brings premium performance to elevators using AC motors. Controller parameters can be easily adjusted using MCE iView software running on any Windows 2000 or better personal computer. All parameters can be saved to a file on your computer hard drive, providing a secure archive. iView even allows you to work “offline” in a saved controller file and easily write that data to a controller later.

The sophisticated iControl distance and velocity feedback system is continuously aware of exact car position and speed. The 32-bit processor provides smooth pattern generation for any application— easily accommodating irregularities like short floors. Each iControl includes:

- The *iBox*, including onboard diagnostics
- Flux Vector Drive

The illustration below shows a typical iControl layout.

Figure 1.2 Cabinet Layout (typical)



1



Easy Installation

iControl is designed to make installation and adjustment as simple as possible. Before shipment, each controller is carefully tested against specific job requirements. iControl is shipped from MCE with preset, default adjustment values that generally require little additional adjustment.

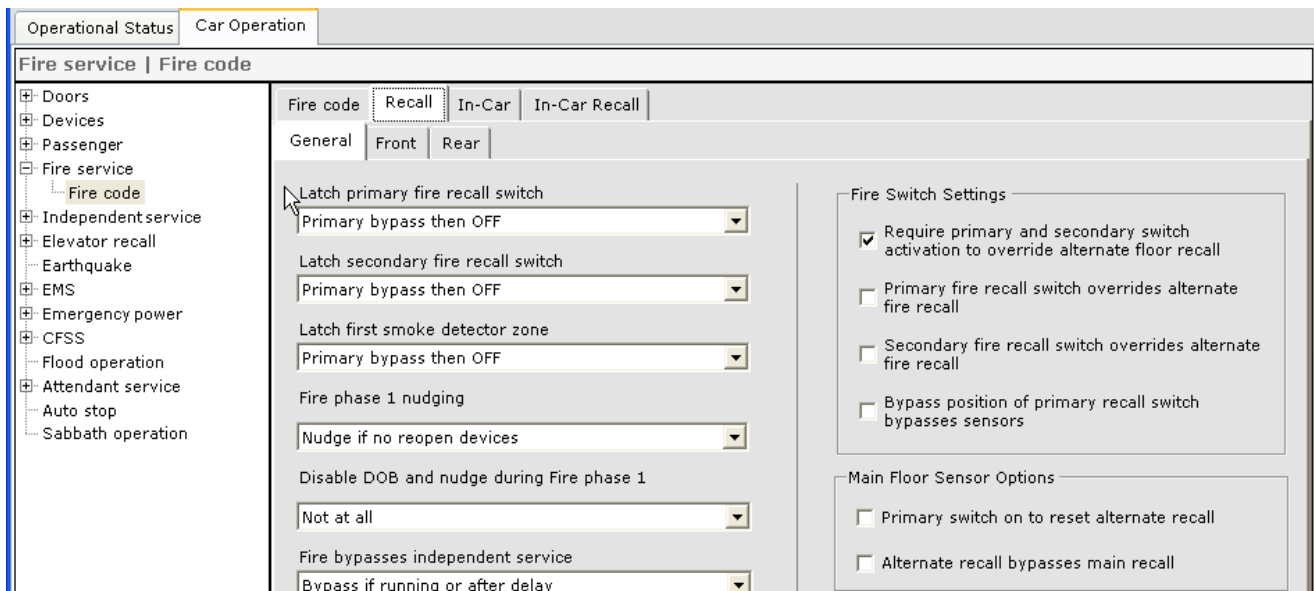
Detailed MCE job prints, specifically engineered for each installation, provide connection-by-connection instruction for mechanics and electricians. Elevator adjusters will find that iControl has the intelligence to automatically “learn” many previously tedious, adjuster-intensive operations including:

- All floor heights to within 0.0469” (1.191mm)
- All Normal and Emergency Terminal switch positions
- High-current brake modulation across the calibration range
- Empty and full car, analog load weigher values at every landing served
- Elevator safety device configuration
- Hoist motor control across the calibration range

iControl makes specific code-compliance as easy as possible too, providing automated fire and earthquake presets for:

- A17.1 (1996 and 2000)
- Title 8
- New York
- Nebraska
- Chicago
- CSA B44-00
- Australia

If necessary for specific job requirements, adjusters have access to detailed, decision-making adjustments within the compliant defaults for various jurisdictions.

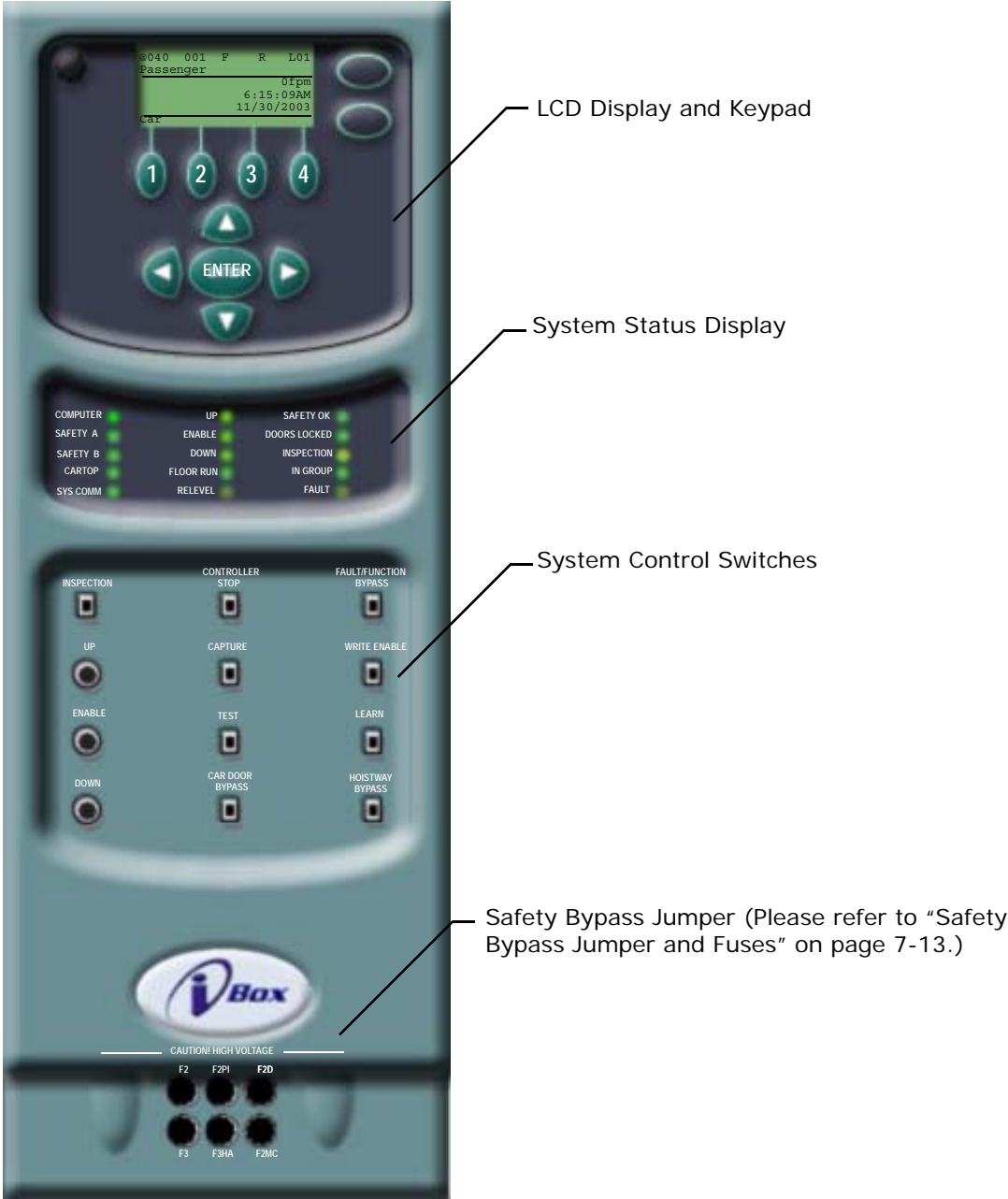


iBox

The *iBox* is the heart of iControl. Built around Power PC technology, the iBox brings flexible, computing power into the elevator machine room. The iBox is an efficient, powerful elevator controller and supports Simplex (Group control parking and dispatching subset) functionality as well. Configured for iControl, the iBox includes:

- Onboard diagnostics display and keypad
- System I/O, control and communications ports (serial, discrete, and Ethernet)

Figure 1.3 *iBox*



LCD Display and Keypad

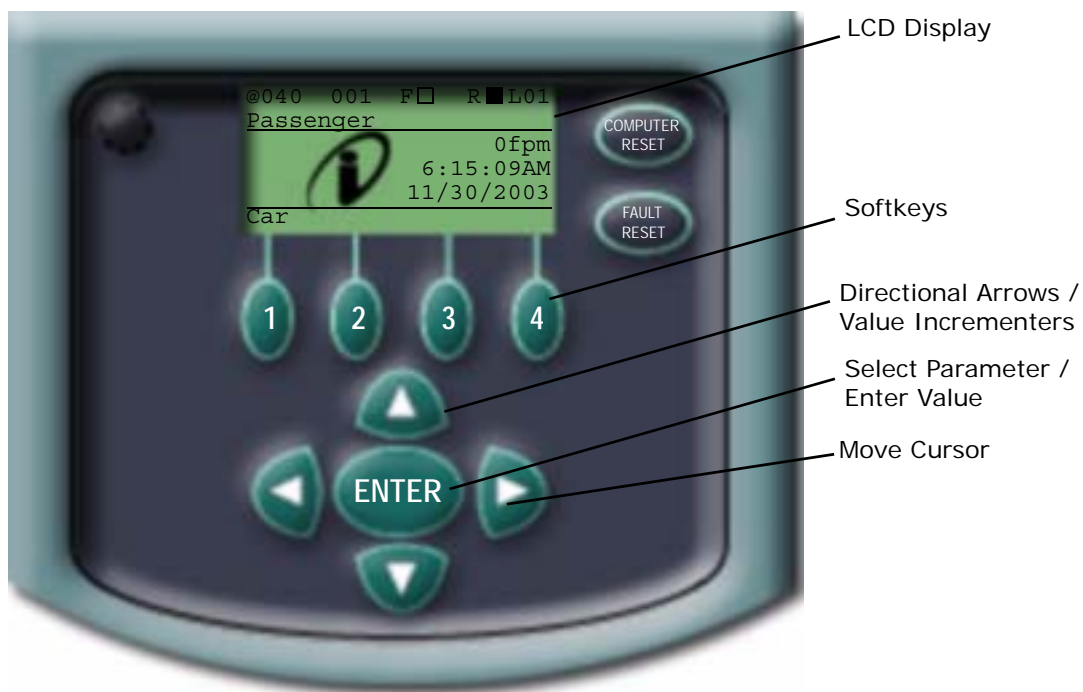
The *iBox* LCD display and keypad allow you to:

- View the status of inputs and outputs
- View and change limited parameter settings
- View and register calls
- View error messages and the system event log

Typically, when you need to view or change system parameters in an iControl, you connect to the iBox through the PC or LAN Ethernet port and use the iView graphical user interface running on a Windows OS PC to easily access, view, or edit any desired parameter.

However, during initial system setup, parameters that allow PC access to your system can be directly accessed and edited through the keypad and LCD display located on the front panel of every iBox. (For detailed information about keypad parameter entry, please refer to [Section 7.](#))

Figure 1.4 iBox Data Entry Keypad and LCD Display



iBox Inputs and Outputs

The iBox is the processing core of iControl. Most of the controller field wiring connects directly to the iBox or to expansion boards plugged into buses at the top and bottom of the iBox. These field connections are primarily along the left side of the iBox (when facing it). Connections to other iControl components (i.e., braking control, motor drive, Ethernet, serial, etc.) are primarily along the right edge of the iBox.

Connections to the iBox are all on pluggable connectors. Serial, Ethernet, and Serial Hall Call connections on the right side of the iBox are primarily pre-molded cable assemblies with “D” or RJ-45 connectors. Connections on the left side of the iBox (position encoder, cartop link, code-mandated car, limit, hoistway, and other field connections) are also pluggable — primarily individual conductors, terminated and locked into connectors that plug into mating connectors on the iBox.

Field wiring (wiring completed by the installer) is addressed in [Sections 2](#) and [3](#) of this guide. The illustration below is only intended to provide an overview of the inputs and outputs to the iBox. A description of every input and output is in [Section 11](#).



AC Flux Vector Drives

The AC Drive control uses flux vector technology. Flux vector technology (sometimes referred to as Field Oriented Control) is a closed loop scheme using an algorithm to adjust the frequency and phase of the voltage and current applied to a three phase induction motor to produce maximum torque from base speed down to and including zero speed. The illustration below shows examples of the TorqMax drives used in MCE iControl AC systems.

Figure 1.5 AC Flux Vector Drives



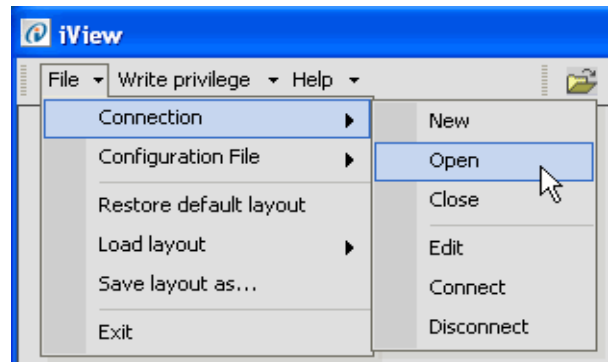
iVIEW Programming and Diagnostic Software

iView is a graphical user interface running on a Windows PC or laptop computer. The computer may be connected directly to the iBox PC Ethernet port or, through a Local Area Network, to the iBox LAN Ethernet port. *iView* provides a wealth of information about the operation of the system and speeds adjustment and troubleshooting.

This section provides an overview of *iView*. [Section 8](#) of this manual provides a more complete description of the *iView* screens. *iView* on-line Help and [Section 9](#) provide the most complete description of the screens.

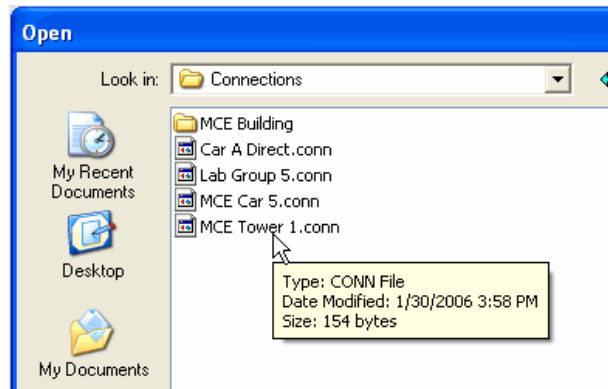
Controller Screen

When you start *iView*, a splash screen appears for a few seconds, followed by the *iView* Controller screen. From the *File* menu, select *Connection* and click *Open*. The Open dialog is displayed.



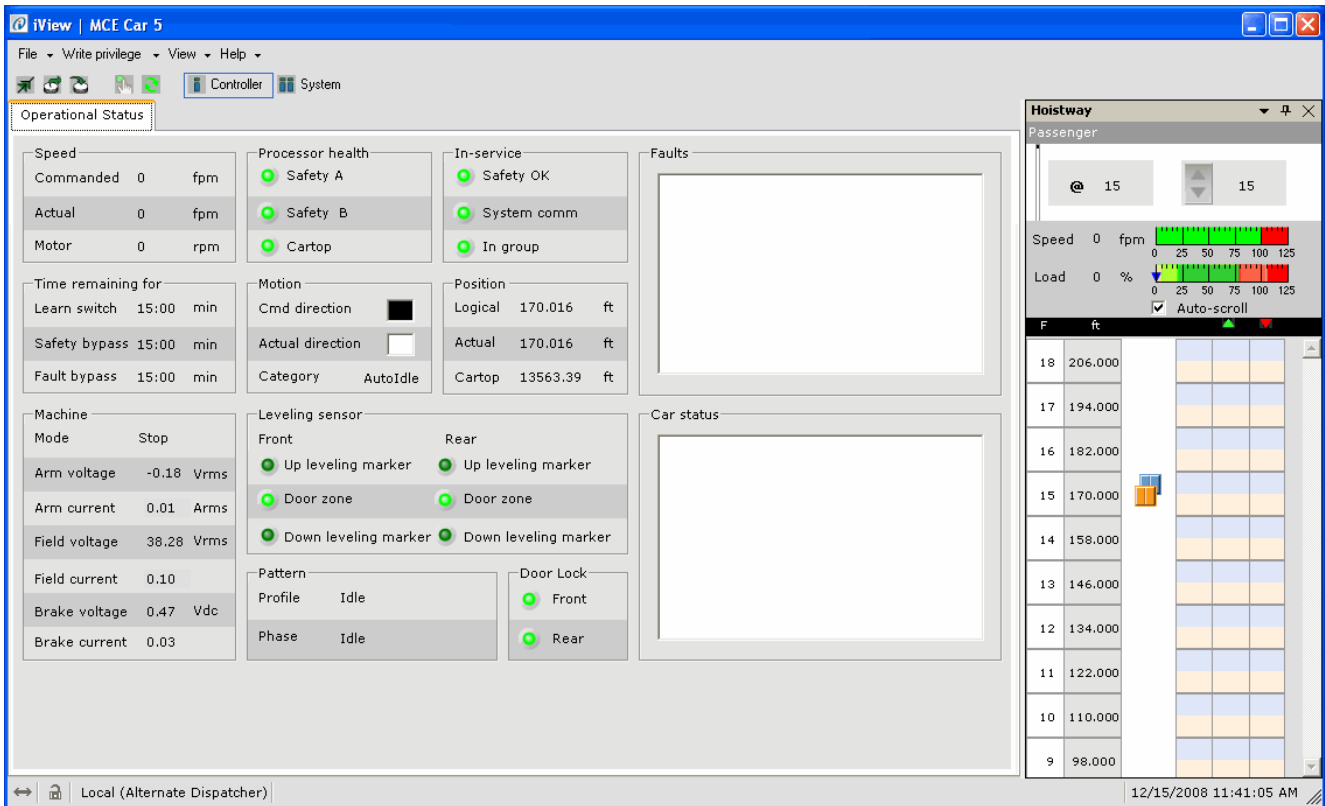
1

Previously created connections appear in the iControl Connections folder. To connect to a controller, double-click one of the listed connections or select the connection and click Open.

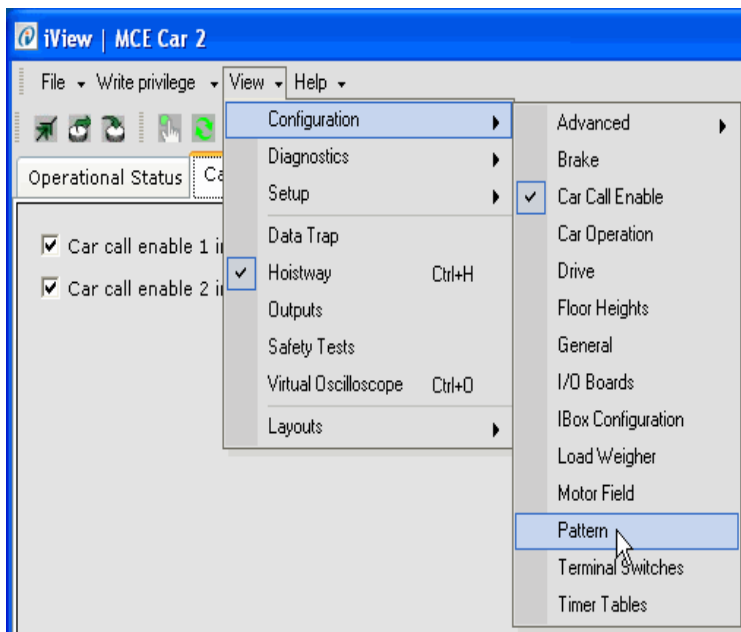




Once the connection has been established, the Operational Status tab and Hoistway window are displayed.



To access the controller’s configuration parameters, click View on the menu bar. Select Configuration tabs and click one of the listed tabs.



Parameter Entry Screens

Parameter entry screens allow you to view and edit all user-adjustable controller parameters. Where appropriate, real time diagnostics capabilities and virtual test equipment facilitate fine performance adjustments and local or remote troubleshooting.

A typical parameter screen, the Pattern/Common tab, is shown below. Before you can edit controller parameters, you must request write privileges (click *Write privilege* on the menu bar, then click *Acquire*) and must be granted those privileges at the controller. (The iBox will display your request and a “yes” response must be entered by pressing the iBox #1 softkey.)

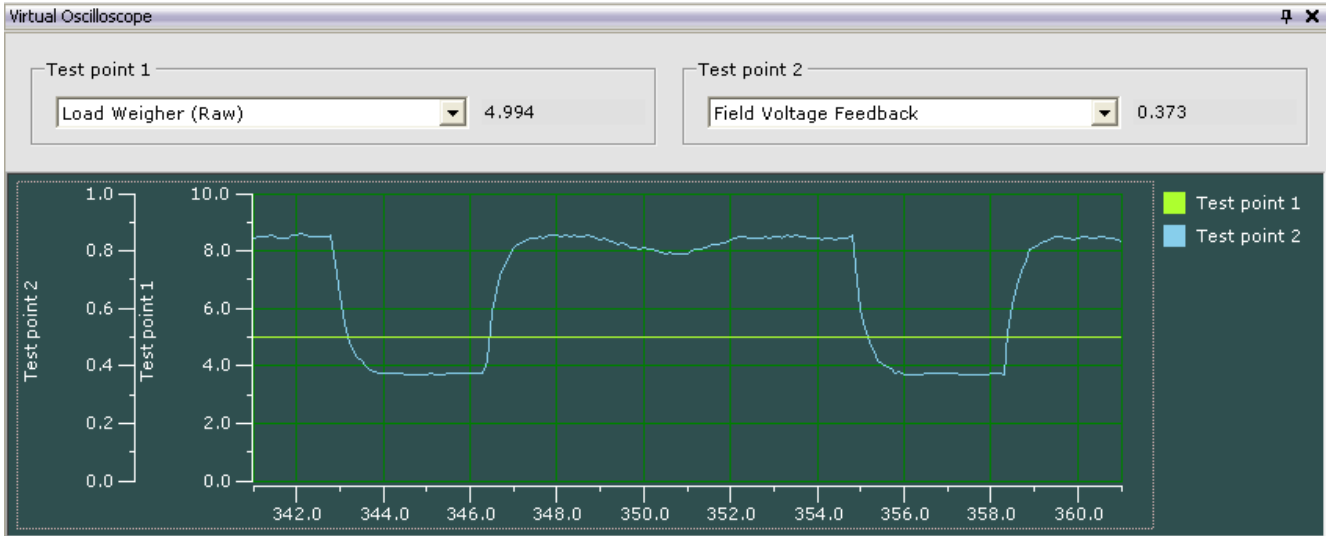
The screenshot shows the 'Pattern' tab selected in the top navigation bar. Below it, the 'Common' sub-tab is active. The main content area is organized into four sections:

- General:**
 - Position Encoder resolution: 256.00 pulses/ft
 - Pattern scaling: 100.00 %
 - Door pre-opening distance: 5.00 in
- Position synchronization:**
 - Terminal:
 - Floor:
 - Preset:
- Leveling:**
 - Leveling speed: 3.96 ft/min
 - Releveling speed: 3.96 ft/min
 - Leveling distance: 0.19 in
 - Releveling distance: 0.50 in
- Dead zone:**
 - Dead zone distance: 0.25 in
 - Relevel dead zone distance: 0.15 in

1

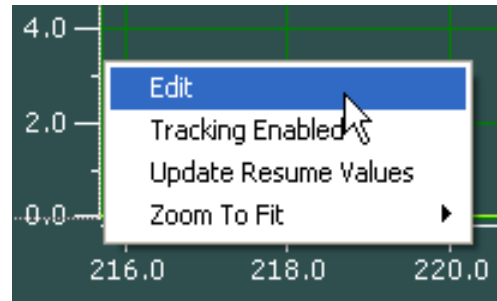
Active Displays

The Virtual Oscilloscope allows you to display and track two signals over time simultaneously. The selected signal values are shown on the Test point 1 and 2 displays and output on the STP 1 and STP 2 physical test points on the iBox. [Please refer to “Controller - Layouts” on page 9-153.](#)



Active Displays may also be relabeled and modified to suit your immediate needs. Once an edited display is closed, it reverts to its default values. Edit a display by right-clicking on a graph or scale and selecting *Edit* from the popup menu. A wide variety of editing choices are available.

You may also choose to enable/disable graph animation (tracking) or zoom the display.



System Interconnect

It can be helpful to have a general understanding of the way the entire iControl system is interconnected. This section contains high-level interconnection drawings for:

- System Interconnection: Basic car control and dispatcher interconnections.
- [iControl Interconnection](#): More detail for car controller interconnections.
- [Cartop Interconnection](#): More detail for cartop interconnections.
- [Dispatcher Interconnection](#): More detail for dispatcher interconnections.

Figure 1.6 iControl System Interconnection

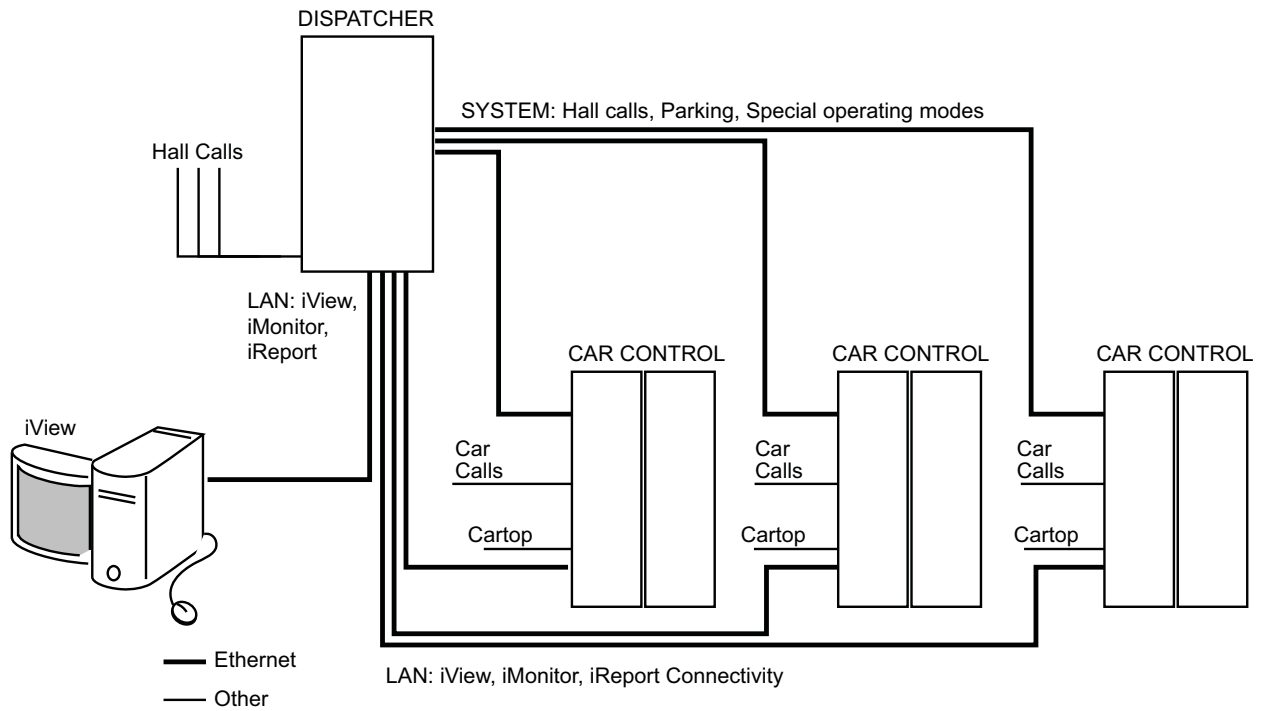


Figure 1.7 Car Control Interconnection

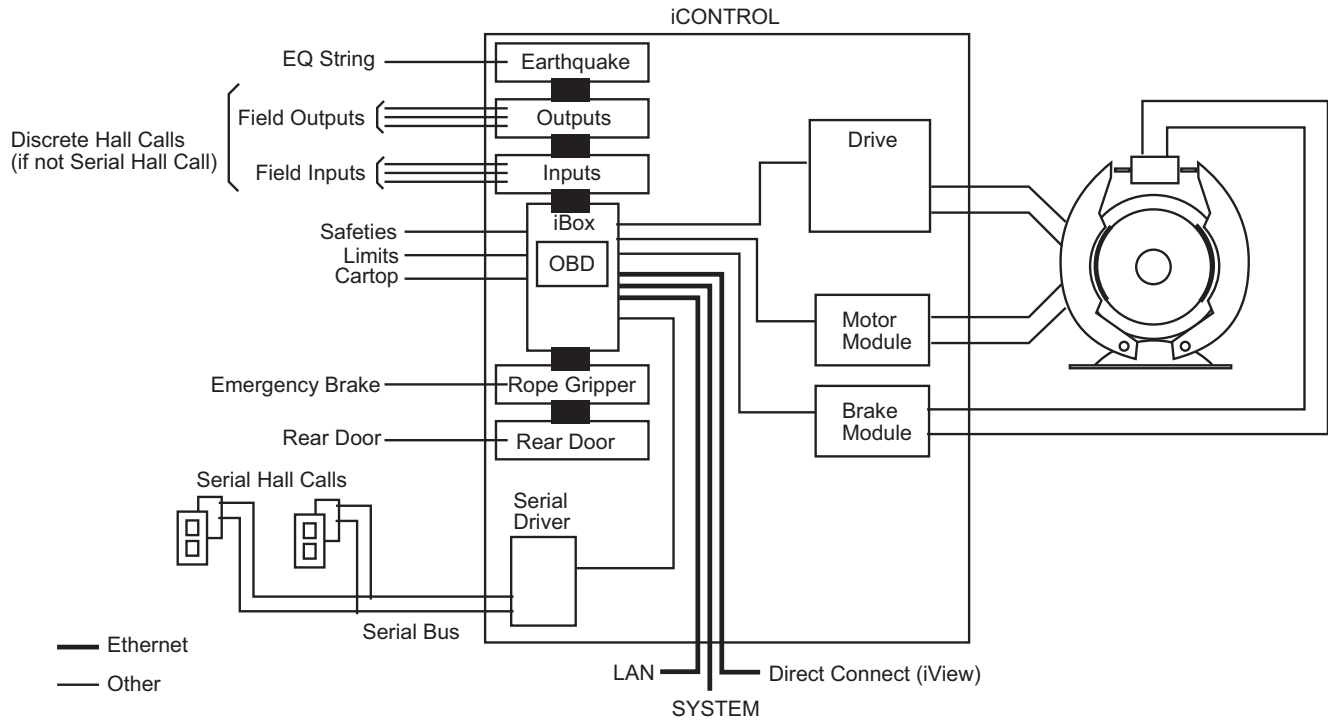
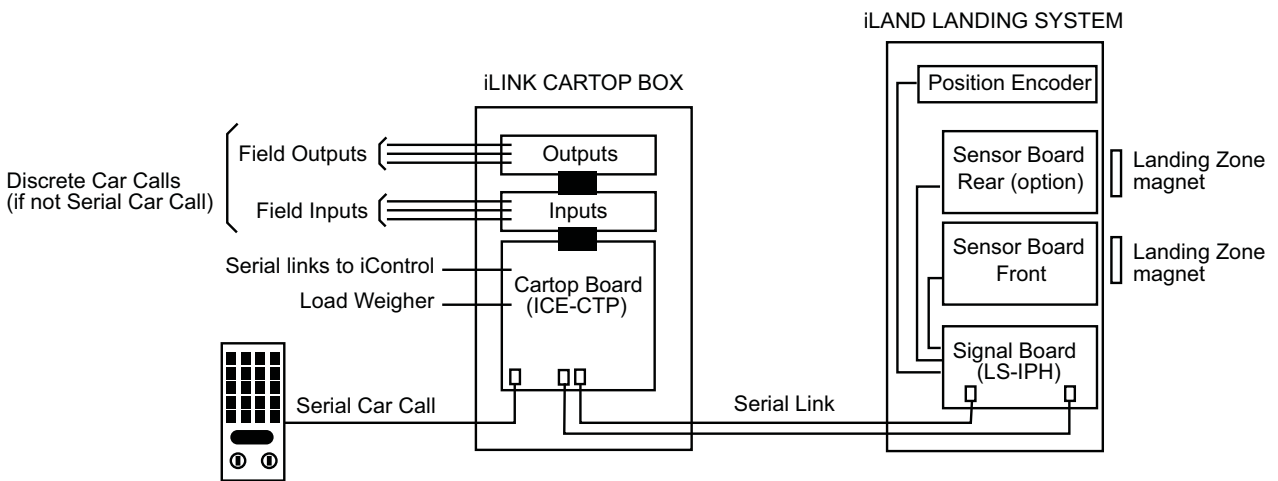


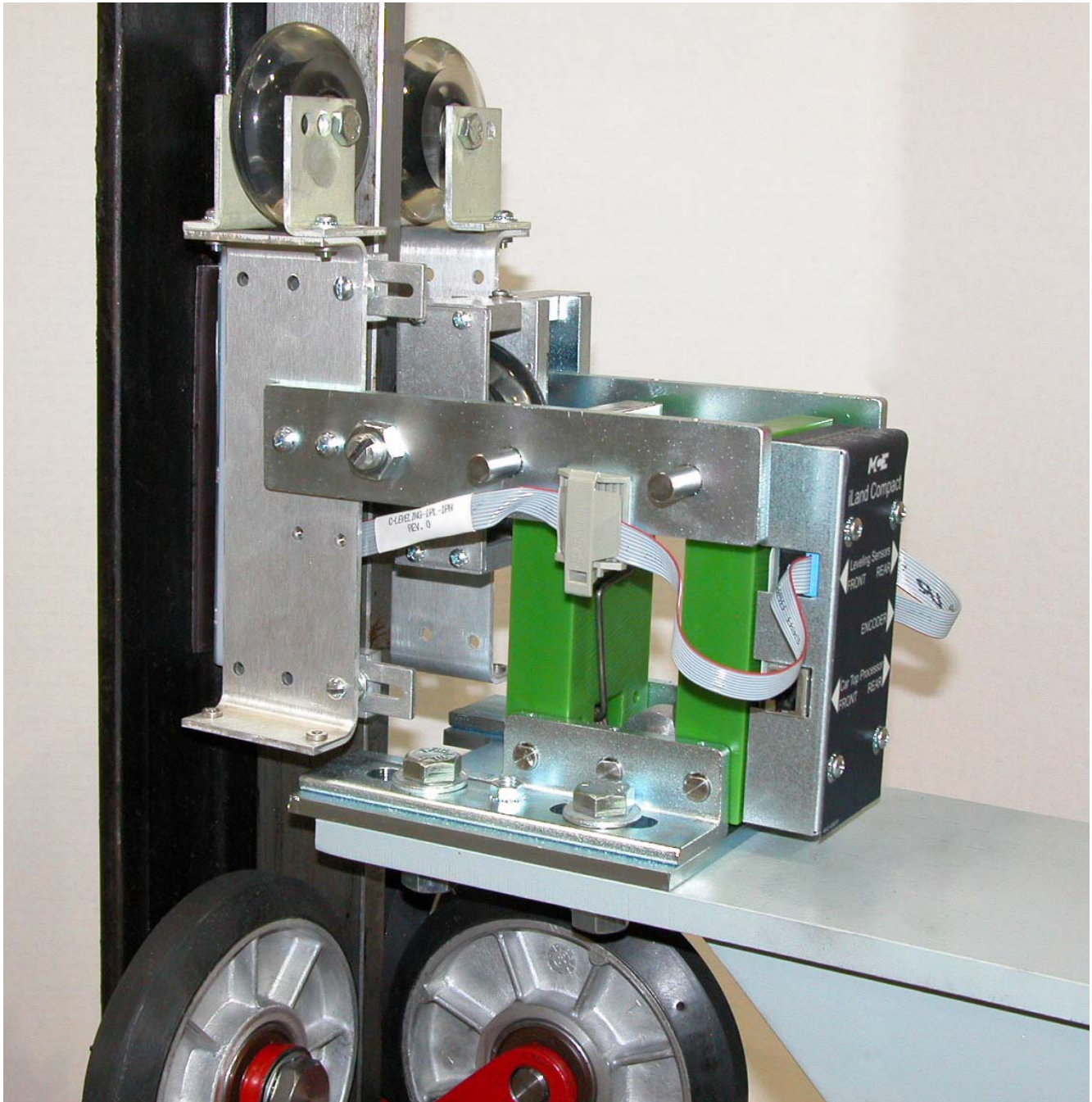
Figure 1.8 Cartop Interconnection



iLand Landing System

The *iLand landing system* provides the feedback required by the controller to determine car direction, speed, and hoistway position. Signals from the landing system are sent to the iControl Safety Processor through the traveling cable.

Figure 1.9 iLand Compact Landing System

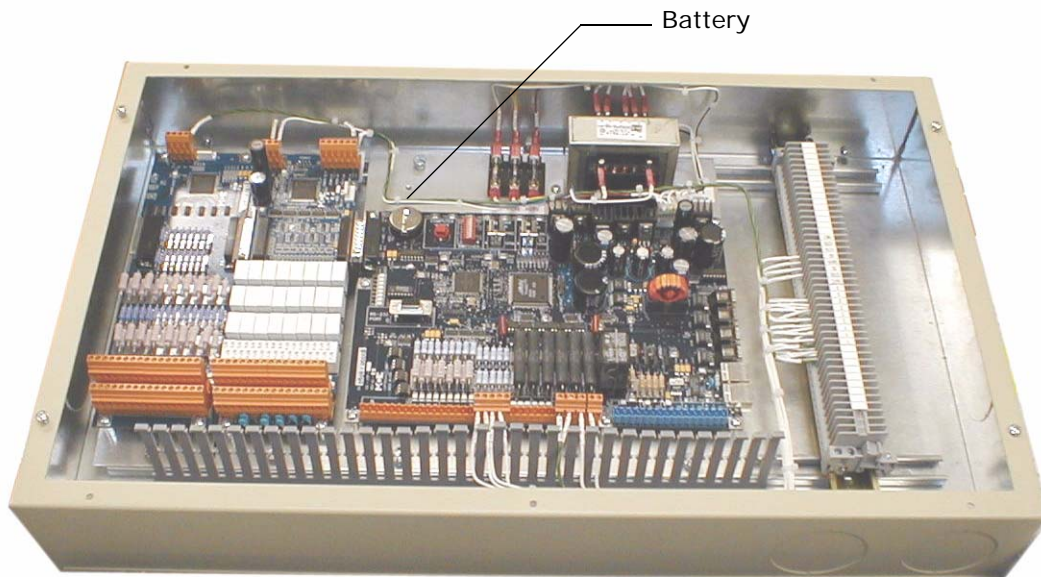


iLand Compact is a rugged, highly accurate landing system. iLand uses an encoder to gauge precise hoistway position and three separate Hall-effect sensors to level the elevator car accurately at each landing. iLand is designed for easy installation and adjustment and to provide maintenance-free service.

iLink Car Top Communication

The iLink car top system:

- Provides power to keep the Car Top Processor and Landing System operational during a power failure until the car comes to a stop, thereby retaining car position information.
- Sends landing System quadrature, door zone, and gate switch status information to the iBox.
- Sends load weigher information to the iBox.
- Sends Car Operating Panel status to the iBox.
- Receives door open/close commands from the iBox and provides them to the door operator.
- Prevents the doors from opening unless car speed is within acceptable limits.
- Provides a communication link to the iBox for other optional car inputs and outputs, e.g., rear door signals and talking and visual position indicators.
- Optional: Relays serial signals between Car Operating Panel and iBox.



Note

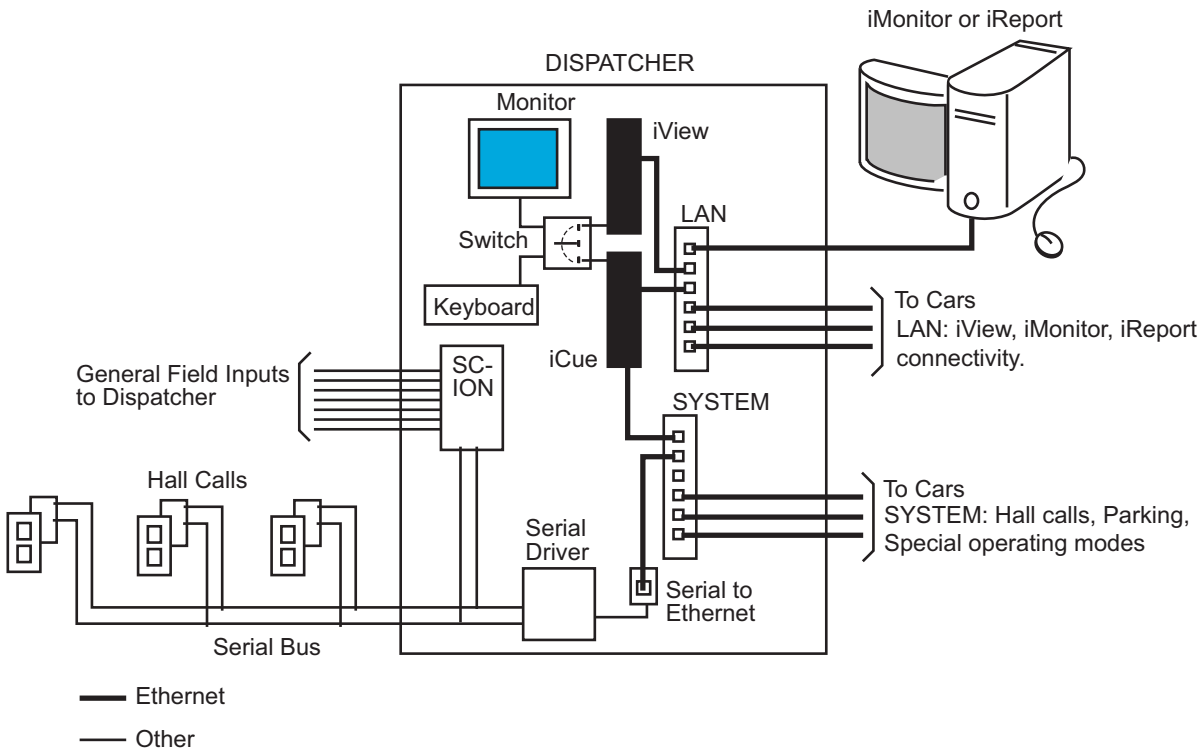
An insulator is installed to disconnect the microprocessor/memory battery to prevent it from running down during storage or shipment. During installation, remove the insulator to activate the battery. (An insulator on the microprocessor/memory battery in the iControl cabinet must also be removed prior to running the controller.)

iCUE Intelligent Dispatching

The iCue dispatching software runs either on a central dispatcher (iCentral), which is a dedicated PC or embedded micro controller, or on a Local/Dispatcher, which is an iController (iBox) that performs both the car control and dispatching functions. Please refer to “An Overview of System Options” on page 10-4. The iCentral option is used for the most demanding installations. iCue dispatching features include:

- Design maximum 150 floors and 20-car group.
- Use artificial intelligence to adapt to and anticipate changing traffic demands.
- Allow users to define up to eight independent configurations each to control Hall Call Eligibility, Parking Assignment, Parking Eligibility, and Operating Mode — and to independently assign control of those configurations across as many as 100 automated timers (timers not yet implemented).
- Use parallel processing to continuously and simultaneously evaluate multiple dispatching scenarios, ensuring that every decision maximizes efficiency.
- Use a dedicated 100 Megabaud network to efficiently handle large data loads.
- Provide an intelligent parking system that allows users to define automated or hybrid operation.
- Support the SmartLINK hall call system, MCE-ready fixtures, and predictive hall-call gong service.

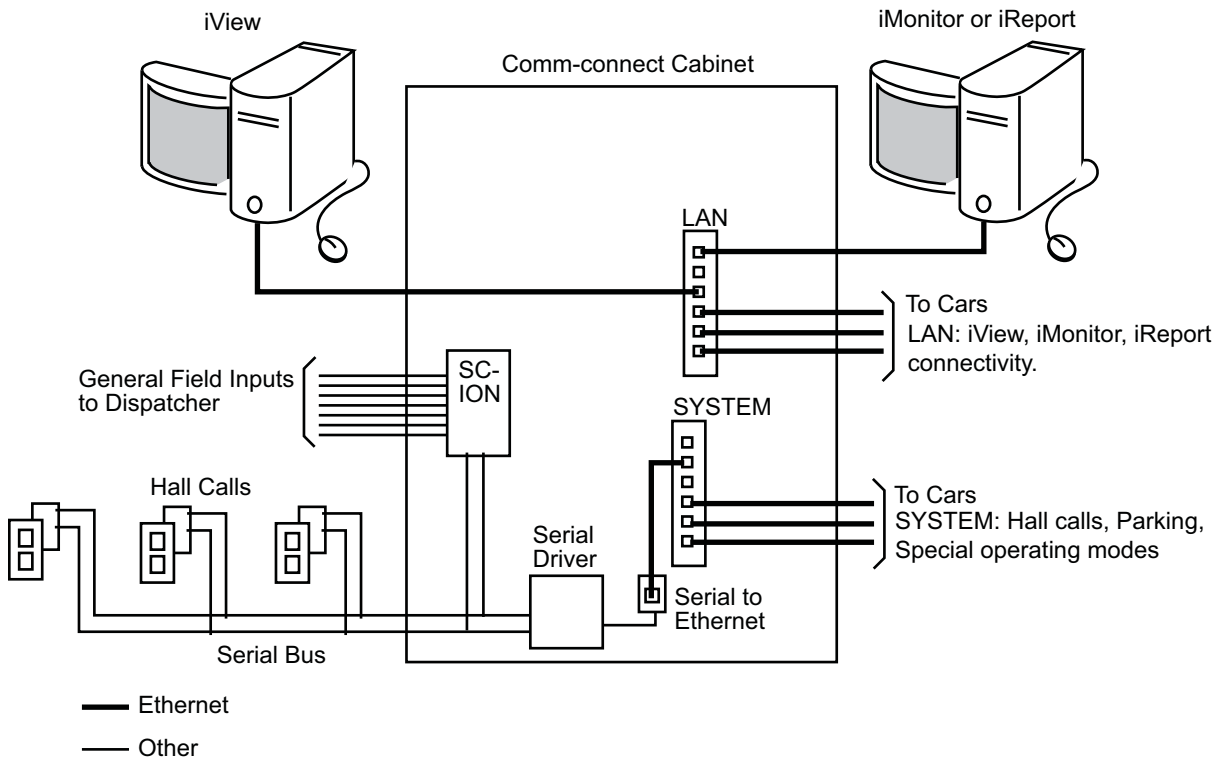
Figure 1.10 Central Dispatcher (iCentral) Interconnection



Local/Dispatcher

Beginning with the December 2006 Release, in addition to performing car control functions, iControllers can assume full dispatching responsibilities for a group of elevators. MCE uses the term *Local* to refer to an individual car that is part of a group, hence the term Local/Dispatcher. One or more Local cars can be designated as an *Alternate Dispatcher*, meaning that they can act as a backup for a central dispatcher or as one of several potential dispatchers for a group that has no central dispatcher. An iController that is currently performing the dispatching functions is called the Local/Dispatcher.

Figure 1.11 Local/Dispatcher (Comm-connect) Interconnections

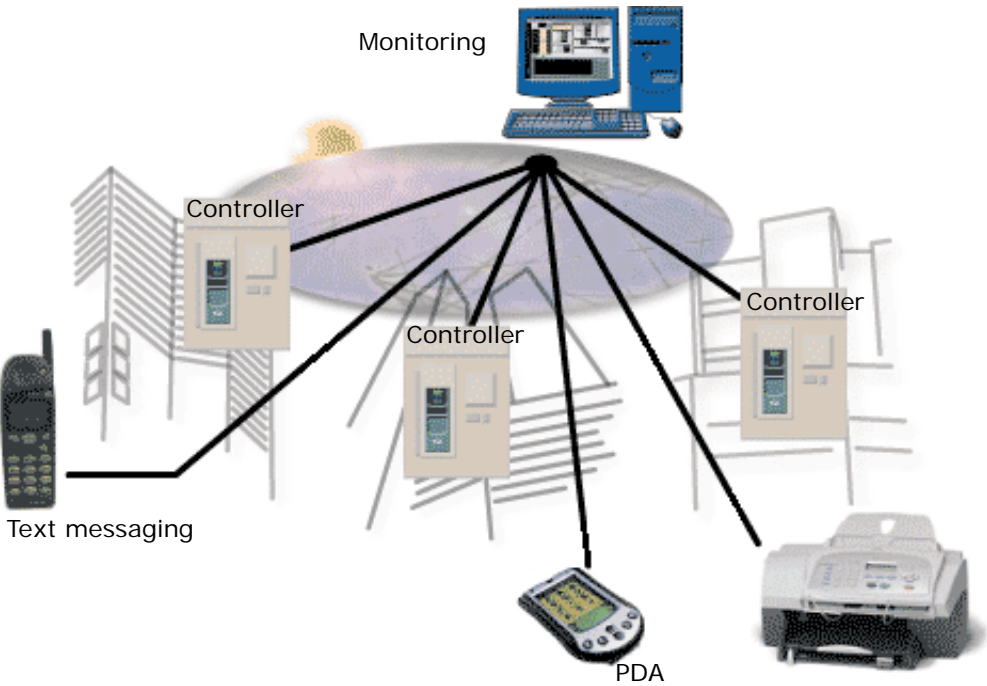


iMONITOR Central Monitoring

Like iView, iMonitor central monitoring software can be installed on any Windows XP compatible personal computer. Through an on-site Local Area Network or remotely through the World Wide Web, iMonitor allows users to immediately gather status from and monitor the performance and safety of any i product elevator installation to which they have been granted access, anywhere in the world.

iMonitor:

- Provides local or remote viewing and control of elevator groups.
- Provides a graphical representation of elevator groups, allowing their activity and status to be quickly and easily viewed.
- Provides remote control. The user may register car and hall calls, control many group security functions, and enable or disable certain elevator operating modes.



***iREPORT* Logging and Report Generating**

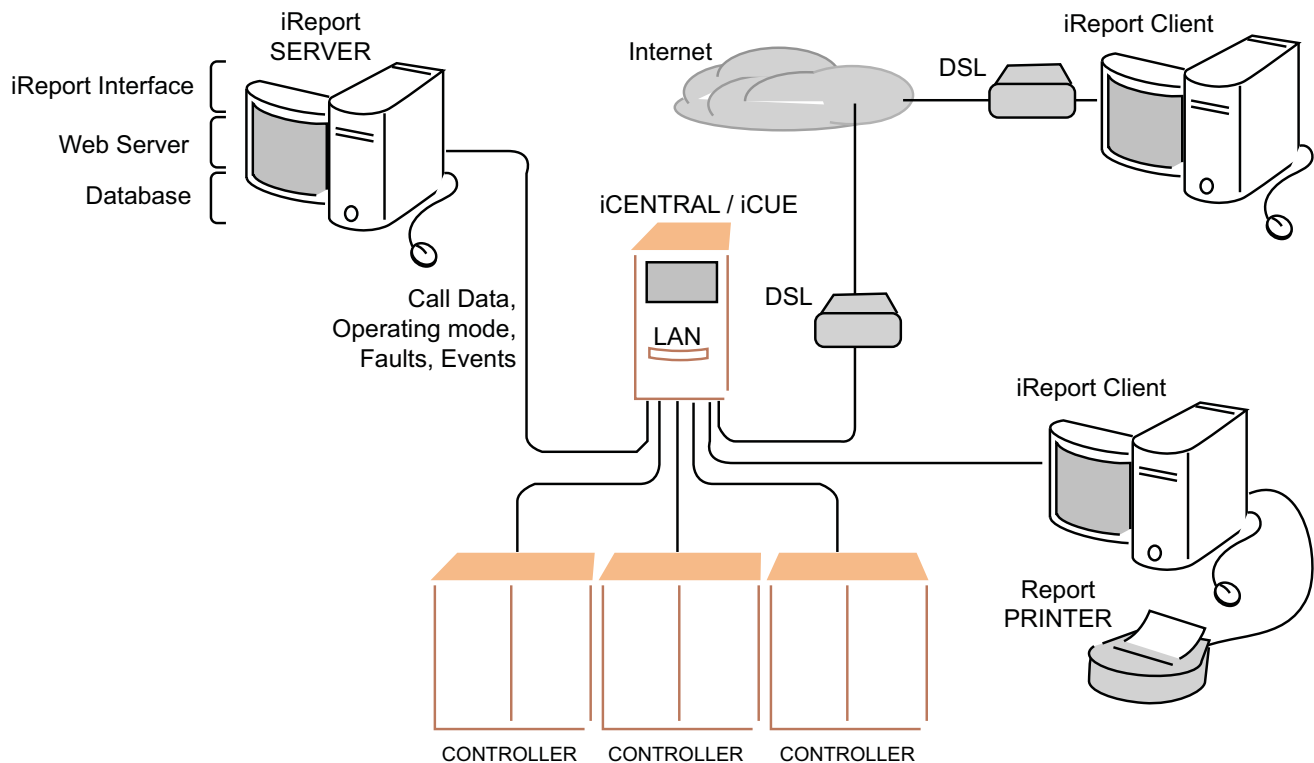
iReport is a system logging and report generating tool that allows local or remote analysis of iControl elevator groups from a personal computer running the Windows XP operating system and iReport client software. Because iControl dispatchers are Ethernet capable, you can use iReport to connect to them through a local area network or remotely through internet/modem technology.

System Description

iReport consists of the iReport server and iReport clients. iControl dispatchers may be connected to iReport directly through a local area network or they may be connected remotely through a DSL or other high-speed ethernet connection and the internet. The dispatcher provides iReport with hall call and car operating mode information. The individual car controllers provide iReport with event and fault notifications.

You connect to and use iReport through the iReport client program on your PC. The block diagram below illustrates a possible system interconnection. Various local and remote connections are possible depending upon system requirements.

Figure 1.12 iReport Simplified Block Diagram



Optional Load Weighing System

iControl uses load weighing information to make intelligent dispatching decisions. If the load weight is very light, the controller can be programmed to limit the number of car calls allowed (anti-nuisance). The controller can be programmed so that at a certain load weight the lobby landing door timer is reduced, thereby initiating the process of moving the car out of the lobby. When the load weight exceeds a pre programmed value, the controller can be instructed to bypass hall calls. And, if the load weight exceeds a predefined maximum, above which it is considered unsafe to move the elevator, the controller can prevent movement. This application typically includes a visual or audible warning to the passengers that the elevator is overloaded.

MCE has three load weigher options:

- Rope Tension (LW-EMCO) from EMCO - measures the tension of the elevator's wire ropes (see [“EMCO Load Weigher Installation and Calibration”](#) on page 5-53).
- Isolated Platform (LW-MCEIP) - measures the movement of the car's isolated platform and can only be used for elevators with isolated platform cars (see [“MCE Load Weigher”](#) on page 5-63).
- Cross Head Deflection (from K-Tech International) - measures the deflection of the cross head beam.





Quick Topics

- In this Section
- Machine Room Prep
- Recommended Tools
- MCE Job Prints
- Cabinet Installation
- Equipment Grounding
- Check for Shorts
- AC Voltage
- Motor, Brake, Encoder
- Safety String
- Applying Power
- Initial Parameters
- Brake Calibration
- Running on Inspection



Construction Mode

2



In This Section

This section provides the information you need to install iControl and get the elevator running in Construction Mode:

- **Machine Room Preparation** (see page 2-4).
- **Recommended Tools and Test Equipment** (see page 2-6).
- **About MCE Job Prints** (see page 2-7).
- **Controller Cabinet Installation** (see page 2-9).
- **Equipment Grounding** (see page 2-14).
- **Check for Shorts to Ground** (see page 2-16).
- **AC Voltage Verification and Wiring** (see page 2-17).
- **Motor and Brake Wiring** (see page 2-21).
- **Velocity Encoder Installation** (see page 2-24).
- **Safety String Wiring** (see page 2-27).
- **Applying Power** (see page 2-29).
- **LAN Connections** (see page 2-32).
- **Initial Parameter Settings** (see page 2-43).
- **Drive Parameter Adjustments** (see page 2-47).
- **Brake Calibration** (see page 2-50).
- **Running on Machine Room Inspection** (see page 2-54).
- **Calibration Actual Car Speed** (see page 2-57).

Before You Begin

Review the following warnings and become familiar with this manual section before beginning work.



Danger

This equipment contains voltages of up to 1000V, rotating motor parts, and driven machinery. The combination of high voltage and moving parts can cause serious or fatal injury. Only qualified personnel who are familiar with this manual and driven machinery should attempt to start up or troubleshoot this equipment. Please observe the following:

- **USE EXTREME CAUTION** — Do not touch circuit boards, resistors, or motor electrical connections without ensuring that the unit is properly grounded and no high voltage is present. Do not apply AC power before grounding the equipment in accordance with applicable local codes, the job prints, and instructions contained in this manual.
- **BE CERTAIN** that any possible violent motion of the motor shaft and driven machinery, caused by improper control operation, will not cause personal injury or damage. Peak torques of up to ten times rated motor torque can occur during a control failure.
- **HIGH VOLTAGE** may be present on the motor and drive whenever AC power is applied, even if the motor is not rotating.
- **BEFORE BEGINNING WORK**, read these instructions all the way through to become familiar with the procedures. Proceed cautiously. These instructions assume adequate electrical troubleshooting experience. Follow the procedures carefully and, if the elevator does not respond correctly, check the circuits and obtain necessary assistance.

Overview of Construction Mode

Construction mode operation allows the car to be run on Machine Room Inspection and Cartop Inspection with a bare minimum of field wiring installed. For Construction Mode operation, only the following are needed to run the car:

- Motor, brake, and drive
- Velocity encoder/tachometer
- Safety String
- Normal limit switches
- Door locks and door position monitor (if used)
- The Construction Mode option (iView/Safety screen or iBox/Controller Setup/Safety/Construction Mode) must be enabled to run the controller in Construction mode.

The cartop wiring interconnect box (iLink) is not required for Construction mode operation. Instead, temporary wiring may be used to “bypass” the cartop safety string.

Required Connections The following connections are necessary to run the car on Construction Mode:

- Motor, Brake, and Drive
- Velocity Encoder or Tachometer
- SAFH, GOV, ESC, Rope Gripper (if enabled)
- SAFC (provide temporary Emergency stop switch between SAFH and SAFC if iLink is not yet installed)
- UNTD and DNTD (Up and Down Normal Limit Switches)
- GS, DLMS, DLAT, DLAB, DPM (Verify the iView/Safety Configuration screen settings for these options)
- INCT, ICTU, and ICTD
- Emergency Power Input

Connections not required for Construction Mode operation include:

- Cartop Communication (TX, RX)
- Quadrature signal (DP1, DP2)
- EQ signal
- Terminal Switches (U/DNTx and U/DETS)
- Fire Sensor
- DZ, ULM, DLM

Please refer to [“iBox Field Connections”](#) on page 11-7 for definitions of iBox inputs and outputs.

Faults While operating in Construction Mode, faults may be generated because the installation is not yet complete. These may be disregarded in this phase and include:

- Invalid Front and/or Rear Doors
- Terminal Sync
- System Sync
- Floor Sync

Machine Room Preparation

When preparing the machine room for elevator controller installation, consider:

- Equipment location
- Machine room environment
- Ethernet and internet access

Equipment Location

When choosing equipment location, consider:

- Adequate working space for comfort and efficiency.
- Logical arrangement, taking into consideration other equipment in the machine room and routing of electrical power, control, and Local Area Network (10/100 Base TX) wiring.
- Do not install equipment in a hazardous location.
- Installing a telephone in the machine room is desirable as it makes remote diagnostics and adjustment assistance more readily available.
- Wiring the machine room for internet access will allow MCE technical support to use the iView application to remotely view system parameters, diagnose problems, and assist you in adjusting elevator controller settings.
- If any areas in the machine room are subject to vibration, they should be avoided or reinforced to prevent equipment from being adversely affected.
- Provide adequate lighting for the control cabinets and machines. A good working space such as a workbench or table should also be provided.

Environmental Considerations

- Ambient temperature should remain within 32° to 104° Fahrenheit (0° to 40° Celsius). Temperatures outside these guidelines may be tolerated, but will shorten equipment life. Adequate ventilation is required. Air conditioning may be necessary.
- The air in the machine room should be free of excessive dust, corrosive elements, and excessive moisture. A NEMA 4 or NEMA 12 enclosure can help meet these requirements if machine room conditions are inadequate. If the machine room has open or unglazed windows or other direct outside openings, place equipment cabinets far enough from them so that severe weather does not damage the equipment.
- Very high levels of radio frequency (RF) radiation from nearby sources should be avoided. RFI may interfere with controller components, degrading elevator performance. Using hand-held communication devices close to the controller may also cause interference. Interference from permanently installed radio transmitting antennas is not common.
- Power line fluctuation should not be greater than $\pm 10\%$.

Ethernet and Internet Considerations

iControl takes maximum advantage of the reliability and remote support benefits afforded by Ethernet and internet technologies. The iBox supports three Ethernet connections:

- The #3 port is for direct local connection of a laptop or desktop PC for elevator control configuration, program uploading, system diagnosis, or parameter adjustment using MCE iView software. Fixed IP address: 192.168.193.001
- For multi-car, centrally dispatched installations, the #2 port provides dedicated, fast 100 Base-TX connection between iBoxes. In these installations, the required Ethernet hub is provided by MCE and mounted in the iCentral cabinet. See the table below for the factory default.
- The #1 port allows the elevator controller to be connected to a 10/100 Base-TX Local Area Network (if available). This allows a single PC to be used to administer and monitor multiple elevator controllers using iView software. See the table below for the factory default address for this port.

Through a net modem, ISDN, DSL or other internet access, this port may provide remote access to the controller. This access allows MCE technical support staff to view controller parameters at the same time you view them through your LAN or direct/local connection. Elevator parameters are protected from meddling or accidental change because in order to write data to a controller, permission must be granted in the machine room.

For installations not requiring a central dispatching capability or for single car installations, Ethernet or internet connectivity may not be required.

If you want to take advantage of Ethernet or internet connectivity benefits, the machine room must be appropriately wired. Most commercial buildings use Ethernet Local Area Networks that can readily be extended to accommodate machine room access.

Table 2.1 System, LAN, & 3=PC TCP/IP Addresses

Hub	Group	Group IP, Primary & Backup	Car ID	Car IP	System/Serial Hall Call Bus 1 - 4	iView PC
System	all	192.168.192.201-202	1-20	192.168.192.001-020	192.168.192.211-214	
LAN	A	192.168.191.201-202	1-20	192.168.191.001-020		192.168.192.101-200*
LAN	B	192.168.191.203-204	1-20	192.168.191.021-040		
LAN	C	192.168.191.205-206	1-20	192.168.191.041-060		
LAN	D	192.168.191.207-208	1-20	192.168.191.061-080		
LAN	E	192.168.191.209-210	1-20	192.168.191.081-100		
Port #3 = PC (iBox ONLY), NO HUB				192.168.193.001		

*192.168.191.101 is typically used for the iView PC.

Recommended Tools and Test Equipment

For proper installation, we recommend that the following tools or their equivalents be used:

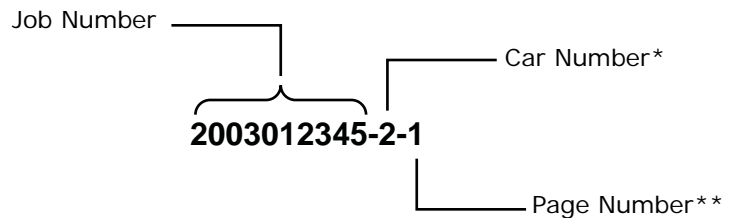
- Digital multi-meter, Fluke series 75, 76, 77 or equivalent.
- Oscilloscope, preferably storage-type (a storage scope is mandatory for high speed gearless adjustment).
- Hand-held tachometer.
- AC clamp-on ammeter.
- Assorted soldering tools, rosin flux solder, electronic side cutters, long-nose pliers, flashlight and the MCE screwdriver provided with controller.
- Test weights.
- Telephone connections and hand-held radios to support any necessary communication.

About MCE Job Prints

MCE Job Prints are technical drawing and instruction sets specifically generated for and accompanying each MCE installation. The job prints provide technical information and instruction specific to the installation using the survey information collected when the job was specified and initiated. Job prints are frequently referenced by installation instructions and are a critical resource for elevator installation and maintenance technicians.

Become familiar with the following information as well as the wiring prints provided with this control system.

Drawing Number Format - Each print has a drawing number in the title block. The drawing number contains the job number, car number and page number (see examples). In this manual the drawings will often be referred to by the last digit of the drawing number (page number).



* Car Number "G" = Group Controller

** Page Number "D" = Drive Page, CT= iLink

** An "X" after the page number = auxiliary page

Note

Drawing Name: Some drawings have a drawing name directly above the title block or at the top of the drawing. The drawing name may also be used to refer to a particular drawing.

2

MCE job print drawing numbers use the format "Job Number — Car Number — Drawing Identifier." Thus they are specifically "keyed" to particular installations. It makes using and understanding job prints much easier if you take some time to review the job prints package before beginning controller installation. Drawing identifiers and the information you can expect to find on that job print drawing are listed below:

- N: Nomenclature drawing — schematic symbols, wire gauge information, circuit board names and symbols.
- INT: iLink cartop wiring interconnect box to controller connections.
- CVR: iBox controls and indicators.
- 1: AC power connections, power bus information.
- 2 through nn: iBox/controller wiring.
- CC: Contact Count drawing — System contact/relay information.
- SH: Serial Hall Call wiring.
- CT: Cartop wiring (iLink cartop wiring interconnect box).
- COP: Car Operating Panel to cartop box (iLink) wiring.
- CW: Car to cartop box (iLink) wiring.
- MRW1, -MRW2: Machine Room and Hoistway wiring.
- D1, -D2, -D3, -D4: Controller and drive wiring.


Note

Depending on your installation, you may have extra sheets of particular drawings. Extra sheets are indicated by an “x” following the drawing identifier. You may also have different or additional equipment in your installation accompanied by different or additional drawings in your job prints. In any case, take the time to become familiar with the job prints before beginning work.

Symbols

Every job print set contains a drawing depicting and describing schematic and other symbols used in the job prints. Review this page to acquaint yourself with symbols and their meanings.

Nomenclature

MCE documentation may refer to PC boards and other components by MCE part number. The following table lists these numbers and provides a brief description of each. Your installation may not use all of the boards listed.

Table 2.2 Component Nomenclature

Symbol	Component	Description
00	ICE-IMP	iBox primary microprocessor board.
01	ICE-SAF	iBox safety board.
02	ICE-IRB	iBox Relay board.
03	ICE-IEQ	Earthquake and counterweight derailment sensor board.
04	ICE-SF-X	Serial Fixtures interface board (displays, annunciators, etc.).
05	ICE-IRD	Rear Door board.
06	ICE-RG	Rope gripper board. Used when a rope gripper is supported.
07	ICE-COP	Serial Car Operating Panel board.
08	ICE-CTP	iLink (Cartop) primary microprocessor board.
09	ICE-EB	Emergency Brake Board
32	ICE-MIAC	Input expansion board. Used as needed in iControl and the iLink cartop box to support equipment inputs.
50	ICE-MOT	Output expansion board (not currently used).
51	ICE-MOR	Output expansion board. Used as needed in iControl and the iLink cartop box to support equipment outputs.
80	ICE-LCB	Low Current Brake board, used in low current braking applications.
85	SC-ION	Serial Control I/O Node board.

Controller Cabinet Installation



Note

It is very important that you review the wiring guidelines in this section before bringing wires into the controller.



Caution

When drilling or cutting access holes or during other machining, do not allow any metal chips to fall into the electronics. Keep drive or other covers in place while wiring to prevent damage to components.

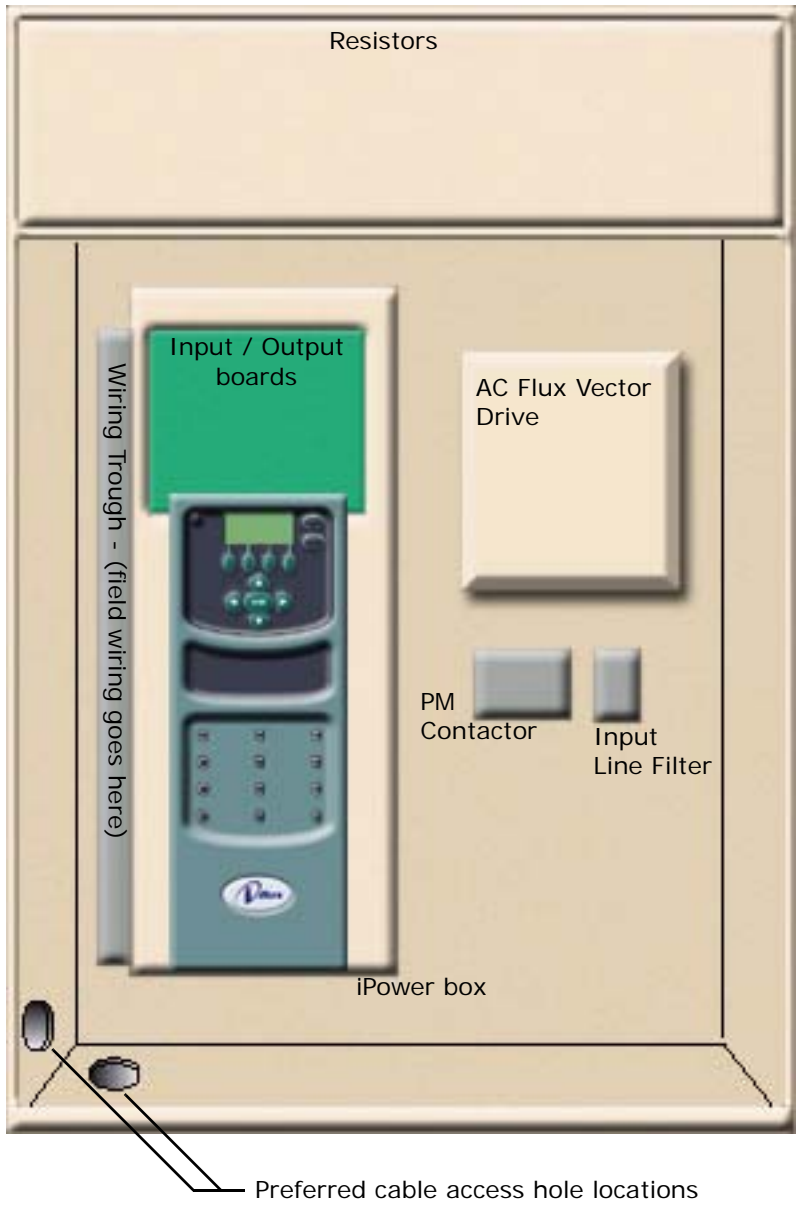
1. Mount cabinets securely to the machine room floor.
2. Cut holes to permit bringing wires in as shown in the following illustration.

MCE applies labels inside the cabinet to identify suggested wiring hole locations. The MCE controller cabinet does not require rear access.

- Field wiring should enter the cabinet from the side at the lower left corner or from the bottom directly under the wiring trough. **The wires must be routed through the wiring trough on the left side of the controller cabinet in a way that allows the power box door to open fully.**
- All conductors entering or leaving the controller cabinet must be through conduit. High voltage, high current conductors, such as power conductors from the fused disconnect or isolation transformer, must be separated from control wires. It is essential that Tachometer/Velocity Encoder control wires be routed through a separate conduit away from high current conductors.
- The traveling cable must have at least four twisted shielded pairs to be used for the position pulser quadrature signal and the *iLINK* communication link from the Car Top Processor board (ICE-CTP) to the *iBox* Safety Processor board (ICE-SAF). The shielded cable should be used all the way to the controller. If there are more shielded pairs still available, route the ULM, DLM and DZ signals from the *iLink* Car Top Processor board through a shielded pair (especially if the building has more than eight floors). The shields must be grounded at both ends by connecting them to a “SHLD” terminal.

2

Figure 2.1 Cable Access



Note

PC boards can be easily damaged by electrostatic discharge (ESD). Use a properly grounded wrist strap or other static protection when handling, touching, or making connections to PC boards.



Overview of Typical Connection Locations

The following diagram provides a general overview of component and connection locations inside iControl. Because circuit boards in iControl are connected along a common bus, they may be arranged differently or different boards may be used in different installations. Therefore, specific connections might be in a location other than the one shown. This is only a general overview. This is only a general overview. Use it in conjunction with the job prints when making electrical connections. [Please refer to “iBox Field Connections” on page 11-7](#) for a list of specific inputs and outputs.

Field wiring for hoistway, car, landing and load weighing systems, and discrete hall calls are all on the left edge of the controller.

High voltage connections are primarily on the right side of the cabinet under the motor drive.

Outputs used to drive customer peripherals. Signal/Pin assignments made in iView screens.

Customer peripheral inputs (card readers, etc.) Signal/Pin assignments made in iView screens.

CE serial fixture interface. Floor indicators, etc.

Earthquake sensor I/O.

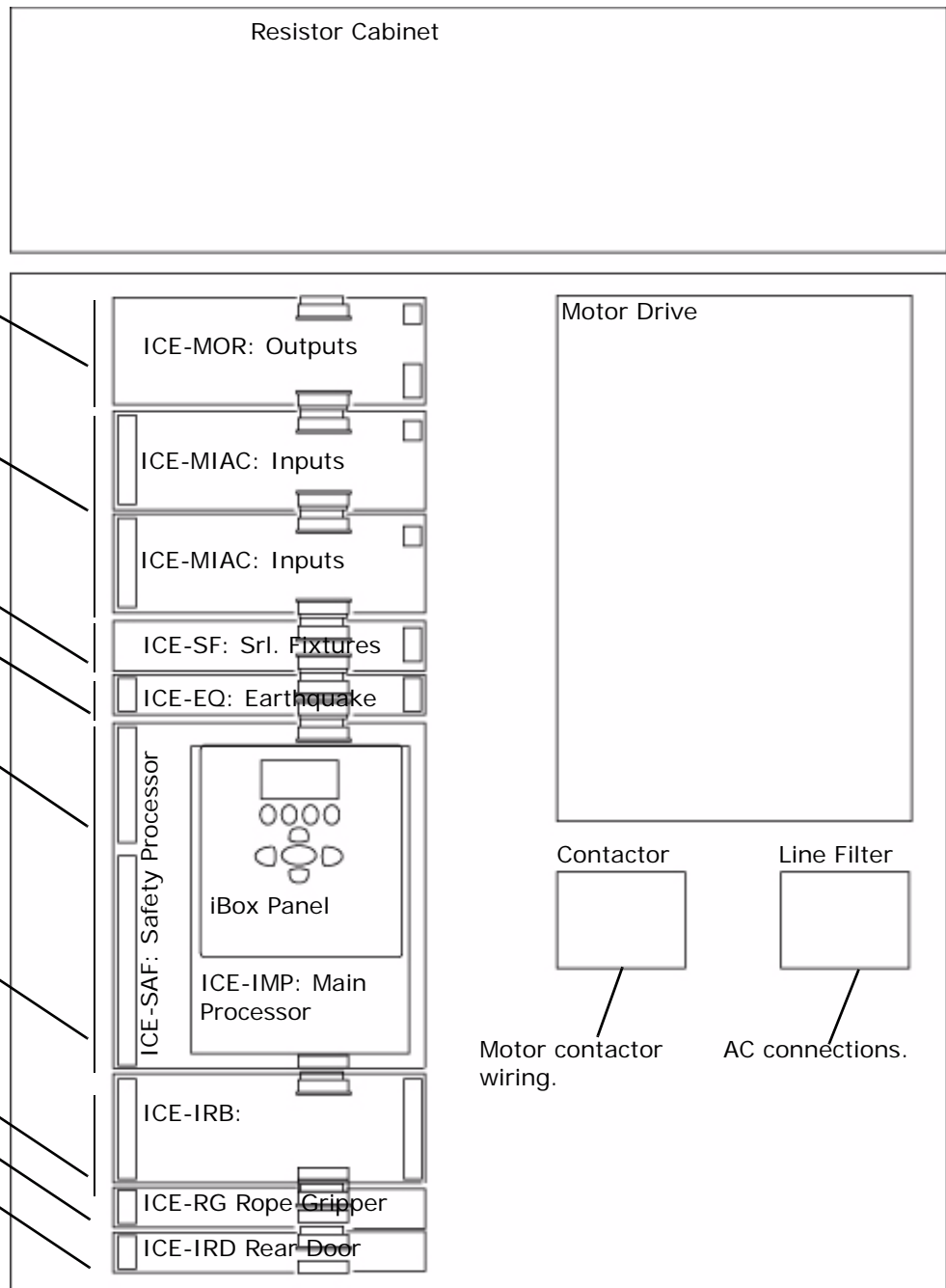
Tachometer, position encoder, velocity encoder, and serial link from cartop processor.

Discrete car connections, limit switches, hoistway, and door system connections.

Safety I/O. Spare I/O. Common, 120VAC, and 110VDC buses.

Emergency Brake connection

Rear door processing



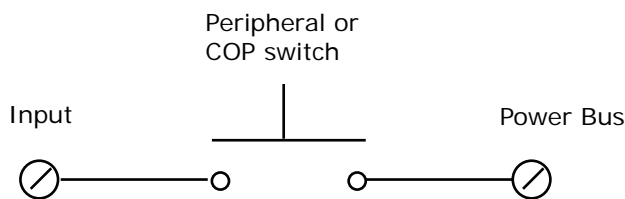
Peripheral Inputs and Outputs

In every installation, there are different requirements for accepting inputs from or providing outputs to various kinds of peripheral equipment. The i product line handles this generic need using ICE-MIAC boards for inputs and ICE-MOR boards for outputs.

Typically an installation will have at least one MIAC and one MOR board in the controller cabinet to handle requirements local to the machine room and at least one MIAC and one MOR board in the cartop interconnect box (iLink) to handle requirements local to the elevator car.

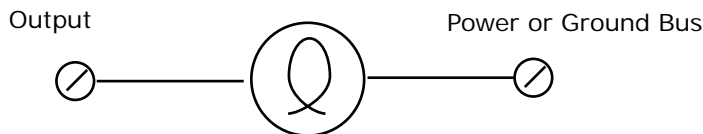
Inputs Refer to your job prints (drawings -2 — nn or -CT) to see exactly how your peripheral inputs are configured. Typical usages include car call buttons, card reader inputs, fire return switches, smoke sensors, etc. To complete an input, the installer wires a switch or contact closure provided by the peripheral equipment between a power bus (120 VAC) and one of the ICE-MIAC board input connections. Exact requirements are collected during the job survey and documented in the job prints. The illustration below shows a typical switch wiring example.

Figure 2.2 Typical Peripheral Switch Connection to ICE-MIAC Board



Outputs Refer to your job prints (drawings -2 — nn or -CT) to see exactly how your outputs are configured. Typical usages include in-service lights, emergency power lights, nudging buzzers, floor chimes, car-riding lanterns and chimes, and car call button indicators (lights). To complete an output, the installer wires the lamp, buzzer, etc. between a power bus and one of the ICE-MOR output connections. Exact requirements are collected during the job survey and documented in the job prints. Different blocks of outputs may be connected to different buses. The illustration below shows a typical (lamp driving) output wiring example.

Figure 2.3 Typical Peripheral Lamp Connection to ICE-MOR Board

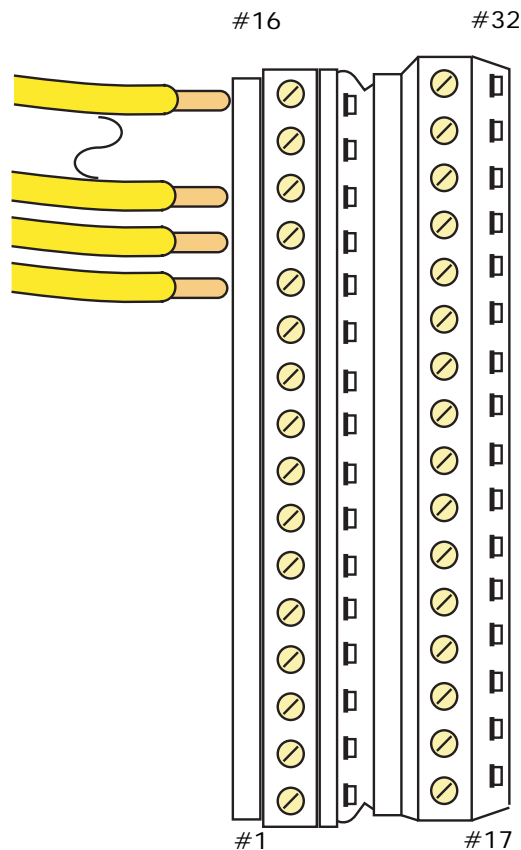


Input/Output Terminals Input/Output assignment may be changed in the iView application but, the job prints specify, and the system is shipped supporting, a logical configuration. For example, the #1 floor button in the car operating panel is connected to the #1 input to the cartop ICE-MIAC board. When the button is pressed, the input signal directs the controller to register a call to floor #1 and the controller activates the #1 output on the cartop ICE-MOR board. The active output completes a circuit and the lamp in the #1 button is lighted so that the passenger knows the call has been registered.

The correlation between input and output is assigned at the factory according to the job survey and the correct wiring is stipulated on the job prints. It is imperative that, if any changes or additions are made, MCE be contacted so that the job prints may be updated to reflect current connections.

Input/Output Wiring Inputs and outputs are wired to pluggable terminals on the cartop or controller ICE-MIAC (inputs) and ICE-MOR (outputs) boards. The connector numbering is the same on input and output boards. Terminal arrangement is shown in the illustration below.

Figure 2.4 ICE-MIAC and ICE-MOR Connector Assignments



Equipment Grounding

For good grounding, quality wiring materials and methods must be used. Grounding must conform to all applicable codes. Proper grounding is essential for system safety and helps to reduce noise-induced problems.

General grounding guidelines include:

- The grounding wire to the equipment cabinet should be the same gauge (diameter) or larger than the primary AC power feeders for the controller and should be as short as possible.
- The grounding wire between equipment cabinets may follow a branching or daisy-chain configuration, but the wire must terminate at the last controller and NOT loop back.
- You must provide a direct, solid ground to the controller and motor. An indirect ground, such as the building structure or a water pipe, may not provide proper grounding and could act as an antenna — radiating RFI noise and interfering with electronic equipment in the building.
- The conduit containing the AC power feeders must not be used for grounding.

Figure 2.5 Controller Cabinet Ground Wiring

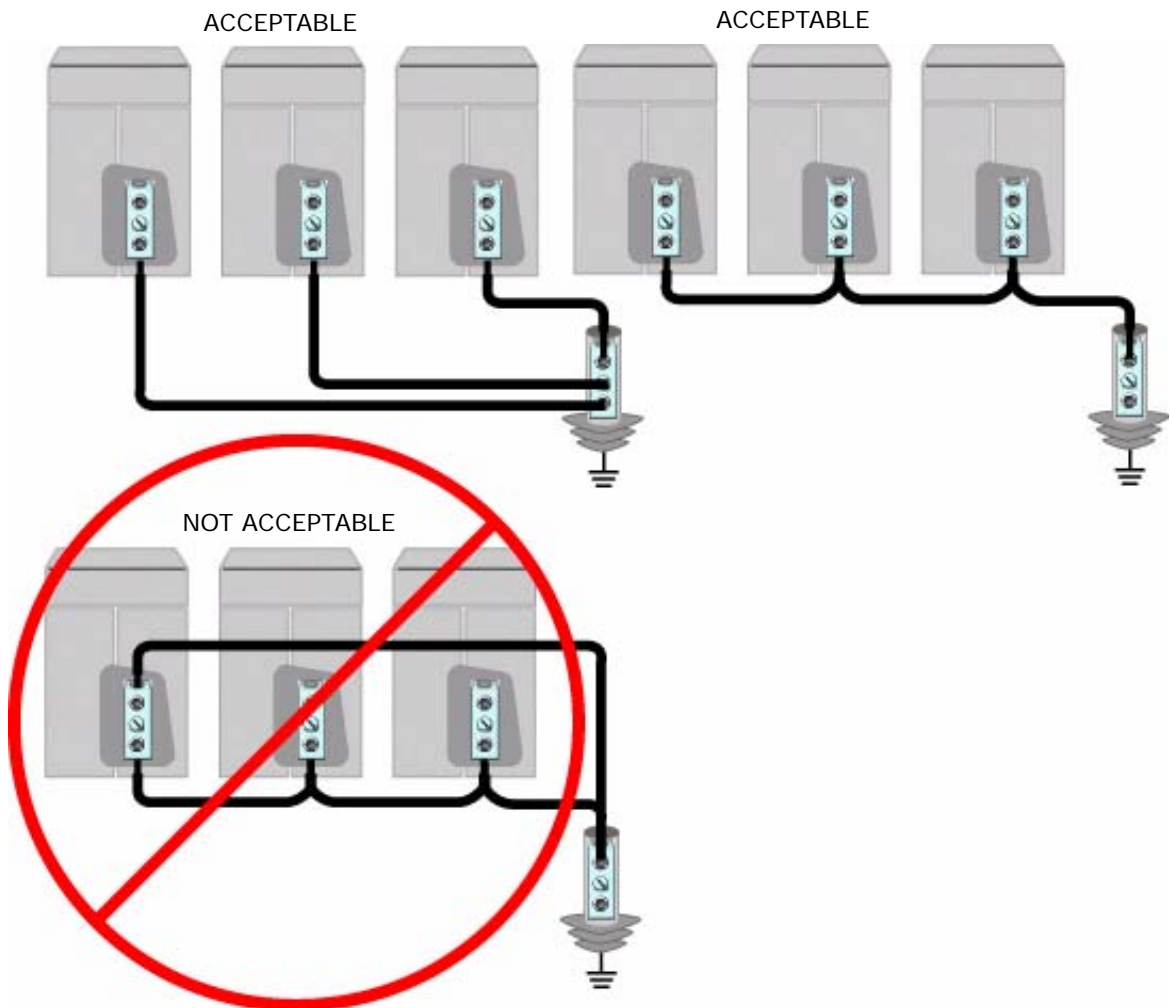
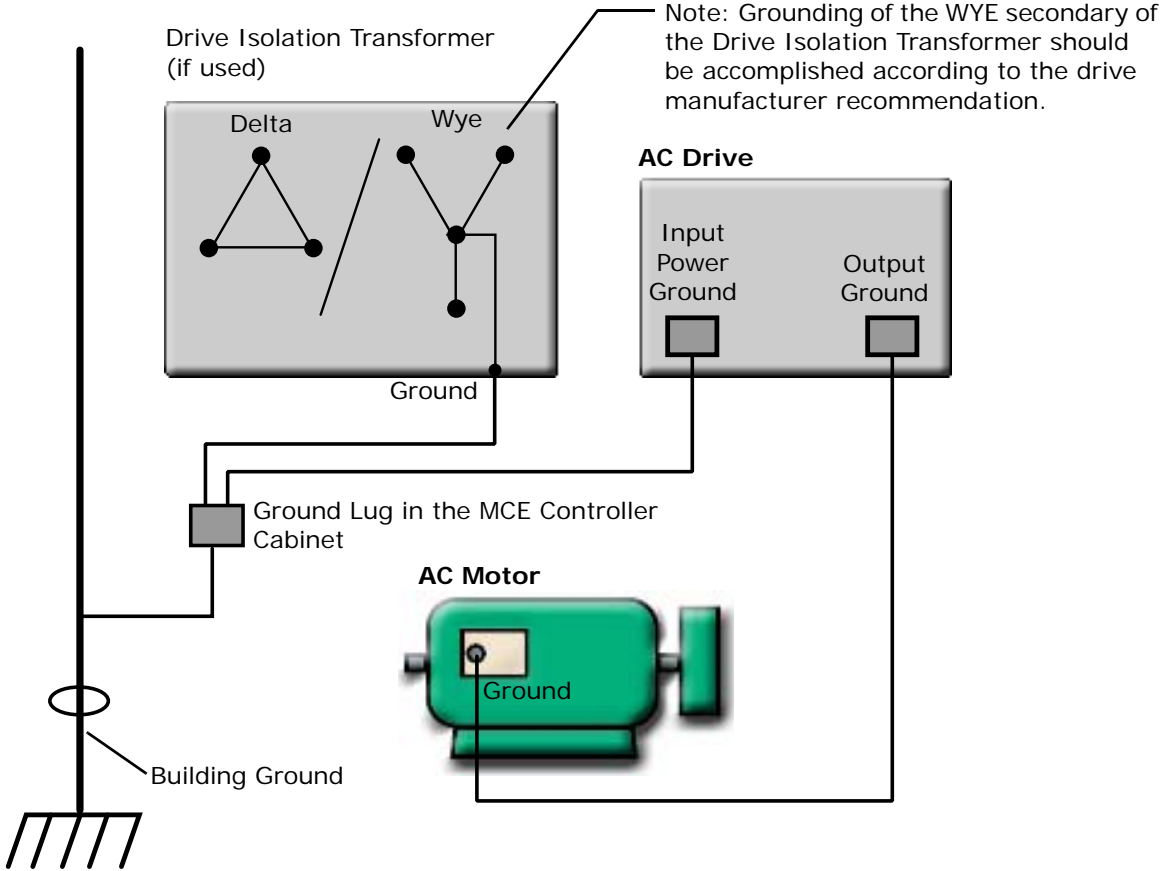


Figure 2.6 Isolation Transformer, Drive, and AC Motor Ground Wiring



Note

The grounding instructions provided in the job prints are specific to your job and are the controlling document if any question arises.

Check for Shorts to Ground

Check for shorts to ground before powering up the system. **Power must be OFF at the main disconnect.** If any shorts to ground are discovered, they must be corrected before proceeding. A short to ground is defined as having a resistance of less than 20 ohms between the #1 (Common) bus and the terminal being tested.



Danger

Be certain that power is OFF at the main disconnect before proceeding.



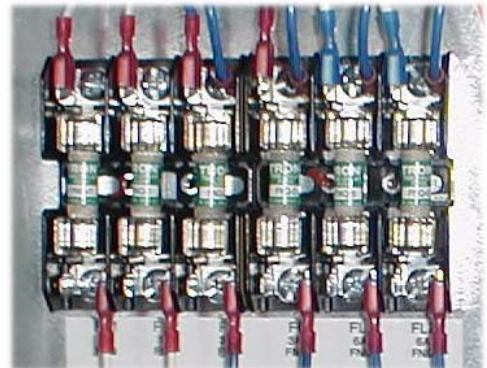
Caution

Typically, the iLink cartop box has not been installed at this point. If the cartop box has been installed **and connected**, it **MUST** be disconnected before checking for shorts in the controller cabinet. This is easily done by simply unplugging all field-wired connectors in the cartop box before checking for shorts to ground.

1. Using a standard screwdriver, temporarily disengage all fuses at the top of the iPower box by turning them counterclockwise until they pop up. **Don't place a cap on a fuse holder without a fuse in it. The cap can get stuck and be hard to remove.**



2. Disengage all fuses at the bottom of the iBox (just below the logo).
3. Release the screws that hold the iPower box closed and open the enclosure. Disengage all the fuses from the fuse block inside (towards the top of) the iPower box by lifting them clear of their sockets at one end.
4. Measure the resistance between the iBox #1 (Common) bus and terminals that have a field connection (DZ down to SP4 on the left side of the iBox).
5. Measure the resistance between the #2 (120VAC) bus terminals and the #1 bus.
6. Measure the resistance between the #3 (110VDC) bus terminals and the #1 bus.
7. Check for shorts to ground on motor power terminals L1, L2, and L3.
8. Check for shorts to ground on brake terminals B1 and B2.
9. If no shorts to ground are discovered, re-engage the fuses. Refer to the job prints for fuse location if necessary.




AC Voltage Verification and Wiring

Instructions in this section describe wiring from commercial power to iControl. Most of the technical information is in the MCE job prints and referenced here as necessary. As shown in the job prints, an isolation transformer may be used to clean up “dirty” commercial power, shift voltage levels, and prevent noise from electrical equipment from being introduced back into the building power system. Isolation transformers are specified in some, but not all, installations.

AC Voltage Verification and Wiring instructions include:

- [Verifying main line power](#) and wiring the controller
- [Initial power up](#)

Note



All conductors entering or leaving the controller cabinet must be in conduit. High voltage, high current conductors, such as power conductors from the fused disconnect or isolation transformer, must be separated from control wires. It is essential that tachometer/velocity encoder control wires be routed through a separate conduit away from high current conductors.

Incoming power to the controller and outgoing power wires to the motor must be in their respective grounded conduit.

Most iControl AC installations use an iField Brake Module to provide selective voltages to precisely control brake picking, brake hold, brake application, and brake timing. In these cases, the job print details for AC input wiring from the transformer may include auxiliary connections specifically for the brake input power connections. Read and follow the job prints carefully.

Verifying Main Line Power and Wiring the Controller

1. Consult the job prints. Verify that AC supply is as specified.



Note

Proper motor branch circuit protection in the form of a fused disconnect switch or circuit breaker must be provided for each elevator according to applicable electrical code. Each disconnect or breaker must be clearly labeled with the elevator number. The electrical contractor must determine the wire size for the main AC power supply and for the wiring from the disconnect or breaker to the drive isolation transformer.

2. If the car is part of a group, the cars in the group must also be wired to provide power to the group cabinet. If this is the case, refer to the Group Supervisor Field Wiring Print in the job prints. Group power is provided by the car controllers as shown in drawing -2. The main AC power supply wiring size must be determined by the electrical contractor.
 - 2a. Check the phase-offset of the individual car ST2-bus lines before connecting them to the Group cabinet. Use a voltmeter set to AC volts to measure between adjacent car ST2-bus terminals in the Group cabinet. The meter must read less than 10VAC. If the reading is higher, reverse the power leads going to the car T1 transformer at L1 and L2 and measure again.



Caution

All 2 bus power from car to Group cabinets must be in phase. **Connecting out-of-phase power WILL cause damage.**

- 2b. A separate conduit or wiring trough must be provided for the System (car-to-car) Ethernet network. Wiring is fully detailed in the job prints. These details must be followed exactly.
 - 2c. If applicable, also wire according to the Group Interconnects to Individual Car Cabinets print. Be sure to ground all cabinets according to instructions.
 - 2d. Refer to the iCentral (Group Supervisor) Field Wiring Print for Group Controller field wiring instructions.
3. If an isolation transformer is used, connect AC supply wiring to the transformer, and transformer outputs to the controller, as shown in the job prints. If required, the prints will detail auxiliary power connections for the brake iField module.
 4. If no isolation transformer is used, connect AC supply wiring to the controller as shown in the job prints.

Initial Controller Power Up

After AC power is connected, you are ready to temporarily power up the controller and check to see that power buses inside the controller cabinet are providing their proper outputs.

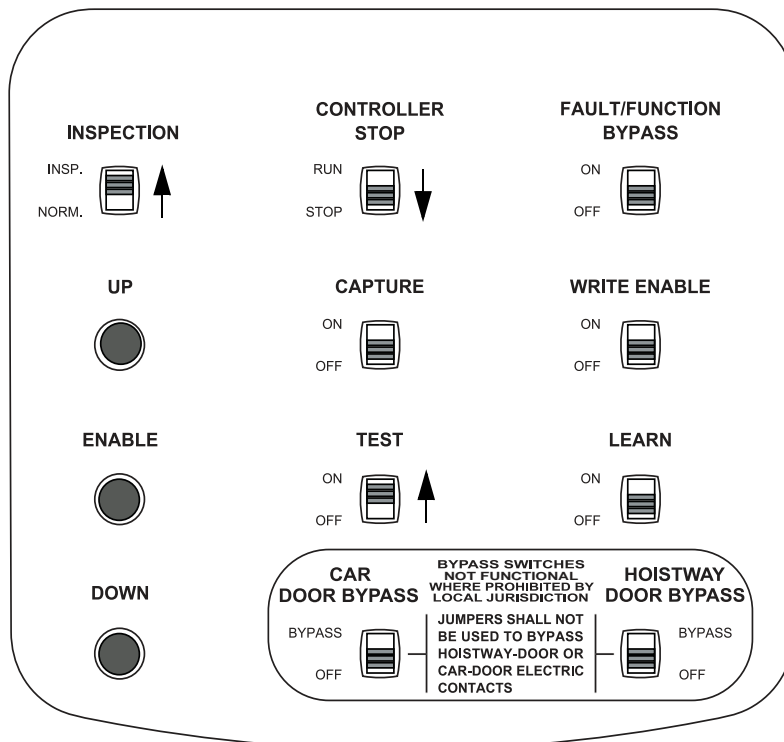


Caution

This procedure assumes that no field wiring has been connected to the controller. If field wiring has been connected, disconnect it before beginning this procedure. Before applying power, physically check all power resistors and other components located in the resistor and controller compartments. Components loosened during shipment may cause damage.

1. On the iBox, verify:
 - Inspection switch UP (Inspection mode selected)
 - Controller Stop Switch DOWN (Stop selected)
 - Test switch ON
 - All other iBox slide switches DOWN (Off)

These switch settings prevent the elevator from moving when the controller is powered up.



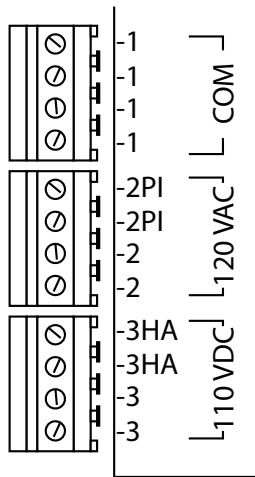
Note

The controller microprocessor board has battery backup for logic retention. An insulator prevents the battery from discharging during shipment. Remove the insulator now if has not already been done.

2. Power up the controller. The system will take about sixty seconds to boot.
3. If the controller fails to power up, refer to the job prints and check supply connections and fuses.

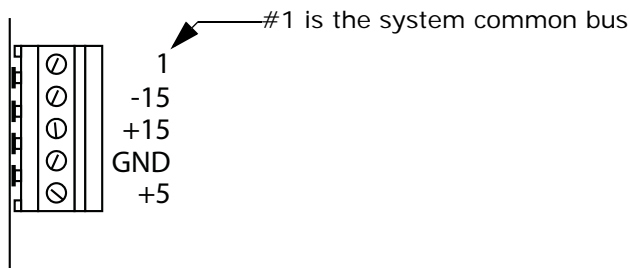
Inside the controller cabinet, 120VAC and 110VDC output buses are presented at the lower left corner of the iBox as shown in the illustration below.

4. Measure from any #2 bus terminal to a Common (#1) terminal and verify 120VAC (+/- 10%).
5. Measure from any #3 bus terminal to a Common (#1) terminal and verify 110VDC (+/- 10%).



Power for PC board circuitry is provided through a 5-position, pluggable connector on the right side of the iBox (near the Computer and Drive Reset buttons) as shown below.

6. Measure from each of the voltage terminals to GND to verify -15VDC, +15VDC, and +5VDC respectively (+/- 2%).



Note

If any bus voltage is missing, check the associated fuse. The fuses are labeled with the bus numbers and are located at the top and bottom of the iBox.

7. Power the controller down (in preparation to continue wiring equipment).

AC Hoist Motor, Brake, and Velocity Encoder

This section contains instructions for:

- Checking the hoist motor for insulation breakdown or short to ground
- Wiring the hoist motor to the controller
- Verifying iField module or low-current [brake resistance and wiring the brake](#)
- Installing the [velocity encoder](#)

Checking the Hoist Motor

If this job reuses existing rotating equipment, the equipment must be checked for insulation breakdown before proceeding.

1. Disconnect all motor and brake wiring.
2. Perform an insulation test between these wires and the frame of the related equipment using a Megohm meter to subject the insulation to the same high voltages that would be present during elevator operation.
3. A minimum insulation resistance of 100k Ohms is required.
4. Correct any insulation problems before proceeding with installation. Insulation problems may indicate a serious problem in the equipment.

Wiring the Hoist Motor to the Controller

Incoming power to the controller and outgoing power wires to the motor must be in their respective grounded conduit.

It is very important that AC motor wires be kept separate from control wires both inside and outside the controller cabinet. The encoder or tachometer wiring must use a separate grounded conduit. Use a shielded power cable between the motor drive and the AC Motor stator connections to reduce RFI/EMI noise (Siemens Proflex - EMV or equivalent). The shield must be terminated to earth ground at both ends. Keep the AC power wiring separate from the control wires.

1. Refer to drawing -D1 in the job prints. This drawing shows the AC drive and connections to rotating equipment.
2. Make connections as shown in the job prints. Be certain to follow any schematic notes regarding wire sizes and any specific motor wiring connections.

Verifying Brake Current Resistance

High current brake systems use a brake (iField) module to control the brake.

1. With the brake leads disconnected from the controller, measure resistance through the brake coil.
2. Inside the controller cabinet, locate the screws, one at the top and one at the bottom right corner of the iPower box (the enclosure the iBox is mounted to). Turn the screws counter-clockwise to their stops and open the enclosure (it is hinged on the left).
3. Refer to job print drawing D2. Toward the right-top of the enclosure, locate the large ceramic resistor labeled RB.
4. Check the resistance across RB. As an initial working value, RB resistance should be about three times (3 X) the resistance measured across the brake coil.

Note

During adjustment, the resistance across RB may be further adjusted to achieve smooth setting of the brake. Too little resistance causes the brake to remain picked for too long. Refer to your job prints for instructions.

5. If necessary, adjust RB resistance by loosening and sliding the center-tap up or down. When the resistance is correct, retighten the center tap.



RB is in this area
Additional resistors
may be used

The controller i Power
box release screws
are in the top and
bottom right corners
of the enclosure. Door
must remain closed
during operation.



RB is a large,
ceramic resistor
with a center tap.

Loosen and slide
the center-tap
ring to change
resistance.

Wiring the Brake

1. Refer to job print drawing D3. Connect brake wires to terminals B1 and B2 located just below the iPower box.



 **Note**

Brake wires must not be routed in the same conduit with AC motor wires or velocity encoder wires.

Velocity Encoder Installation and Wiring

The velocity encoder reports hoist motor speed to the controller. The encoder must be mounted and wired according to the drawings. When installed, the encoder must be electrically isolated from the motor or any other ground. (Resistance between the encoder casing and the motor or other ground should be “infinite.”)

Do not place the encoder or its wiring close to a magnetic field (the motor or brake coils). Magnetic fields can induce AC into the encoder signal. This can cause the Drive to miscount, producing erratic control at lower speeds.

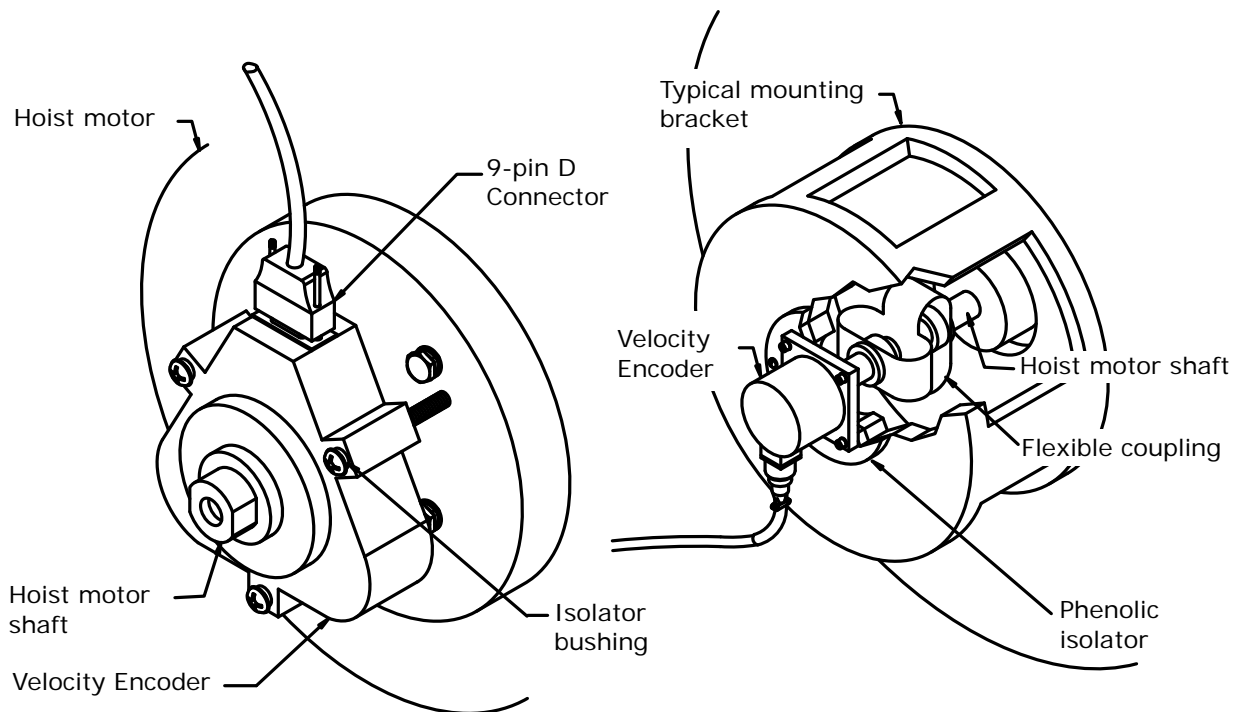


The encoder wiring must use a separate grounded conduit. Inside the controller cabinet, if control wires must cross power wires, they must cross at right angles to reduce the possibility of interference. Some cables, like the EnDat encoder cable, require a one inch or larger conduit due to the size of the connector.

Encoder Mounting

The following illustration shows two typical encoder installations.

Figure 2.7 Typical Encoder Installations



It is very important that the encoder does not slip, wobble, bounce, or vibrate due to poor installation of the shaft extension, coupling, or encoder mounting. It is also important that the encoder housing be electrically insulated from the motor, machine or other grounds if the encoder is manufactured by BEI. An insulated encoder mount has been furnished with the BEI encoder. However, this type of mounting may not be practical for all applications, therefore, the best method for mounting the encoder and coupling it to the motor must be determined at the job site.

Encoder Isolation

The encoder housing must be electrically isolated from the machine (ground). To check this:

1. Measure the resistance between the encoder case and the frame of the motor.

The measured value must be “infinite” for complete isolation.

Encoder Wiring

A shielded cable with an appropriate connector at the encoder end is provided. [Please refer to “Encoder Cables” on page 2-26](#). The controller end of the cable exposes trimmed and tinned individual conductors. The encoder cable must be routed into the controller cabinet in a separate conduit.

1. Connect the cable to the encoder using the cable/connector provided.
2. Route the cable through a separate conduit to the controller cabinet. Inside the controller cabinet, if the encoder wires must cross power wires, they must cross at right angles to reduce the possibility of interference.
3. Connect the controller end of the cable to the TORQMAX F5 drive as shown in the job prints.

2



Caution

Do not coil excess encoder cable near high voltage components — noise may be induced. If the cable must be shortened, trim it at the controller end. Do not cut and re-splice in the middle of the cable or shorten at the encoder end (see also caution below).



Caution

The cable supplied with the Heidenhain ENC1313 EnDat encoder must not be altered, cut or shortened. Therefore, a 1.5 inch conduit is required to accommodate the cable connector.



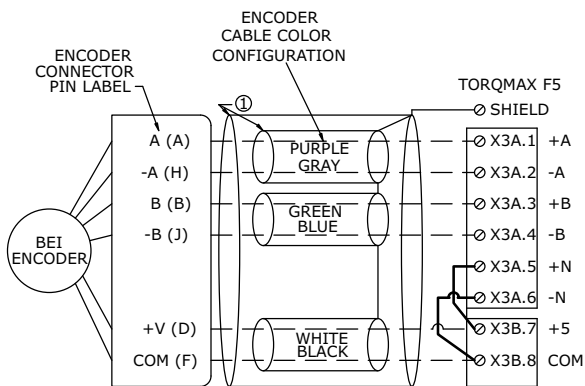
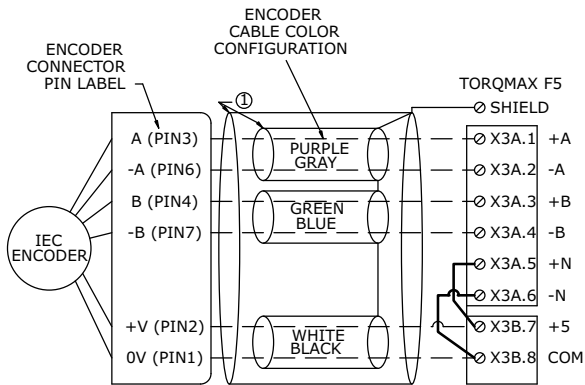
Caution

Permanent magnet (PM) AC Gearless Machines must be synchronized with the AC Drive. Please refer to *PM Synchronous Motors > Motor Data* and *Loading motor data from encoder* in the *Initial Start Up* section of the TORQMAX F5 drive manual.

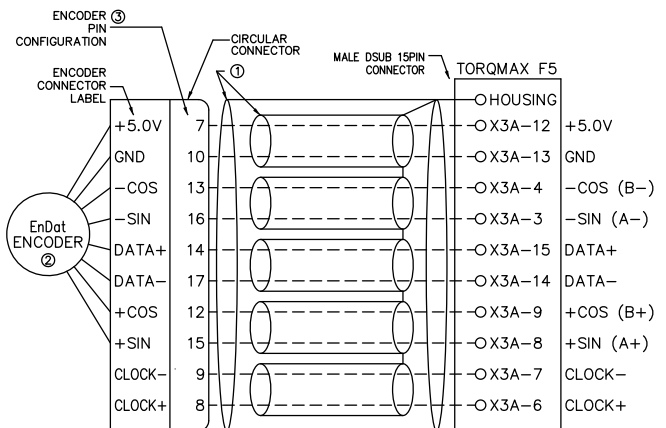
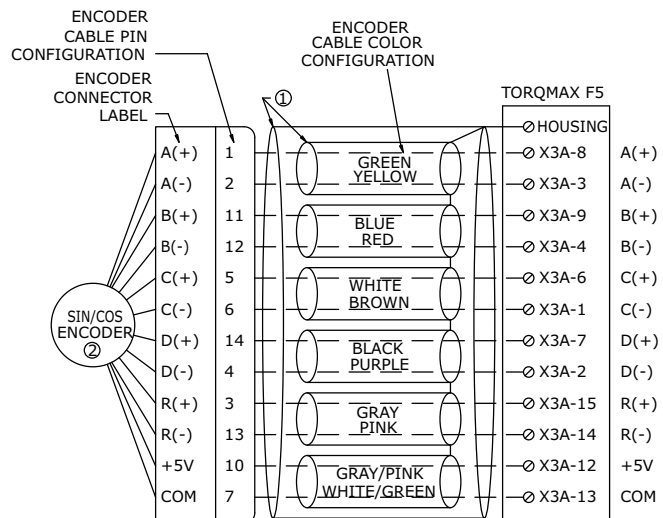
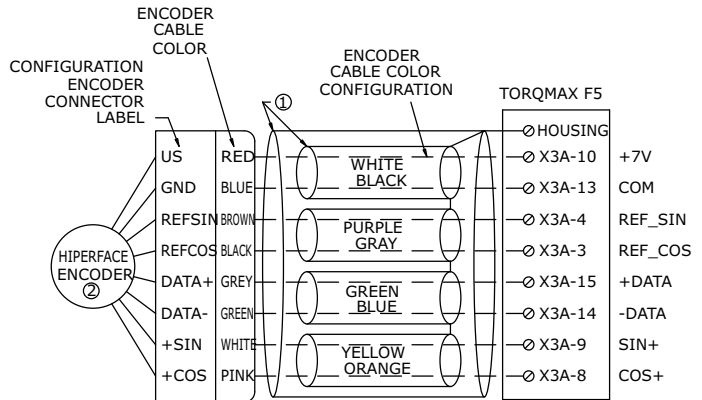
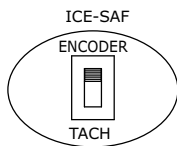
Encoder Cables The following illustration shows typical encoder wiring. These connections are shown for illustration purposes only. Follow the job print instructions for your specific encoder connections — they may be different than those shown here.

Induction Machine

PM Machine



- ① NO CONNECTION FOR SHIELD AT THIS END
- ② ENCODER IS MOUNTED ON THE MOTOR SHAFT



- ① NO CONNECTION FOR SHIELD AT THIS END
- ② ENCODER IS MOUNTED ON THE MOTOR SHAFT
- ③ ENCODER CABLE MUST BE PULLED THROUGH METALLIC CONDUIT, IT IS NECESSARY TO OVER SIZE THE CONDUIT (1 INCH OR LARGER). DO NOT REMOVE CONNECTOR.

Basic Safety String and Associated Wiring

This section contains wiring instructions for basic safety string switches (in Construction Mode, before the iLink cartop interconnect is installed). A safety string is essentially a number of normally-closed switches connected in series such that, should any one of the switches open, power to the motor and brake will immediately drop to stop the car. Depending upon your installation, you may not have the exact switches described here. The job prints for your installation accurately show the safety string elements at your site. In any event, the elevator must not be run until the safety string is connected. Safety string wiring includes:

- Emergency Stop switch
- Hoistway safety switches
- Cartop safety CTS Relay temporary bypass (for Construction Mode use only)

The location and number of safety switches varies from job to job. MCE job prints indicate exact job wiring as determined during the job survey. [Please refer to “Safety Bypass Jumper and Fuses” on page 7-13](#) for bypass related information.

Cartop Safety Switches

Depending upon the job, cartop safety switches may include:

- Safety Clamp Switch
- Emergency Exit Contact
- Emergency Stop Switch
- CTS Relay (iLink)

The wiring instructions for these switches are on the job prints.

1. Refer to the job prints.
2. Wire the cartop safety switches as shown.

Note

The Cartop Safety Relay is located in the cartop interconnect box. If the cartop box is not yet installed, it will need to be temporarily bypassed to get the car operating in construction mode. For now, using the switches and terminals available to you, wire as much of the string as you are able.

Hoistway Safety Switches

Depending upon the job, hoistway safety switches may include:

- Final Limit Switches
- Buffer Switches
- Pit Door Switch
- Pit Stop Switch
- Governor Switch

The wiring instructions for these switches are on the job prints.

1. Refer to the job prints.
2. Wire the hoistway safety string switches as shown.

Temporary CTS Relay Bypass

Because the iLink cartop interconnect box which contains the Cartop Safety (CTS) Relay is not yet installed, it is necessary to bypass the CTS relay temporarily (for Construction Mode only). (If you in fact are installing the iLink cartop box already, please refer to the iLink instructions in Section 3 of this guide.)

1. Refer to the job prints.
2. Connect the safety string in series between the iBox SAFH and SAFC terminals.
3. You must provide an Emergency Stop switch in series between SAFH and SAFC.



Danger

Make sure the Emergency Stop switch is wired in series between SAFH and SAFC to allow emergency stopping while working on the cartop.

Access Locks and Contacts

Door switches include:

- Car door: GS (Gate Switch).
- Hall doors: DLMS (Door Lock Main String), DLAT (Door Lock Access Top), DCAT (Door Contact Access Top), DLAB (Door Lock Access Bottom), DCAB (Door Contact Access Bottom).

1. Refer to the job prints.
2. Connect the switches for front and rear (if present) doors as shown.

Rope Gripper Wiring

An “emergency brake” may be connected between iControl terminals RG1 and RG2 to stop unexpected car motion. A rope gripper is used to apply braking pressure to the hoist ropes. After it is triggered, press the iBox Fault Reset button or the Rope Gripper board reset button to reset the rope gripper.

1. Refer to the job prints (MRW- machine room wiring sheets).
2. Connect the rope gripper to iControl RG1, RG2, RG5, and RG7 terminals as shown.

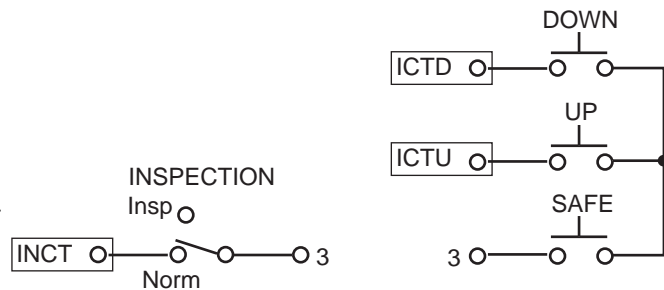
Temporary Rope Gripper Bypass

If a Rope Gripper will be installed later, you may temporarily bypass the input by installing a jumper between RG5 and RG7.

Temporary Cartop Inspection Wiring

Four cartop switches control car motion: An Inspection Enable switch, a Safe switch, an Up switch, and a Down switch.

1. Refer to job print drawing -CW, Cartop Inspection Station.
2. Connect the (Normally Closed) Cartop Inspection Enable switch between the #3 bus and the iControl INCT terminal as shown. (This is the switch used to put the controller on cartop inspection. INCT is active low.)
3. Connect a Safe push button switch between the #3 bus and the direction push buttons.
4. Connect a Down push button switch between the Safe switch and the iControl ICTD terminal as shown (active high).
5. Connect an Up push button switch between the Safe switch and the iControl ICTU terminal as shown (active high).



2

Applying Power

1. Set the iBox Inspection switch to the Inspection position.
2. Set the Controller Stop switch to the Stop position.
3. Set the Test switch to On.
4. Turn on power at the main disconnect.
5. Watch the front panel displays of the iBox, the controller will take about 60 seconds to initialize.
6. Check the iBox Computer, Safety A, and Safety B status LEDs. The LEDs should be lighted solid green.

Setting Initial Operating Parameters

Once all Construction mode connections are complete, certain iControl parameters must be set or verified. These settings must be accomplished using a computer running iView software.

The iBox may be accessed using iView or the iBox keypad. However, both are not allowed to make changes at the same time. By default, the iBox keypad has control but once an iView user has acquired write privileges (*Privilege/Acquire*) the keypad is prevented from making changes until the iView user relinquishes the write privilege.

Connecting the iView PC

Please refer to [“Installing iView” on page 8-3](#) if you have not yet installed iView on your PC.

There are two ways to connect the iBox to a PC:

- **Direct Connection:** Connect the PC directly to the iBox through the iBox 3=PC port. [Please refer to “Direct Connections” on page 2-35.](#)
- **Peripheral LAN Connection:** Connect the PC to the LAN hub supporting one or more iBox controllers (iBox #1 port). If you are connecting to multiple iControls, please refer to the *iCue User Guide* that accompanied the group controller for LAN instructions.

The illustration and table on the following pages provide examples of the factory default Ethernet addresses used by iControl and iCue groups.



Note

About LANs: LAN stands for Local Area Network. A LAN is basically several computers (or smart equipment with a computer inside — like the iBox) all connected to a common point (the hub) so they can communicate with each other. In order for a message from one computer to reach the computer (or iControl/iBox) it wants to talk to, all the computers connected to the LAN have to have their own address. The address is called a TCP/IP number. [Please refer to “System and LAN Ethernet” on page 11-15](#) for more detail.



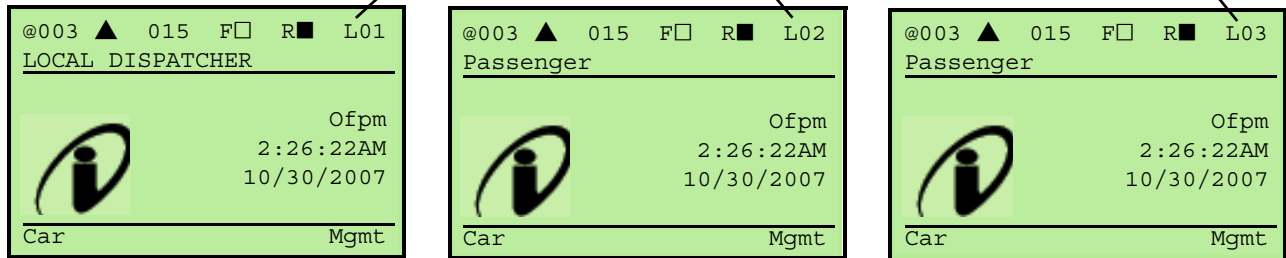
Caution

Before connecting the “System” ethernet cable to the iBox:

1. Verify that the Car ID, in the upper right corner of the iBox display, is correct. Press the iBox “Computer Reset” button and when the display returns, verify that Car ID is still correct. The Car identifier is set on the iView > Controller > Configuration > General tab (see “Configuration - General” on page 9-95).
2. Verify that no other iBox in this group of controllers has the same Car ID (see Figure 2.8).
3. Check the “Alternate Dispatcher” settings on the iView > System > System Configuration > Building tab (see “System Configuration tab” on page 10-6). Verify that the “Auto-select Preference Order” settings are identical on every car in this group of controllers (see Figure 2.8).

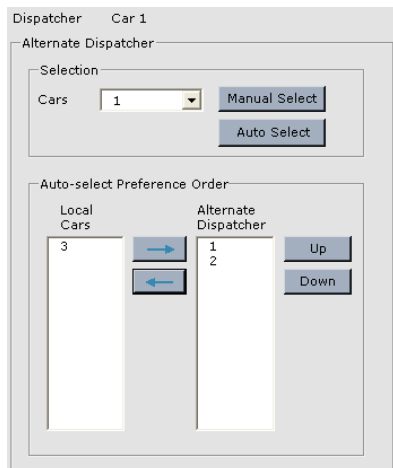
Figure 2.8 Check before connecting the “System” ethernet cable to the iBox

Check for correct Car ID. Verify that no two Car IDs in the group are the same.

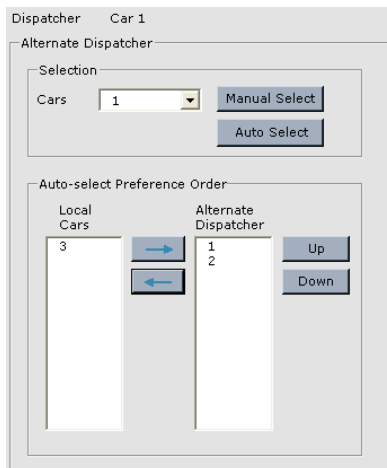


On the iView > System > System Configuration > Building tab, verify that the Alternate Dispatcher “Auto-select Preference Order” settings are identical for all cars in the group.

Car 01 System Configuration



Car 02 System Configuration



Car 03 System Configuration

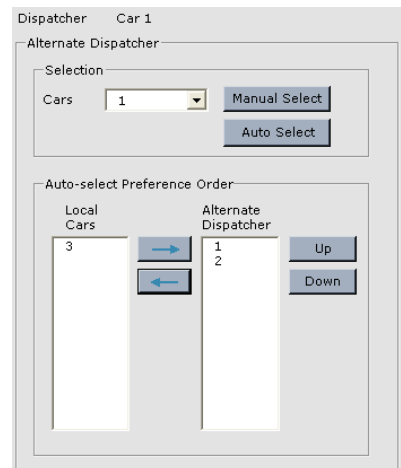
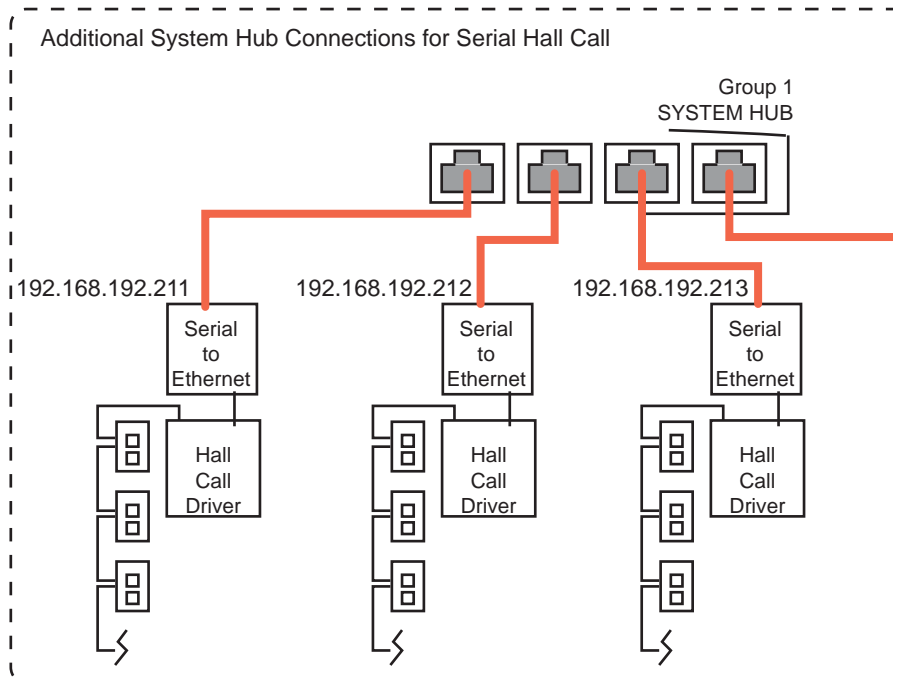
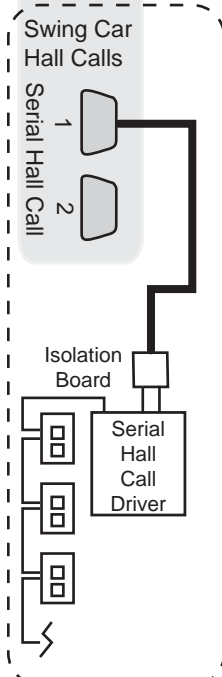
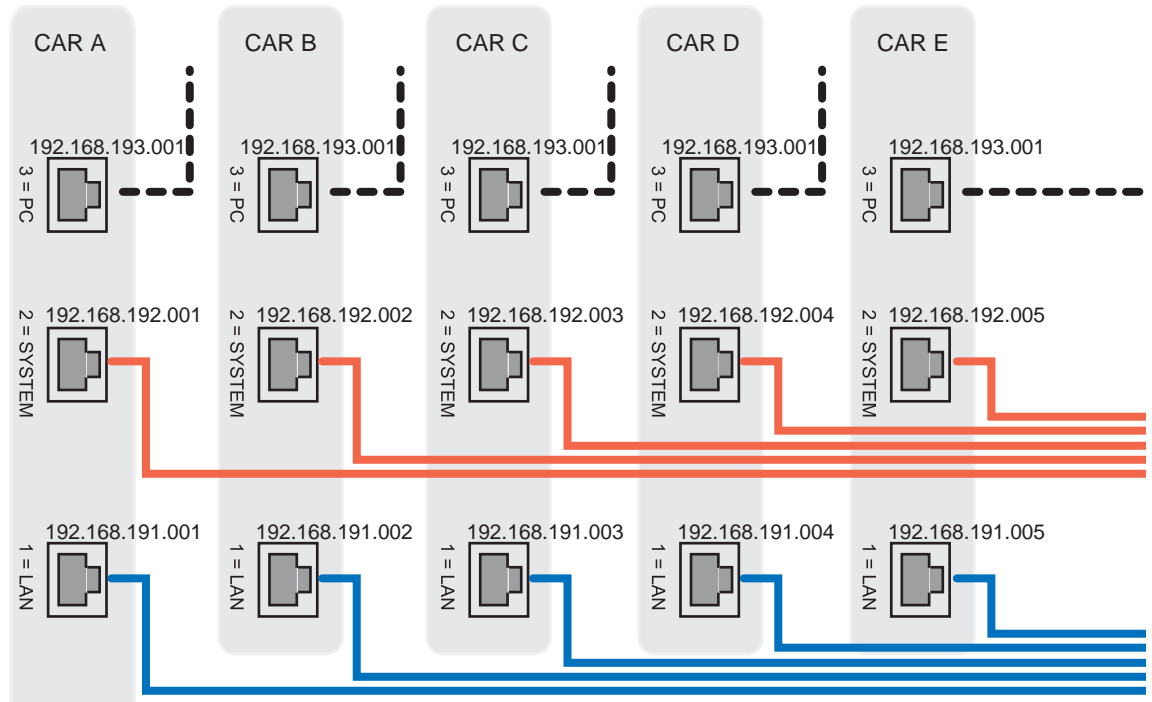


Figure 2.9 Controller and Group Ethernet Examples

GROUP 1 ETHERNET ADDRESS EXAMPLES



Setting Initial Operating Parameters

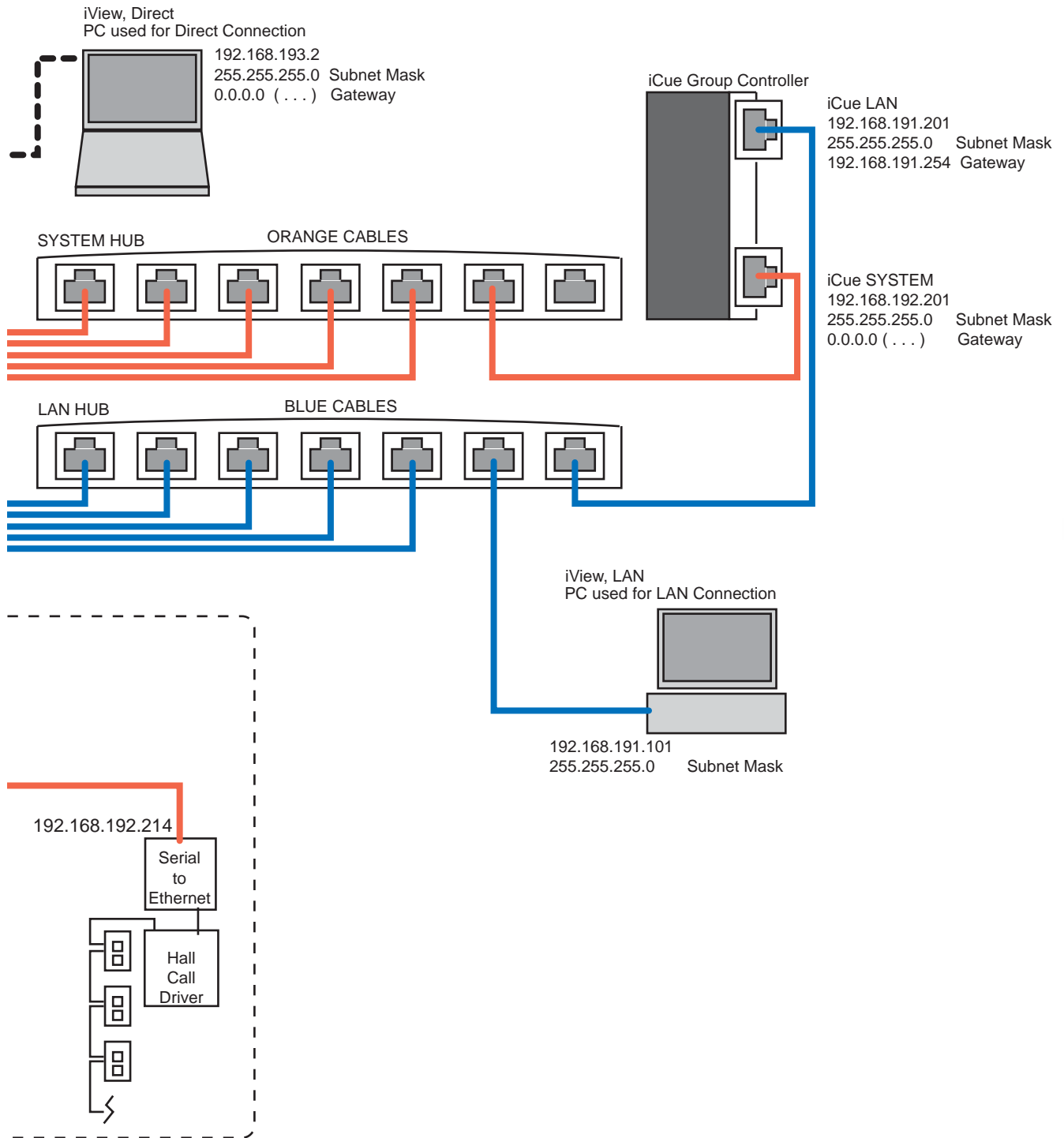
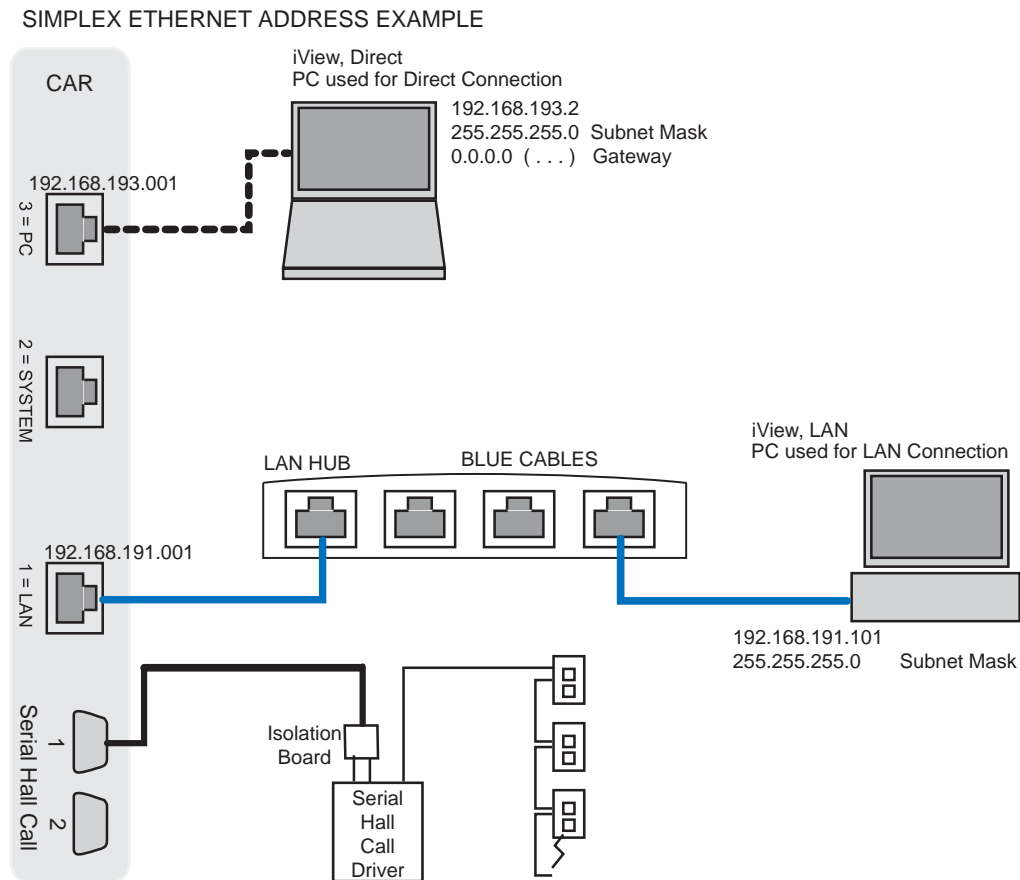


Figure 2.10 Simplex Controller Ethernet Example



The table below lists the factory default addresses for elevator and group controllers. The #3 iBox port (PC=Direct) is set to 192.168.193.001 and should not be changed. Do not use leading zeros when setting IP Addresses on a PC (i.e., .021 is entered as .21). (When entering IP Addresses on the iBox keypad, you must use leading zeros.)

Table 2.3 System, LAN, & 3=PC TCP/IP Addresses

Hub	Group	Group IP Primary & Backup	Car ID	Car IP	System/Serial Hall Call Bus 1 - 4	Free
System	all	192.168.192.201-202	1-20	192.168.192.001-020	192.168.192.211-214	192.168.192.101-120
LAN	1	192.168.191.201-202	NA	192.168.191.001-020		192.168.191.101-200
LAN	2	192.168.191.203-204	NA	192.168.191.021-040		192.168.191.101-200
LAN	3	192.168.191.205-206	NA	192.168.191.041-060		192.168.191.101-200
LAN	4	192.168.191.207-208	NA	192.168.191.061-080		192.168.191.101-200
LAN	5	192.168.191.209-210	NA	192.168.191.081-100		192.168.191.101-200
Port #3 = PC (iBox ONLY), NO HUB				192.168.193.001		

* 192.168.191.101 is typically used for the iView PC.

The default Subnet Mask for all ports is 255.255.255.000.

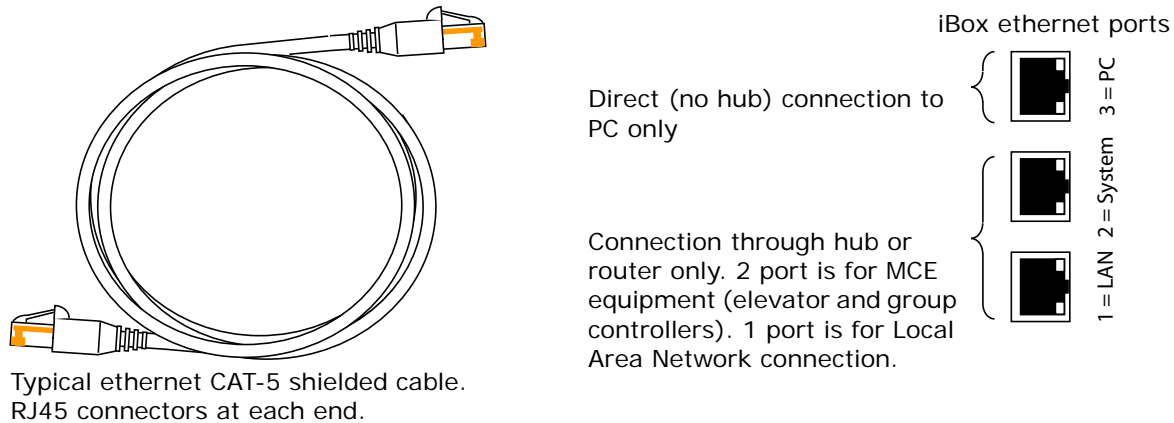
Please refer to “Setting iBox Ethernet Port Addresses” on page 7-9 for instructions on checking IP settings on the iBox.

Direct Connections

Unless a Local Area Network (Ethernet) hub has already been installed, you will find it easiest to connect a PC to the iBox using the #3 PC port on the iBox (direct connection). To make a direct connection:

1. Connect the iView PC to the controller 3=PC port using only a standard Ethernet cable. **(Do not connect the #3 port through a hub or router.)**

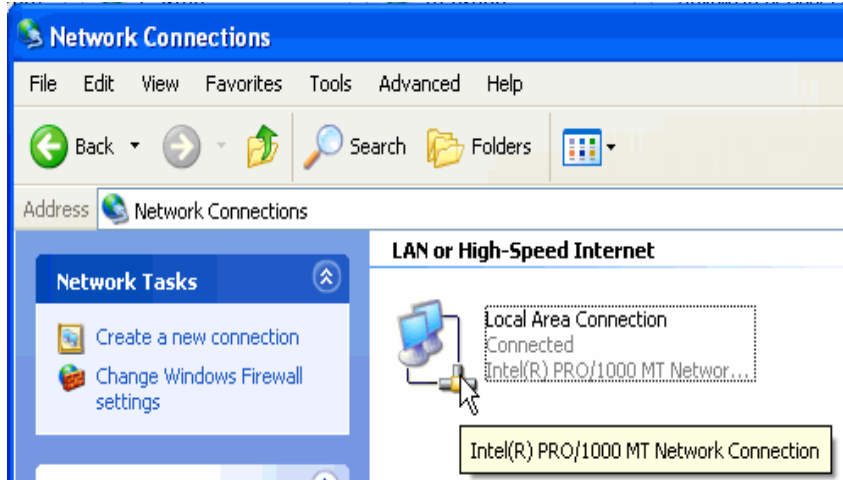
Figure 2.11 Ethernet Cable and iBox Ethernet Ports



Note

The iBox #3 Ethernet port address, gateway, and mask are set to default values by MCE. If you have used your PC to connect to other iBoxes, you probably only need to connect the cable, launch iView, and select the connection with the appropriate IP information and use that to connect. When creating direct connections in the iView connections folder, it is a good practice to name them clearly so they are easy to distinguish (i.e., "CarA Direct"). The instructions here are intended to help a first-time user make a direct Ethernet connection between a PC and the iBox.

2. Start the PC.
3. From the Windows XP *Start* menu, click *Control Panel*.
4. Double-click *Network and Internet Connections* to open the Network and Internet Connections dialog.
5. Double click *Network Connections* to open the Network Connections dialog.
6. Double-click the *Local Area Connection* icon to open the Local Area Connection Status dialog.

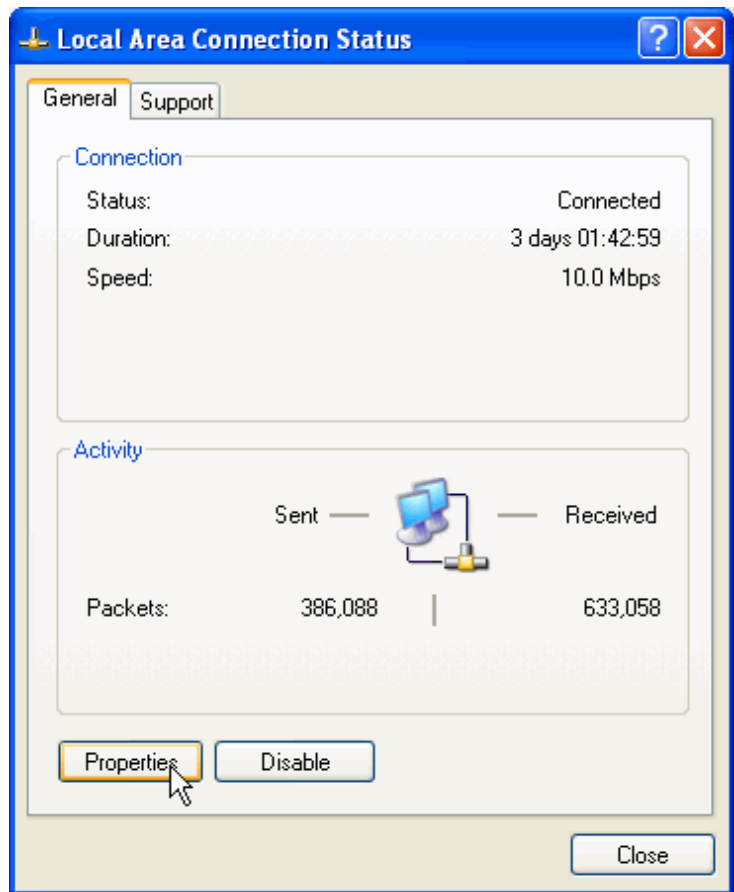


7. Click *Properties* to open the Local Area Connection Properties dialog.

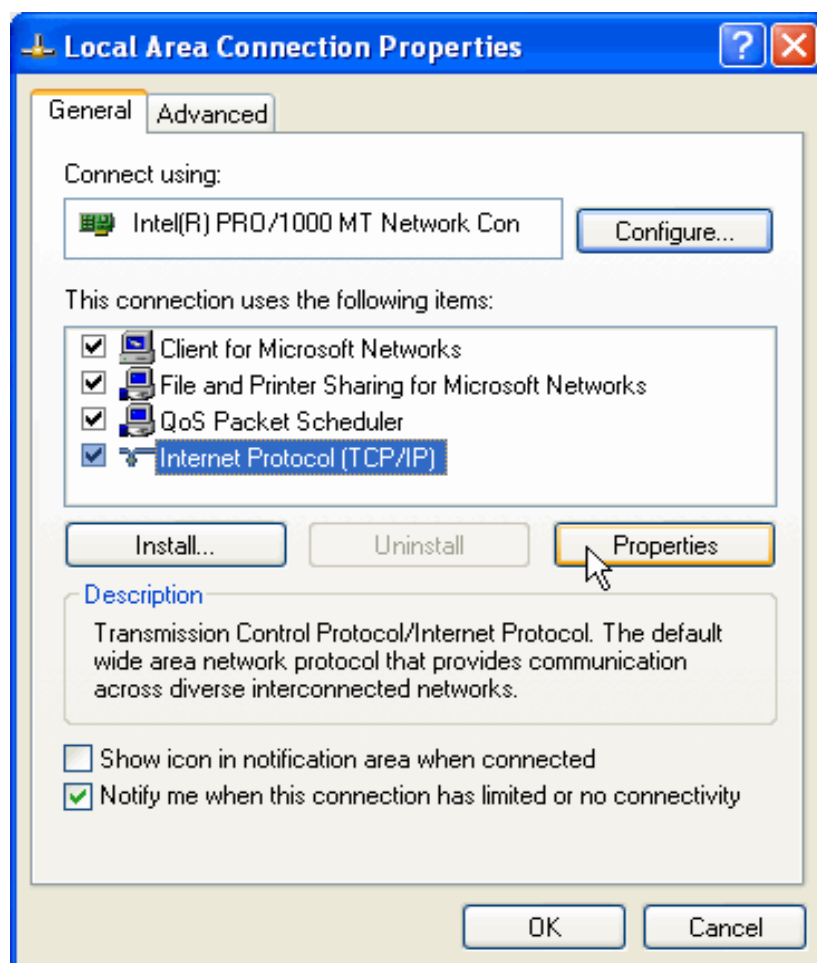


Note

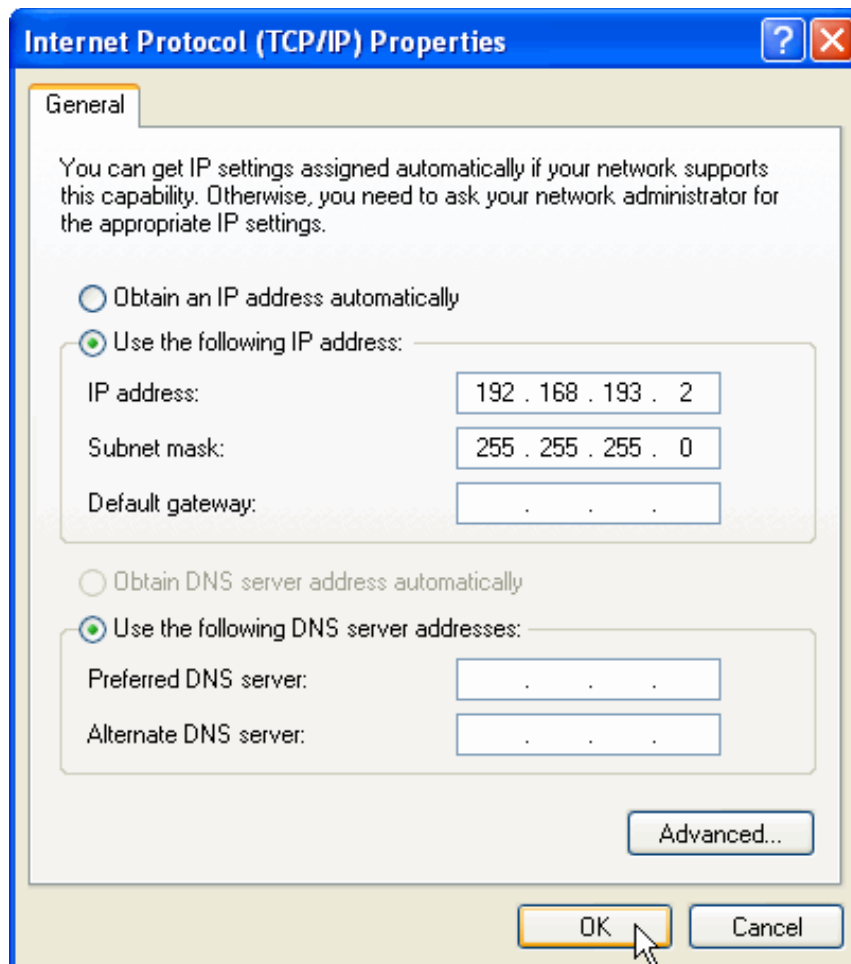
Sample screens are Windows XP™ operating system.



8. In the Local Area Connection Properties dialog, select *Internet Protocol (TCP/IP)*.
9. Click *Properties* to open the Internet Protocol (TCP/IP) Properties dialog.



10. Set the IP Address to match the iBox EXCEPT FOR the last set of numbers. The #3 iBox port is defaulted to 192.168.193.1. Typically, you can set your PC's IP address to 192.168.193.2.



11. Set the Subnet Mask to 255.255.255.0.
12. Click OK and follow any instructions to save the changes you made.

**Note**

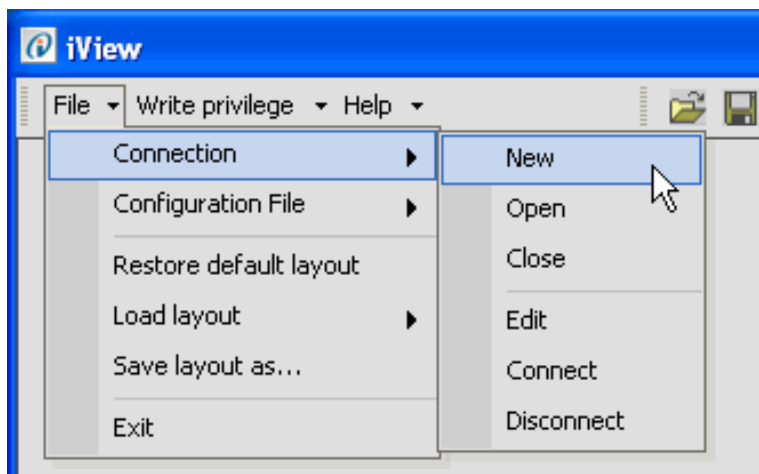
Sample screens are Windows XP™ operating system.

**Note**

It is important that a PC have only one IP address assigned. Click the *Advanced* button and verify that the PC is configured for only a single IP address (192.168.193.2). If there is more than one IP address, highlight the additional IP address and then click *Remove*.

Creating a Direct Connection in iView Once you have set your computer TCP/IP as described previously, you need to create a connection in iView.

1. Double-click on the iView icon on your computer screen to launch iView.
2. Click *File* on the menu bar.
3. Select *Connection* and click *New* to open the Connection dialog.

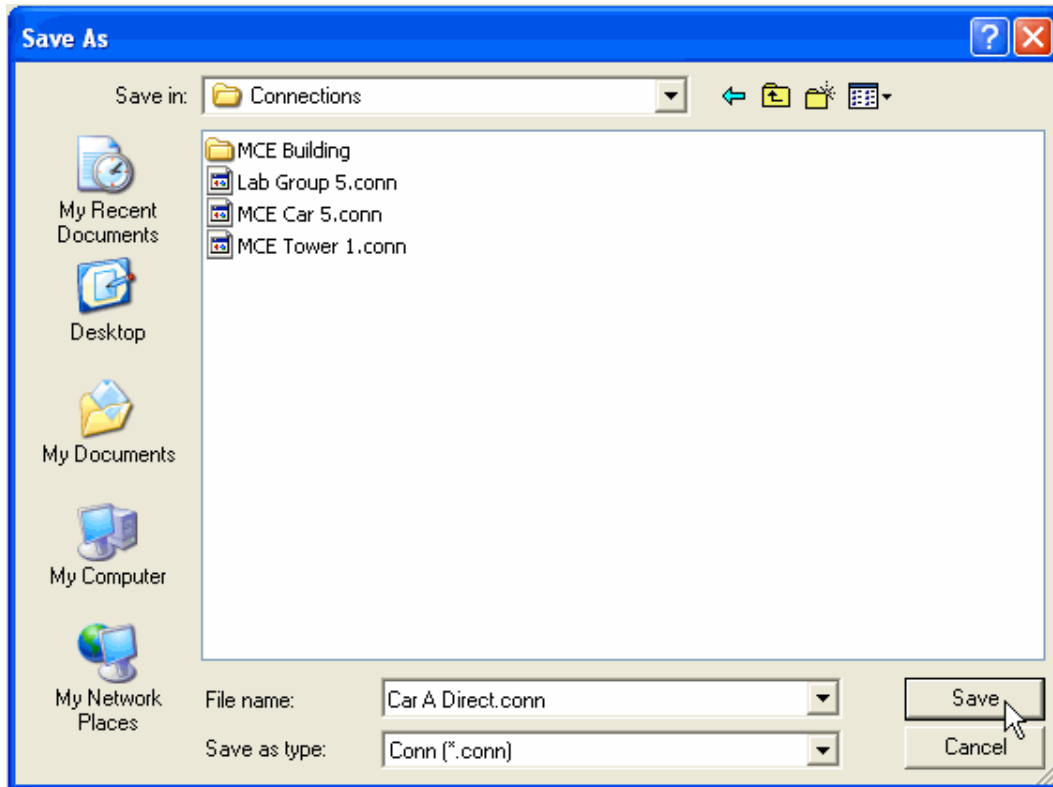


4. Type in a name for the connection.
5. Enter the direct connection IP Address for the iBox (192.168.193.1).
6. Select *Controller/Simplex*. If creating a connection to an iCue PC, select *Group* and *PC*.
7. Click *OK*. The Save As dialog opens.



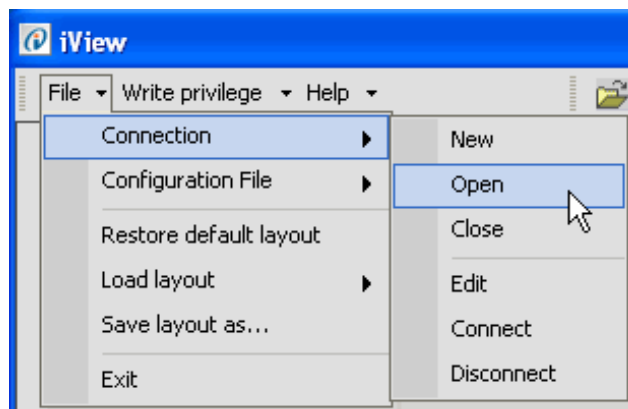
2

8. Enter a *File name* for this connection in the Save As dialog.
9. The suggested (default) location for connections is the *Connections* folder (My Documents > Motion Control Engineering > iView > Connections). You may choose another location using standard windows methods. You may also create sub-folders inside the iController Connections folder in which groups of connections can be stored.
10. Click *Save* to save the connection.

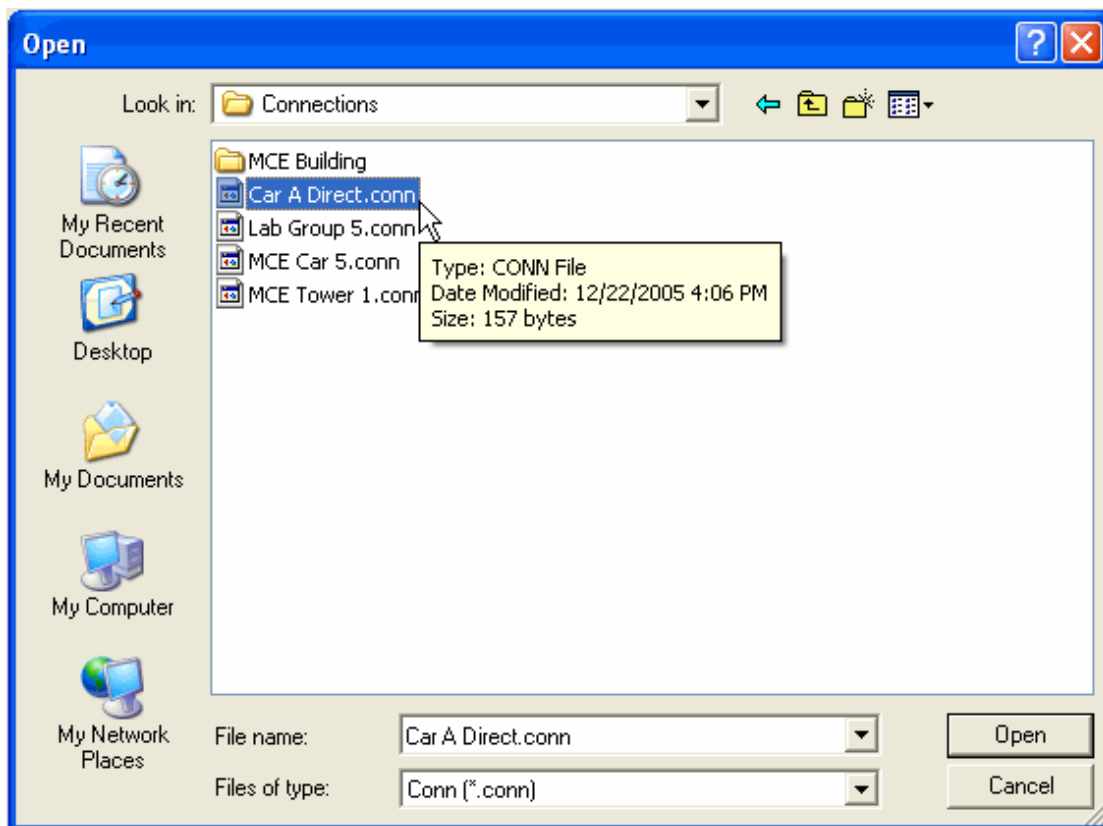


Connecting to the iBox Once the connection is created and saved, you are ready to connect.

1. Click *File* on the menu bar.
2. Select *Connection* and click *Open*.
The Open dialog appears.





3. To connect to a controller, double click the desired connection.



2



4. When iView is communicating with a controller, this symbol  is displayed in the bottom left corner of the iView screen.
5. When iView is not communicating with a controller, this  symbol is displayed in the bottom left corner of the iView screen.
6. When the connection is established, the Operational Status tab and Hoistway window are displayed.

The screenshot displays the iView software interface for MCE Car 5. The main window is titled "iView | MCE Car 5" and includes a menu bar (File, Write privilege, View, Help) and a toolbar with icons for Controller and System. The "Operational Status" tab is active, showing several data panels:

- Speed:** Commanded 0 fpm, Actual 0 fpm, Motor 0 rpm.
- Processor health:** Safety A, Safety B, and Cartop are all indicated as OK with green lights.
- In-service:** Safety OK, System comm, and In group are all indicated as OK with green lights.
- Time remaining for:** Learn switch (15:00 min), Safety bypass (15:00 min), and Fault bypass (15:00 min).
- Motion:** Cmd direction (black square), Actual direction (white square), and Category (AutoIdle).
- Position:** Logical 170.016 ft, Actual 170.016 ft, and Cartop 13563.39 ft.
- Machine:** Mode (Stop), Arm voltage (-0.18 Vrms), Arm current (0.01 Arms), Field voltage (38.28 Vrms), Field current (0.10), Brake voltage (0.47 Vdc), and Brake current (0.03).
- Leveling sensor:** Front and Rear Up/Down leveling markers and Door zones are all indicated as OK with green lights.
- Pattern:** Profile (Idle) and Phase (Idle).
- Door Lock:** Front and Rear are both indicated as OK with green lights.
- Faults:** An empty box for displaying faults.
- Car status:** An empty box for displaying car status.

On the right side, the "Hoistway" window is open, showing a "Passenger" status with a callout of 15. It includes speed and load gauges (0-125 fpm and 0-125%) and a hoistway position chart. The chart shows a vertical scale from 98,000 to 206,000 feet, with a car icon positioned at approximately 170,000 feet. The status bar at the bottom indicates "Local (Alternate Dispatcher)" and the timestamp "12/15/2008 11:41:05 AM".

Verifying Initial Parameter Settings

If necessary, use the operating descriptions in Section 5 to become familiar with using iView and the iView screen descriptions in Section 9. Refer to Table 2.5 on page 2-52 for recommended initial settings.

1. Launch iView and connect to the iController.
2. Once connected, select *Acquire* from the *Write privilege* menu. This is necessary to allow iView to change parameters on the iController. (Note that, when you initially request privileges during each connection session, someone in the machine room must press the “yes” button on the iBox to grant those privileges.)
3. From the *View* menu, select *Layouts* and click *Configuration*.
4. Select the *Pattern tab*. If the Pattern tab is not displayed, select Pattern from the View > Configuration menu.
5. On the *Pattern > Modes tab*, verify the Common, Standard, and Inspection profile settings. Refer to [Table 2.4 on page 2-44](#). Pattern shape preset can be used to enter preset values for the Standard profile parameters based on the high speed (contract speed) of the elevator and the selected shape type (Slow, Moderate or Fast). This provides an excellent starting point. [Please refer to “Pattern shape preset” on page 9-132](#).
6. Edit and Send changes to iControl as needed.
7. Select the *General tab*. If the General tab is not displayed, select General from the View > Configuration menu.
8. On the *General > General tab* set the *Simplex car* selection as appropriate (see [Table 2.4 on page 2-44](#)). DO NOT ENABLE Simplex if the car is part of a group.
9. Edit and Send changes to iControl as needed.
10. Select the *Drive tab*. If the Drive tab is not displayed, select Drive from the View > Configuration menu.
11. On the *Drive > General tab*, verify the *Drive type*.
12. On the *Drive > Safety tab*, verify *Following error* (default 25%, final adjustment procedure in Section 4 of this guide). Refer to [Table 2.4 on page 2-44](#) and the Reference section of this manual (Section 9) for detailed descriptions.
13. Edit and Send changes to iControl as needed.



Note

If you change the drive type, you must press Computer Reset on the iBox so that iControl can “detect” the change on power up.

14. Select the *Setup > Safety > Configuration tab* and verify that *Construction Mode* is checked.
15. Edit and Send changes to iControl as needed.



Table 2.4 Recommended iView Starting Values for Initial Operation

iView Screen Settings						
Pattern >Common tab						
Position Encoder Resolution	256 if MCE iLand system. Otherwise, consult manufacturer documentation.					
Job Contract Speed	200 fpm	350 fpm	400 fpm	500 fpm	600 + fpm	Unit
Pattern scaling	100%	100%	100%	100%	100%	%
Door pre-opening dis.	0.00	0.00	0.00	0.00	0.00	inches
Leveling speed	005	005	005	005	005	fpm
Releveling speed	008	008	008	008	008	fpm
Leveling distance	1.20	0.72	0.60	0.60	0.60	inches
Releveling distance	0.60	0.60	0.60	0.60	0.60	inches
Dead zone distance	0.25	0.25	0.25	0.25	0.25	inches
Relevel dead zone dis.	0.15	0.15	0.15	0.15	0.15	inches
Pattern > Modes tab – Standard Profile						
Job Contract Speed	200 fpm	350 fpm	400 fpm	500 fpm	600 + fpm	Unit
Initial jerk	6.00	6.00	5.00	5.00	6.0	ft/s ³
Acceleration	2.40	3.20	3.40	3.60	3.80	ft/s ²
High toll jerk	6.00	6.00	5.00	5.00	4.00	ft/s ³
High speed	200	350	400	500	600	ft/min
Low roll jerk	6.00	6.00	5.00	5.00	4.00	ft/s ³
Deceleration	2.20	2.90	3.20	3.30	3.50	ft/s ²
Flare jerk	3.00	3.00	3.00	3.00	3.00	ft/s ³
Approach deceleration	1.50	1.50	1.50	1.50	1.50	ft/s ²
Approach jerk	2.00	2.00	2.00	2.00	2.00	ft/s ³
Pattern > Modes tab – Inspection Profile						
Job Contract Speed	200 fpm	350 fpm	400 fpm	500 fpm	600 + fpm	Unit
Initial jerk	6.00	6.00	5.00	5.00	6.0	ft/s ³
Acceleration	2.40	3.20	3.40	3.60	3.80	ft/s ²
High roll jerk	6.00	6.00	5.00	5.00	4.00	ft/s ³
High speed	30	30	30	30	30	ft/min
Low roll jerk	6.00	6.00	5.00	5.00	4.00	ft/s ³
Deceleration	2.20	2.90	3.20	3.30	3.50	ft/s ²
Flare jerk	3.00	3.00	3.00	3.00	3.00	ft/s ³
Approach deceleration	1.50	1.50	1.50	1.50	1.50	ft/s ²
Approach jerk	2.00	2.00	2.00	2.00	2.00	ft/s ³
Low speed	10	10	10	10	10	ft/min
General >General tab						
Simplex car	Set to Simplex if the car is NOT in a group to enable dispatch and parking screens (limited group functionality for a single car).					

Table 2.4 Recommended iView Starting Values for Initial Operation

iView Screen Settings	
Drive > General tab	
Drive Type	Factory set. Verify drive type selected is correct.
Speed Reference	Tachometer
Speed reference scaling	60.000 V/k
Speed ref resolution	Velocity Encoder PPR
Rated motor RPM:	From motor plate.
Coupling rotational ratio	(Brake drum or Sheave Diameter/ Diameter of encoder wheel). If shaft mounted, set to 1.000
Normal rate limited stop	Per job. Default 1 ft/s.
Emerg rate limited stop	Per job. Default 7 ft/s.
Drive > Safety tab	
Following error	25% (factory shipped default)
Safety > General tab	
Pulses Per Foot	Display Only
Contract Speed	Display Only
Contract Overspeed	107% of Contract Speed
Inspection Overspeed	150 feet per minute
Leveling Overspeed	150 feet per minute
Limit One Margin	8%
Top Access Landing	Job specific, check job prints
Top Access Rear	Job specific, check job prints
Bottom Access Landing	Job specific, check job prints
Bottom Access Rear	Job specific, check job prints
No Main String	Job specific, check job prints
No Main String Rear	Job specific, check job prints
Frnt Door Close Contact	Job specific, check job prints
Rear Door Close Contact	Job specific, check job prints
Rear Doors	Job specific, check job prints
Freight Door Option 1	Job specific, check job prints
Rope Gripper	Check to see if a rope gripper is used
Car Top Exit	Check job prints.
Construction Mode	Set to ON .
Door Position Monitor	Check if used (see job prints)
In Car Panel Inspection	Check if used (see job prints)



Caution

Permanent magnet (PM) AC Gearless Machines must be synchronized with the AC Drive. Please refer to *PM Synchronous Motors > Motor Data and Loading motor data from encoder* in the *Initial Start Up* section of the TORQMAX F5 drive manual.

Learning the Safety Configuration

The controller is set to match the job safety configuration, according to the job survey, before being shipped. By default, Construction Mode is also enabled before the controller is shipped. **You should not have to make changes to the Safety screen until you exit Construction Mode.**

The safety configuration for the job is stored in two locations in iControl (FLASH and EEPROM on the SAF board). iControl constantly checks current safety information against stored data and also compares the data in the two stored locations to make certain they continue to match. If you make a change on the Safety screen, you will need to do a “learn” operation to write the new data to iControl:

1. From the *View* menu select *Setup* and click *Safety*.
2. On the *Setup > Safety > Configuration* tab, make necessary changes.
3. Select *Acquire* from the *Write privilege* menu (if you have not yet acquired write privileges to the iBox), then click *Send* to save the changes to iControl.

The controller will generate a safety mismatch fault because the settings you have just sent do not match its stored information.

4. Verify that the iBox is in *Inspection* mode (Inspection switch set to INSP). Set the *Learn* switch to ON.
5. The *Learn* section of the *Setup > Safety > Configuration* tab should indicate that the controller is ready to learn.
6. Click on the *Learn* button. The controller will take a few seconds to learn the new information and will then confirm that the safety configurations again match.
7. Set the iBox Learn switch back to the OFF position.
The message window on the *Safety > Configuration* tab should report Safety Configurations OK.

While iControl is in Construction Mode, specific safety and operational features are automatically bypassed. These are:

- All cartop signals, including DP1 and DP2 (position encoder pulse streams).
- Normal and Emergency limit switches, NTS and ETS velocity and position logic. Except Normal Limit Switches DNTD and UNTD.
- Only Machine Room and Cartop Inspection are allowed. Will not allow Hoistway Access or COP Inspection.
- EQ signals, both seismic and counterweight derailment, are absent.
- Fire sensor signals are absent.
- No cartop comm.

AC Drive Parameters

Each iController is shipped with completed drive parameter sheets and a drive manual. Based on the field survey information, all drive unit, field-adjustable parameters are set and noted on the parameter sheets. However, **it is essential to verify all drive parameter settings before startup.**



Danger

High voltage may be present in the motor circuit, even when the motor is not rotating. Remove AC power and wait for 5 to 10 minutes before removing the drive cover to allow capacitors to discharge. Do not touch any component without verifying that high voltage is not present.

Verify the TORQMAX parameters below before startup. Check remaining parameters using drive documentation or the Quick Reference shipped with the controller. If drive documentation is not available, a list of parameters is included in the Reference Section.



Caution

Do not change drive parameters while the elevator is running. Incorrect settings can cause erratic elevator operation. Please refer to the drive parameters sheet provided with the controller or see [“TORQMAX F5 Drive Parameters Quick Reference” on page 11-27.](#)

- LF.02 Operating Mode = A Spd
- LF.04 Motor-Selection = ICLSD or PgLDD (See Quick Reference in Section 11.)
- LF.05 Fault Reset = 5
- LF.10 Rated Motor Power (HP)
- LF.11 Rated Motor Speed (RPM)
- LF.12 Rated Motor Current (Amp)
- LF.13 Rated Motor Frequency (Hz)
- LF.14 Rated Motor Voltage
- LF.20 Contract Speed (FPM)
- LF.21 Traction Sheave Diameter (inches)
- LF.22 Gear Reduction Ratio
- LF.23 Roping Ratio
- LF.24 Load Weight
- LF.27 Encoder Pulse / Rev (PPR)
- LF.30 Control Method
- LF.31 Kp speed accel / decel (proportional gain)
- LF.32 Ki speed accel / decel (integral gain)
- o.LF.36 Maximum Torque (LB / ft)
- LF.42 High Speed (FPM)
- LF.78 Brake Engage Time
- LF.79 Current Hold Time

Drive Keypad

Become familiar with the drive keypad. Refer to the drive manual to learn how to change drive parameters.

Drive Offsets Calibration

This section describes both the automated and manual procedures which can be used to calibrate the drive analog circuitry. MCE recommends using the automated procedure.

iBox handles processing of drive control voltages digitally. The digital signal is converted to its analog equivalent for output to the drive (DAC). Analog input control voltages are likewise converted from analog to digital for use by the iBox (ADC). Both of these conversions should be checked and any conversion offset corrected using the Output DAC and Input ADC parameters on the Configuration > Drive > Calibration tab.

Automated Drive Setup Procedure

Before adjusting the drive, verify that:

- the iBox Safety OK LED is ON
- the iBox Door Locked LED is ON
- the iBox Fault LED is OFF

1. Display the Drive setup layout (View > Layouts > Drive)

The screenshot shows the 'Setup' window with the 'Drive' tab selected. On the left, there are various offset parameters for 'Offsets' and 'Input ADC'. The main area contains a 'Calibration Status' table and a 'Calibration Data' list. A central instruction box provides steps for performing the calibration.

Calibration Status Table:

	Input ADC	Output DAC	Current sensor	Current loop integral
Inactive	●	●	●	●
Idle	●	●	●	●
N/A	●	●	●	●
Calibrating	●	●	●	●
Internal error	●	●	●	●
Threshold error	●	●	●	●
Calibrated	●	●	●	●
Saved	●	●	●	●

Calibration Data List:

- Current loop integral: 0.000
- Current sensor: 0.000
- Output DAC: 0.000
- Input ADC:
 - Tachometer: 0
 - Brake current: 0
 - Brake voltage: 0
 - Motor field weakening: 0
 - Armature current: 0
 - Armature voltage: 0
 - Abs armature current: 0
 - Motor field current: 0
 - Motor field voltage: 0
 - AC phase A current: 0
 - AC phase B current: 0
 - AC phase C current: 0

Calibration Instructions:

To perform drive offsets calibration, please do the following:

- 1) Obtain 'Write Privilege'.
- 2) Verify machine room 'INSPECTION' switch is in 'INSP' position.
- 3) Toggle 'LEARN' switch to 'ON' position.
- 4) Follow succeeding instructions.

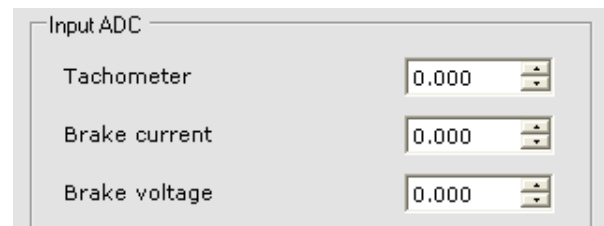
2. Follow the on-screen instructions, “To perform the drive offsets calibration, ...” (calibrates Input ADC and Output DAC offset).

- Once the calibration is *Done*, the offset values shown on the Setup > Drive tab should match those shown on the Drive Configuration tab (Configuration > Drive > Calibration tab).

Manual Drive Setup Procedure

MCE recommends performing the Automated Drive Setup Procedure previously described. However, if the automated procedure is unsuccessful, the manual procedure may be used. The

- Verify that Pattern scaling is set to 100% (Configuration > Pattern > Common tab).
- With zero speed commanded (car idle), verify that the pattern voltage applied to the AC drive unit between F5 drive terminals X2A-1 (+) and X2A-2 (–) reads 0.0 volts. If not, adjust Output DAC on the Drive/Calibration screen by entering and sending small negative or positive values until the reading is as close to 0.0 volts as possible (less than 1mV). The DAC adjustment range is from –0.25 to +0.25 units.
- On iView, display the Drive - Offsets tab (Configuration > Drive > Calibration tab). Also display the Virtual Oscilloscope (View > Virtual Oscilloscope) and set Test point 1 = Tachometer Signal.
- Adjust the Input ADC - Tachometer parameter by entering and sending small negative or positive values until the Test point 1 value is as close to 0.0 as possible ($\pm 20\text{mV}$). The ADC adjustment range is from –0.5 to +0.5.
- Set the Virtual Oscilloscope Test Point 1 = Brake Current Feedback and then adjust the Input ADC - Brake current parameter by entering and sending small negative or positive values until the Test point 1 value is as close to 0.0 as possible.
- Set the Virtual Oscilloscope Test Point 1 = Brake Voltage Feedback and then adjust the Input ADC - Brake voltage parameter by entering and sending small negative or positive values until the Test point 1 value is as close to 0.0 as possible.



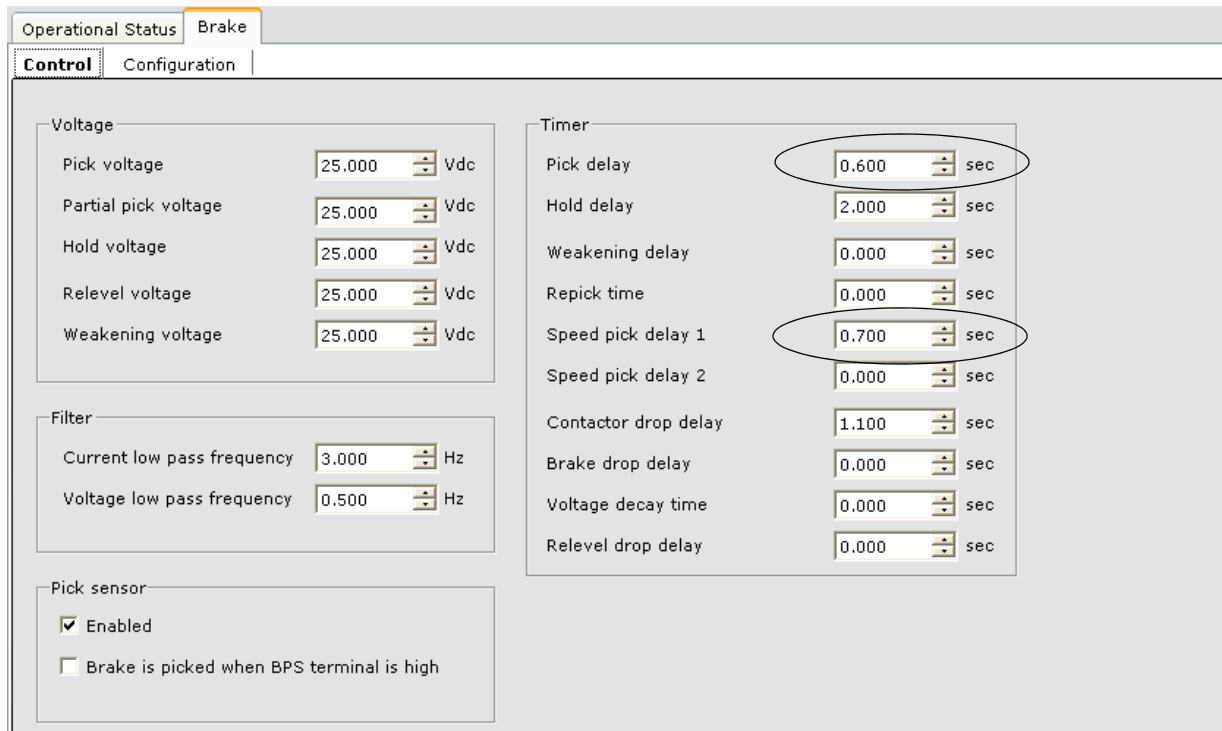
Brake Calibration

This section describes brake calibration for systems using the iField Module advanced braking system. The iField module electronically controls brake voltage output.

Rollback Compensation

In later adjustments, drive and motor settings will be adjusted to control rollback. Since that has not yet been done, we need to control rollback by adjusting Brake Pick delay and offsetting Speed pick delay 1 so that the brake remains set until the motor builds sufficient torque.

1. From the *View* menu select *Layouts* and click *Brake*.



The screenshot shows the 'Brake' configuration window with the following settings:

Section	Parameter	Value	Unit
Voltage	Pick voltage	25.000	Vdc
	Partial pick voltage	25.000	Vdc
	Hold voltage	25.000	Vdc
	Relevel voltage	25.000	Vdc
	Weakening voltage	25.000	Vdc
Filter	Current low pass frequency	3.000	Hz
	Voltage low pass frequency	0.500	Hz
Pick sensor	Enabled	<input checked="" type="checkbox"/>	
	Brake is picked when BPS terminal is high	<input type="checkbox"/>	
Timer	Pick delay	0.600	sec
	Hold delay	2.000	sec
	Weakening delay	0.000	sec
	Repick time	0.000	sec
	Speed pick delay 1	0.700	sec
	Speed pick delay 2	0.000	sec
	Contactora drop delay	1.100	sec
	Brake drop delay	0.000	sec
	Voltage decay time	0.000	sec
	Relevel drop delay	0.000	sec

2. Set *Pick delay* to 0.600 seconds.
3. Set *Speed pick delay 1* to 0.700 seconds.
4. Select *Acquire* from the *Write privilege* menu. Then press the “yes” button on the iBox to grant the privilege.
5. Click *Send* to send the changed values to the controller.

Calibration

Calibration allows iControl to learn the characteristics of the machine brake.

1. Verify that the iBox Safety OK LED is solidly on.
2. Set the iBox Learn switch to ON.
3. Place the iBox Inspection switch in the INSP position. Verify that the iBox displays Machine Room Insp.

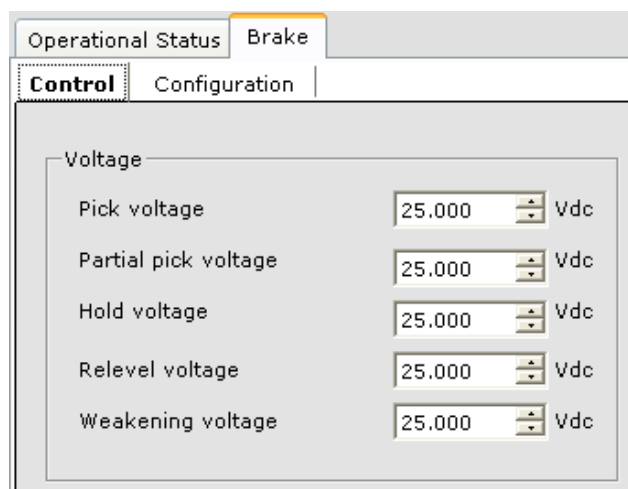
Note

If the iBox does not indicate that you are in Machine Room Inspection even though the Inspection switch is in the INSP position, another inspection mode (i.e., cartop inspection) is probably active. Other inspection modes must be OFF before Machine Room Inspection can be activated.

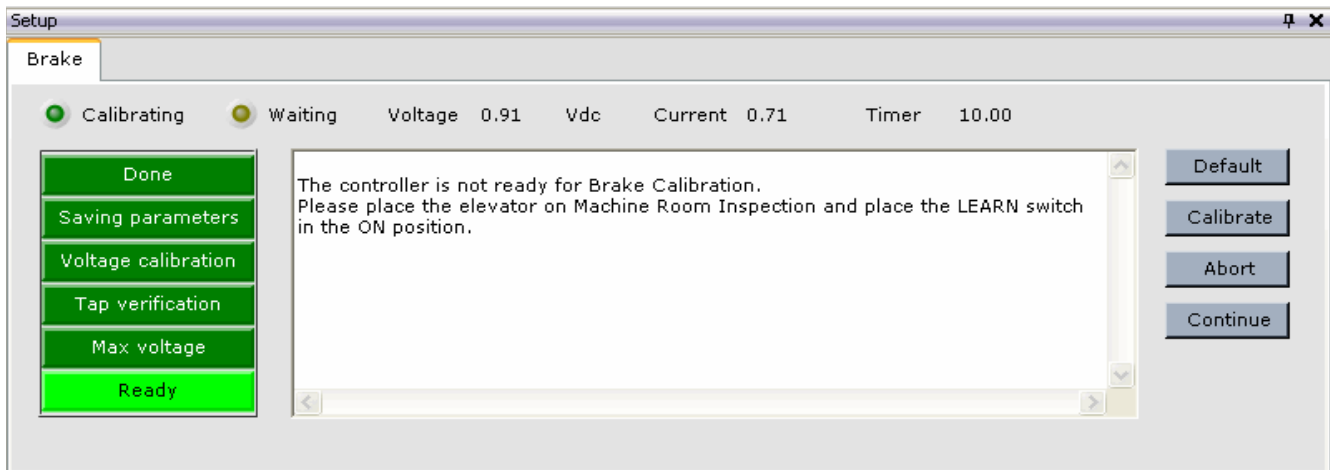


2

4. Display the *Brake > Control tab* (Configuration > Brake > Control tab).
5. Set *Pick voltage* and *Hold voltage* as shown on your job prints.
6. For now, set *Releveling voltage* and *Weakening voltage* to the same value as Pick voltage. (This parameter can be fine tuned during final adjustment.)



7. On the *Setup > Brake tab* the *Ready* indicator should be On. The text box will indicate any steps that need to be performed.
8. With the *Ready* indicator lighted, click the *Calibrate* button. As calibration begins, watch the display on the tab. The display will report calibration progress and will also display instructions if you need to complete additional steps along the way. The *Waiting* LED will light while waiting for an instruction to be completed. If necessary, click *Continue* to continue calibration after performing an instruction.



9. When iControl is ready to begin learning, the screen will display “The controller is waiting for a direction command in order to proceed. You may command either the Up or the Down direction.” When it does, press and hold the iBox Enable and Up (or Down) buttons. (The car will not be moved during this procedure.)
10. The *Calibrating* LED will light as calibration begins. Continue to hold the *Enable* and *Up* (or *Down*) buttons pressed. The progress indicators to the left of the display will keep you informed as calibration progresses.
11. When the *Done* indicator lights, release the *Enable* and *Up* (or *Down*) buttons. Calibration is complete.
12. Set the iBox Learn switch to OFF.

The following messages may be displayed during brake calibration.

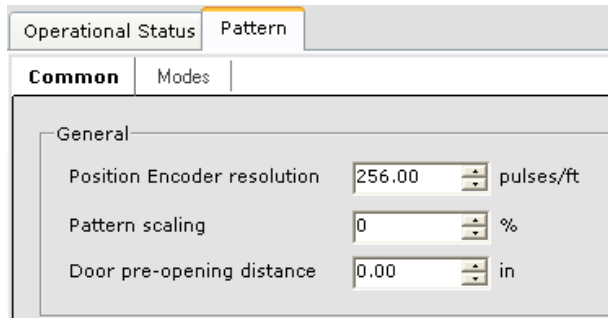
Table 2.5 Brake Calibration Status Messages

Message/Meaning
The controller is not ready for Brake Calibration. Please place the elevator on Machine Room Inspection and place the LEARN switch in the ON position.
The system is waiting for the CONTINUE button to be pushed.
The system is ready to start the calibration process. Push the START button if you wish to start calibrating the brake or push the DEFAULT button if you wish to load the default calibration values.
The controller is waiting for a Direction command in order to proceed. You may command either the UP or the DOWN direction.
The controller is done with brake calibration. Please drop direction and turn the LEARN switch OFF.

Verify Brake Picking

To verify that the brake is picking properly:

1. Verify that the iBox *Safety OK LED* is solidly on. Display the *Pattern > Common tab* (View > Configuration > Pattern > Common tab).
2. Set Pattern Scaling to 0% and click Send to send the changed parameter to iControl.



3. Display the *Operational Status tab*. Note that Brake voltage is charted in the Machine section of the Operational Status tab.
4. With a digital volt meter set to DC volts, measure brake output voltage across terminals B1 and B2 (located just below the iBox panel). (A typical terminal block is shown to the right. B1 and B2 will be labeled.)
5. Press the Enable and Up (or Down) buttons to lift the brake. Verify that the voltages on the volt meter are the same as the commanded voltage (Pick voltage / Hold voltage parameters on the Brake > Voltages tab) and Brake voltage on the Operational Status tab. The brake should lift but the car should not move since Pattern scaling is set to command zero speed.
6. Change the Pick and Hold voltages to one half the current value of the Pick voltage parameter and save the new values.
7. Press and hold Enable and Up (or Down) and verify brake voltage again. (The brake will probably not lift since we are outputting only half the Pick voltage.)
8. Change the Pick and Hold voltages back to their job print settings and save them.
9. Change Pattern scaling (Pattern > Common tab) to 100% and send that value to the controller.



Running on Machine Room Inspection

Once you are satisfied that the brake is picking properly, then do the following:

1. Auto-tuning for induction motors (see below).
2. Verify car movement (direction) and motor control and troubleshoot if not correct (see [“Verifying Car Direction and Motor Control \(TORQMAX\)”](#) on page 2-55).
3. Verify pattern command vs. drive speed feedback tracking (see [“Verify Pattern Command and Drive Speed Feedback”](#) on page 2-56).
4. Calibrate actual car speed (see [“Calibrating Actual Car Speed”](#) on page 2-57).
5. Set Following error, Tach Error Tripping Threshold (see [“Following Error Margin”](#) on page 2-58 and see [“Tach Error Tripping Threshold Adjustment”](#) on page 2-59).
6. Verify electronic motor overload protection (see [“Electronic Motor Overload Protection Verification”](#) on page 2-60).

Auto-tuning for Induction Motors

For best performance with induction motors it is recommended to first perform the auto-tuning procedure as follows:

1. Make sure that the rated motor power (LF.10), rated motor speed (LF.11), rated motor current (LF.12), rated motor frequency (LF.13), rated motor voltage (LF.14) and rated power factor (LF.15) are entered into the drive before you begin. If the power factor is not on the name plate, use 0.90 as the value.
2. On the Controller > Configuration > Brake > Control tab, record the value of Pick voltage, Hold voltage and Relevel voltage. Then set all three voltages = 15.000 to prevent the brake from picking.
3. On the Controller > Configuration > Pattern tab, set *Pattern scaling* = 0.000.
4. On the TORQMAX F5 drive keypad, set Drive configuration (LF.03) = **S L r n**. This will start the learn process. The display will change to **S t A r t**.
5. With the iBox INSPECTION switch in the INSP position, press and hold the UP and ENABLE buttons. The motor contactor should pull in and the brake should not pick. Motor current will begin to flow, an audible noise in the motor will be heard, and the drive display will change to **L S . 1 0 3**.

The drive will measure various parameters in the motor as well as in the drive's own power stage. During each measurement the display will change to signify what is being measured. In the event of problems during the measurement phase, the factory can use the codes to determine what is happening. Continue to press and hold the ENABLE and ON switches in until the drive dapples **done**.

6. In the event that the drive cannot complete the measurements, two error messages may occur:
 - **FAIL d** - the drive was not able to begin measurements due to a configuration error. Consult the factory to resolve.
 - **FAIL** - the measurement sequence was interrupted, e.g., the inspection ENABLE or UP switch was released prematurely, electrically the motor was not properly connected. Try the measurement again.

7. When `done` is displayed, release the ENABLE and UP switches. The drive will finish making several calculations, `CALC` is displayed, and updating the parameter values with the measured values.
8. Return the Pick voltage, Hold voltage and Relevel voltage to their previous values and set Pattern scaling = 100.000 percent.

Verifying Car Direction and Motor Control (TORQMAX)

1. If the brake picks but the car does not move, oscillates, or trips an E.ENC fault, change the F5 drive LF.28 parameter setting. This swaps encoder channels or reverses motor rotation internally in the drive. Physically changing external encoder connections is not necessary and is not recommended. The F5 drive LF.28 options are as follows:
 - 0 = nothing reversed
 - 1 = encoder A<->B swapped
 - 2 = motor rotation reversed
 - 3 = motor rotation reversed and encoder A<->B swapped
2. If the car moves in the opposite of the intended direction while drawing normal current, turn power off and wait until there is no voltage present at the DC bus, then proceed with step 3. Motor current can be verified by displaying the F5 drive parameter LF.93.



Danger

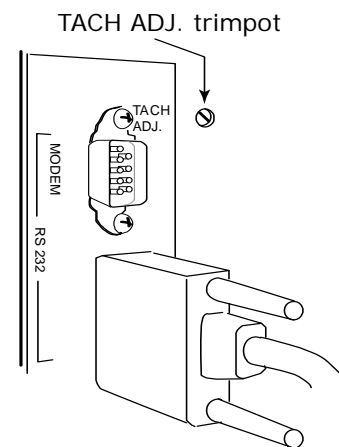
Turn power off and wait five minutes for DC bus voltage to bleed off before taking the drive cover off. Do not touch any terminals without ensuring that high voltage is not present.

3. Interchange two of the motor leads. Turn power on.
4. Try to run the car on Inspection. If the drive still trips an E.ENC fault, again change the F5 drive parameter LF.28. (Refer to LF.28 parameter options in step 1). The car should now move in the correct direction and draw normal current.

Verify Pattern Command and Drive Speed Feedback

1. Verify/set the following iView Drive parameters (Configuration > Drive > General tab > Speed Reference section):
 - Reference type = Tachometer
 - Scaling = 1.000
2. If you change any values, send them to the controller.
3. Display the Virtual Oscilloscope (View > Virtual Oscilloscope).
4. Set Test point 1 = Pattern (Command) and Test point 2 - Speed Feedback.
5. Run the car and verify the polarity (Test point 1 and 2 traces are both moving in the same direction). If they not, change the Speed Reference Direction parameter (Forward / Reverse) on the Configuration > Drive > General tab.
6. Run the car and verify that the Pattern (Command) and Speed Feedback (Test point 1 and 2 traces) are the same amplitude. On the iView oscilloscope (or a DVM connected between STP1 and STP2), compare the Pattern Command and Speed Feedback readouts. They must match within 0.050 VDC while the car is running at steady state speed. If not, adjust the TACH ADJ trimpot (upper right corner of iBox). The iPower Box door can be opened slightly to improve access to the TACH ADJ trimpot. *Turn the pot slowly.* This is a 15 turn trimpot, but the adjustment from maximum to minimum on the virtual oscilloscope is less than 1/2 turn.

*If the trimpot adjustment is insufficient, adjust the Scaling parameter (Configuration > Drive > General tab > Speed Reference section) up or down in 0.1 increments. Remember to *Send* the value to the controller, and then re-adjust the trimpot.*



Calibrating Actual Car Speed

If iLand and iLink are already installed, use the landing system speed (*Speed/Actual* on the Operational Status tab) as the speed reference for speed calibration. If not, use a hand-held tachometer to obtain the value.

If you are using a hand-held tachometer, hold it against the hoist or governor rope on the machine. The car must run at the commanded inspection speed in both directions (see Caution). If the measured inspection speed does not match the commanded value, verify the following:

1. Verify the Inspection - High Speed parameter (iView: Configuration > Pattern > Modes tab or iBox: Car/Pattern Profile/Inspection high velocity).
2. Verify that *Pattern scaling* is set to 100% (Configuration > Pattern > Common tab).
3. Verify drive parameters set earlier. [Please refer to “AC Drive Parameters” on page 2-47.](#)
4. Adjust motor parameter LF.22 Gear Reduction Ratio in small increments to obtain the correct Inspection speed (see Note).



Note

Gear Reduction Ratio: If the gear reduction ratio is not available from the machine name plate, calculate the value by first measuring the motor revolutions using a marker on the motor shaft or brake drum. Reduce the inspection speed by decreasing the Inspection High speed setting, then determine the number of motor shaft revolutions required to complete one revolution of the sheave. Calculate the gear reduction ratio using the formula: Gear reduction ratio = Motor RPM / Sheave RPM. Enter the calculated value in parameter LF.22.

The drive has the capability of estimating the gear reduction ratio. Run the car on inspection and read the value of parameter LF.25, the gear ratio estimated by the drive. The value of LF.25 can be temporarily used for LF.22.



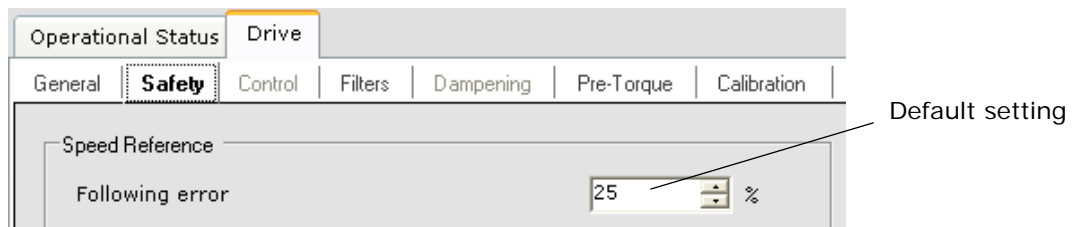
Caution

Up vs. down speed variance: If the car runs at commanded speed in one direction but less than commanded speed in the other direction, this can indicate insufficient voltage available to generate the required torque. At inspection speed this may be a little as 1 or 2 fpm, but at contract speed this variance will be much greater. On a small percentage of jobs it is necessary to increase the value of parameter LF.14 Rated Motor Voltage. For example, for a motor rated for 480 volts it may be necessary to increase LF.14 to 500 volts.

Following Error Margin

The Following error is used for fault detection purposes only. The Following error parameter (Configuration > Drive > Safety tab) sets the allowed margin of deviation from commanded speed, as a percentage. A Tach Error fault is generated when the difference between intended pattern speed and speed feedback exceeds the Following error margin.

1. Verify that the Pattern (Command) and Speed Feedback signals are tracking properly. [Please refer to “Verify Pattern Command and Drive Speed Feedback” on page 2-56.](#)
2. On the Configuration > Pattern > Modes tab, verify that Standard Profile/High Speed and Inspection Profile/High Speed parameters are set correctly for this job.
3. Verify that actual car speed on Inspection is equal to the Inspection High speed setting. [Please refer to “Calibrating Actual Car Speed” on page 2-57.](#)
4. Set the Following error parameter (Configuration > Drive > Safety tab). It is recommended to perform the Tach Error Tripping Threshold Adjustment procedure at this time. [Please refer to “Tach Error Tripping Threshold Adjustment” on page 2-59.](#)



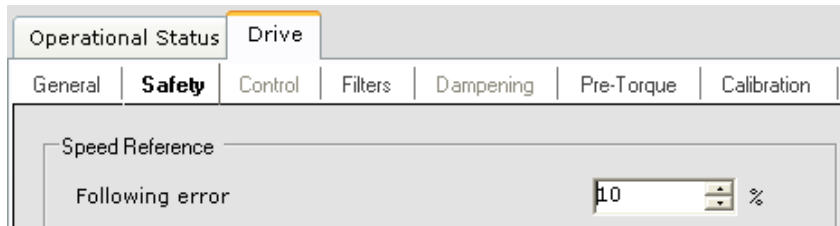
Caution

The default setting for the Following error parameter is 25%. For a car that has been properly adjusted as described in steps 1 through 3 above, after performing the Tach Error Tripping Threshold Adjustment, a Following Error setting of 10% is fairly typical. You may choose to leave the Following error parameter at the default setting or higher, but keep in mind that Following error is a percentage of speed. On a 500fpm job a 25% Following Error allows a 125fpm contract speed deviation before a fault is generated.

Tach Error Tripping Threshold Adjustment

This test compares the pattern signal with the velocity feedback signal and sets the point at which the Tach Error fault trips as a result of excessive error between the Actual and intended car speed.

1. On the iView Virtual Oscilloscope, set Test point 1 to *Speed Feedback* and Test point 2 to *Tach Error Upper Limit*.
2. On Inspection, run the car several times between floors in both directions. Monitor the traces and verify that the Speed Feedback and Tach Error Upper Limit traces track but remain comfortably separated.
3. Set Testpoint 2 to *Tach Error Lower Limit*.
4. On Inspection, run the car several times between floors in both directions. Monitor the traces and verify that the Speed Feedback and Tach Error Lower Limit traces track but remain comfortably separated.
5. Estimate the smallest percentage of Following Error that would allow the Feedback and Limit traces to remain separated.
6. Increase the calculated value by 1/2 and set Following error to this value. For example, if the calculated percentage is 6%, add that to 1/2 of 6 (3) and set Following error to 9%. Remember to send the change to iControl.
7. Repeat steps 1 through 4, verifying that Feedback and Limit traces remain separated. If they do not, recalculate and reset Following error.



2



Note

A Following Error setting of 10% is fairly typical. Keep in mind that Following Error is a percentage of speed. On a 500fpm job a 10% Following Error allows a 50fpm contract speed deviation before a fault is generated.

Electronic Motor Overload Protection Verification

Provided the car is running normally on Inspection operation and is drawing normal current, perform the following test to verify the drive electronic motor overload protection is correctly set to protect the motor from overload conditions:

1. Verify LF.08 (Electronic Motor Protection) is set to ON.
2. Note (write down) the value of LF.09 (Electronic motor protection current). This value must be equal to LF.12.
3. Lower the value of LF.09 to 20% of the noted setting (LF.09 x 0.20).
4. Run the car on Inspection. After one minute the drive should trip an E.OH2 fault and shut down the car.
5. After five seconds, the fault will automatically clear and the car will be ready to run on Inspection again.
6. Set the value of LF.09 back to the noted setting (Motor FLA or LF.12).

Additional Adjustments and Checks

1. On the Configuration > Pattern > Common tab, set *Pattern scaling* to 100%.
2. On the Configuration > Pattern > Modes tab, set *Inspection/High Speed* to the desired value (maximum Inspection speed is 150 fpm). Set the *Inspection/Low Speed* to 25 fpm.

**Note**

If the Terminal Switches (UNT5/DNT5) have been installed, and you wish to use the reduced inspection speed option, you may enable it by checking *Reduced inspection speed* on the Configuration > Pattern > Modes tab. If not, you may enable Reduced Inspection speed after the Terminal Switches are installed. (Enabling it now, without switches, would cause the car to run at 25 fpm.)

3. Stop the car so that the car top can be accessed from the top hall door.

**Note**

NOTE: Car Top Inspection operation automatically overrides Car Panel Inspection operation.

4. Run the car from the Car Top Inspection station, checking the up and down buttons and the stop switch.
5. While running the car, check clearances and door locks. When all doors are locked, remove any jumpers from door lock terminals.
6. Verify directional limit switch and final limit switch operation and position according to page MRW1 or MRW2 of the job prints. The distance between the two switches should ideally be greater than the distance required to stop the car after the direction command is removed when the car is on Inspection operation.
7. Verify that the brake has sufficient tension to hold the car under all conditions likely to be encountered during the installation phase.





Quick Topics

- In this Section
- iLand Installation
- iLink Installation
- Hoistway Switches
- Load Weigher
- Brake Monitoring
- Earthquake Sensor
- Serial Hall Call
- Serial COP
- Voltage Verification
- Door Operation
- Inspection Mode
- Prep for Final Adjust



Inspection Mode

In This Section



This section provides the information you need to complete all field wiring and prepare the elevator to operate in Inspection Mode, including:

- **iLand Landing System Installation** (see page 3-2).
- **iLink Interconnect Installation** (see page 3-13).
- **Hoistway Limit Switches** (see page 3-19).
- **Load Weigher Installation** (see page 3-19).
- **Brake Monitoring** (see page 3-20).
- **Earthquake Sensor** (see page 3-21).
- **Serial Hall Call** (see page 3-22).
- **Serial COP** (see page 3-22).
- **Cartop Voltage Verification** (see page 3-23).
- **Door Operation** (see page 3-24).
- **Running on Machine Room Inspection Mode** (see page 3-26).
- **Preparing for Final Adjustments** (see page 3-28).

3



Caution

Instructions in this section assume you have completed all Construction Mode instructions in the previous section and that the elevator car is running safely and reliably in Construction Mode. Note that, in the course of installing the iLink cartop box, YOU MUST UNDO the temporary cartop CTS bypass used to run the car on Construction Mode (with no iLink cartop box installed).

iLand Landing System

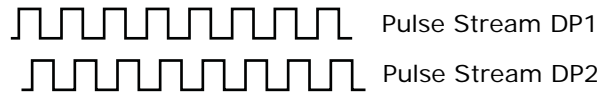
iLand Compact is a rugged, highly accurate landing system. iLand uses an encoder to gauge precise hoistway position and three separate Hall-effect sensors to level the elevator car accurately at each landing. iLand is designed for easy installation and adjustment and to provide maintenance-free service.

Position Feedback

A simple, durable wheel assembly rides the elevator rail as the car moves. Wheel-to-rail tension is maintained by two springs. Mounted with the wheel is a magnet that rotates as the wheel turns. The rotation of the magnet is detected by an integrated circuit (encoder) which generates two pulse streams, phase-offset by 90 degrees. The encoder generates 348 pulses per foot of travel.

Direction

By monitoring both pulse streams, iControl can tell the direction of elevator travel by detecting which stream is the “first to arrive.” For example, when the elevator is moving up, DP1 leads DP2. When the elevator is moving down, DP2 leads DP1.



Position

During floor height “learn” operations, iControl counts the total number of pulses from the bottom to the top of hoistway travel and also stores the floor height position (pulse count) at each landing. During normal elevator operation, iControl uses the floor height information and the encoder pulse count to accurately track the elevator car position in the hoistway. [Please refer to “Learning the Floor Heights” on page 4-2.](#)

Landing Accuracy

During installation, running in Inspection mode, the elevator is manually leveled at each landing. With the car level at the landing, a six-inch strip magnet is placed near the hollow of the rail curvature, vertically aligned with a row of three sensors on the iLand landing system. If the car has both front and rear doors, a second strip magnet is placed on the opposite side of the rail and a second set of sensors is used. Placement of the magnets in vertical alignment with the sensors should be as accurate as possible.

During automatic operation, the iController uses signals from the three sensors (Up Level, Door Zone, and Down Level), factors in speed and position information, and comfortably and accurately “lands” the elevator car to within 1/32” of floor level.

Logic

If required, the Floor Offset Distance parameter may be adjusted to compensate for inexactly placed floor magnets (see *Calibrating the Floor Offsets* in Section 4 of the User Guide). Using this parameter, you can offset the car level-at-floor point by ± 0.5 inches.

The positions of the floor magnets are recorded during hoistway learn operations (see *Learning the Floor Heights* in Section 4 of the User Guide). Each time a magnet is encountered, the iController learns the position of the magnet with respect to the bottom floor. This learned height, the “floor height,” is stored in system memory.

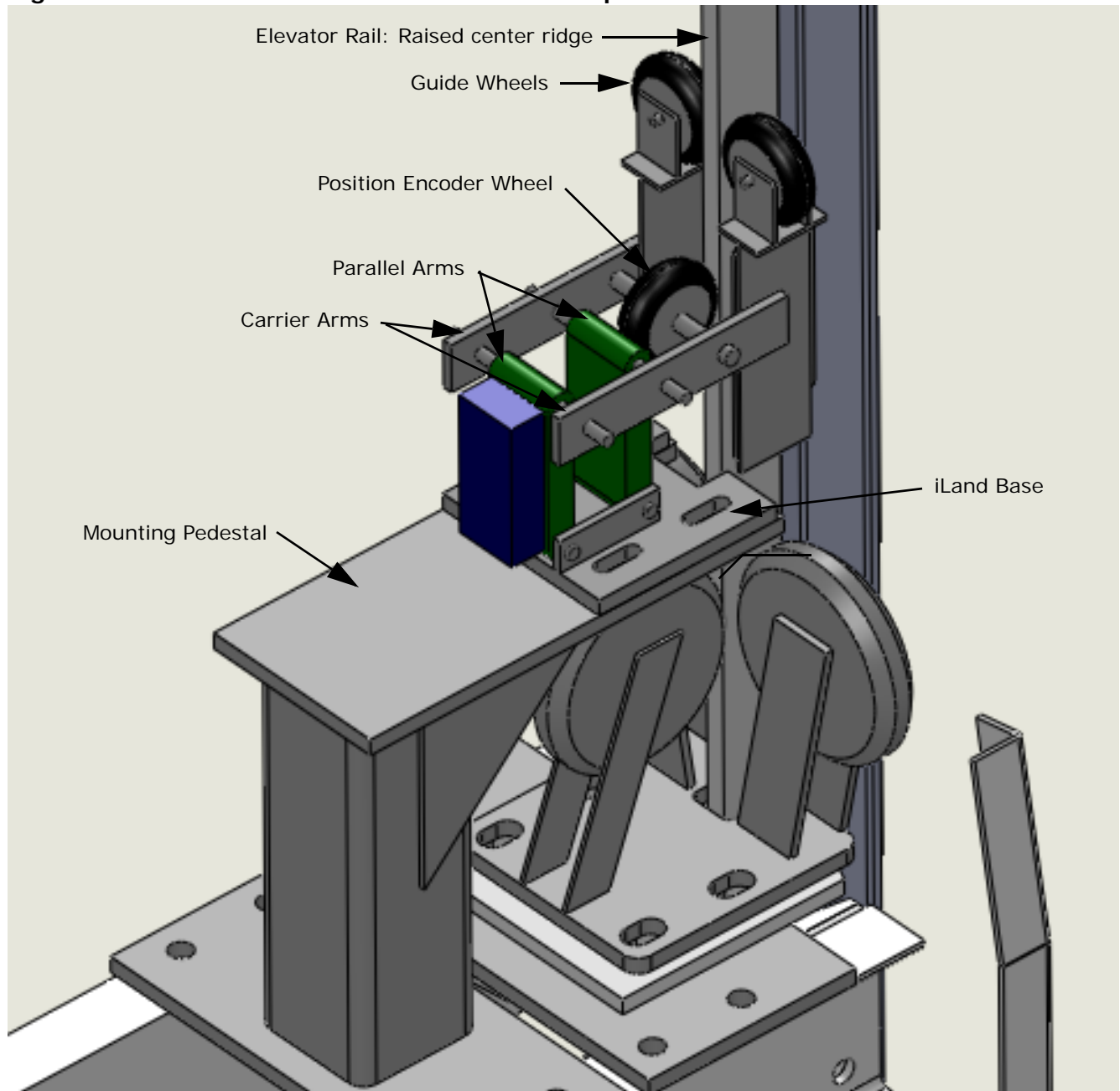
Cartop Mounting

The iLand Compact landing system is usually mounted on a pedestal on the elevator cartop such that the encoding wheel rides the center ridge of the hoistway rail. MCE offers a mounting pedestal designed to work in most installations, or the pedestal may be provided by the installer. Typically, the iLand mounting pedestal is bolted to the crosshead beams.

Positioning

Refer to the illustration below and to the accompanying instructions to ascertain how iLand must be positioned and mounted on the cartop.

Figure 1. iLand Pedestal and Position on Cartop



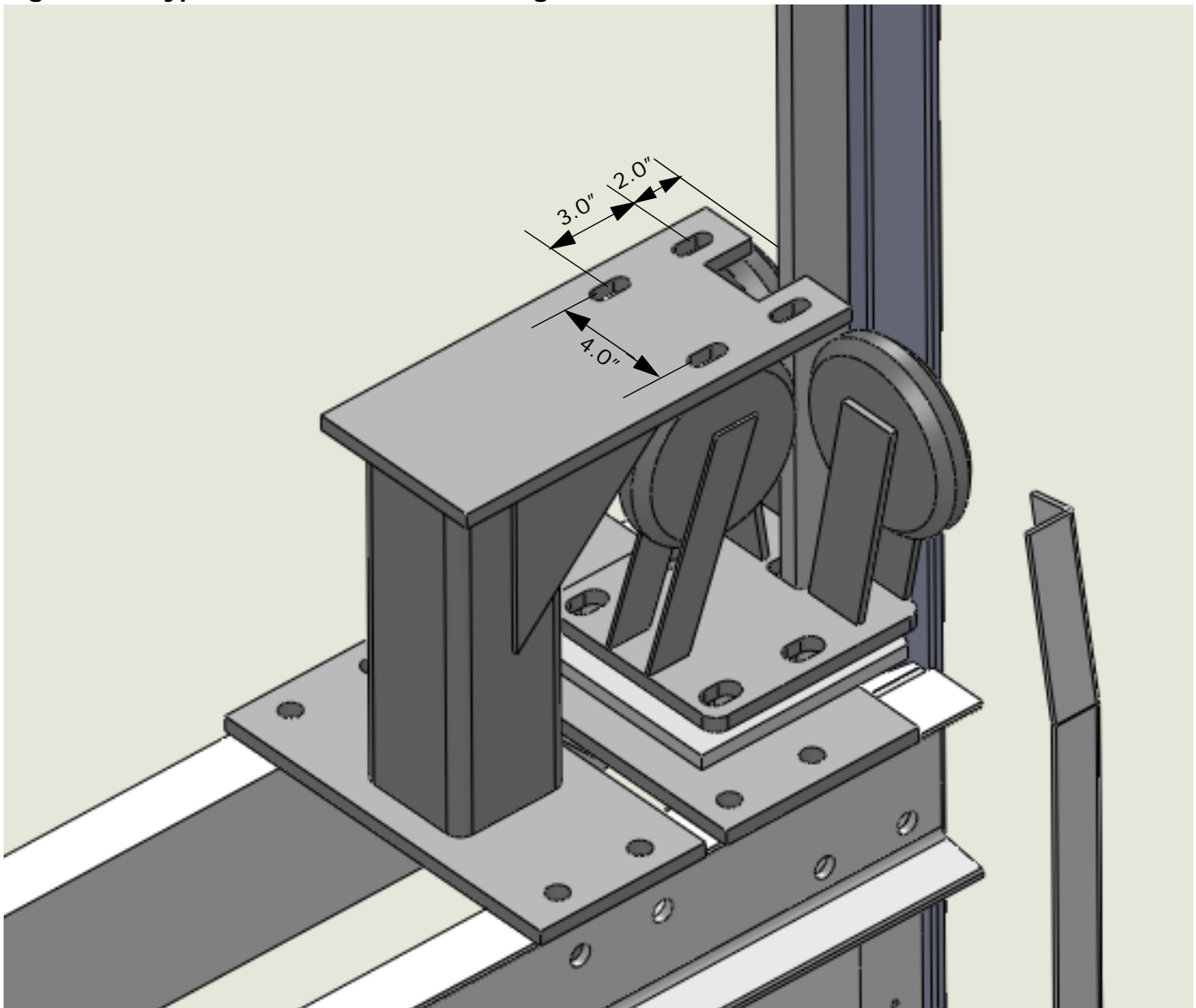
Pedestal Fabrication and Mounting

A pre-fabricated, universal mounting pedestal may be purchased from MCE. If built on site, the pedestal must be fabricated to:

- Mount securely to the elevator car crosshead beam
- Position the iLand Compact system acceptably both vertically and horizontally (vertically so that the landing system clears obstructions like the elevator guide wheels – horizontally so that the encoder wheel is centered on, and aligned with, the raised center ridge of the rail)
- Be sturdy enough to resist flexing or excessive vibration that could cause position information errors

If the pedestal bends or moves, the encoder information might become inaccurate or be interrupted causing the controller to receive inaccurate information about the cars position, speed, and direction of travel. Figure 2 below provides the mounting footprint for the iLand chassis on the pedestal. The slots should provide clearance for 1/2" bolts.

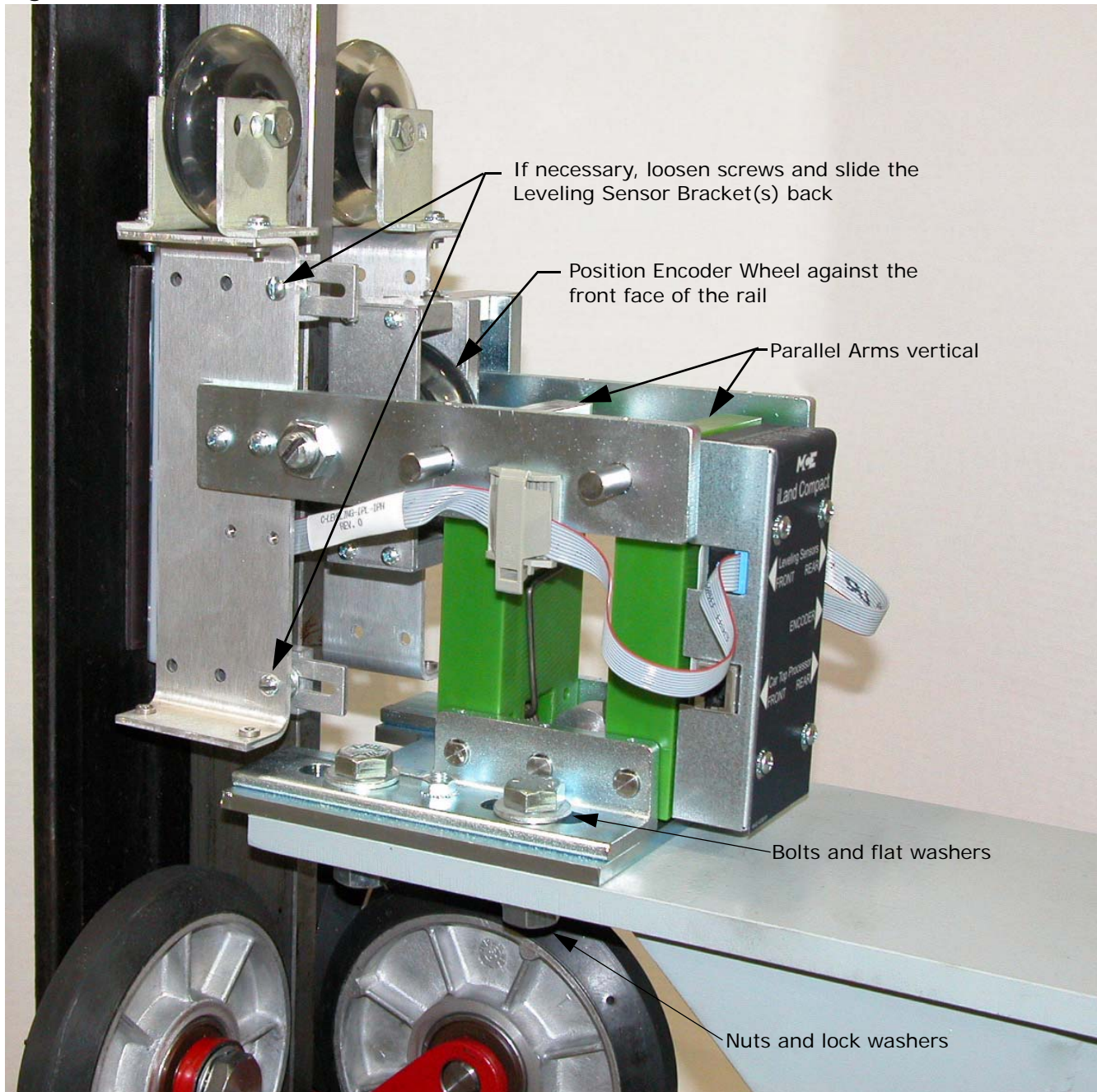
Figure 2. Typical Pedestal for mounting iLand



Installation Instructions

1. Attach the mounting pedestal securely to the elevator crosshead beam.
2. Place the iLand Compact on the mounting pedestal and slide it into position so that the Position Encoder Wheel is touching the front face of the rail. If necessary, loosen the screws that adjust the position of the Leveling Sensor Bracket(s) and slide the brackets back away from the rail.
3. Move the base of the iLand Compact forward until the Parallel Arms are approximately vertical and fasten it to the pedestal using four 1/2" (or 3/8") bolts, flat washers, lock washers, and nuts.

Figure 3.



- Place a magnet on the rail as shown in Figures 4 and 5. below. iLand Compact must be adjusted so that the Leveling Sensors are centered on the magnet with the face of the sensors 1/8" from the surface of the magnet.

Figure 4. Magnet position on the rail (side view)

The front floor leveling magnet and leveling sensors are shown in this picture. The rear floor leveling magnet and sensors, if applicable, is mounted on the opposite side of the rail.

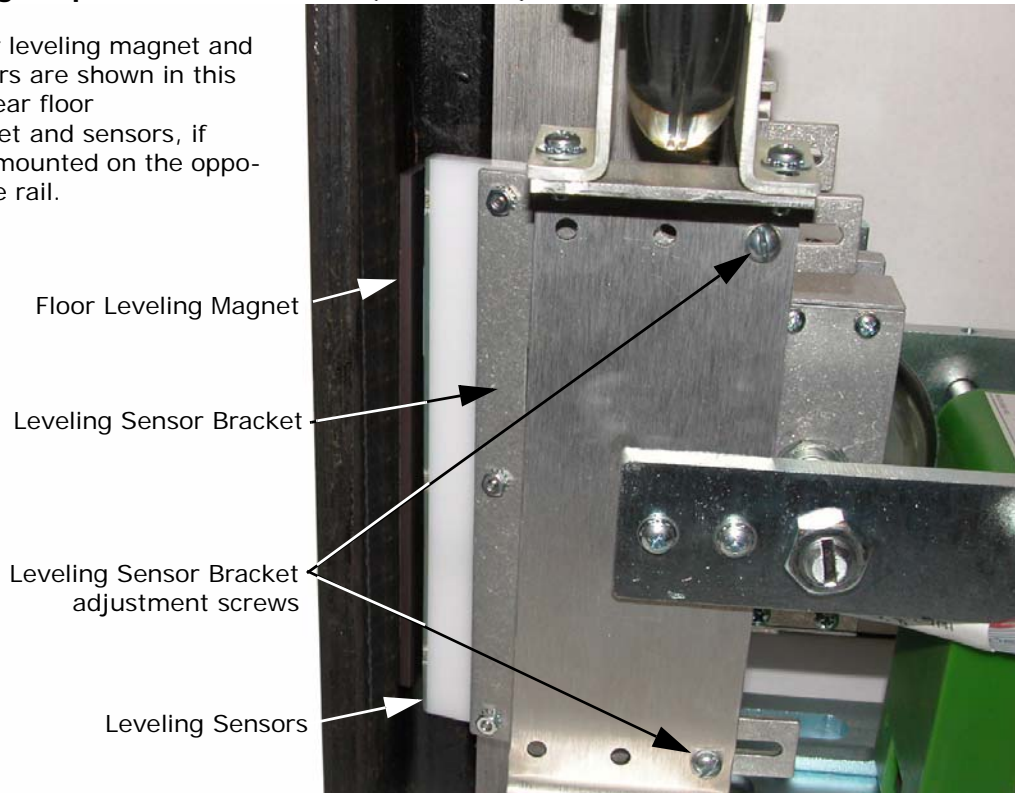
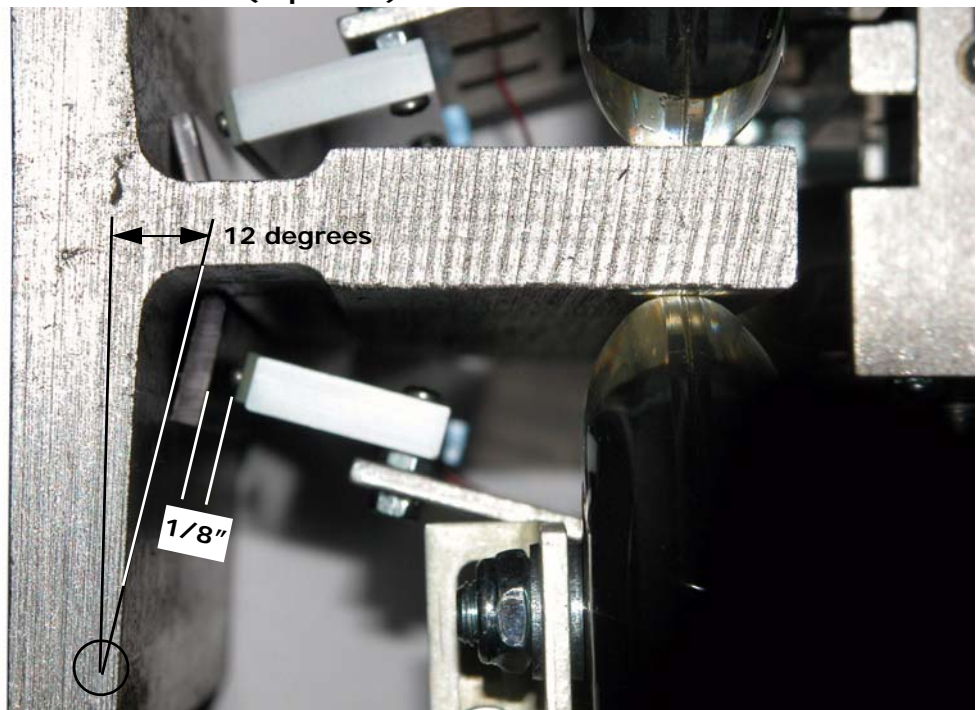


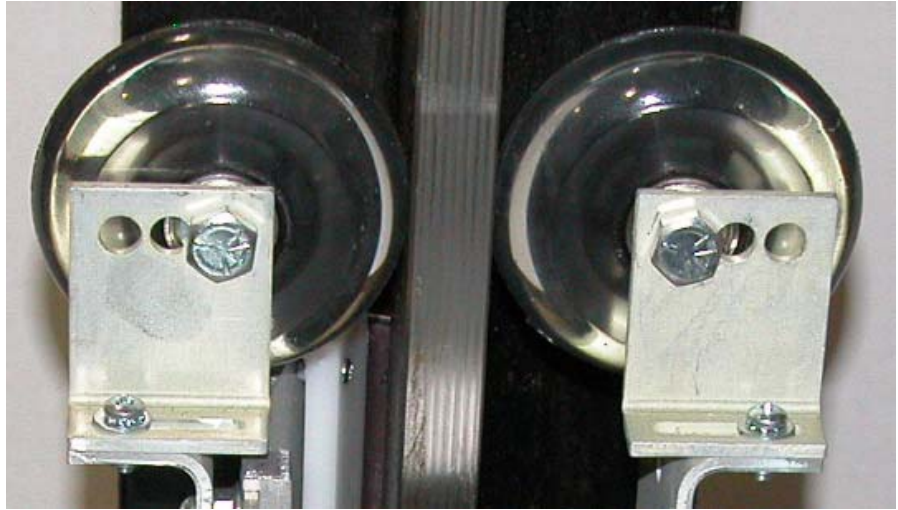
Figure 5. Magnet position on the rail (top view)

The magnet should be on an angle of approximately 12 degrees with respect to the back surface of the rail.

The Leveling Sensors should line up with the center of the magnet and be positioned 1/8" from the magnet surface.



- For a front door only iLand Compact (iLand-1-C), adjust the guide rollers so that the Leveling Sensor is centered on the magnet (see Figures 5 and 6). Ensure that the Guide Rollers are snug against the rail.



- For a front and rear door iLand Compact (iLand 2-C), it may be necessary to adjust both the Guide Rollers (Step 5) and the Carrier Arms in order to get both Leveling Sensors centered on their respective magnets. Loosen the Carrier Arm set screws and move the arms closer together or farther apart (see also Figure 6).



- Once the Leveling Sensors are centered on their respective magnets, adjust the Position Encoder Wheel so that it is centered on the rail. Loosen the lock nut and adjust the screw. Then retighten the lock nut.

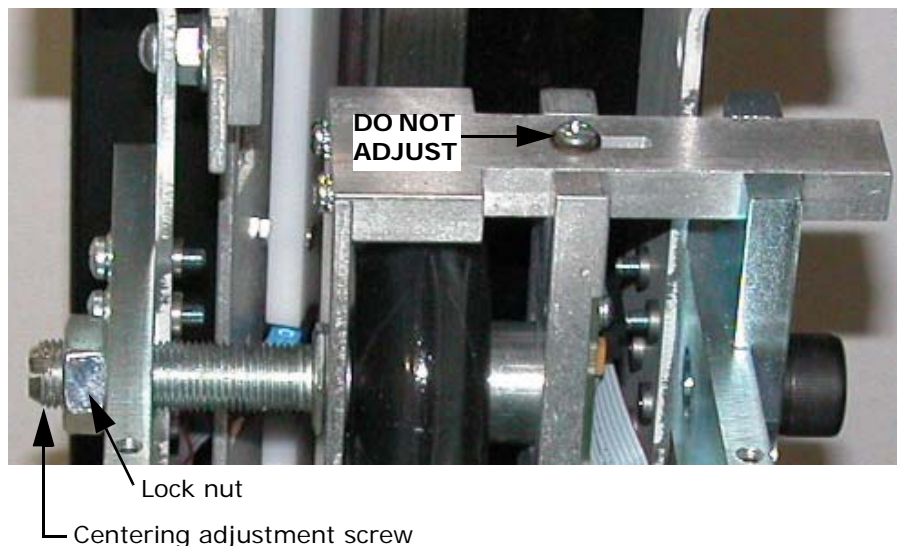
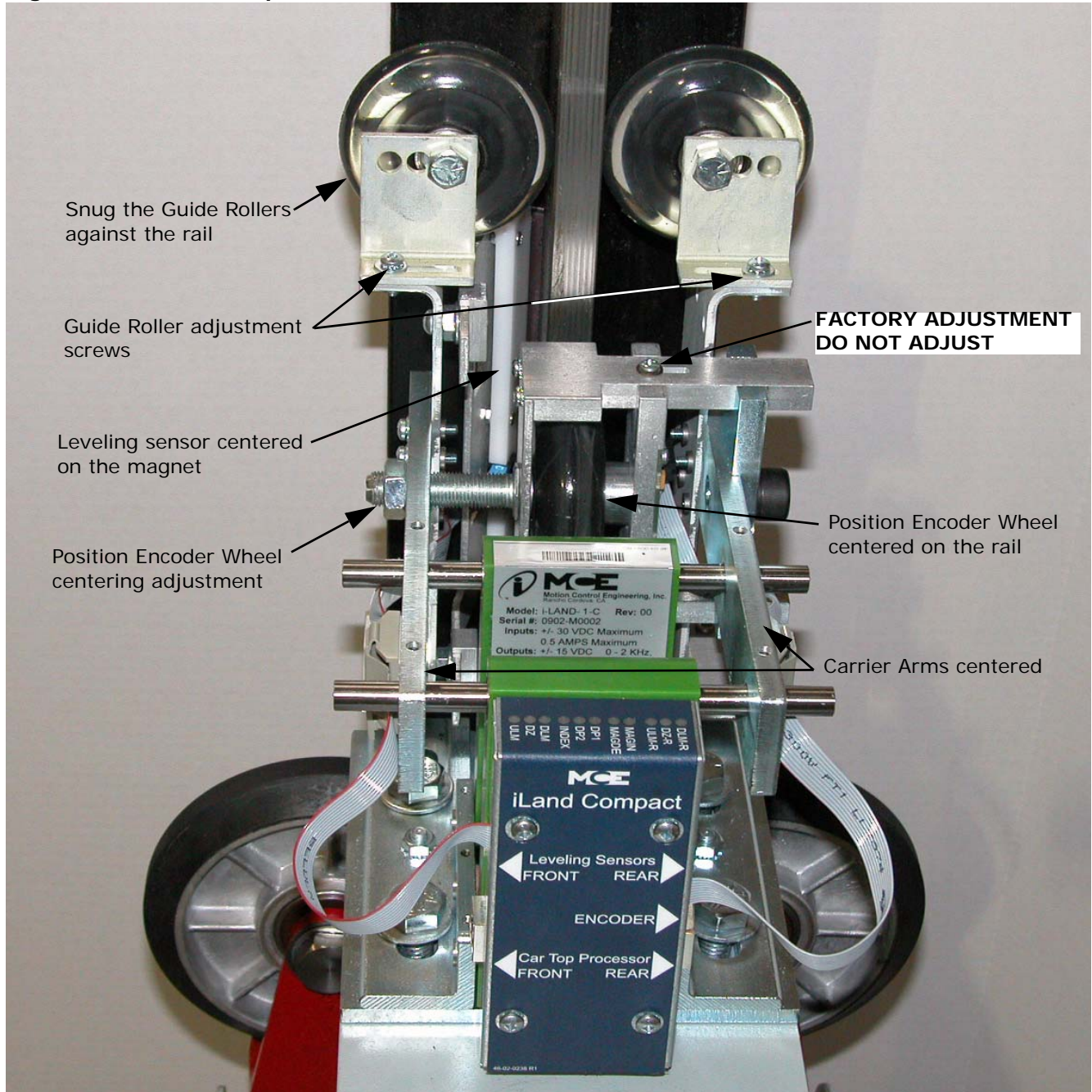


Figure 6. iLand Compact Installation (rear view)



Installing the Floor Leveling Magnets

In a typical, front-door only, installation, a single 6-inch strip magnet placed in the web of the rail (hollow of the rail curve), See [“Magnet position on the rail \(side view\)” on page 3-6](#), is used to indicate the level-with-floor position for each landing at which the elevator car will stop. If the car has rear (or side) doors as well, a second 6-inch strip magnet is placed on the opposite side of the rail and a second set of floor leveling sensors is used.



Note

Blind Hatch - False Floors - Floor leveling magnets must also be positioned in the approximate location of all false floors. Check the Hall Fixture Location section on the Hoistway & Machine Room Wiring (MRW1) page in the job prints. Information regarding false floor settings can also be found on the iView *Floor data* tab (Controller > View > Configuration > General > Floor data). False floors are considered to have only front doors. False floor magnets should be installed only on the front door side.

There are three important dimensions to keep in mind when attaching the floor magnets:

- The magnet must be positioned so that, when the car is level with a floor, the magnet is lengthwise between the Up Leveling and Down Leveling sensors (See [“Magnet position on the rail \(side view\)” on page 3-6](#)) and centered on the Door Zone sensor with the South pole surface facing out.
- The magnet must be attached at an angle of about 12 degrees from the rail hollow (See [“Magnet position on the rail \(top view\)” on page 3-6](#)). (This aligns the face of the magnet with the leveling sensors.)
- The “thickness” of the magnet strips (the distance from the outer magnet face to the rail behind the magnet) must be considered so that some magnets do not “stick out” farther than others. (This ensures that the gap between the sensors and the magnet face will remain consistent at different floor levels.) The iLand assembly automatically compensates for some rail distortion using the Position Encoder wheel and the two guide rollers.

3



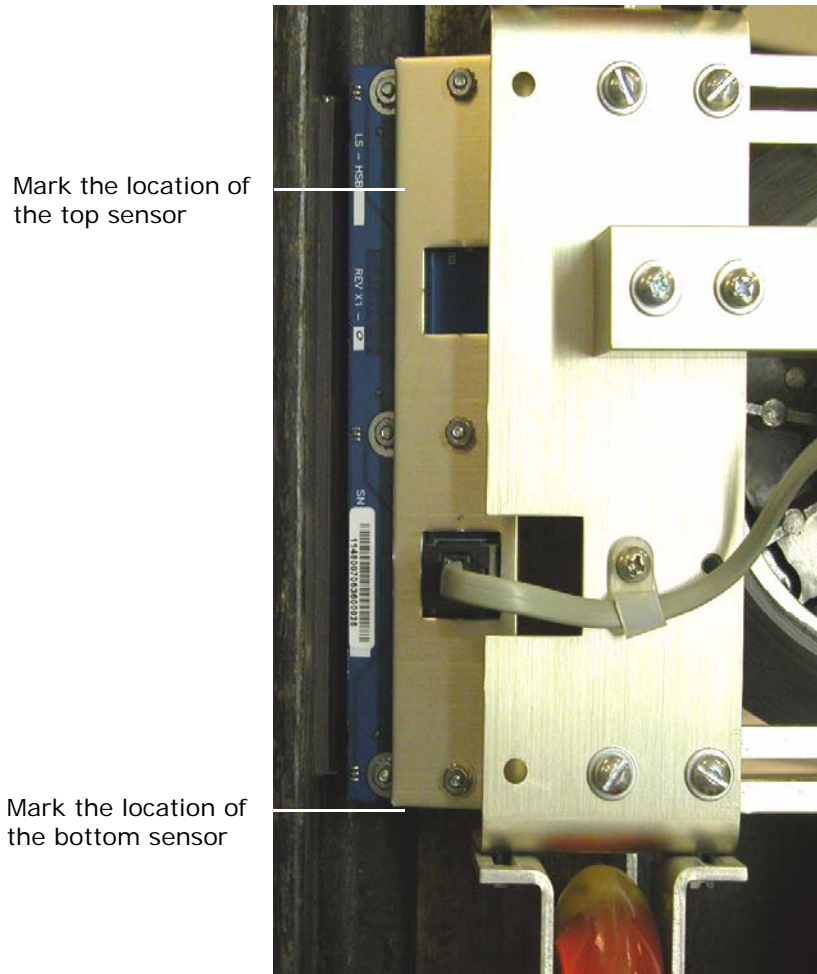
Caution

At points where the rails are attached or where rail sections meet, the clearance for the sensors may be reduced by clamps, bolts, and other hardware. Check your initial floor leveling sensor adjustments at the worst of these points to make certain the sensors or other landing system hardware will not be damaged when the car runs past these points.

In situations where the rail hardware compromises the running clearance of the sensor assembly, we suggest doubling up the magnets at all floors. Extra magnet strips can be ordered through MCE Tech Support.

Floor Leveling Magnet Installation Instructions

1. On Inspection mode, position the elevator car so that it is **level** with a landing.
2. Mark the position of the top and bottom leveling sensors as shown below. Note that the sensors are slightly in from the edges of the circuit board. Accurate magnet position assures the best possible position tracking.

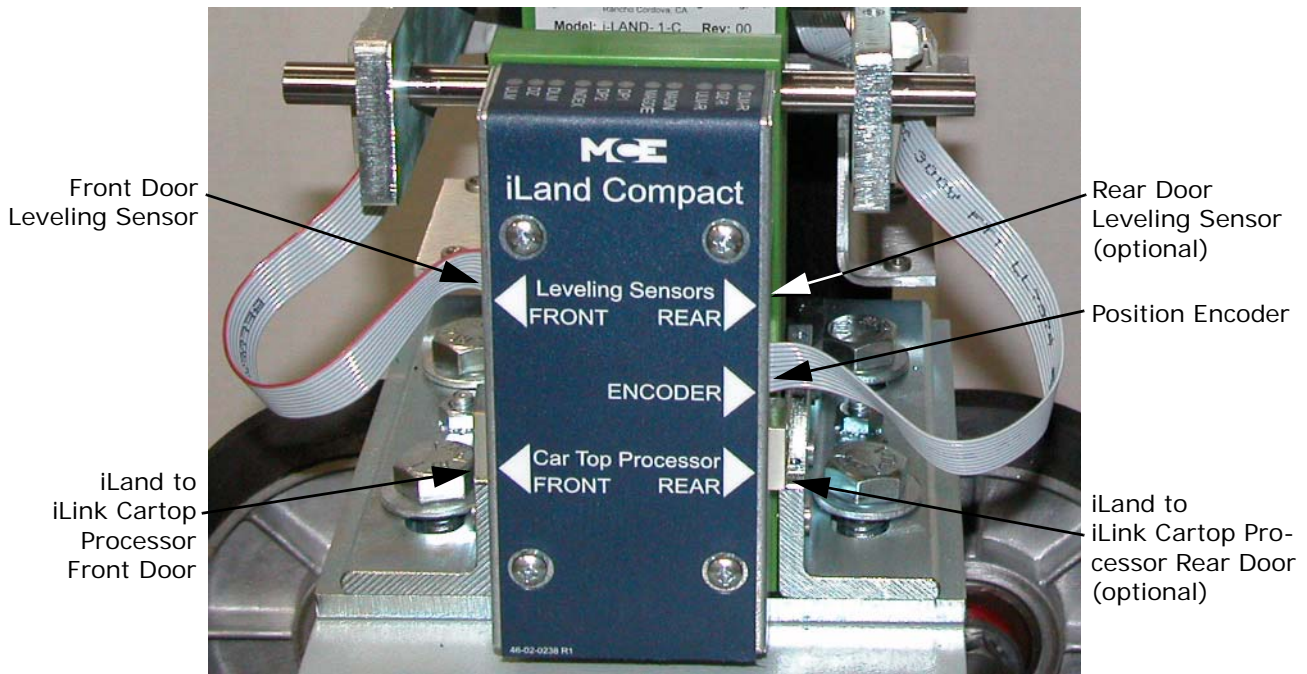


3. Move the car down one to two feet. Clean the hollow of the rail where the magnet will be attached to remove all grease and dirt. (Acetone, alcohol, or another industrial solvent may be used.)
4. Center the magnet vertically between the marks with the South pole facing outwards. (Magnets supplied by MCE have an adhesive strip and paper on the North face. If necessary, use a compass to check North/South polarity.)
5. Move the car back into position and verify that the sensors are within 1/8" (3mm) from the face of the magnet and are centered on the magnet. If the iLand Landing System is powered (connected to a working iLink), the ULM, DLM, and DZ LEDs for that sensor all be lighted if the magnet is positioned properly. If not, adjust the magnet and re-test.
6. When ready, attach the magnet to the rail using a good quality construction glue. Then move to the next landing, etc. (Some installers prefer to temporarily attach the magnets and, after adjusting the sensors and learning the hoistway, test their placement. Then go back and make adjustments before using a permanent glue.)

Cabling Connections

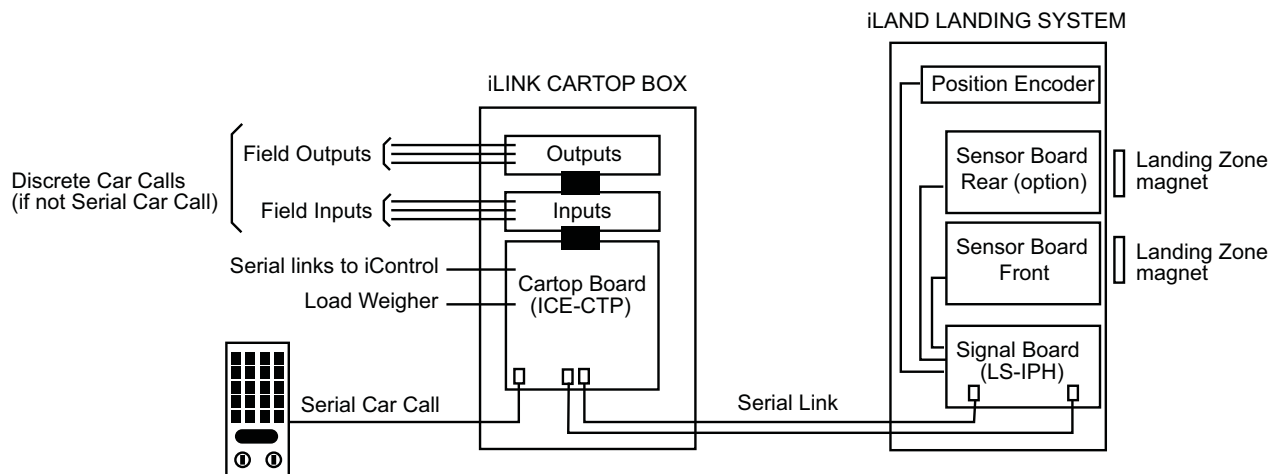
The Position Encoder and Leveling Sensors connect to the iLand Signal board (LS-IPH) through short, factory-assembled cables with an RJ45 connector at each end. These cables should already be in place and connected. If they have been removed, they need to be reconnected. Refer to Figure 7 for guidance.

Figure 7. iLand Cable Connections



The cables from the iLand Landing System (LS-IPH board) to the iLink Cartop Processor (ICE-CTP board) are supplied. They should be routed through flexible conduit from the iLand connectors shown in Figure 7 to the iLand Front Door and, if applicable, iLand Rear Door connectors on the ICE-CTP board in the iLink Cartop Box as shown in Figure 8 (see also “iLink Wiring” on page 3-15).

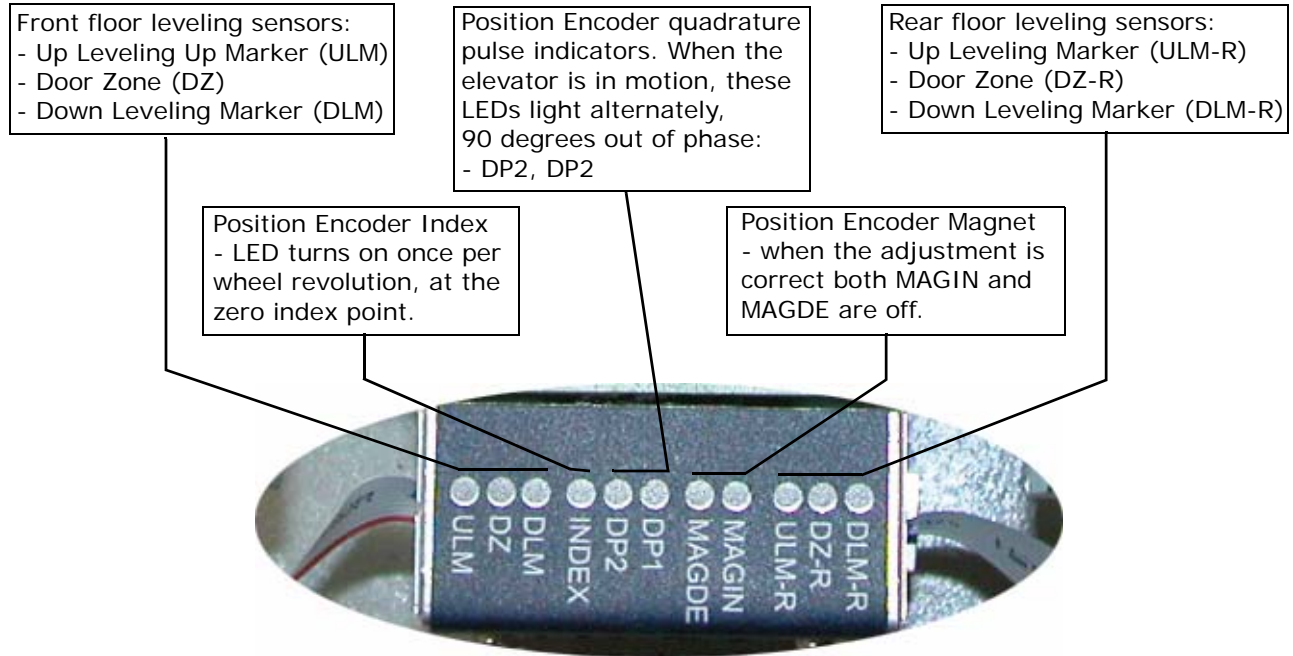
Figure 8. Cartop Interconnection



iLand Status LEDs

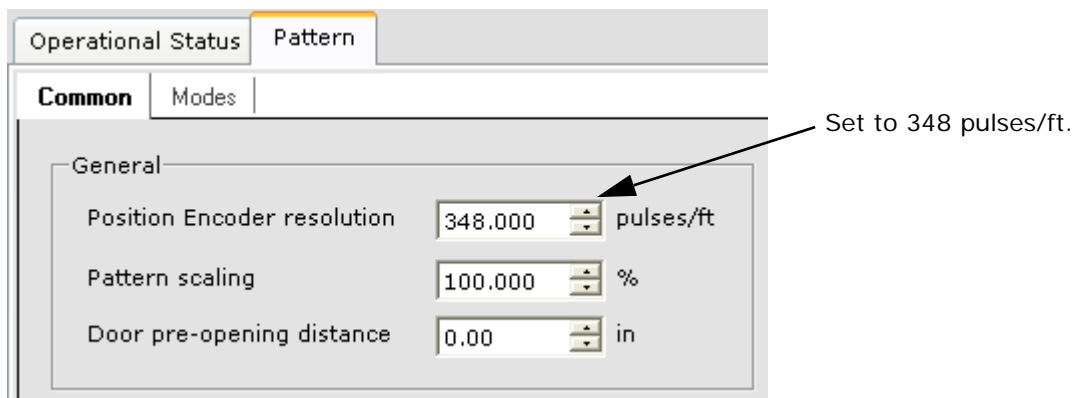
The iLand signal board enclosure reveals status LED sets for the front and rear floor leveling sensors and the position encoder sensor. Refer to the illustration below.

Figure 9. iLand Status LEDs



iView Parameter Setting

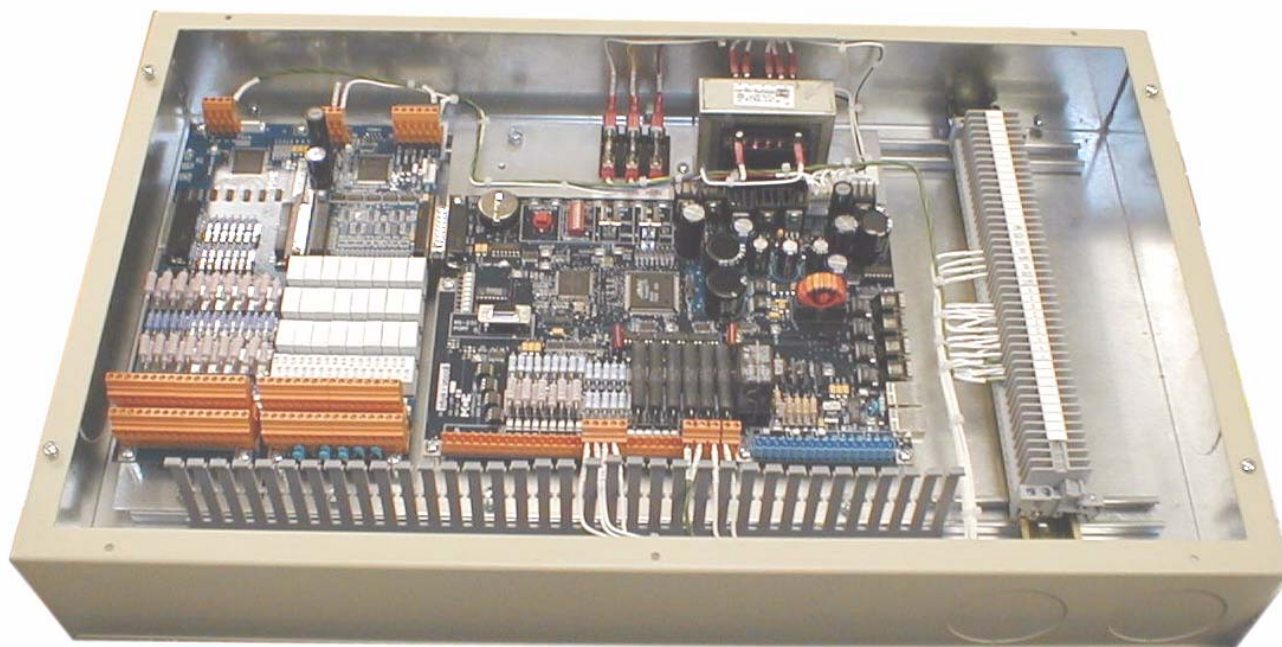
The *Position Encoder resolution* parameter on the iView Controller > View > Configuration > Pattern > Common tab must be set to 348 pulses per foot for the iLand Compact landing system.



Installing iLink

iLink provides an efficient, one-stop interconnect point between car and hoistway wiring and iControl. The serial link between iLink and iControl allows the bulk of the travelling cable to be reduced. The illustration below shows a view of iLink circuitry with the cover removed.

Figure 3.1 iLink Circuitry and Wiring



3

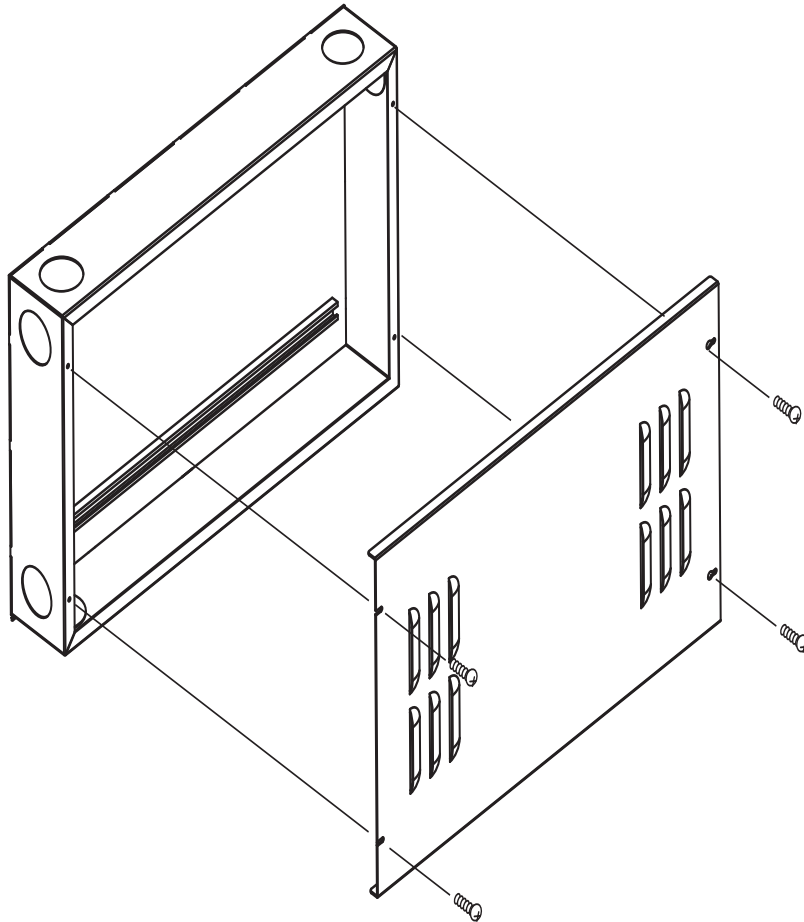
This section describes:

- iLink enclosure installation
- Door signal wiring
- Cartop inspection wiring
- Cartop safety wiring
- Loadweigher wiring
- Door operator wiring

The wiring between the iLand landing system and iLink was described earlier. ([Please refer to “Cabling Connections” on page 3-11.](#))

Installing the iLink Enclosure

The iLink enclosure is typically mounted on the left side (as you face the car) of the cartop, opposite the iLand system. The enclosure has several partially-punched knockouts to accommodate two-inch conduit connections. Mount the iLink enclosure on or between the crosshead beams.



Vertical mounting, as shown, is preferred. Mounting the iLink horizontally is acceptable only if it is well protected from metal filings or other debris that might accumulate and damage electrical components. The dimensions of the iLink enclosure depend upon how many input and/or output boards are required for a particular job.

iLink Wiring

Like iControl, the iLink cartop box has an always-present, processor board (ICE-CTP) connected through a pluggable bus to input (ICE-MIAC), output (ICE-MOR), and other optional boards as required by the installation. A typical layout is shown below.

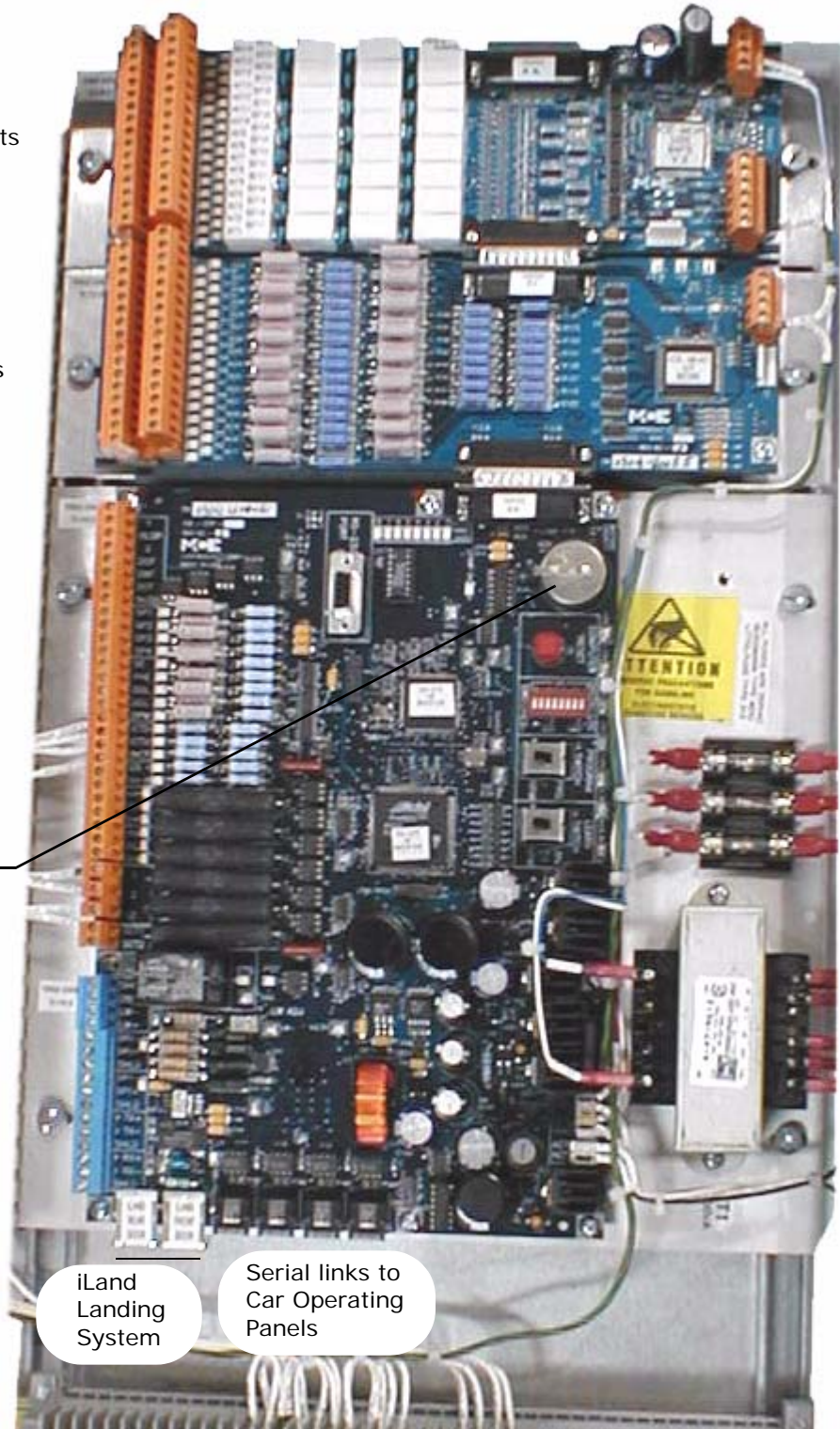
ICE-MOR: Programmable outputs can be used for Car Operating Panel button lamps, buzzers, chimes, peripherals, etc.

ICE-MIAC: Programmable inputs can be used for Car Operating Panel and customer peripheral equipment, etc.

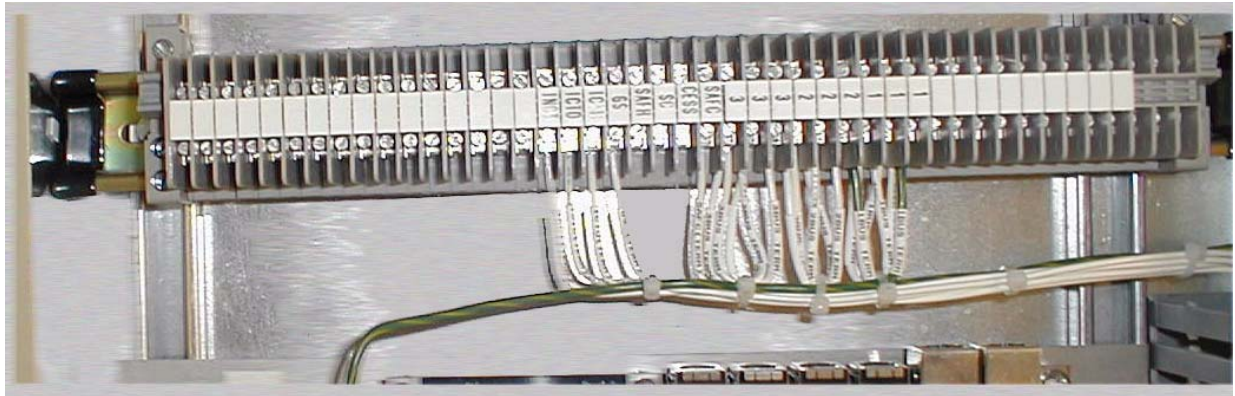
Connections for door operating system, load weigher, etc.

Note

The iLink microprocessor board has battery backup for logic retention. An insulator prevents the battery from discharging during shipment. Remove the insulator now if has not already been done.



A “terminal strip” is mounted in the enclosure. The job prints provide details of terminal strip wiring. A typical terminal strip is shown below.



Front and Rear Door and Leveling Signals

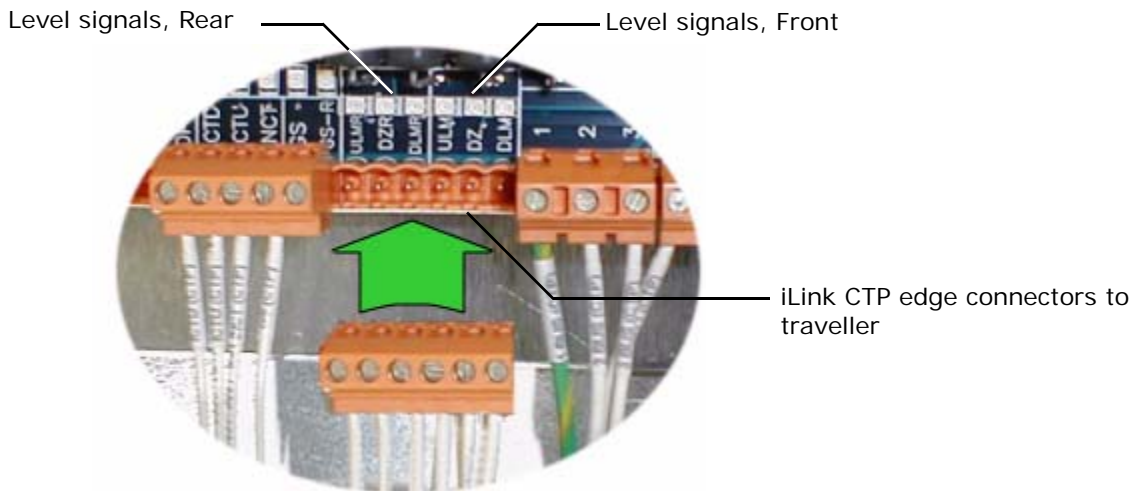
1. Refer to the -CT drawings in the job prints.
2. Connect front and rear door signals as shown.



These instructions assume that the door operator has been installed in accordance with the manufacturer documentation.

Leveling Signals

1. Refer to the -CT job print drawings.
2. Connect the DZ, DLM, and ULM signals between the iLink CTP board and the iControl/iBox for front and rear (if present) doors as shown.



Cartop Inspection Switches

The cartop inspection switches allow you to run the car from the cartop station.

1. Refer to the -CT drawings in the job prints.
2. Connect the cartop inspection switches as shown:
 - INCT: Cartop Inspection Switch enables directional travel switches (active low)
 - ICTU: Cartop Inspection UP button (active high)
 - ICTD: Cartop Inspection DOWN button (active high)

Cartop Safety



Caution

The cartop safety relay may have been temporarily bypassed to run the car on Construction Mode without the iLink cartop box. If so, YOU MUST UNDO this bypass and wire the CTS contact as part of the safety string at SCT1 and SCT2. Refer to your job prints.

1. Locate SCT1 and SCT2. Refer to the -CT drawings in the job prints.
2. Connect the cartop safety switches as shown:
 - Cartop Emergency Stop switch
 - Emergency Exit contact
 - Safety Clamp

Landing System Pulse Streams to iControl

Refer to the iLand installation instructions (Cabling) for a description of the serial/power connections between iLand and the iLink cartop interconnect box. (Please refer to “Cabling Connections” on page 3-11.) The connections described here are between the iLink interconnect box and the controller.

1. Refer to the -CT drawings in the job prints.
2. Locate the DP1+, DP1-, DP2+, DP2-, and Shield connections.
3. Using the shielded, twisted pair connection specified, connect the terminals as shown.

Note

DP1 and DP2 are the quadrature signal from the iLand system that tells the controller the precise position of the elevator car in the hoistway.

iLink to iControl Serial Connection

The processors in the iLink cartop box and iControl controller cabinet communicate serially through shielded, twisted pair, connections.

1. Refer to the -CT drawings in the job prints. Locate the TX+, TX-, RX+, RX-, and Shield connections.

2. Using the shielded, twisted pair connection specified, connect the terminals as shown. (iBox TX+ and TX- terminals to CTP board RX+ and RX- terminals. iBox RX+ and RX- terminals to CTP board TX+ and TX- terminals.)

iLink Power Connections

The iLink cartop interconnect box receives operating power from iControl through the traveling cable. Typically, the power wires are connected to the terminal strip in the cartop box and distributed from there to the circuit boards. Connections between the terminal strip and the boards are made at MCE before shipment but must be verified during installation.

1. Refer to the initial pages of the -CT job print drawings.
2. Connect the power buses as shown, using the wire types specified. The power delivered to the cartop box depends upon the needs of the installation. Refer to the -D3 and -1 (and -2X) drawings for details.

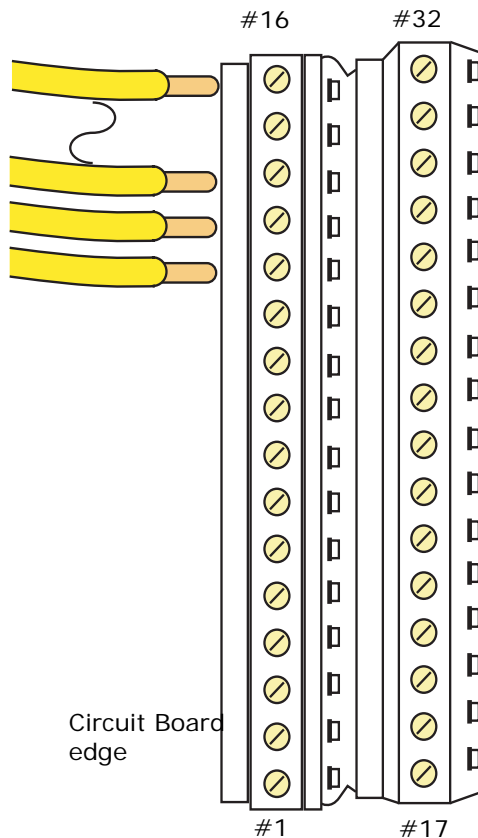
Car Operating Panel Connections

The Car Operating Panel control/power connections are made to the iLink cartop box.

1. Refer to the ICE-MIAC and ICE-MOR areas in the -CT drawings of the job prints.
2. Connect all inputs and outputs as shown.

The drawing below shows terminal order used on both the ICE-MIAC and ICE-MOR boards.

Figure 3.2 ICE-MIAC and ICE-MOR Cartop Board Field Connections



iLink Cartop Wiring Verification

1. Examine the -CT drawings in the job prints package.
2. Carefully verify that all connections have been correctly made and are clean and secure.



Note

Each job is different. The job prints accurately reflect the survey information and are the primary source for installation and wiring information. Review them carefully.

Installing the Hoistway Limit Switches

There are several kinds of limit switches available. If you are using MCE switches, consult the documentation accompanying the switches and the MCE job prints. If you are using switches other than MCE, consult the manufacturers documentation and the MCE job prints. In general (for cam-operated switches):

- Be sure that the cam operating the limit switches keeps the slowdown limit switches open until the normal direction limit switch is broken.
- Be sure that both the normal and final limit switches are held open for the entire run-by travel of the elevator.
- For faster elevators, the surface of the cam that operates the limit switches must be sufficiently gradual so that the impact of the switch rollers striking the cam is relatively silent.



Note

After Terminal Switches (UNT5/DNT5) are installed, verify Inspection Low Speed (iView/Pattern/Inspection) is set to 25 fpm and is enabled. UNT and DNT 5 switches are always used in iControl installations.

Installing the Load Weigher

If a cross-head deflection load weigher is specified for this job, please refer to the installation and calibration instructions supplied with the load weigher. If an EMCO rope tension sensing load weigher is specified, [See “EMCO Load Weigher Installation and Calibration” on page 5-53](#). If an MCE isolated platform load weigher is specified, [See “MCE Load Weigher” on page 5-63](#) (or the instructions shipped with the load weigher) and to the job prints for installation instructions.

Additional information regarding load weigher selection and threshold settings are provided in Section 4. [Please refer to “Load Weigher Adjustment for Dispatching” on page 4-30](#).

Installing Brake Monitoring

Brake monitoring via an independent contact is required by code only for disc brakes. A spare iBox input (SP2D), or a programmable input (Brake Switch) on an ICE-MIAC board, may be used for the brake contact. The brake monitoring contact may be provided as part of the brake assembly. If not, a micro-switch (rated for at least 1/4 Amp, 125VDC) must be provided by the installer and mounted such that when the brake picks, the switch activates (see note below). Refer to job prints for electrical connection information.

The brake monitoring contact provides a path between the iBox 110VDC (#3) bus and the SP2D or Brake Switch input. If the brake fails to pick (or drop) at the proper time, this signal will cause the controller to generate a Brake Pick Fault (see “[Brake Pick Fault, BRAKE PICK FAULT](#)” on page 6-16) or Brake Drop Fault (see “[Brake Drop Fault, BRAKE DROP FAULT](#)” on page 6-15). The fault message is shown on the iBox LCD display, on the iView Operational Status tab and in the iView Event Log.



On the iView > Controller > Configuration > Brake > Control tab, switch parameters are provided to specify the polarity of the SP2D/Brake Switch input (active high or low). In addition, parameters direct the system to monitor for a brake pick and/or brake drop fault. If neither pick or drop monitoring are checked, the controller will ignore the SP2D/Brake Switch input.

Switch

Brake is picked when SP2D or Brake Switch terminal is high

Brake is picked when SP2D or Brake Switch terminal is low

Monitor for brake pick fault

Monitor for brake drop fault



Danger

When installing the switch, take all necessary precautions not to interfere with normal brake design or operation.

Installing the Earthquake Sensor

An earthquake sensor may be part of your installation. If so, connect the counterweight derailment detector and seismic sensor as shown in your job prints. The EQ board provides a seismic sensor input (ESS), a spare sensor input (EQSP 1), and a counterweight derailment detector (CW1/CW2). The ESS input is normally at 120VAC (no earthquake detected). A low (0.0V) at the ESS input will cause the elevator to go into Earthquake Mode.

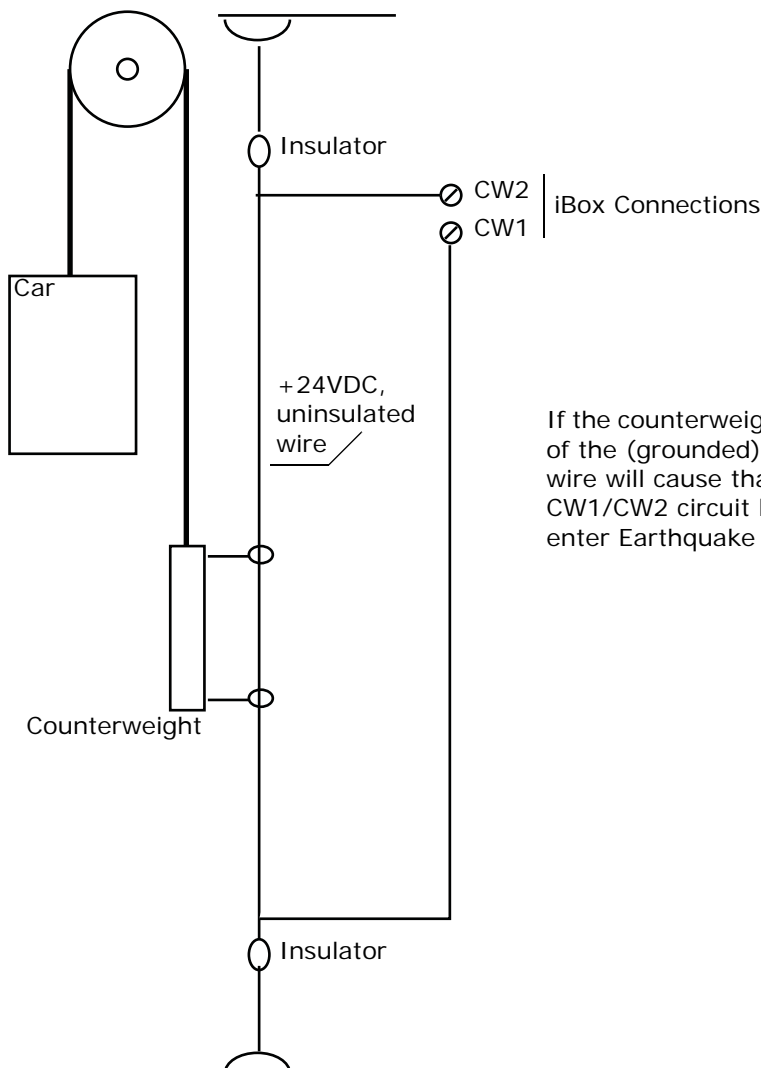
The counterweight derailment detector operates using a 24VDC “ring and string” circuit which will be grounded if excessive counterweight motion occurs. iControl also monitors the continuity of the “string” and will trigger a fault if the string breaks. The illustration below shows how the circuit operates.

Temporary Bypass

If the earthquake devices will be installed later, you may temporarily bypass the ESS input using a jumper from the ESS input to a #2 Bus (120V AC) connection. Bypass the counterweight derailment detector by placing a jumper between CW1 and CW2.

Earthquake Reset

Earthquake Operation latches when activated by the seismic sensor or the derailment detector. Press the reset button on the EQ board in iControl to reset EQ.



If the counterweight moves excessively, one or both of the (grounded) rings surrounding the +24VDC wire will cause that voltage to short, pulling the CW1/CW2 circuit low and causing the elevator to enter Earthquake (operating) Mode.

Installing the Serial Hall Call System

The MCE serial hall call system uses only two wires and is easier to install than traditional, multi-wire systems. The two wires provide both power and signal to hall calls. For simplex cars the hall call driver is located in the car controller cabinet. [Please refer to “Serial Hall Call” on page 5-30.](#)

1. Refer to job print drawings -Serial Hall Call Details (-SH).
2. Set jumpers and install hall call nodes as shown in the drawings.
3. The serial hall call inputs and outputs are programmed on the iView System > Configuration Tabs > System I/O > System tab. [Please refer to “Configuration Tabs - System I/O” on page 10-51.](#)
4. Troubleshooting and testing of the serial hall call fixtures and lamps is accomplished using the iView Configuration > Serial I/O > Bus tab. [Please refer to “System I/O - Bus Tab” on page 10-60.](#)



Note

For cars operating as part of a Group, the hall call driver is located in the Group cabinet. From the iCentral cabinet, calls are distributed to car controllers through the MCE System Ethernet network. Refer to your job prints and the iCue User Guide for installation and cabling instructions.

Installing the Serial COP System

With the Serial Car Operating Panel system, car call buttons connect directly to a serializing board located in the car station enclosure. Multiple Serial COP boards daisy-chain together to accommodate high-rise installations with a lot of call buttons. Wiring from the Serial COP board(s) to the iLink cartop box is just a short length of shielded cable with a telephone-style RJ-11 connector at each end. The iLink cartop box supports up to four serial control panel connections. Communication between iLink and the controller is also serial, thereby reducing the the traveler and hoistway cabling.

Instructions for installing the Serial COP system can be found in Section 5. [Please refer to “Serial COP” on page 5-48.](#)

1. Refer to job print drawings - Cartop Details (-CTx).
2. The Serial COP inputs and outputs are programmed on the iView Configuration > I/O Board > Configuration tab. [Please refer to “Configuration - I/O Boards” on page 9-100.](#)

Verifying Cartop Voltages

1. Set the iBox Inspection switch to the INSP position.
2. Set the Controller Stop switch to the Stop position.
3. Turn on power at the main disconnect.
4. Watch the front panel displays of the iBox, the controller will take about 60 seconds to initialize.
5. Check the Computer, Safety A, Safety B, and Cartop status LEDs. The LEDs should be lighted solid green.
6. Refer to the initial pages of the -CT drawings where power connections are primarily shown. On the cartop, verify all voltages shown are present and within acceptable levels with respect to ground.
 - +5V, +/-15V, +/-26V, +3.3V test points are on the right edge of the ICE-CTP board
 - The GND test point is in the middle of the ICE-CTP board
 - Verify 2 and 3 bus power with respect to the 1 (common) bus
7. Verify the eight diagnostic LEDs on the iLink CTP board. (On power up or reset, these LEDs will light sequentially, first in one direction, then the other, after which they will briefly clear. See the illustration below for normal operating indications.)

Figure 3.3 iLink CTP Board Diagnostic LEDs

- LED 1: iBox to cartop input. Blinks approx. every 40mS. Remains OFF if input lost.
- LED 2: Unintended motion indication. Normally OFF.
- LED 3: Unintended motion indication. Normally OFF.
- LED 4: Cartop to iBox output. Blinks approx. every 40mS. Remains OFF if output lost.
- LED 5: Blinks every 40mS.
- LED 6: ON for Inspection mode. OFF otherwise.
- LED 7: Not used.
- LED 8: Not used.



CTP Board Diagnostic LEDs.
Located near D-connection to MIAC and MOR boards.

8. Install the cover on the iLink cartop interconnect box.
9. Verify that the iBox CARTOP LED is ON indicating that the iLink CTP board is communicating with the iBox. If not, verify that the CARTOP LINK wiring is connected as specified on the job prints. Additional troubleshooting information is available in Section 6. [Please refer to “iControl Circuit Board Quick References” on page 6-82.](#)

Verifying Door Operation

This section helps you verify that the door lock signal input is working properly.

1. Verify that the door related options required for this job are checked on the iView Safety screen. [Please refer to “Setup - Safety - Configuration Tab” on page 9-147.](#)
 - Top Access Landing
 - Top Access Rear
 - Bottom Access Landing
 - Bottom Access Rear
 - No Main String
 - No Main String Rear
 - Front Door Close Contact
 - Rear Door Close Contact
 - Rear Doors
 - Freight Door Option 1
 - Door Position Monitor
2. Simulate the opening of the front car gate by removing the wire from the GS terminal on the iBox.
 - The iBox status LED “Doors Locked” will turn Off.
3. Reconnect the GS terminal.
4. Run the elevator up or down at inspection speed. Remove the DLAT (Door Lock Access Top) input.
 - The elevator should immediately stop.
 - The Door Locked status LED will turn Off.
5. Reconnect the DLAT input. Repeat Step 4 for the DLAB input.
6. Reconnect the DLAB input. Repeat Step 4 for the DLMS input.
7. Reconnect the DLMS input.
8. Run the elevator at inspection speed. Move the Car Door Bypass switch to BYPASS.
 - The elevator should immediately stop since the door lock cannot be bypassed while on Machine Room Inspection.
9. Move the Car Door Bypass switch back to Off.

Verifying the Safety Configuration

Verify that the safety options required for this job are checked on the iView Safety screen. [Please refer to “Setup - Safety - Configuration Tab” on page 9-147.](#) Any options that are checked, but not operational, will require a jumper to allow the car to operate on Inspection (inputs must be high).

Exit Construction Mode

Perform the following checks before exiting construction mode:

1. On the iBox, verify that the green CARTOP LED is lighted indicating that the controller is communicating with the cartop processor board. If not, check the CARTOP LINK wiring. The terminals must be connected as follows: (iBox TX+ and TX- terminals to CTP board RX+ and RX- terminals. iBox RX+ and RX- terminals to CTP board TX+ and TX- terminals.)
2. In iView, display the Operational Status tab. Run the car and monitor the Position - Logical and Position - Cartop values. Verify that the values increase when the car is moving in the up direction. The value(s) could be negative, in which case they must become less negative when the car moves in the up direction.
3. As the car moves, monitor the Leveling Sensor indicators on the Operational Status tab. Verify that the sequence is correct. When the car is traveling in the up direction, the sequence should be, Front/Rear Up leveling marker, followed by Front/Rear Door zone, followed by Front/Rear Down leveling marker.

To exit construction mode:

1. From the iView Write privilege menu, select Acquire.
The iBox LCD will display a message requesting write privileges for iView.
2. On the iBox, press the “Yes” (1) softkey to assign write privileges to iView.
3. Open the Safety screen.
4. Click the Construction Mode check box (remove check mark).
5. Click the Send button.
6. You must then re-learn the Safety Configuration. [Please refer to “Learning the Safety Configuration” on page 2-46.](#)

Running on Machine Room Inspection

When you are ready to run the elevator on Inspection:

1. Verify the iBox Computer, Safety A, Safety B, and Cartop status LEDs are lighted solidly green.
2. Move the Inspection switch to the INSP position.
3. Move the Controller Stop switch to the RUN position.
Within 5 seconds, the Safety OK and Doors Locked LEDs should be on and the Fault LED should be off.
4. Verify that Car Door Bypass and Hall Door Bypass iBox switches are set to the OFF position.
5. Verify that the car is in Machine Room Inspection on the iBox or in iView. If the car is in another inspection mode (i.e., Cartop Inspection, In-car Inspection, or Hoistway Access), turn them off. The INCT, INA, and INCP inputs on the left edge of the iBox should be high (110VDC).
6. Press and hold the iBox Enable button, then press the Up or Down button to run the car on inspection. Run the car away from the terminal landing.
7. On the iBox or on the iView Hoistway screen, verify car speed (Actual Speed). Use the iBox or iView Actual Speed as the speed reference. Use TORQMAX drive parameter LF22 to calibrate speed if required. [Please refer to "Verifying Car Direction and Motor Control \(TORQMAX\)" on 2-55.](#)

Verifying Quadrature Pulse Sequence and Encoder Resolution

Position Encoder Resolution

Verify that Position Encoder Resolution (Pattern Configuration/Common tab) is correct. When the iLand landing system is mounted on the car top with the encoder wheel against the hoistway rail, Position Encoder Resolution is 256 pulses/ft. (Please refer to “iLand Landing System” on page 3-2.)

Quadrature Pulse Sequence

The quadrature pulse sequence must be verified before the hoistway can be learned.

1. Connect to the controller using iView.
2. Open the Hoistway screen. Display the Faults tab.
3. Move the car up the hoistway. Verify that Actual Position and Cartop Position increase.
4. Move the car down the hoistway. Verify that Actual Position and Cartop Position decrease.

If the quadrature pulses are reversed, the Position Quadrature Reversed fault will appear in the Faults display after the elevator moves about two feet. (The Actual position may decrease as the car moves up and increase as the car moves down.) If indications are not correct:

- Check the DP1+/DP1- and DP2+/DP2- connections to the iBox and iLink (refer to the job prints).
 - If the connections are correct, use a multi-meter to test that the positive- and negative-going pulses are arriving at the terminals. The streams should pulse between -15 and +15 volts.
 - If the signals are not arriving properly, check the cartop connection between the iLand landing system and the iLink interconnect box. (Note that the Front Door/Front Magnets cable must be present between the interconnect box and the landing system regardless of your door/magnet configuration because it provides power to the landing system.)
5. If iLand to iLink cabling is correct, first test the continuity of the cables, then check the traveler connection between the iLink and the iBox for correct connections and continuity.

Prepare for Final Adjustments

This section describes preparing for final adjustment.

Door Operator

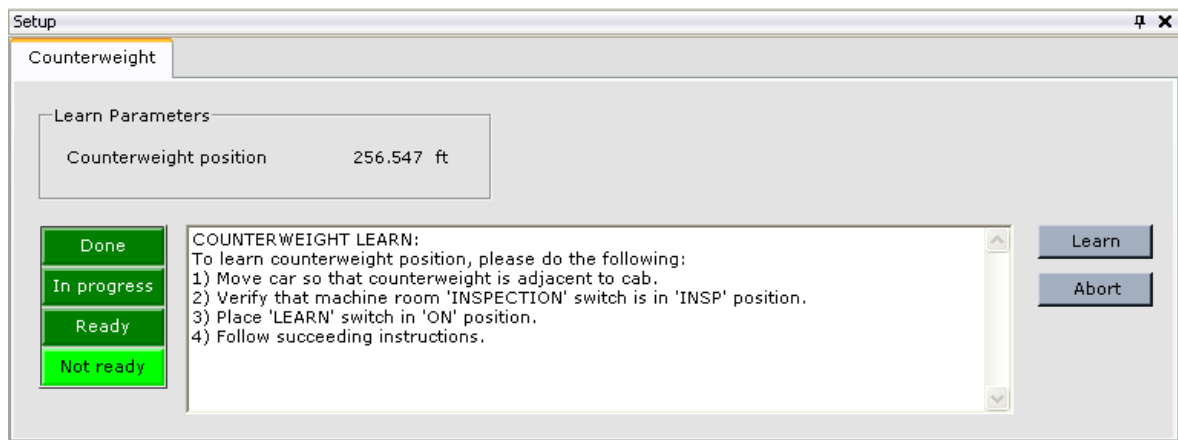
The door operator must be working properly before final adjustment.

1. Verify that the door fuses are properly installed.
2. Verify that the iBox Car Door Bypass and Hoistway Door Bypass switches are OFF.
3. Check that all door equipment clutches, rollers, etc. are properly adjusted to correct running clearances.
4. Check the controller prints to make sure any door operator diode installation instructions have been followed (especially for G.A.L. door operators).
5. Verify that all hoistway and car doors are closed and locked.
6. Run the car through the hoistway on inspection mode to make sure the hoistway is completely clear.

Counterweight Learn Procedure

This procedure allows the controller to learn the hoistway position at which the car and counterweight are at the same height. It must be performed if the controller will be using Earthquake operation, and it is helpful for counterweight balancing and pre-torque gain adjustment.

1. Move the car until the car and the counterweight are at the same height in the hoistway.
2. Place the iBox Inspection switch in the INSP position.
3. Place the iBox Learn switch in the ON position.
4. Display the Counterweight setup tab (View > Setup > Counterweight).



5. If *Not ready* is lighted, follow the instructions in the message window until *Ready* is lighted.
6. With *Ready* lighted, click the *Learn* button.

The controller will learn the car/counterweight position and the *Done* indicator will light. The learned Counterweight position is displayed on the Setup > Counterweight tab.

7. Set the iBox Learn switch to OFF and the iBox Inspection switch to NORM.

Counterweight Balancing

On modernizations, the weight of the car is often changed but compensating adjustments to the counterweight are sometimes overlooked. This adjustment is important for achieving desired performance and ride characteristics. The following are two ways in which the car / counterweight balance can be verified:

Option 1 (preferred method)

1. Place a balanced load in the car (specified percentage of full load; typically 40%).
2. On Inspection, run the car to the middle of the hoistway to the position learned by performing the Counterweight Learn Procedure (see “Counterweight Learn Procedure” on page 3-28). Verify the position using the *Actual* Position displayed on the Operational Status tab.
3. Turn controller power OFF.
4. Use a portable supply to inject sufficient DC voltage at controller terminals B1 and B2 to lift the brake. (Or, manually lift the brake.)
5. Watch the car to see if it drifts. If not, the car and counterweight are balanced.
 - If the car drifts up, remove weight from the counterweight or add weight to the car and repeat the balancing procedure.
 - If the car drifts down, add weight to the counterweight or remove weight from the car and repeat the balancing procedure.
 - For a drum machine, follow the manufacturer counterweighting recommendations and test the drum machine limit switches.
6. When car and counterweight are balanced, record the actual weight in the car for future reference. Balanced load = _____ lbs.
7. Restore controller power

Option 2

1. Place a balanced load in the car (specified percentage of full load; typically 40%).
2. On Inspection, run the car to the middle of the hoistway to the position learned by performing the Counterweight Learn Procedure (see “Counterweight Learn Procedure” on page 3-28). Verify the position using the *Actual* Position displayed on the Operational Status tab.
3. On the TORQMAX drive keypad, monitor the phase current parameter LF.93 while the car is traveling at steady speed (not accelerating or decelerating).
4. Starting from the middle of the hoistway each time, run the car up and then down and note the current in each direction. If the currents are equal, the counterweight is close to the correct value.
 - If more current is required to run the car up, add weight to the counterweight or remove weight from the car and repeat the balancing procedure.
 - If more current is required to run the car down, remove weight from the counterweight or add weight to the car and repeat the balancing procedure.
 - For a drum machine, follow the manufacturer counterweighting recommendations and test the drum machine limit switches.
5. When the car and counterweight are balanced, record the actual weight in the car for future reference. Balanced load = _____ lbs.

Run Testing

1. Verify all landing system magnets are installed according to job prints and instructions.
2. On inspection mode, run the car to the midpoint of the hoistway.
3. Set the iBox Test switch to the ON position.
4. Place the car on Machine Room Inspection, with Cartop Inspection OFF.

At this point, the car should be on Inspection operation and running without oscillation. There may be substantial rollback when the car first starts.

5. On the iView Virtual Oscilloscope, set Test point 1 to *Pattern (Command)*.
6. Use a digital voltmeter to check the pattern voltage on iBox test point STP1 with respect to the Common terminal.
7. Verify that Pattern scaling is at 100% (Configuration > Pattern > Common tab) and the Inspection - High speed parameter is at 10% of contract speed (Configuration > Pattern > Modes tab). Maximum value for Inspection - High speed is 150fpm. Verify that the Reduced inspection speed option is enabled and that Inspection - Low speed is set to 25 fpm.
8. Run the car on Inspection and check the voltage at iBox test point STP1. If 8.0VDC is equal to contract speed, then the reading at 10% should be 0.8VDC (+/- 5%).
9. Set Inspection - High speed to 50fpm.
10. On Inspection, run the car to, or near, the bottom landing. Use test weights to load the car to 125% of full load in preparation for checking the ability of the brake to hold this weight.



Danger

If the brake does not hold, the car may slide into the pit. Use extreme caution.

11. On Machine Room Inspection, run the car up the hoistway sufficiently to allow a down direction run.
12. On Machine Room Inspection, run the car down the hoistway. While the car is moving, set the iBox Controller Stop switch to STOP to force the brake to apply while the car is moving. If necessary, adjust the brake to hold the load.
13. Remove the weights from the car.

Empty Car Tests

With the car on Machine Room Inspection and with test weights removed (empty car), the following steps allow you to adjust the response of the car to reduce empty car rollback while avoiding the oscillations that can occur if too much gain is adjusted into the system. For these tests you may use a storage oscilloscope capable of a 1.0 centimeter per second sweep rate or you may use the iView Virtual Oscilloscope

1. On the iView [Virtual Oscilloscope](#), set Test point 1 to *Speed Feedback*. Adjust the Virtual Oscilloscope for greater sensitivity and shorter timer period. [Please refer to “Controller - Layouts” on page 9-153](#). If you are using a storage oscilloscope, monitor iBox test point STP1 (lower right side of the iBox) with respect to Common.

The empty car will probably drift up due to the counterweight, even when an attempt is made to move it down. Perform the following:

- TORQMAX Drive: Verify the drive gain parameters:
 - A.LF.31 - Kp speed accel (proportional gain) = 3000
 - d.LF.31 - Kp speed decel (proportional gain) = 3000
 - A.LF.32 - Ki speed accel (integral gain) = 350
 - d.LF.32 - Ki speed decel (integral gain) = 250
- 2. Adjust brake *Pick delay* and *Speed pick delay 1* (iView Configuration > Brake > Timers tab) to coordinate the application of the speed pattern with the picking of the brake to avoid movement of the car under the brake or rollback of the car. A DRO fault may occur if brake Pick delay is reduced to a value lower than 0.30. Generally, brake Pick delay is set to 0.40 and Speed pick delay 1 is set to 0.50 or slightly higher. (For TORQMAX drives, verify that LF.70 = 0.300 (Delay to turn on DRO).
- 3. Experiment with improving response. A little rollback at this point is not critical as later adjustments will compensate for it.
- 4. Verify that Pattern scaling is 100% (Configuration > Pattern > Common tab).
- 5. Using the iView Operational Status tab (Speed/Actual) or a hand held tachometer, verify that Machine Room Inspection car speed is 10% of Standard - High speed (contract speed) and matches the Inspection - High speed setting. [Please refer to “Calibrating Actual Car Speed” on page 2-57](#) if necessary.



Danger

At this point, the Fault/Function Bypass switch on the iBox should be in the OFF position. Fix all faults so that no fault is bypassed before proceeding. If this is not possible, exercise **EXTREME CAUTION** while making final adjustments.





Quick Topics

- In this Section
- Learning Floor Heights
- Verifying One Floor Run
- Reaching Contract Speed
- Learning Limit Switches
- Shaping Speed Profile
- Controlling Initial Start
- Calibrating Floor Offsets
- Adjusting Leveling
- Load Weigher Adjust
- Pre-Start Sequence
- Safety Verification
- Safety Tests
- Terminal Switch Faults



Final Adjustment

In This Section



This section describes the sequence of steps required to make final adjustments to, and complete final inspection of, the elevator system. At this point, all steps in Sections 2 and 3 should have been completed.

- **Learning the Floor Heights** (see page 4-2).
- **Verifying One-Floor Run Operation** (see page 4-3).
- **Reaching Contract Speed** (see page 4-7).
- **Learning Normal & Emergency Terminal Limit Switches** (see page 4-9).
- **Shaping the Speed Profile** (see page 4-12).
- **Controlling the Start of Car Motion** (see page 4-16).
- **Calibrating the Floor Offsets** (see page 4-23).
- **Adjusting Leveling and Final Stop** (see page 4-26).
- **Load Weigher Adjustment for Dispatching** (see page 4-30).
- **Pre-Start Sequence** (see page 4-35).
- **Calibration and Verification of Safety Functions** (see page 4-41).
- **Safety Tests** (see page 4-43).
- **Terminal Switch Faults** (see page 4-55).

Learning the Floor Heights

Learning the building includes determining the location of each floor. iControl does this by counting pulses sent by the position encoder on the iLand landing system as the elevator travels the entire length of the hoistway from bottom to top. The iLand position encoder produces 256 pulses per foot of travel.

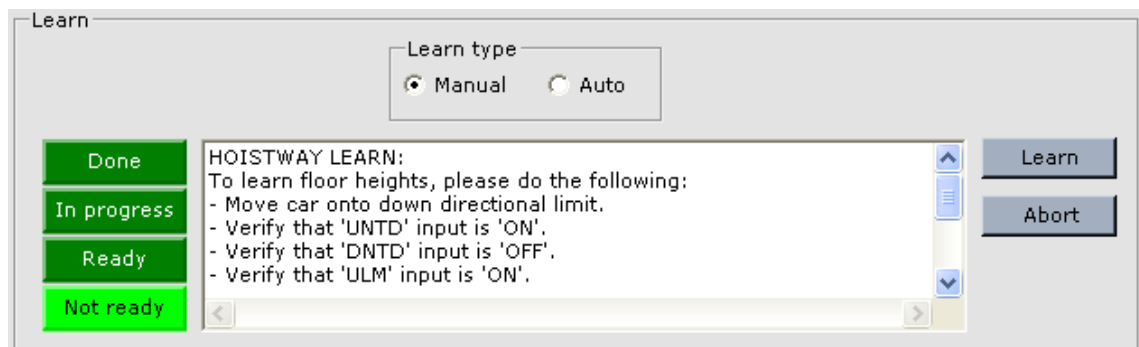
Note

This is one of the procedures that must be successfully completed before running the elevator on Test or Normal operation. Before proceeding, be certain you have verified the landing system quadrature pulse sequence. Please refer to “[Verifying Quadrature Pulse Sequence and Encoder Resolution](#)” on page 3-27.


Floor Height Learn Procedure

The speed at which the car learns the hoistway is determined by the Inspection /High Speed parameter (Configuration > Pattern > Modes tab). For learning the floor heights, we recommend setting Inspection/High Speed between 50fpm and 125fpm. To complete the learn operation:

1. Place the car on Inspection operation (iBox Inspection switch in the INSP position). Check the iBox LCD display to verify that it is on Machine Room Insp.
2. On Machine Room Inspection, run the car down until the car is stopped by the normal limit switch (DNTD). For floor height learning to begin, the ULM signal must be on, DLM must be off, DNTD must be off, and UNTD must be on.
3. Place the iBox Learn switch in the ON position.
4. In iView, display the *Floor Heights Learn* layout by selecting *Floor Heights* from the *View > Layouts* menu and then clicking the *Learn* tab on the *Setup > Floor Heights* tab.
5. On the Setup > Floor Heights > Learn tab, select Manual or Auto learn type. (On Manual, you run the car through the hoistway using the iBox Enable and Up/Down buttons. On Auto, iControl will run the car through the hoistway automatically.)



6. If Not Ready is lighted, perform the instructions shown in the message window.
 - The Ready indicator lights when the car is placed in Inspection mode (with the **Learn** switch ON and the ULM sensor is ON without DLM).
7. When Ready is lighted, click *Learn*. The In Progress indicator lights when the Learn button is clicked.

- If Manual learn type was selected, you are prompted to press and hold the iBox Enable and Up buttons. The elevator will move up the hoistway at Inspection speed.
 - You may click Abort at any time to abort the procedure. If the learn process is aborted, the last saved complete set of values is retained.
8. The procedure is complete when the up normal limit switch (UNTD) is activated (if Manual learn type, you are prompted to release the Enable and Up buttons) and **Done is lighted**.
 9. Set the iBox *Learn* switch to the *OFF* position.
 10. Click the screen refresh button () to update the learned floor height information.
 11. On the Hoistway pane, verify that the learned floor heights appear accurate. Also check the iBox *Safety OK* status. (Occasionally, the Final Limit Switch may open at the end of a Learn run.)

Verifying One Floor Run Operation

The first step in verifying normal, one-floor run operation is to verify proper correction, run, and stopping.

Verifying Correction, Run, and Stop

1. Arrange the elevator for empty car conditions.
2. On the Configuration > Pattern > Common tab, set *Pattern scaling* to 50%. This setting allows the car to run at 50% of the commanded speed.
3. Move the car on Inspection to a location between floors, more than one foot away from a landing so that no leveling sensors are engaged.
4. Place the car in Test mode (iBox Test switch ON). Set the iBox Fault Bypass switch to ON.
5. On the iView Diagnostics > Fault Bypass tab, bypass:
 - Level 1 and Level 2 Overspeed faults
 - UETS/DETS faults
 - Position faults
 - Limit switches checksum
6. Take the car out of Inspection operation (iBox Inspection switch in the NORM position). The car will perform a Terminal Synchronization, using the learned position of the sensor to update the current position reported by the position encoder.

Note

If a Limits Switches Checksum Fault is generated when the car is removed from Inspection operation, it will be necessary to set the terminal switches to default values before proceeding (View > Setup > Terminal Switches tab). Perform the procedure shown in the Terminal Learn message window titled “*To default terminal switches, please do the following:*”.

- If the car corrects and stops properly, proceed to [Initiating a One Floor Run](#) later in this section.

If the Car Does Not Stop and Correct Properly


- Check the iBox status display. Verify:
 - ULM, DLM, and DZ signals are working properly
 - Safety OK = ON - safety string is made up.
 - Doors Locked= ON - all doors are locked.
 - Inspection = OFF - not on Inspection operation.
 - Fault = OFF - no faults are active.

Initiating a One Floor Run



Because we have not yet learned Normal and Emergency Terminal Limit switches, stay away from the terminals to avoid tripping faults. Remember that Fault Bypasses are on a 15-minute limit. If you need more time, set Fault Bypass quickly to OFF, then back to ON (within two seconds).

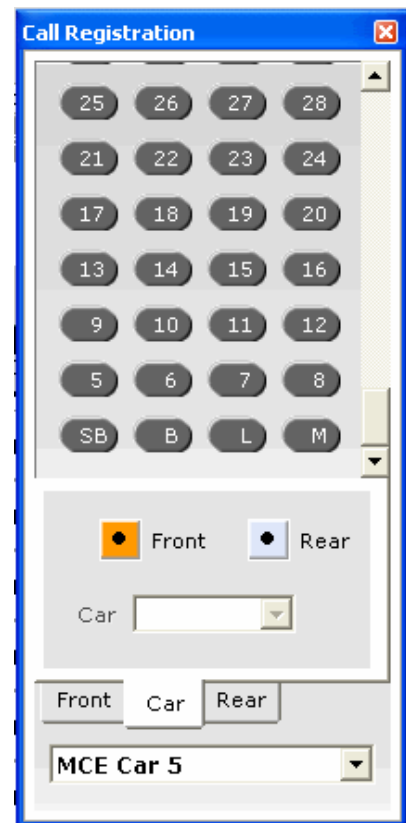
The car should now be at a floor. Avoid running the car close to a terminal landing. To initiate a one-floor run:

- Register a car call one floor above or below the current car position:
 - Click the Car Call Registration button .
 - Select Car Calls, then Front or Rear panel.
 - Click a floor selection button.

If Initiation is not Successful

If the car does not move, check the iBox status display. Verify:

- Safety OK = ON - safety string is made up.
- Doors Locked = ON - all doors are locked.
- Inspection = OFF - the car is not on Inspection operation.
- Faults = OFF - there are no active faults.



Verifying a One Floor Run

During a one-floor run, observe the following:

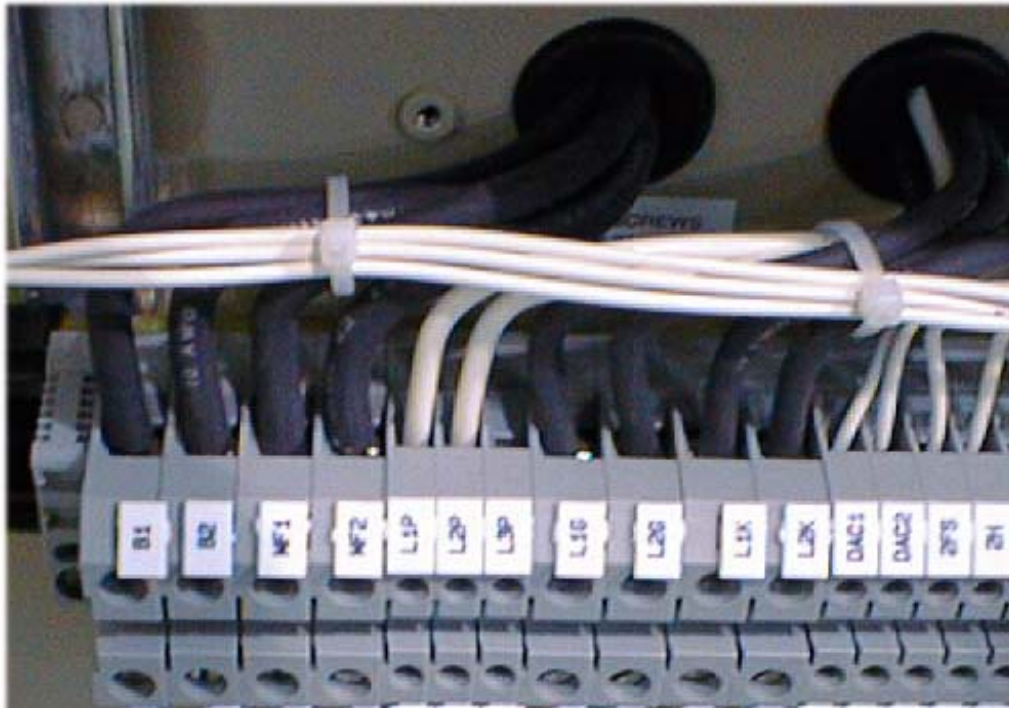
- When the car starts, note that on the Hoistway display, the position indicator changes to the next floor just before reaching the desired floor.
- The car will decelerate to a point 6" (152.4 mm) before the destination floor where the Level Up or Level Down sensor will activate the associated indicator. This can be observed on the Setup > Floor Heights > Learn tab.



- The car will continue until it reaches a point 3" (76.2 mm) before the floor, then the Door Zone input will activate. The Door Zone Rear input will be active if the floor has rear doors.
 - The elevator will continue to level into the floor and stop. The final leveling speed should be set from 2 to 8 fpm (0.01 to 0.04 m/s). Your actual speed will be a fraction of that since Pattern scaling is set to 50% at this time.
1. On the iView Virtual [Oscilloscope](#):
 - Set Test point 1 to Pattern Command
 - Set Test point 2 to Speed Feedback (8-volts equals contract speed)
 2. Run the car between floors to any intermediate landings (avoid activating terminal switches).
 3. Observe that the car starts, accelerates, then decelerates into the floor and stops. If the car overruns a floor, the relevel function will be activated. The Leveling Speed on the first approach to a floor and the Releveling Speed (if releveling is necessary) are two separately programmable values. These values are set on the Configuration > Pattern > Common tab.

Verify Releveling

1. When the car is at a floor, simulate overrunning by temporarily changing the floor height Offset (Configuration > Floor Heights > Floor Offsets tab) to 0.50" and pressing the Send button.
2. Observe the releveling operation. (Return Offset to the proper setting and press Send.)
3. Monitor the brake voltage on terminals B1 to B2 (located just below the iBox). Make sure that a relevel brake voltage exists to avert stalling or excessive current draw by the AC Drive during a relevel operation. Gearless machines are intended to drag the brake during a relevel, so a partial pick is appropriate. Note, however, that if the brake did not drop fully before the relevel, the reduced brake voltage may still hold the brake fully picked.
4. Note that the relevel brake voltage is the same as pick voltage if you are using a low current brake.



Note

Do not spend a lot of time here working on the brake, just be sure the brake does not stall the motor on a relevel. Final brake adjustment is a later topic in this section. (Please refer to “Brake Parameter Adjustments” on page 4-20.)

Reaching Contract Speed

Note

Be sure to read this entire section before performing the following procedure. The car must be on Test operation (iBox Test switch to ON) throughout the setup procedure. This prevents the doors from operating during adjustment.

Final Adjustment Before Running at Contract Speed

The following adjustments must be made in preparation for contract speed operation.

Speed Pick Delay

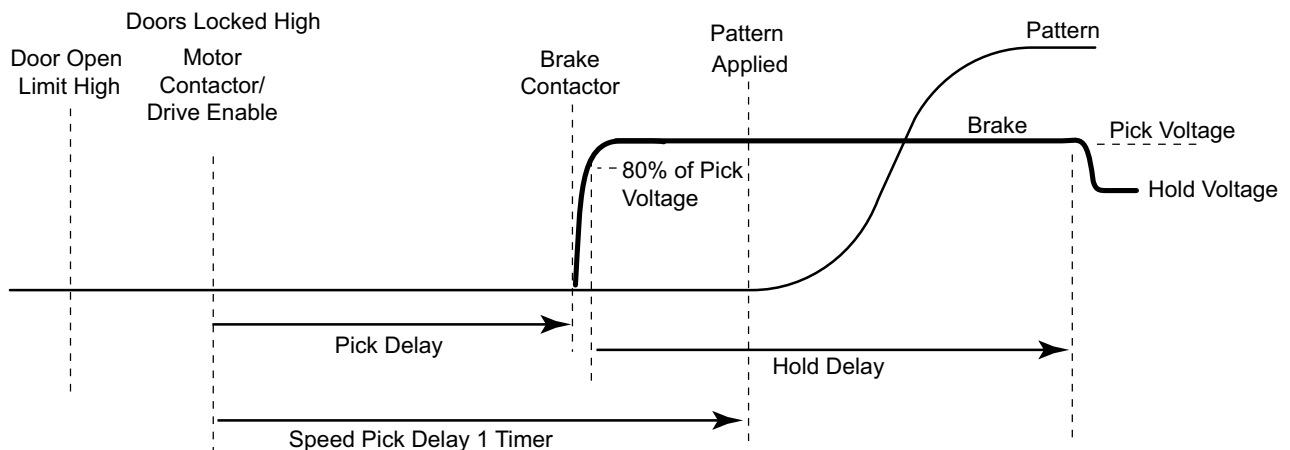
To achieve proper starting, without rollback or snapping away from the floor, a variable delay in the application of the pattern signal is provided. Speed pick delay 1, on the Configuration > Brake > Control tab, determines the amount of delay from the time the drive processor activates the Run Enable signal to the time the pattern generator sends out the pattern signal.

1. The brake should just clear the brake drum as the car is beginning to accelerate. The recommended initial setting for (Brake) *Pick delay* = 0.400 and for *Speed Pick Delay 1* = 0.500. The correct settings can be determined by watching the drive sheave. Some rollback may be tolerated for now, but will be corrected later.
2. If the Drive On Fault (DRO) appears on the iBox LCD display when direction is picked, first increase Pick delay and then increase Speed pick delay 1 to coordinate the application of the pattern signal with the picking of the brake.

Timer	
Pick delay	0.400 sec
Hold delay	2.000 sec
Weakening delay	0.000 sec
Repick time	0.000 sec
Speed pick delay 1	0.500 sec
Speed pick delay 2	0.000 sec
Contactor drop delay	1.100 sec
Brake drop delay	0.000 sec
Voltage decay time	0.000 sec
Relevel drop delay	0.000 sec



Figure 4.1 Timer Diagram



Pattern Scaling

- Using *Pattern scaling* on the Configuration > Pattern > Common tab, increase contract speed in 10% increments until the car is running at 80% of contract speed. Monitor performance on the iView Virtual [Oscilloscope](#). Set:

General		
Position Encoder resolution	256.000	pulses/ft
Pattern scaling	100.000	%
Door pre-opening distance	0.00	in

- Test point 1 to Pattern Command (8V equals contract speed at 100% scaling)
 - Test point 2 to Speed Feedback (8V equals contract speed at 100% scaling)
- Check for severe overshoot by monitoring *Speed/Actual* on the Operational Status tab. Excessive overshoot can trip the governor. If severe overshoot does not occur, continue to increase car speed in 10% increments by increasing *Pattern scaling* incrementally up to a maximum of 100%. Verify that car speed is peaking at no more than 3% over contract speed (10 fpm @ 350 fpm, 15 fpm @ 500 fpm, etc.).
 - If overshoot occurs, reducing *Standard/Low roll jerk* (Configuration > Pattern > Modes tab) may help, however, a Safety A (or B) Contract Overspeed Fault will occur if Standard/Low roll jerk is reduced too much. Increasing the following TORQMAX drive parameters will help to reduce overshoot:
 - A.LF.31 Kp speed accel: Proportional gain
 - d.LF.31 Kp speed decel: Proportional gain
 - Verify car speed by monitoring *Speed/Actual* on the Operational Status tab, or use a hand-held tachometer. If car speed is still not correct, verify the following:
 - LF.11, LF.20, LF.21, LF.22, LF.23, and LF.42 are set correctly.
 - Pattern scaling is 100%.
 - If the car is running faster than contract speed parameter LF.20, decrease the value of high speed parameter LF.42.
 - If the car is running slower than contract speed parameter LF.20, provided LF.42 is set to the same value as LF.20, then verify that Gear Ratio Reduction Parameter LF.22 is set correctly. If the gear ratio is not correct, it is possible to increase the value of LF.22 in small (0.10) increments to reach contract speed.

Speed		
Commanded	0.000	fpm
Actual	0	fpm
Motor	n/a	rpm

Once the car is running at or near contract speed, you must learn the terminal landings in order to **safely** run the car to the terminal landings (required before performing drive fine tuning). (Please refer to “[Learning Normal & Emergency Terminal Limit Switches](#)” on page 4-9.)



Caution

Before learning the terminal switches, you can trip on terminal position and/or velocity faults when the terminal switches (UNT1, DNT1, etc.) are activated. Avoid activating the terminal switches until they have been learned.

Learning Normal & Emergency Terminal Limit Switches

The Normal Terminal Slowdown Limit (NT) and Emergency Terminal Limit (ETS) switch Learn operation records car speed and position at the time each terminal switch is activated on a normal approach to either terminal landing. This Learn operation should be performed again after all parameters have been fully adjusted.

Note

The Terminal Switches Learn procedure must be repeated whenever Pattern profile parameters are modified, since the speed at which the car passes these switches will be different.

To Learn the speeds and positions associated with each NTS and ETS switch:

1. Place the iBox Test switch in the ON position.
2. Place the iBox Inspection switch in the INSP position.
3. In iView, display the Terminal Switches layout (View > Layout > Terminal Switches)

The screenshot displays the iView software interface with three main windows:

- Operational Status - Terminal Switches:** A table showing the position (ft) for various switches. All are set to 2.000.
- Diagnostics - Terminal Switches Status:** A detailed table of switch data including learned values, limits, and last pass speeds.
- Setup - Terminal Switches:** A window for performing the terminal learn procedure, showing a 'Terminal Learn' instruction list and status buttons.

	Position (ft)				Speed (ft/min)			
	Learned	Lower limit	Upper limit	Last pass	Learned	Over speed 1	Over speed 2	Last pass
UNT 5	0.000	-2.000	2.000	0.000	394.00	433.00	454.00	0.00
UNT 4	0.000	-2.000	2.000	0.000	394.00	433.00	454.00	0.00
UNT 3	0.000	-2.000	2.000	0.000	394.00	433.00	454.00	0.00
UNT 2	0.000	-2.000	2.000	0.000	394.00	433.00	454.00	0.00
UETS	0.000	-2.000	2.000	0.000	234.00		951.00	0.00
UNT 1	0.000	-2.000	2.000	0.000	681.00	749.00	786.00	0.00
DNT 1	0.000	-2.000	2.000	0.000	690.00	759.00	796.00	0.00
DETS	0.000	-2.000	2.000	0.000	0.00		951.00	0.00
DNT 2	0.000	-2.000	2.000	0.000	414.00	455.00	477.00	0.00
DNT 3	0.000	-2.000	2.000	0.000	414.00	455.00	477.00	0.00
DNT 4	0.000	-2.000	2.000	0.000	414.00	455.00	477.00	0.00
DNT 5	0.000	-2.000	2.000	0.000	414.00	455.00	477.00	0.00

100 %	0.000 ft	80 %	0.000 ft
95 %	0.000 ft	75 %	0.000 ft
90 %	0.000 ft	50 %	0.000 ft
85 %	0.000 ft	25 %	0.000 ft

4. Refer to the job prints to determine which Normal Terminal Limit switches (UNT_n and DNT_n) are required for this installation and where they should be positioned in the hoistway. Verify that the Learned position on the Diagnostics > Terminal Switches Status tab corresponds to the job prints. If not, refer to the Setup > Terminal Switches tab and perform the procedure titled “To default terminal switches, please do the following:”.
5. Move the car to the bottom landing (on Inspection).
6. Place the iBox Inspection switch in the NORM position to allow the car to synchronize to a floor.
7. Place the iBox Learn switch in the ON position.
8. If the *Not Ready* indicator is lighted (Setup > Terminal Switches tab), perform any instructions shown in the message window.
9. When the *Ready* indicator is lighted, click Learn. The In Progress indicator will light.
10. You may click Abort at any time to abort the procedure. If the learn process is aborted, the last saved complete set of values is retained.
11. Place a call to the top terminal landing using the Call Registration panel.
12. When the car stops at the top landing, place a call to the bottom terminal landing.
13. When the procedure is complete, the Done indicator lights and you are prompted to return the Learn switch to the OFF position. The new NT and ETS switch speeds and positions are automatically saved to the controller.
14. The learned NT and ETS values are displayed on the Diagnostics > Terminal Switches Status tab. Verify that all of the switches required for this job have reasonable values displayed. If only UNT₁ and DNT₁ switches are used in addition to UNT₅ and DNT₅ (always present), the UNT₁ and DNT₁ values must be 95% of contract speed or less. If more NT switches are used, UNT₁ and DNT₁ may have learned speeds equal to contract speed, but all other NT switches must have learned speeds 95% of contract speed or less. If some limit switches have learn speeds in excess of their maximum, those switches must be moved closer to the terminal landings. Alternately, if reduced performance can be tolerated, the Standard/Deceleration parameter can be reduced.
15. Make several full hatch runs. After each run, on the Diagnostics > Terminal Switches Status tab, verify that there is a comfortable margin between the last pass speeds and the Over speed 1 tripping thresholds for the terminal switches used on this job. Also verify that there is a comfortable margin between the last pass positions and the Upper and Lower limit position thresholds.

**Danger**

This procedure must be successfully performed before any passengers are allowed to use the elevator.

Fine Tuning the TORQMAX Drive

This section describes fine adjustments to the TORQMAX drive.

Up/Down High Speed Difference

1. Verify that Pattern Scaling is set to 100%.
2. If car speed, at high speed, is not the same in the up and down directions, verify the following:
 - Drive gain parameters LF.31 and LF.32 are set properly. (If set too high, there may be oscillation in the car.)
 - Pattern voltage between (F4 terminals) X2-14 (Analog IN +) and X2-15 (Analog IN -) or (F5 terminals) X2A-1 and X2A-2 on the TORQMAX drive equals -10.00 VDC in the UP direction and + 10 VDC in the DOWN direction. If the UP/DN pattern voltage is different, perform the adjustments described in Section 2. (Please refer to [“Verifying Car Direction and Motor Control \(TORQMAX\)”](#) on page 2-55.)
3. Use the Actual Speed indication or a hand held tachometer to verify car speed. The elevator should now be running at or near contract speed in both up and down directions.
 - If the elevator is running at a higher speed than parameter LF.20 Contract Speed, decrease the value of parameter LF.42 High Speed.

If the elevator is running at a slower speed than parameter LF.20 Contract Speed, provided LF.42 is set at the same value as LF.20, increase or decrease the value of LF.22 in small increments (0.10) to reach contract speed.

Car Does Not Reach High Speed

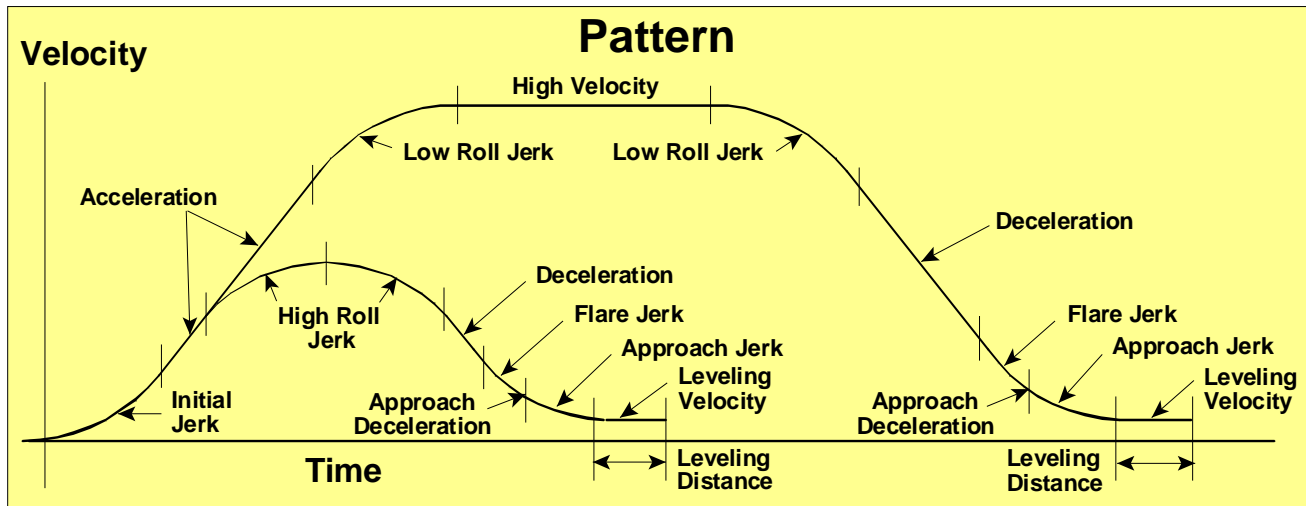
1. Verify that there is +10 VDC between (F4 terminals) X2-14 (Analog IN +) and X2-15 (Analog IN -) or (F5 terminals) X2A-1 and X2A-2 on the TORQMAX drive. If the voltage is not correct, refer to *Up/Down High Speed Difference* above.
2. Verify that the following drive parameters are set correctly:
 - **LF.11** Rated Motor Speed (RPM)
 - **LF.20** Contract Speed (FPM)
 - **LF.21** Traction Sheave Diameter (inches)
 - **LF.22** Gear Reduction Ratio
 - **LF.23** Roping Ratio
 - **LF.42** High Speed (FPM)

Once tuning is complete, relearn the terminal switches. (Please refer to [“Learning Normal & Emergency Terminal Limit Switches”](#) on page 4-9.) Then perform the [Shaping the Speed Profile](#) procedure. (Please refer to [“Shaping the Speed Profile”](#) on page 4-12.)

Shaping the Speed Profile

The pattern graph below charts the profile of car movement between any two landings and calls out the parameters that define profile shape. The value of the pattern parameters is very important in determining the quality of the ride and the overall performance of the elevator. The most critical parameters are Deceleration, Flare Jerk, Approach Deceleration, Approach Jerk and Leveling Speed since they define the final stop and therefore greatly affect the floor to floor travel time. We describe each parameter in sequence and their relationship to problems you may encounter.

Figure 4.2 Pattern Graph



Profile Parameters

- **Initial jerk** - defines the transition from zero speed to full acceleration. As Initial Jerk increases, the profile transitions more quickly from starting to maximum acceleration. Values typically range from 4.0 to 8.0 ft/s³ (1.219 to 2.438 m/s³) with higher values resulting in a sharper start.
- **Acceleration** - determines the maximum acceleration for the profile. Determines the maximum current delivered by the AC Drive during acceleration. The maximum value is typically 4.0 ft/s² (1.219 m/s²) and the minimum is usually not less than 2.5 ft/s² (0.762 m/s²). Values higher than 4.0 ft/s² (1.219 m/s²) are possible but do not yield significant improvements in performance.
- **High roll jerk** - is used on short runs where the car is not able to reach High Speed before deceleration must begin. High Roll Jerk determines how quickly the profile transitions from maximum to zero acceleration and zero to maximum deceleration. As High Roll Jerk increases, the profile transitions more quickly. Lower values provide greater comfort but are harder to fit into the shortest one-floor-runs. We recommend that you identify the shortest full height floor and use it when testing parameter values. Typical values range from a minimum of 4.0 ft/s³ to a maximum of 8.0 ft/s³.

- **Low roll jerk** - is used on runs where the car is able to reach High Speed before deceleration must begin. Low Roll Jerk determines how quickly the profile transitions from maximum to zero acceleration (High Speed) and zero to maximum deceleration. As Low Roll Jerk increases, the profile transitions more quickly. Lower values provide greater comfort. Typical values range from a minimum of 4.0 ft/s^3 to a maximum of 8.0 ft/s^3 .
- **High speed** - determines the maximum speed for this profile. For the Standard Profile this is usually contract speed (ft/min).
- **Deceleration** - determines the maximum deceleration for this profile. The maximum value is typically 4.0 ft/s^2 and the minimum is usually not less than 2.0 ft/s^2 with more common values ranging from 2.75 ft/s^2 to 3.75 ft/s^2 (0.838 to 1.143 m/s^2). The value of Deceleration is usually slightly less than the value of Acceleration (by 0.25 to 0.5).
- **Flare jerk** - defines the transition from maximum deceleration to near zero Speed or to Approach Deceleration. As Flare Jerk increases, the profile transitions more quickly from maximum deceleration to Approach Deceleration. Reduction of this parameter is often used to reduce the tendency to spot or stall near the end of deceleration, and/or to reduce any tendency for the deceleration rate, as experienced in the car, to bunch up (increase as the car approaches the floor). The limiting factor in reducing the value of Flare Jerk is the inability to fit the profile into the shortest normal one-floor-run.
- **Approach deceleration** - determines the deceleration rate for the transition from Flare Jerk to Approach Jerk.
- **Approach jerk** - defines the transition from approach deceleration to Leveling Speed. As Approach Jerk increases, the profile transitions more quickly from Approach Deceleration to Leveling Speed.
- **Leveling speed** - determines the Speed at which the elevator will level into the floor.
- **Leveling distance** - determines the stabilized distance the elevator will travel before arriving at the destination floor.

Profiles

There are eight programmable profiles addressed on the Pattern Screen:

- **Standard Profile** - used under normal operating conditions. Unless otherwise specified, suggested profile parameter adjustments are assumed to be referring to Standard Profile parameters.
- **Earthquake Profile** - used if an earthquake is sensed by the elevator system during normal operation (EQI input activated). If you have earthquake operation, you will verify proper operation during testing.
- **Emergency Power Profile** - used when the Emergency Power input (EPI) is activated, indicating a loss of commercial power and that the car is running on generator power.
- **Emergency Slowdown Profile** - used when the system requires faster than normal deceleration. It is used in response to situations such as the normal terminal stopping device being activated or loss of the quadrature signal (positioning signal). Note that the Emergency rate limited stop parameter (Configuration > Drive > General tab) will limit how fast this profile can slow down the car. Increasing this parameter will allow higher deceleration rates to be used for the Emergency Slowdown Profile.

- **Correction Profile** - used when the system is not confident of the car position in the hoistway. The car proceeds to a known position using the Correction Profile parameters in order to synchronize its position information.
- **Inspection Profile** - used when the system is placed on Inspection/Access operation. The Inspection Profile is also used when the system is learning the building floor heights.
- **Alternate 1** - used when the Alternate Speed Profile One input (ASP1) is activated.
- **Alternate 2** - used when the Alternate Speed Profile Two input (ASP2) is activated.

Setting Pattern Parameters

By viewing the commanded pattern and car speed feedback on the iView Virtual Oscilloscope screen as the car is running, any discontinuity in the idealized speed profile can be observed.

- On the iView Virtual Oscilloscope screen:
 - Set Test point 1 = *Pattern (Command)*
 - Set Test point 2 = *Speed Feedback*

Note

Unless otherwise specified, suggested parameter adjustments are assumed to be referring to Standard Profile parameters.

- **Initial Values for Pattern Parameters** - Pattern shape preset can be used to enter preset values for the Standard profile parameters based on the high speed (contract speed) of the elevator and the selected shape type (Slow, Moderate or Fast). This provides an excellent starting point. [Please refer to “Pattern shape preset” on page 9-132.](#)
- **Contract Speed Overshoot and Current Limiting** -To prevent contract speed overshoot and/or current limiting from the AC Drive, the Acceleration and Low Roll Jerk parameters can be reduced. The Low Roll Jerk rate has a slightly greater effect on overshoot at high speed than does Acceleration. The Acceleration parameter has the most effect on current limiting. Observe actual car response on iBox test point STP2 and GND (with Virtual Oscilloscope Test point 2 set to *Speed Feedback*) to verify that there is no overshoot.
- **Motor Current Limiting** - If running out of motor current near the end of Acceleration becomes a problem, as is evidenced by the AC motor current on the Drive keypad during a full load UP operation:
 - TORQMAX drive - set parameter LF.36 Maximum Torque = 300 (3x LF.17). This will automatically adjust the current limit.
 - If this does not help, reduce the value of Acceleration. Another possibility is to decrease the value of Low Roll Jerk so that there is a smooth transition from maximum acceleration to contract speed. Also verify that sufficient motor voltage is being developed at high speed.

- **Slope of Acceleration / Deceleration** - Ideally, the slope of acceleration in volts per second should be equal to or slightly greater than the slope of deceleration as viewed on an oscilloscope connected to iBox test point STP1 and COM (with Virtual Oscilloscope Test point 1 set to *Speed Feedback Filtered*). To get approximately equal acceleration and deceleration speeds in a system where tracking accuracy is very good, Acceleration can be equal to Deceleration. If tracking is less accurate, set Acceleration greater than Deceleration to get the same effective rate of deceleration as acceleration.

- **Final Approach to the Floor** - Final approach to the floor can be customized in many different ways. If tracking accuracy is very good, you can probably program as follows on the iView Pattern > Common tab:

Leveling	
Leveling speed	4.00 ft/min
Releveling speed	6.00 ft/min
Leveling distance	0.25 in
Releveling distance	0.25 in

- Leveling speed = Your desired leveling speed. A typical number is from 2 to 4.
 - Leveling Distance = your choice. A typical number is from 0.12 to 0.25.
- If tracking is not perfect, you can begin to introduce values in Leveling Speed and Distance that allow you to mold the shape of the last few inches of approach.
- **Excessive Motor Noise** - If there is excessive motor noise or if acceleration or deceleration feels rough, reduce Acceleration and/or Deceleration to provide the desired results. Also, verify that:
 - TORQMAX Drive - At lower speeds the drive automatically selects a lower carrier frequency to produce more current from the drive. If required, adjust LF.38 Switching Frequency = 0. This will set the carrier frequency to 8 KHz. In addition, reduce drive gain value, LF.31 and LF.32. DO NOT reduce LF.31 below 1200 or LF.32 below 800 as a loss of control will result.
 - **Bunching up of Deceleration Rate** - If you are observing a bunching up of deceleration rate (an increase in the deceleration rate as you reach the last few feet of approach to the floor), it is generally due to inaccurate tracking. You must improve accuracy or lower the value of the Flare Jerk and/or Approach Jerk parameters. Remember that there are very real limits to how low you can set these parameters (1.75 ft/s³ is often as low as you can go).

Controlling Initial Start of Car Motion

Some **gearless** machines may exhibit rollback at the start of car motion. Geared machines rarely exhibit rollback. To control rollback at the start of car motion:

- Pre-torque implementation for systems with analog load weighers
- Adjust drive control parameters specifically designed for the start of motion
- Perform a sophisticated brake adjustment (iField Brake Module only)

Pre-torque Adjustments

For installations using an analog load weigher, load information can be used to provide “pre-torquing” of the hoist motor as necessary to accommodate load changes at a floor and prevent sagging or rollback.



Note

Performing safety and buffer tests described later in this section will probably require that you repeat the pre-torque adjustment described here.

Pre-torque adjustment includes:

- Load weigher sensor adjustment
- Balanced load determination
- Pre-torque gain control adjustments

Load Weigher Sensor Adjustment

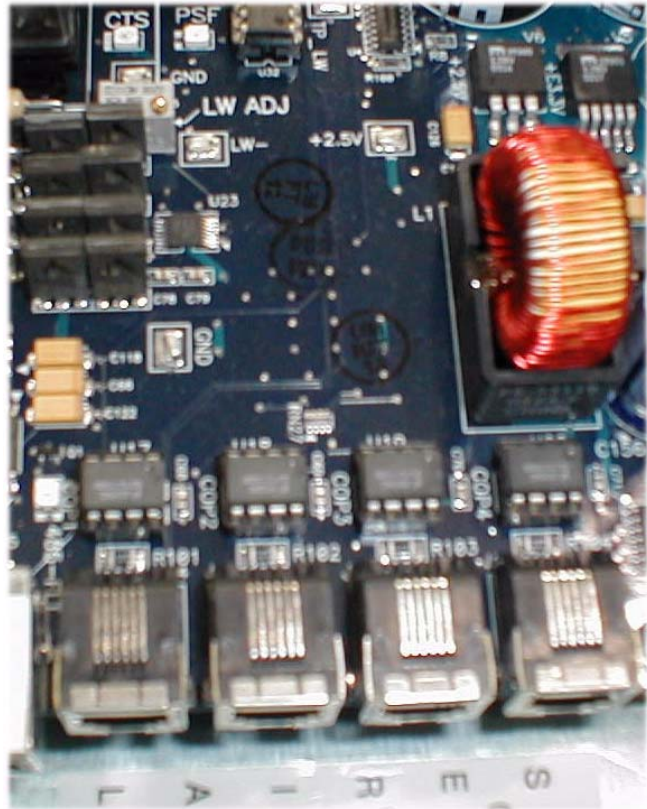
Review the installation and adjustment instructions for the load weigher and verify that all steps have been completed, including:

- Rope Tension Sensing Load Weigher - perform the procedures described in the EMCO Load Weigher section of this manual. [See “Calibration” on page 5-57.](#)
- Crosshead Deflection Load Weigher - perform the procedures described in the “Adjustments” section of the K-Weigh Instruction Manual.
- Isolated Platform Load Weigher - perform the adjustment procedures described in the MCE Load Weigher section of this manual. [See “Adjust the Amplifier” on page 5-68](#)

Next, verify that the iBox is receiving the load weigher signals properly.

1. Place the car on Independent service and move the car to the landing at which the test weights are stored.
2. Open the iView Virtual Oscilloscope screen and select Load Weigher (Raw) on Test point 1.
3. With the car empty, verify that the Test point 1 reading is at least 0.5 but not greater than 1.5.

4. Place a full load in the car. Verify that the Test point 1 value is now between 5.5 and 8.0. If necessary, adjust trimpot LW ADJ on the CTP (cartop) board in the iLink enclosure to achieve the correct reading.



Pretorque Gain Adjustments

1. Place a balanced load in the car (the balanced load weight recorded when performing the Counterweight Balancing procedure). [Please refer to “Counterweight Balancing” on page 3-29.](#)
2. With the car in Test mode (iBox TEST switch ON) move the car to the top floor.
3. On the Configuration > Drive > Pre-Torque tab, enable the Pretorque option and send the new selection to iControl.
4. On the Virtual Oscilloscope, select Load Weigher Balanced on Test point 1. If necessary, adjust the windows so that you can see the oscilloscope and the Pre-Torque parameters at the same time.
5. On the Configuration > Drive > Pre-Torque tab, adjust the *Pretorque balance adjustment* parameter until the digital readout for Test point 1, Load Weigher Balanced, is equal to or as close to zero (0.0) as possible.
6. If *Error compensation*, on the Configuration > Drive > Control tab, was increased to compensate for rollback, you may lower the value now.
7. Verify that *Pretorque position compensation*, on the Drive > Pre-torque tab is set to 0.0. If necessary, set it to 0.0 and *Send* it to the controller.
8. Verify that *Pretorque gain*, on the Drive > Pre-torque tab, is 0.0. If necessary, set it to 0.0 and *Send* it to the controller.
9. On the Configuration > Brake > Control tab, increase the value of *Speed Pick Delay 1* to 2.0 seconds so that any rollback is easily detected.
10. Remove the weights from the car and move the car to one floor below the top landing.

11. Make a one-floor-run down. Check for rollback by either watching the motor or by monitoring the Speed Feedback signal on the Virtual [Oscilloscope](#).
12. If rollback is detected, adjust the *Pretorque gain* parameter on the Drive > Pre-Torque tab, and again make a one-floor run down from one floor below the top landing. Repeat until rollback is no longer noticeable. Then verify that there is no rollback on a one-floor run going up from one floor below the top landing.
13. Run the car to the bottom landing. Make one-floor runs up and then down, checking for rollback.
14. If rollback is detected, decrease the value (less positive or more negative) of *Pretorque position compensation*, on the Drive > Pre-Torque tab. Repeat until no rollback is detected on one-floor runs up or down in the lower hoistway. If pull-through is detected, increase the value (more positive or less negative). Pretorque position compensation has a range of -5.000 to +5.000.
15. With the car empty, check throughout the hoistway and verify that rollback is not detected.
16. Place full load weights in the car and check for rollback throughout the hoistway. Verify that rollback is not detected. Adjust *Pretorque gain*, on the Drive Pre-Torque tab, if necessary.
17. Again remove all weights from the car. Check for rollback throughout the hoistway and verify that no rollback is detected. If some rollback has been introduced by adjusting the Pretorque gain for a full load, optimize the setting for an empty car, since this is the most frequent condition.
18. Reduce *Speed Pick Delay 1*, on the Configuration > Brake > Control tab, to the minimum value which still allows the brake to lift fully before motion starts. You should not feel the car pulling out from under the brake. The brake should lift fully before motion starts, but avoid unnecessary delay in starting movement.

**Note**

If this car will be using the load weigher for dispatching functions, e.g. Light load anti-nuisance, etc., you may want to set the parameters and learn the load values at this time. [Please refer to “Load Weigher Adjustment for Dispatching” on page 4-30.](#)

Drive Control Adjustments

In AC Flux Vector drive applications, when Run Enable (RE) is active, the control system picks the main power contactor (PM Contactor) and enables the drive unit. The drive applies voltage to the AC motor to build up magnetic flux. The amount of time it takes to build up flux in the AC motor (from 200 to 500 ms) depends upon motor characteristics and temperature. AC drive logic detects the build up of flux in the motor and generates the Drive ON output. At this time, the motor may have developed enough torque to hold the load.

The motor no load current value is not high enough to hold the car at zero speed when the drive is enabled. The normal setting for no load current is 30% to 40% of full load current. Pick delay (Configuration > Brake > Control tab) is used to coordinate the picking of the brake with the build up of flux. If the delay is not sufficient, the flux will not build up fully and a DRO fault will occur. Speed pick delay 1 is used to delay the application of the pattern signal to the drive to prevent the car from moving under the brake.

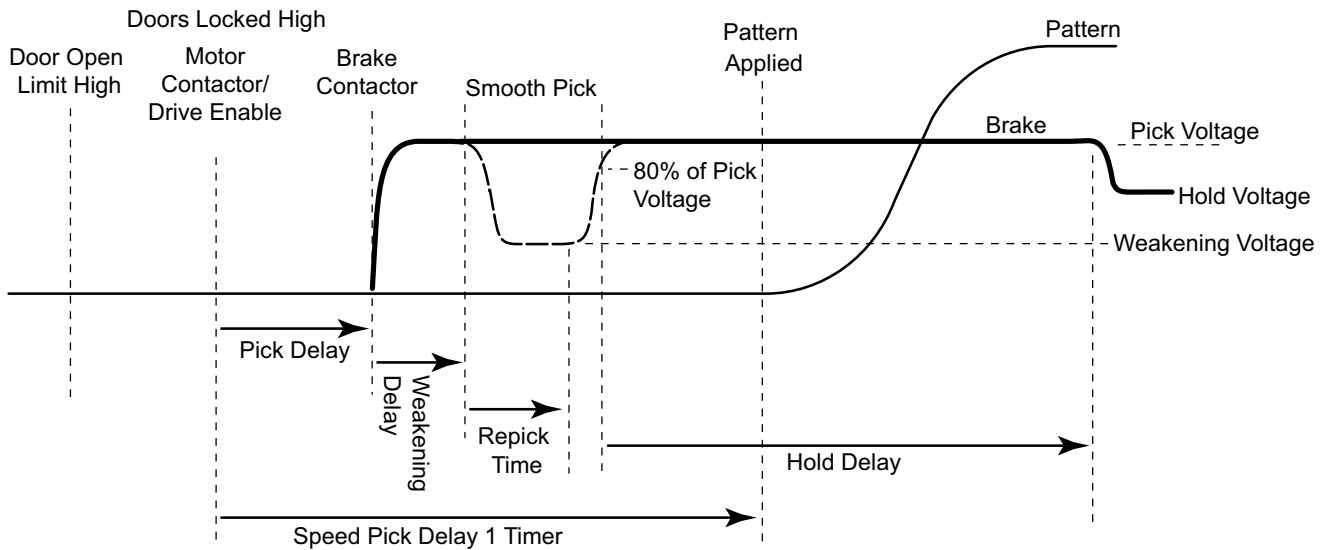
- Pick delay must be adjusted to achieve a smooth start, prevent rollback, and prevent DRO faults.
- Speed pick delay 1 must be adjusted to prevent movement of the car under the brake.

Brake Parameter Adjustments

The iField braking module allows you to make some very refined brake adjustments for smooth picking to control rollback.

- First, find the level of brake excitation that results in a very gradual but *complete* picking of the brake:
 1. Place the car on Inspection (iBox Inspection switch in the INSP position). Set Pattern Scaling (Pattern/Common tab) to 10% to provide an inspection speed of about 5 to 10 fpm.

Figure 4.3 Brake timing diagram for smooth picking



2. Display the Configuration > Brake > Control tab and record the original parameters before making any changes. Verify the following settings:
 - Weakening delay = 0.00
 - Repick time = 0.00
3. Set the Pick voltage and the Hold voltage to $\frac{1}{2}$ of the original value of Pick voltage.
4. Slowly increase both Pick and Hold voltages until the brake picks completely. The idea is to increase or decrease *both* Pick voltage and Hold voltage identically until the brake just barely picks all the way. Then, add 5 or 10 volts and verify that the brake still has a very slow, smooth picking motion (taking 1 to 1.5 seconds to pick). The goal is to find a brake voltage that allows the brake to transition slowly through the pressure-releasing part of the movement.
5. Set the Weakening voltage to the same value as Pick Voltage and Hold Voltage. For geared applications, if the brake holding voltage is not specified, set Weakening voltage and Hold voltage = Pick voltage.

6. Apply a maximum value of brake voltage, very briefly, at the start of movement. This gets the brake quickly to the point in the lifting process where a substantial amount of tension is released. This is done as follows:
 - Set Pick voltage back to the original value to allow a high initial value of brake voltage.
 - Set Repick time to 1.00 second to allow a slow transition through the pressure-releasing part of movement, after which the brake voltage briefly returns to a high value to ensure that the brake fully picks. (See the following note.)
 - Increase the value of Weakening delay in 0.05 second increments until you see the brake move more quickly in the first part of its movement so it can reach the stage where the pressure is starting to be released. Typical values are between 0.10 to 0.45 seconds. The final result will often look as if the brake is lifting at a fairly constant rate, even though the initial voltage is high. This overcomes the natural tendency for a gearless brake to start lifting slowly and then faster the further it lifts.



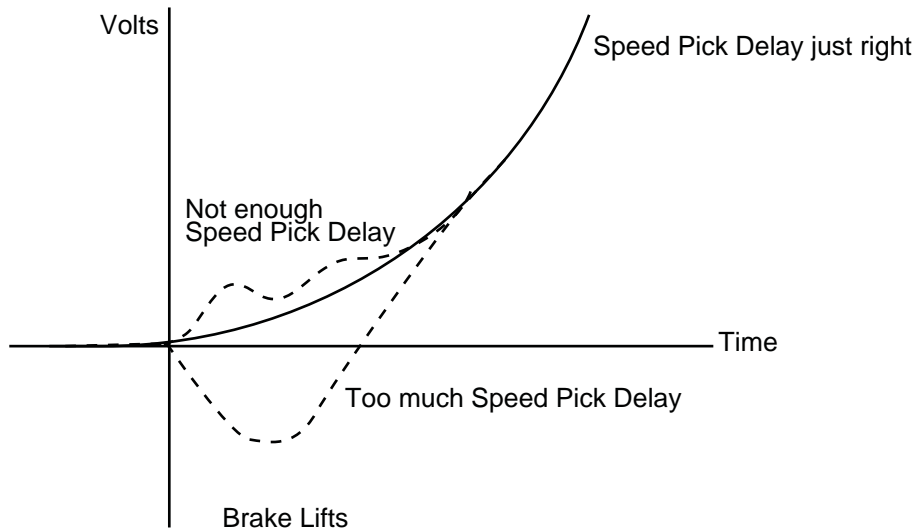
Note

It is important to realize that full brake Pick voltage is *automatically* applied for about a second at the end of the brake Weakening delay, just after the brake has cleared the braking surface, thereby guaranteeing full lifting after a smooth transition through the zone of pressure release. After the brief return to full brake voltage, the brake voltage will *automatically* drop to the Hold voltage, but must not allow the brake to sag back onto the braking surface.

- Verify the manufacturers recommended value for brake holding voltage and set Hold voltage to that value. If this information is not available, experiment with Hold voltage to determine the voltage necessary to hold the brake up, and then add a little extra margin.
7. At this point, a storage oscilloscope is suggested to get the best results from adjustment. Connect the scope to iBox test points STP2 and GND (with the iView Virtual Oscilloscope Test point 2 set to *Speed Feedback*) to view car speed response.
 8. Set the horizontal sweep to about 0.5 to 0.2 second per division and increase vertical gain until you see a microscopic view of the breakaway at the start of movement. A rough start is characterized by jaggedness at the beginning of the curve; a smooth start by a smooth transition from the horizontal line to the acceleration curve. Using this method, you can touch up parameters such as Speed pick delay 1 in the next step.
 9. On the Configuration > Pattern > Common tab, set Pattern scaling to 100%.
 10. Coordinate the start of the car with brake operation by *increasing* Speed pick delay 1 (Configuration > Brake > Control tab) until you begin to see rollback at the start of an empty car DOWN run at the top floor. Then, decrease Speed pick delay 1 until rollback just disappears.

It may be helpful to reduce the Initial jerk parameter to 5.00 or 4.00 to help provide a smooth start. Remember that *any* change in the brake parameters, Initial jerk, or any of the gain parameters relating to the speed loop will probably affect the coordination of the starts. Therefore, you must readjust Speed pick delay 1 after any such changes.

Figure 4.4 Effect of Speed Pick Delay on the Start of Car Motion



Become familiar with the correlation between what is seen on the scope and what is felt in the car at the start of motion. Use the scope to adjust brake parameters to provide smooth starts. If the car has sleeve bearings, be sure to evaluate starts without letting too much time pass between runs to get accurate rollback information. Once you see the effect of the various parameter adjustments on car operation, you will see how important it is to have the brake properly adjusted.

The value of Repick time (Configuration > Brake > Control tab) can be reduced but doing so will reduce the time that the brake spends accomplishing a slow lift with Weakening voltage applied. This will eventually cause the brake to start lifting rapidly. Typically, Repick delay should not be less than 0.50 seconds.

Calibrating the Floor Offsets

iControl provides an easy and precise method of setting the parameters required to stop the car accurately at every floor. Stopping “spot on” at every floor requires three things:

1. The control system must know the exact position of the car in the hoistway and the exact position of each landing target (magnet). Without requiring any user adjustment, the extremely accurate iLand landing system allows iControl to know the car’s position in the hoistway to within 1/20 inch. And the Floor Height Learn procedure, [see “Learning the Floor Heights” on page 4-2](#), allows iControl to know the exact position of the landing target to the same accuracy.
2. The control system must know the exact position in the hoistway of each landing sill. Calibrating the floor offsets allows iControl to know this position to an accuracy limited only by the accuracy of your measurement.
3. The car must be adjusted to stop smoothly and consistently, given the limitations of controlling the machine and brake and the inevitable trade off between stopping accuracy and ride quality. These adjustments will be performed after the floor offsets are calibrated. [Please refer to “Adjusting Leveling and Final Stop” on page 4-26](#).

Floor offset calibration procedure

This procedure requires IMP software version 002.001.001 or greater and iView software version 003.000.001 or greater.

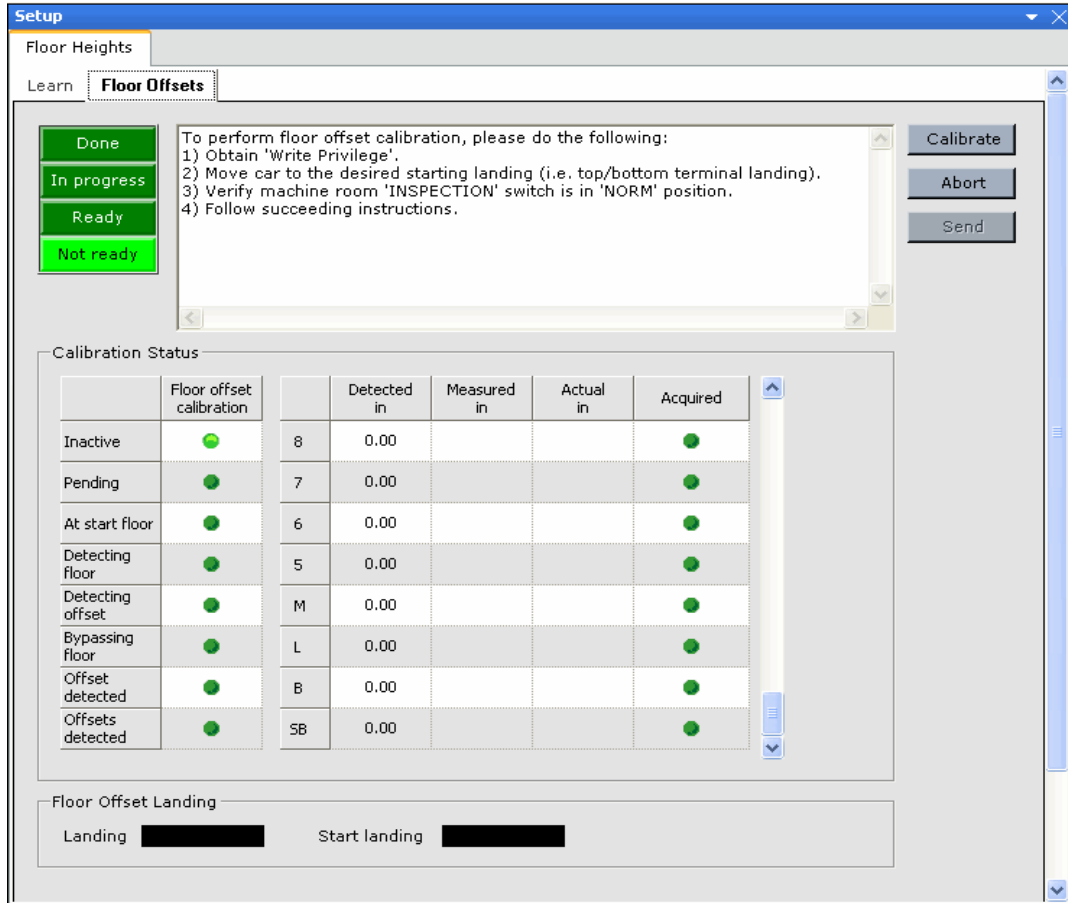
Floor offset calibration can be performed by one or two persons. You will move the car to each floor that you want to calibrate, and the distance between the car sill and landing sill must be measured. You can use the form provided to record your measurements ([See “Floor Offset Calibration Record” on page 4-25](#)). You need not perform the calibration for all floors each time the procedure is performed.

The measured values, in decimal inches, will be entered into iView on the Setup > Floor Heights > Floor Offsets tab). You can make the measurement using a fractional inch square and then use the conversion table provided to determine the decimal value. But the better way is to use a machinist square which is marked in decimal inches.

Once the floor offsets have been entered, iControl is able to calculate the exact location of each hoistway landing sill using the known exact position of the car, known exact position of the target magnet and the measured distance from the car sill to the hoistway sill. Then, once the car is adjusted to stop smoothly and consistently, iControl can stop the car “spot on” at every landing.

To calibrate the floor offsets:

1. Display the Floor Offsets Setup tab by selecting *Floor Heights* from the *View > Layouts menu* and then clicking the *Setup > Floor Offsets* tab.



2. Move the car to the desired starting landing (e.g. top or bottom terminal landing). The *Ready* indicator should light. Follow the instructions provided in the text box.
3. Verify that the machine room *INSPECTION* switch is in the *NORM* position. It is recommended to place the car on *Independent service* while performing this calibration.
4. Click *Calibrate* to begin making offset measurements. The *In progress* indicator lights.
5. Run the car to each floor where you want to calibrate the floor offset and perform step #6. It is not necessary to calibrate all floors each time this procedure is performed.
6. Upon arrival at each floor, wait about 10 seconds to allow the car to settle and for iControl to acquire the car's exact position (*Acquired* light turns on). Measure and record the distance the car sill is above or below the hoistway landing sill, and record the direction (car sill above or below). If the sills are not parallel, record the average measurement.
7. Return to the starting floor and measure its offset last. The *Done* indicator lights indicating that the measurement portion of the offset calibration procedure is completed.
8. Enter the measured value (decimal inches) in the *Measured in* column (Offsets table on the Setup> Floor Heights > Floor Offsets tab). If the car sill was above the landing sill, enter a plus (+) value. If the car sill was below the landing sill, enter a minus (-) value.
9. Click *Send* to send the new offset values to the iController

Table 4.1 Floor Offset Calibration Record

Floor	Car Above/ below landing	Fractional inch	Decimal inch	Floor	Car Above/ below landing	Fractional inch	Decimal inch
30				60			
29				59			
28				58			
27				57			
26				56			
25				55			
24				54			
23				53			
22				52			
21				51			
20				50			
19				49			
18				48			
17				47			
16				46			
15				45			
14				44			
13				43			
12				42			
11				41			
10				40			
9				39			
8				38			
7				37			
6				36			
5				35			
4				34			
3				33			
2				32			
1				31			

Table 4.2 Fractional inch to decimal inch conversion

Fractional in.	Decimal in.	Fractional in.	Decimal in.
1/32	.031	9/32	.281
1/16	.063	5/16	.313
3/32	.094	11/32	.344
1/8	.125	3/8	.375
5/32	.156	13/32	.406
3/16	.188	7/16	.438
7/32	.219	15/32	.469
1/4	.250	1/2	.500

Adjusting Leveling and Final Stop

This section describes adjusting leveling into the floor and bringing the car to a final stop.

Final Approach and Leveling

Observe elevator operation by watching the hoist motor and observing car response on iBox test point STP1 to GND (with the Virtual Oscilloscope Test point 1 parameter = *Speed Feedback*).

- If tracking accuracy is very good, increase Leveling speed and decrease Leveling distance to reduce floor-to-floor time. You can also increase the value of Approach jerk, Deceleration, and Flare jerk.
- If tracking is not perfect, begin to reduce Deceleration, Approach jerk, and Flare jerk parameters to mold the shape of the last few inches of approach. Some experimentation will be necessary in order to see the effect of changing parameter values. A digital storage oscilloscope is essential.
- The goal is for the speed pattern shape to flare out and blend the deceleration into the leveling speed. It is possible to modify the pattern to obtain a lot of stabilized leveling or to decelerate the elevator all the way into the floor to obtain the best brake-to-brake times. It is here that most of the performance and perceived ride quality is determined. Try the full load range to be sure the stops are consistent.

Final Stop

There are many items to consider in establishing a smooth and accurate stop. Each contributes to the final result:

- **Brake drop delay** - First adjust Brake drop delay on the Configuration > Brake > Control tab to provide too much delay in dropping the brake so you can clearly see the complete electrical stopping characteristics of the hoist motor. Keep these characteristics in mind as adjustments are made. It may be necessary to change Brake drop delay more than once to clearly see the results. It is most important to never drop the brake on a moving motor.
- **Normal rate limited stop** - Adjusting Normal rate limited stop (Configuration > Drive > General tab) will also determine how harshly the stop is felt (higher values yield harsher stops). Lower values may require a larger dead zone. To prevent the car from pulling through under the brake, do NOT set this parameter to 0.0.
- **Voltage decay time** - Adjusting Voltage decay time (Configuration > Brake > Voltages tab) determines how softly the brake drops (higher values yield softer drop). If Voltage decay time is set too high, there will be loss of control during the time between the drive “disconnecting” and the brake setting firmly.
- **Brake Release Time** - The TORQMAX drive has an adjustable parameter (LF.70 Speed Pick Delay) that determines how long the drive will keep current flowing to the motor when the car reaches zero speed and the direction input is removed. This allows the motor to hold the load while the brake engages. The normal setting for LF.70 is 0.300 second, but it should always be kept below 0.800 second.

- **Leveling Speed** - If this speed is too high, a quick transition to zero speed will occur. This results in a bump at the stop or possible overshoot at the floor resulting in a releveling operation. If the leveling speed is too slow, the car will stop very close to the edge of the dead zone, which will cause the system to relevel frequently. Reasonable values of Leveling speed (Configuration > Pattern > Common tab) range from 3 to 6 fpm. Before setting the Dead zone distance, the selection of Leveling speed must be completed so that you are satisfied with the complete final approach to the floor. If overshoot occurs frequently, adjust Dead zone distance.
- **Dead zone** - The purpose of the dead zone is to ensure that the elevator stops at the same point whether approaching a particular floor from above or below. The dead zone is a software-defined area at a floor, typically 0.25 inches (6 mm) to 0.75 inches (18 mm) in height. Ideally, the elevator stops in the *center* of the dead zone.

Because of the mass of the elevator system, it will not stop as soon as it is commanded to stop. It will slide slightly before stopping. The Dead zone distance should be adjusted so that the elevator stops consistently at the same position relative to the floor level from both directions. Dead zone adjustment need only be adjusted for one floor. All other floors will react in the same way.



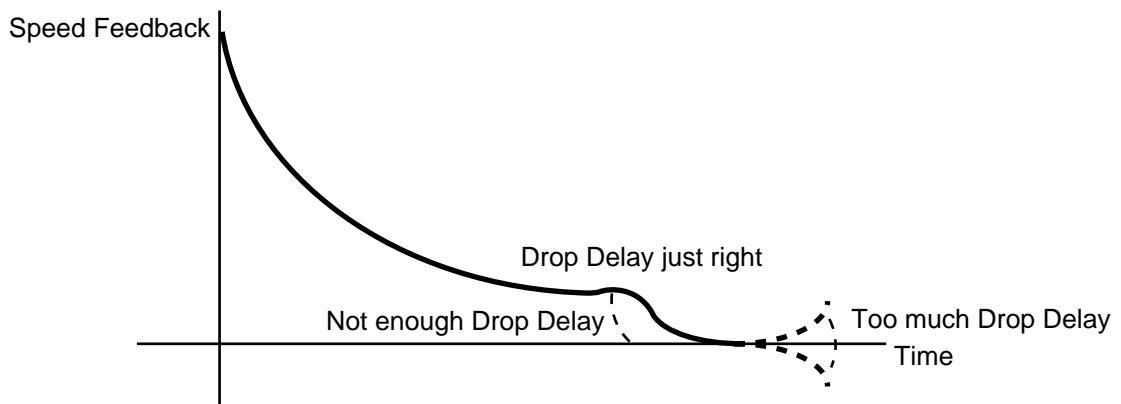
Note

Dead zone distance should be adjusted before fine tuning floor height offset.

1. Choose a floor in the middle of the hoistway so that the car can reach contract speed when approaching the floor from either direction.
2. Start with the default Dead zone distance (Configuration > Pattern > General tab).
3. Put the car on Test operation. Verify that the iBox Inspection switch is in the NORM position. Verify that the iBox Test switch is in the ON position.
4. Run the car to the chosen floor from the top and make sure the car achieves contract speed. Note the position of the car when it stops at the floor (i.e., 1/4" above the floor or 1/8" below the floor, etc.).
5. Run the car to the chosen floor from the bottom and make sure the car achieves contract speed. Note the position of the car when it stops at the floor.
6. If the car consistently stops at the same position, (for example, 1/8" above the floor approaching from above or below), then Dead zone distance is properly adjusted. (Floor Offset can be adjusted later so that the car stops perfectly level with the floor.)
7. If the car overshoots and relevels, the Dead zone distance is too tight. Increase Dead zone distance and repeat steps 4 and 5.
8. Otherwise, the Dead zone distance is too wide. Decrease Dead zone distance until the car stops consistently at the same position relative to the floor, repeating steps 4 and 5.

- **Brake Coordination for Smooth Stops** - Proper operation and setting of the brake is very important to achieve a smooth stop:
 1. Before starting, the brake must be operating properly. Geared machine brakes are usually very simple, however, the brake on a gearless machine requires detailed adjustment to obtain proper operation. For now, be sure to adjust brake tension to hold 125% of a rated load (or the value required by your local code authorities). To establish a holding voltage for a brake in a geared installation, refer to the manufacturers recommended value. If this information is not available, experiment with the Hold Voltage (Brake Configuration/Voltage tab) to find the voltage necessary to hold the brake and then add a little extra margin.
 2. If you have already adjusted the brake to the correct mechanical clearances and the brake is still clunking down too hard when the car stops, increase Voltage Decay Time (Configuration > Brake > Control tab (iField module, high current braking only). For low current brakes, decrease the RB resistance inside the iPower Box.
 3. Next, adjust **Drop Delay** (Configuration > Brake > Control tab) so that the brake drops the instant hoist motor motion stops. The primary means of coordinating brake drop with motion stop is adjusting Brake Drop Delay. The initial setting should be 0.00 seconds. Increase Drop Delay in increments of 0.10 second until the motor is clearly at zero speed when the brake drops. The goal is to avoid dropping the brake on a moving motor, but also to avoid holding the brake up longer than necessary.
 - TORQMAX drive - Adjust LF.79 Delay in turning off the drive (delay to turn off the motor current after direction is dropped), which can hold the car electrically until the brake is dropped.
 4. Adjust Voltage Decay Time to determine how softly the brake drops (higher values yield softer drop). If Voltage Decay Time is set too high, there will be loss of control during the time between the drive “disconnecting” and the brake setting firmly.

Figure 4.5 Effect of Brake Drop Delay on Stopping



Releveling Operation

- **Relevel Dead Zone Distance** — The Relevel dead zone distance is similar to Dead zone distance except that the Relevel dead zone distance applies only while the car is releveling. During releveling, the brake is partially set and the speed is very slow (usually 4 to 8 feet per minute). Therefore, the car does not slide as much. As a result, Relevel dead zone distance should be tighter than Dead zone distance. Relevel Dead Zone adjustment need only be adjusted for one floor. All other floors will react in the same way. Brake Relevel Voltage (Brake Configuration/Voltages tab) should be adjusted properly before adjusting the Relevel dead zone distance. In general, Relevel Dead Zone must be less than Relevel Distance.
 1. Put the car on Test operation. Verify that the iBox Inspection switch is in the NORM position. Verify that the iBox Test switch is in the ON position.
 2. Move the car to a floor away from the terminal landing to allow releveling to the floor from both directions.
 3. Put the car on Inspection Access.
 4. On Inspection Access, move the car up about 3" above the floor. Turn off Inspection Access to allow the car to relevel down to the floor. Note the position of the car when it stops at the floor (i.e., 1/4" above the floor or 1/8" below the floor, etc.).
 5. On Inspection Access, move the car down about 3" below the floor. Turn off Inspection Access to allow the car to relevel up to the floor. Note the position of the car when it stops at the floor (i.e., 1/4" above the floor or 1/8" below the floor, etc.).
 6. If the car consistently stops at the same position, (for example, 1/8" above the floor approaching from above or below), then Relevel dead zone distance is properly adjusted. (Floor Offset can be adjusted later so that the car stops perfectly level with the floor.)
 7. If the car overshoots the floor during releveling, the Relevel dead zone distance is too tight. Increase Relevel dead zone distance and repeat steps 4 and 5.
 8. Otherwise, the Relevel dead zone distance is too wide. Decrease Relevel dead zone distance until the car stops consistently at the same position relative to the floor, repeating steps 4 and 5.
- **Rope Stretch Releveling** — On high-rise applications, when the car is very low in the building with hundreds of feet of cable between the machine and the elevator, substantial movement can occur when the elevator load changes, thereby causing releveling. To make the system more tolerant of this movement, the Releveling distance parameter adjusts the amount by which the elevator must be away from the floor before the releveling operation is engaged. The range of adjustment is from 0.00 to 1.00 inch, with a typical value being 0.72 inches.

Ride Quality

If you are experiencing a ride sensation that is not exactly an oscillation, but might be described as a rough texture, it might be due to:

- On the TORQMAX drive, parameter A.LF.33 - Ki speed offset accel and d.LF.33 Ki speed offset decel are used to provide a smoother transfer of the load from brake to motor, especially with high efficiency gears. The default setting is 3000 for accel and 1000 for decel. Increase in increments of 1000.
- The encoder, attached to the motor shaft, may not be mounted securely, which may cause bouncing or a slight variation in the speed feedback signal once every revolution. On a geared machine, the coupling used between the tach or encoder and the motor can also be a source of vibration. In both cases, the problem is observed by looking at the AC-coupled encoder speed signal on iBox test point STP2 (with the Virtual Oscilloscope Test point 2 set to *Speed Feedback*). You may see the vibration frequency increase and decrease with car speed. This is *absolute* proof of a mechanical problem with the speed transducer. Electrically induced oscillations will be characterized by a frequency of oscillation that is constant (does not change significantly with speed).
- If the above steps do not resolve the vibration, the motor may not have been trimmed to the machine properly. Use a dial indicator to check alignment of motor and machine.

Load Weigher Adjustment for Dispatching

Analog load weighers (isolated platform or crosshead deflection) provide a signal (analog voltage) corresponding to the measured load. The signal is conditioned, sampled and digitized by the control system. The resulting value is used to calculate the actual load *inside* the elevator, which is used for logical operations including:

- Overloaded car detection
- Heavy load (hall call bypass)
- Light load anti-nuisance
- Empty load detection

Each threshold is user-programmable (Load Weigher Configuration screen) to determine the load level at which each operation should be initiated.

The car is weighed only when it is stopped at a landing with doors open. (This is the only time to anticipate a change in load.) Additionally, if the car were weighed when running, acceleration and deceleration would be interpreted as weight change.

Rope Tension Load Weigher - Load cells sense the tension of the wire ropes. The load weigher provides a calibrated analog signal that accurately tracks the loading of the car. Due to the dynamics of the elevator system, the load represented by the traveling cable and compensation cables will vary with the position of the car in the hoistway. iControl must learn the empty and full car load value at each floor. The load in the car can then be determined by reading the value at a given floor and subtracting the learned empty value for that floor.

Crosshead Deflection Load Weigher - The signal generated by the load sensor represents the perceived load *at the crosshead*, which includes the weight of the car, the load inside the car, the traveling cable, and any compensation cables that might be attached to the car. Due to the dynamics of the elevator system, the load represented by the traveling cable and compensa-

tion cables will vary with the position of the car in the hoistway. iControl must learn the empty and full car load value at each floor. The load in the car can then be determined by reading the value at a given floor and subtracting the learned empty value for that floor.

Isolated Platform Load Weigher - The isolated platform load weigher measures only the weight within the car. The value is not affected by hoistway position so empty and full values can be learned without moving the car from floor to floor.

Note: If you are preparing to do safety testing, including governor and buffer tests, you might want to do them first, then adjust the load weigher because recalibrating the load weigher is recommended following buffer safety tests.

Load Thresholds The load thresholds used in logical operations are:

- **Over load threshold (% of full load):** Used to define the load at which it is unsafe to move the elevator (iView Configuration > Load Weigher tab). If this threshold is exceeded, the car will remain at the floor with doors open. Typically some type of visual and/or audible indicator is used to alert passengers that the car is overloaded. (This operation is overridden during Fire Service operation.)
- **Heavy load threshold (% of full load):** Used to define the load value at which hall calls will be bypassed or reassigned (iView Configuration > Load Weigher tab).
- **Light load threshold (% of full load):** Used to define the load at which a limited number of car calls may be registered. If the programmed number of car calls is exceeded, all car calls will be canceled.

Example: Light Load Threshold=20%. If the measured load in the car is less than 20%, the controller will only allow a certain number of car calls to be registered (number of calls is set on the iView Configuration > Car Operation > Passenger tab/Anti-Nuisance controls shown below). If the allowed car value is set to three, only three calls may be registered if the load is less than 20%. If a fourth call is entered, all car calls will be canceled.

Operational Status | Car Operation

Passenger

- Doors
- Devices
- Passenger
 - Door operation
 - Front
 - Rear
 - Fire service
 - Fire code
 - Independent service
 - Elevator recall
 - Earthquake
 - FMS

General

Lobby floor: 1A

Egress floor: 2A

Nudging

Stop doors due to reopening device activated during nudging

Allow hall buttons to reverse doors on a departing car

Anti-nuisance

Photo eye

Allowed number of call stops without photo eye activation: 0

Light load

Number of car calls allowed: 0

Cancel car calls behind car

Cancel remaining car calls with direction reversal

- **Empty load threshold (% of full load):** Used to determine when the car is empty. If the load falls below the threshold the car is considered to be empty. This can be used for CFSS (Commandeer for Special Services) calls where it is desired that the commandeered car be empty. [Please refer to “Car Operation - CFSS Tab” on page 9-73.](#)

Note: Setting a threshold value to 00% will disable the corresponding function (anti-nuisance, hall call bypass or overload). Example: setting the Heavy Load Threshold to 00% will disable the hall call bypass function.

Load weighing logical functions such as Anti-Nuisance, Heavy Load, and Overload will be inactive until both the full and empty load values have been learned and saved.

Load Weigher Configuration

Once the load weigher is installed, you need to “tell” iControl what kind of load weigher you are using and set up some basic load threshold values and learn the load values. You do this using iView.

Load Weigher Selection and Threshold Settings

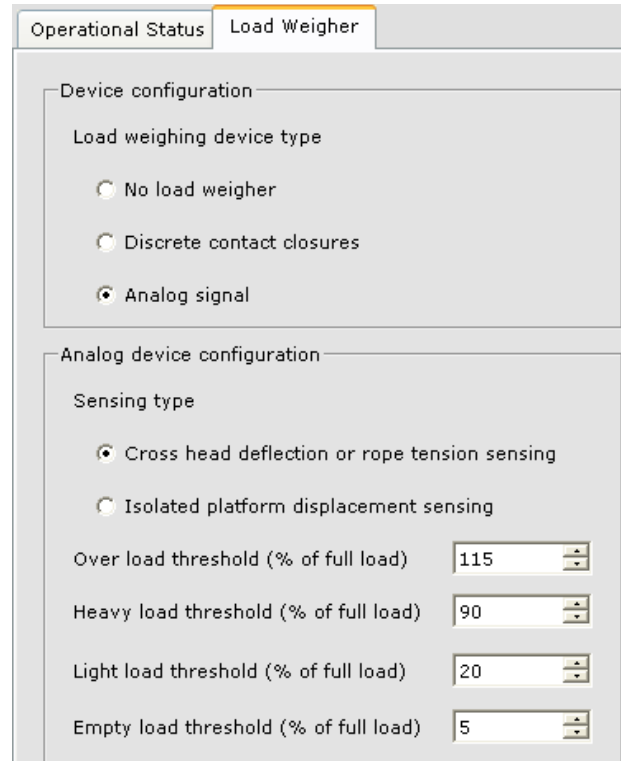
1. Connect to iControl using the iView application.
2. Go to the Configuration > Load Weigher tab.

Device configuration

3. Select the load weigher device type:
 - No load weigher: Select if no load weigher is used.
 - Discrete contact closure: Select if a discrete contact closure weigher is used
 - Analog Signal: Select if an analog signal load weigher is used (rope tension, isolated platform or cross-head deflection load weigher).

Analog device configuration

4. Sensing type: Select the analog device sensing type:
 - Cross head deflection or rope tension sensing.
 - Isolated platform displacement sensing.



Configuration Section	Option / Label	Value
Device configuration	No load weigher	<input type="radio"/>
	Discrete contact closures	<input type="radio"/>
	Analog signal	<input checked="" type="radio"/>
Analog device configuration	Sensing type	
	Cross head deflection or rope tension sensing	<input checked="" type="radio"/>
	Isolated platform displacement sensing	<input type="radio"/>
	Over load threshold (% of full load)	115
	Heavy load threshold (% of full load)	90
Light load threshold (% of full load)	20	
Empty load threshold (% of full load)	5	

Setting the load thresholds

5. Load thresholds are preset by MCE based on the job specification. However, thresholds are user-adjustable and may be changed at any time. All threshold values are expressed as a percentage of full load. To adjust these thresholds:
 - Over load threshold (% of full load): Enter the percentage of full load weight above which the controller should consider the car to be in an over load condition. Typically 110% to 115% of the elevators full load capacity. A setting of 00% = OFF. See [“Load Thresholds” on page 4-31](#).
 - Heavy load threshold (% of full load): Enter the percentage of full load weight above which the controller should consider the car to be in a heavy load condition. Typically 80% to 90% of full load. A setting of 00% = OFF. See [“Load Thresholds” on page 4-31](#).

- Light load threshold (% of full load): Enter the percentage of full load weight below which the controller should consider the car to be in a light load condition. Typically set below 20% of full load. A setting of 00% = OFF. See [“Load Thresholds” on page 4-31](#).
- Empty load threshold (% of full load): Enter the percentage of full load weight below which the controller should consider the car to be empty. See [“Load Thresholds” on page 4-31](#).
- When ready, press the SEND button to send the changed values to the controller.

Learning Load Values

Learning the empty and fully loaded car values is an automated process requiring that the appropriate load be present in the car before beginning each stage. It is best to have two people available, one in the machine room at the elevator controller or iView PC and one at a floor to handle test weights and ensure there are no passengers in the elevator.

The test weights must be equal to full load value. The learn process must be performed twice, once for empty car load and once for full car load. In order to learn load weigher values, the elevator must be in normal Passenger operation. The car will not be moved from the starting floor if the load weigher is an “isolated platform displacement sensing” type. However, if the load weigher is the “rope tensions sensing” or “cross-head deflection sensing” type, the car must travel the hoistway, stopping to learn the load values at each floor.

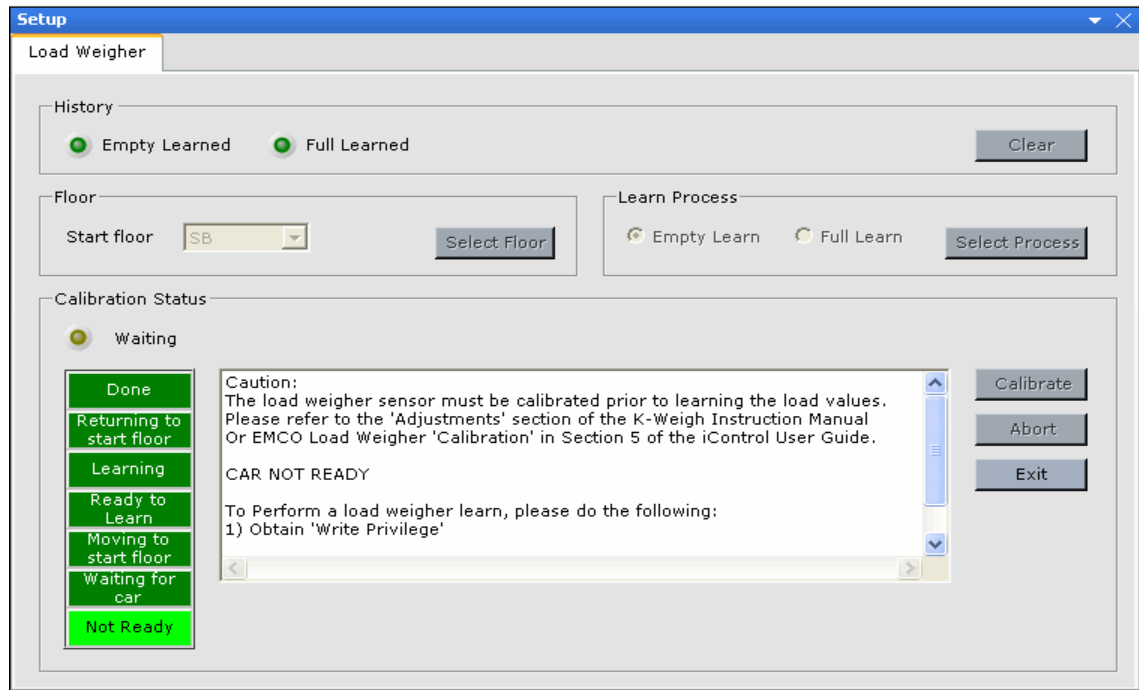


Caution

The load weigher sensor must be calibrated prior learning the load values. [Please refer to “Load Weigher Sensor Adjustment” on page 4-16](#). If you are preparing to do safety testing, including governor and buffer tests, you might want to do them first and then adjust the load weigher sensor and learn the load values, because re-calibrating the load weigher is recommended following buffer tests.

Load Weigher Learn Procedure

1. Display the Load Weigher layout (View > Layouts > Load Weigher).
2. Enter the Start floor (floor at which the test weights are located) on the Setup > Load weigher tab.
3. Acquire “Write privilege” (Write privilege > Acquire) and place the iBox Learn switch in the ON position.
4. With the car operating in normal Passenger operation, follow the step-by-step instructions that appear on the Setup > Load weigher tab.



Abort Calibration If necessary during a learning process, click on Abort to immediately stop the learning process. (For example, you started a Full Load learn and realized the test weights were not in the elevator.) The car will return to the start floor where you may restart the learn procedure.

Clear Learned Values Lighted Empty and Full Learn indicators mean that the processes have been successfully run and values stored. Clicking on the Clear button will immediately erase the stored values. You must then repeat the learning process to learn and store new values.

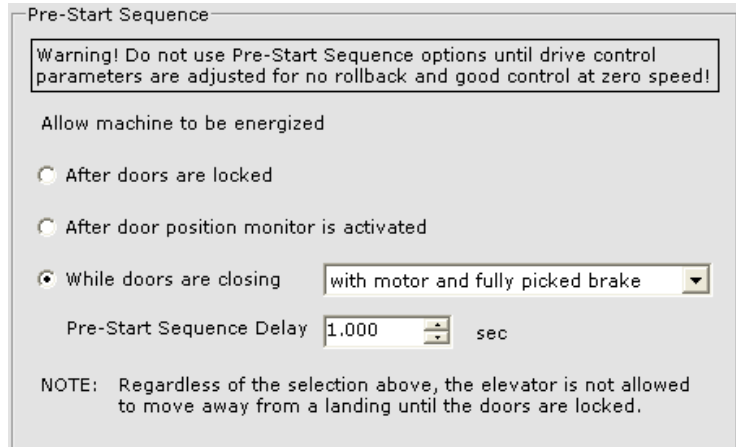
Pre-Start Sequence

If the car is properly adjusted and running well, but the floor to floor times are not as quick as you would like, the Pre-Start Sequence parameters (Configuration > Drive > General tab) can be used to allow the brake and/or motor to be energized while the doors are closing, thereby allowing the elevator to leave the floor as soon after the doors are locked as possible.

The Pre-Start Sequence options include:

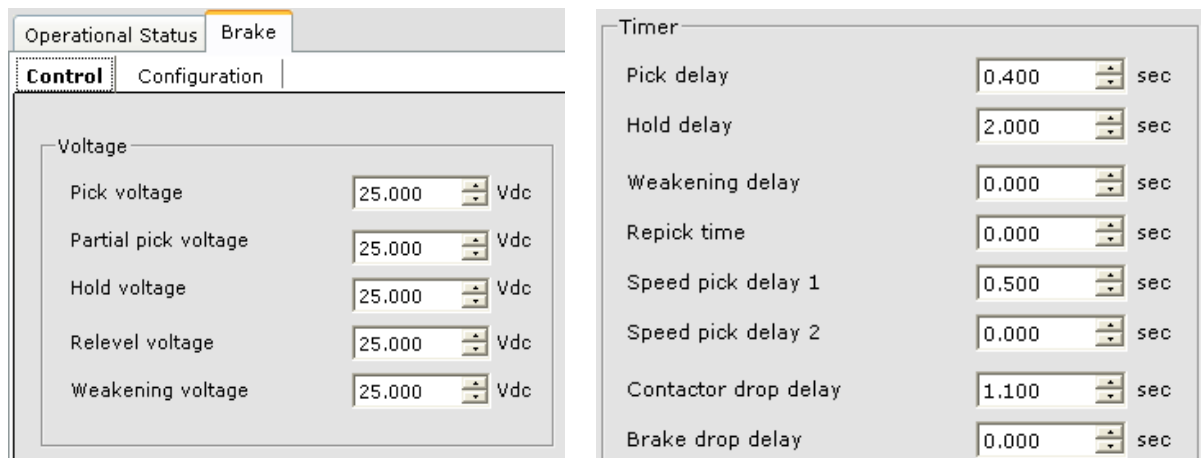
“Allow machine to be energized”

- After doors are locked
- After door position monitor is activated
- While doors are closing:
 - with motor only
 - with motor and partially picked brake
 - with motor and fully picked brake



Regardless of the option chosen, the elevator is not allowed to move before the doors are locked and the Speed pick delay 1 timer has elapsed.

The parameters that affect the Pre-Start Sequence options are found on the Configuration > Brake > Control tab.



The following pages include descriptions of each Pre-Start Sequence option and diagrams showing the parameters that affect each option and the resulting sequence of operation.



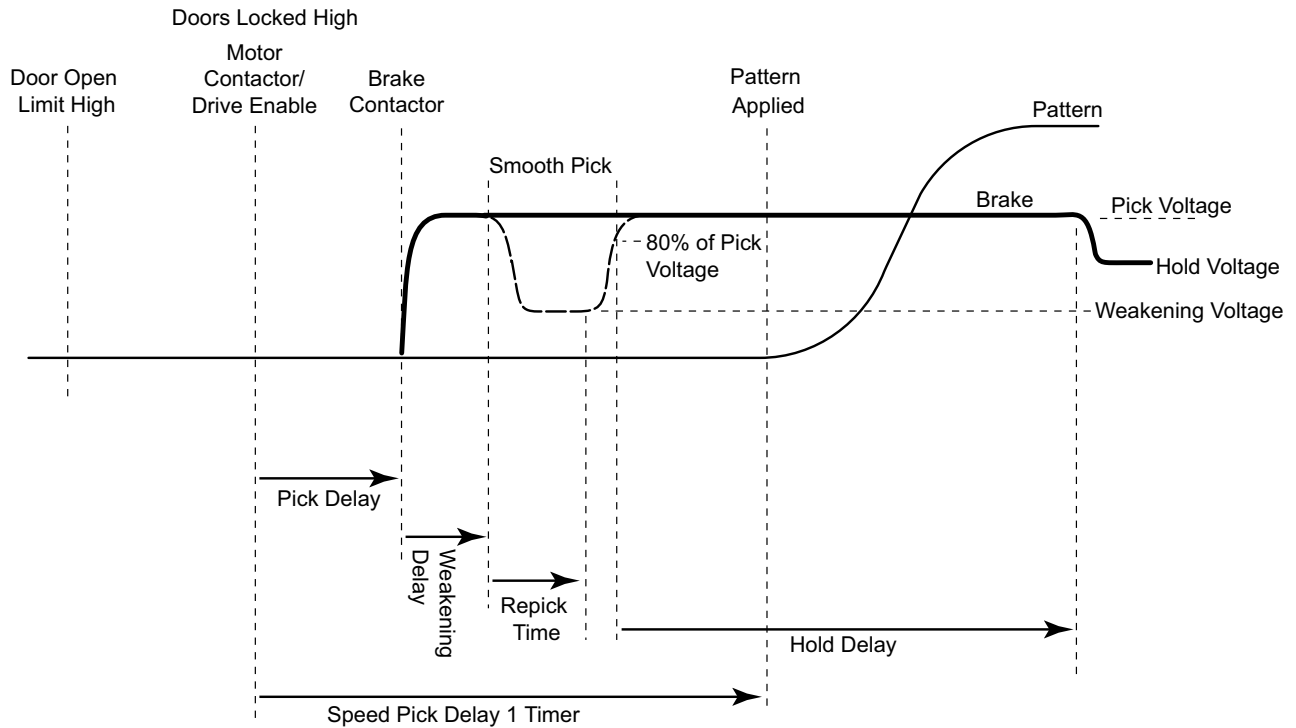
Caution

Do not use Pre-Start Sequence options until drive control parameters have been adjusted for no rollback and good control at zero speed.

Allow machine to be energized: After doors are locked

This is the default Pre-Start Sequence option. It specifies that the doors must be locked before energizing the motor and brake. The diagram below shows the parameters that affect this option and the resulting sequence of operation.

No Prestart Sequence with or without Smooth Pick

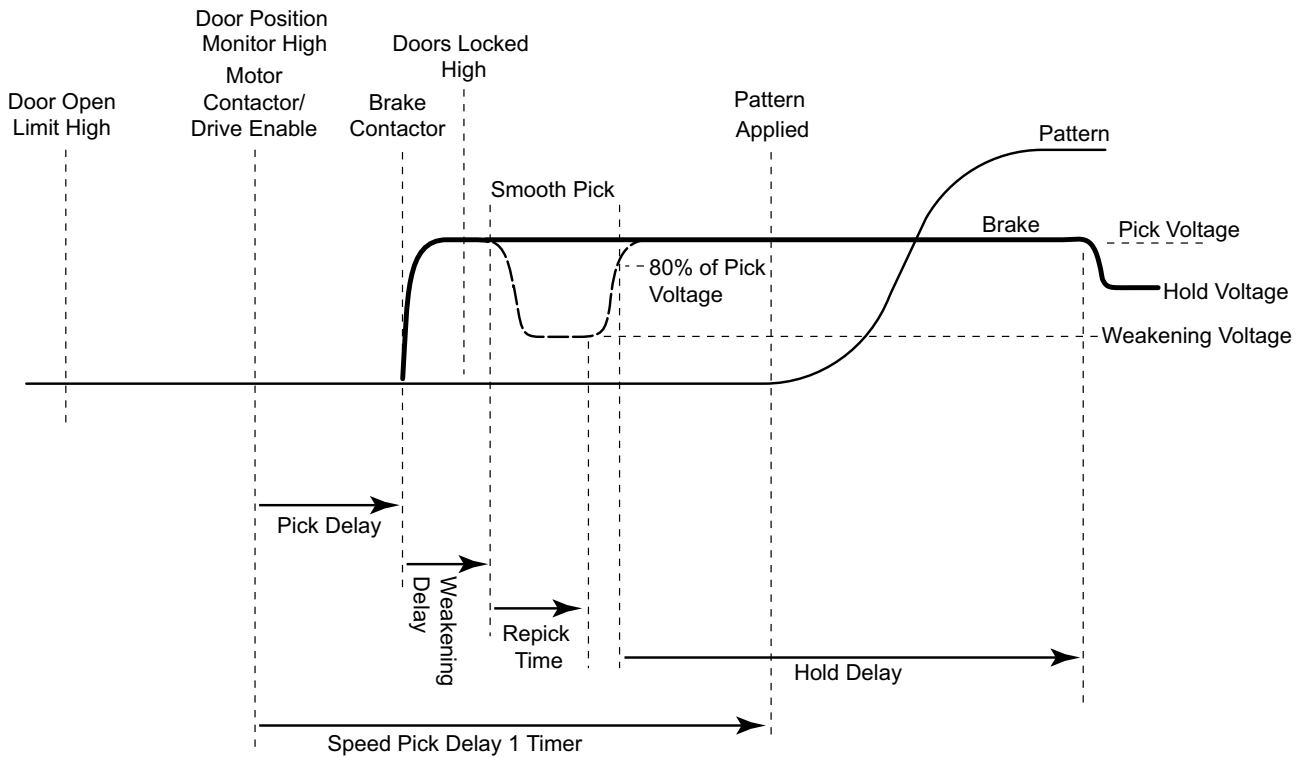


For a detailed description of the brake parameters associated with “smooth picking” and instructions for adjusting them, see [“Brake Parameter Adjustments”](#) on page 4-20.

**Allow the machine to be energized:
When the door position monitor is activated**

This Pre-Start Sequence option is much the same as the “After doors are locked” option except that Door Position Monitor status is used to determine when the machine may be energized rather than the Doors Locked sensors. The following diagram shows the parameters that affect this option and the resulting sequence of operation.

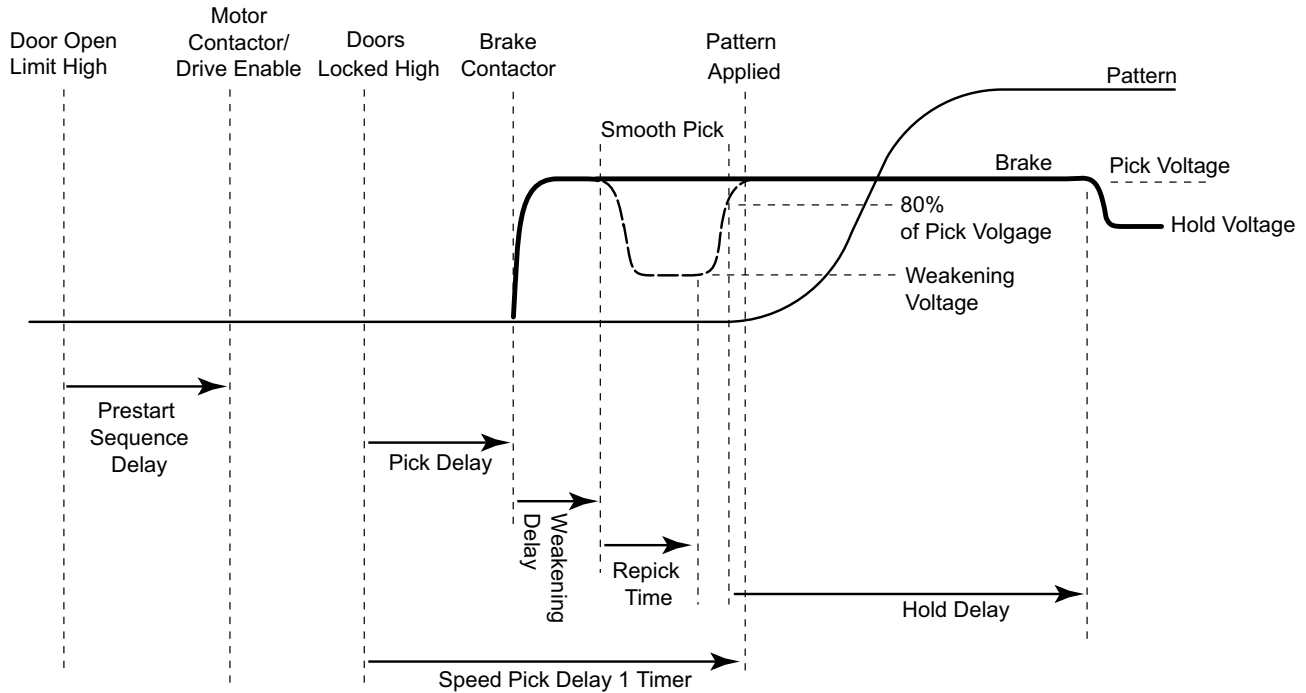
Allow machine to be energized after door position monitor is activated



**Allow the machine to be energized:
While doors are closing with motor only**

This Pre-Start Sequence option allows the motor to be energized while the doors are closing so that when the doors are locked, the brake picking sequence can be started immediately. The diagram below shows the parameters that affect this option and the resulting sequence of operation.

Prestart Sequence with Motor and No (Brake) Pick



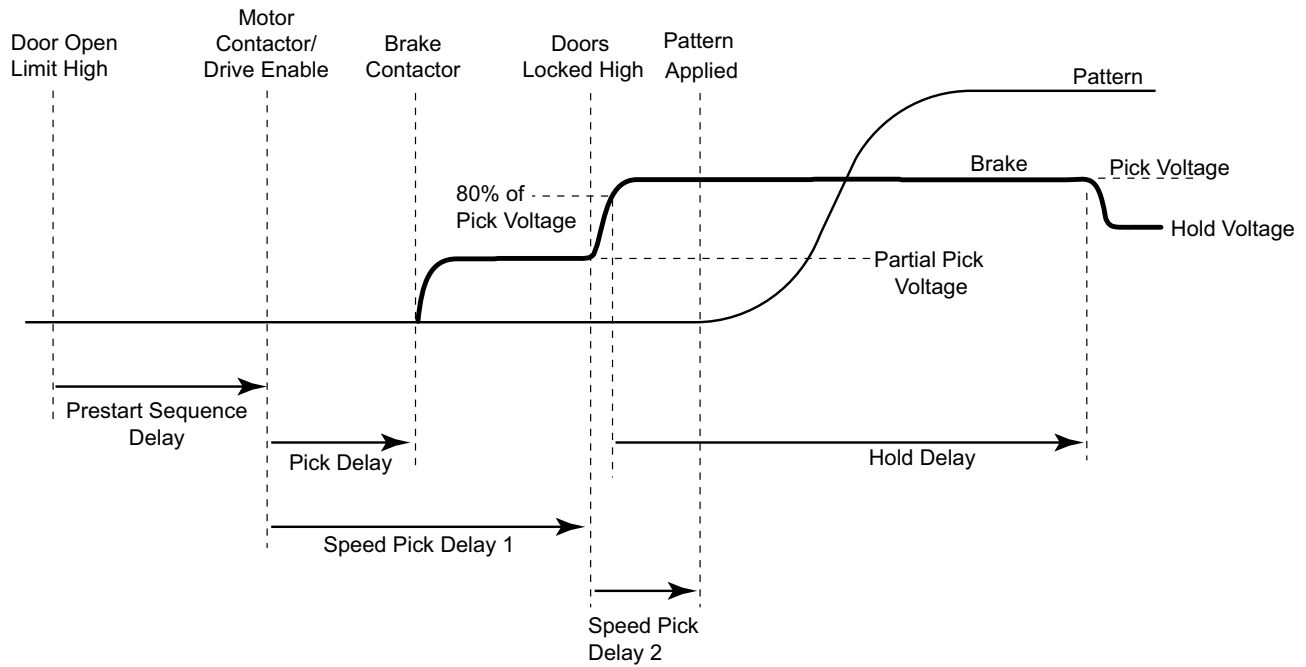
For a DC control, Pick Delay can be set to zero so long as the Pre-Start Sequence Delay is adjusted so that the motor is energized and able to hold the car at zero speed when the doors become locked.

For an AC control, some Pick delay may be required because it takes time for the drive to magnetize the motor once the contactor is picked and the drive enabled. A “Drive Ready On Fault” is generated if Pick delay is too short.

**Allow the machine to be energized:
While doors are closing with motor and partially picked brake**

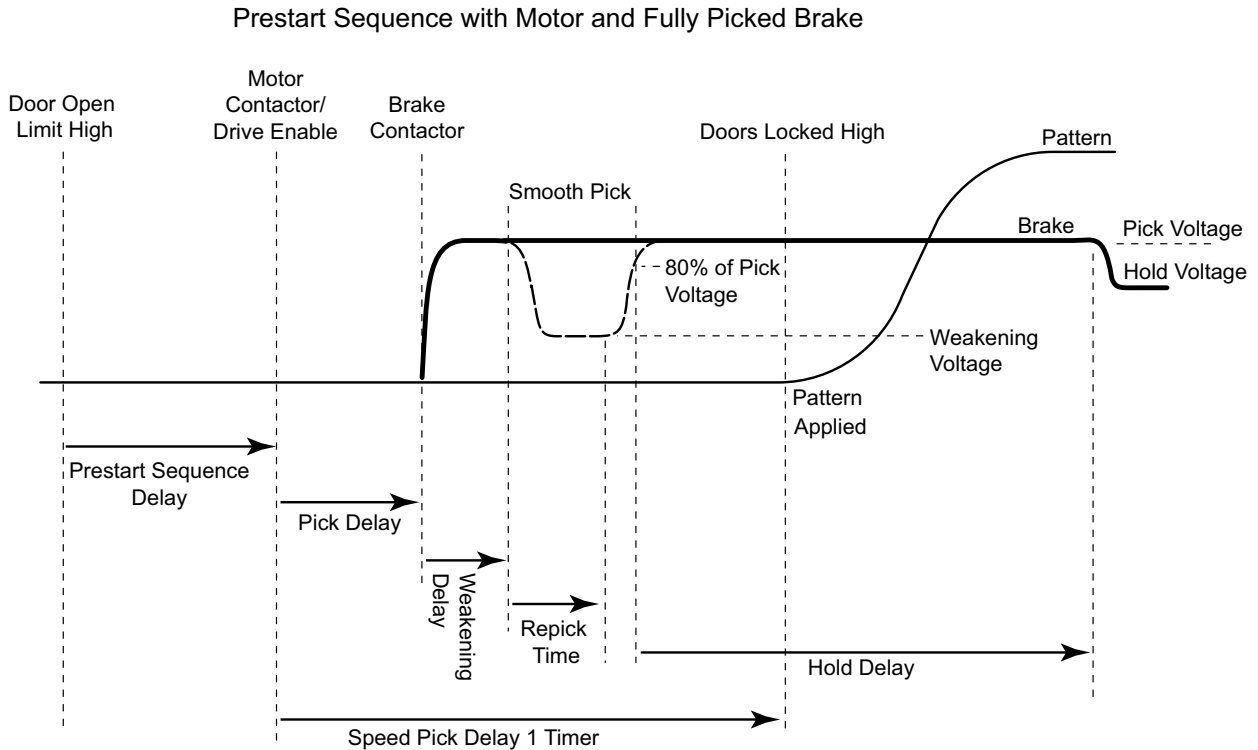
This Pre-Start Sequence option allows the motor to be fully energized and the brake to be partially energized while the doors are closing, so that when the doors become locked, the car can begin moving as soon as the brake is fully picked. The diagram below shows the parameters that affect this option and the resulting sequence of operation.

Prestart Sequence with Motor and Partially Picked Brake



**Allow the machine to be energized:
While doors are closing with motor and fully picked brake**

This Pre-Start Sequence option allows the motor and brake to be fully energized while the doors are closing, so that the car can begin moving when the doors become locked and the Speed pick delay 1 timer expires. The diagram below shows the parameters that affect this option and the resulting sequence of operation.



Calibration and Verification of Safety Functions

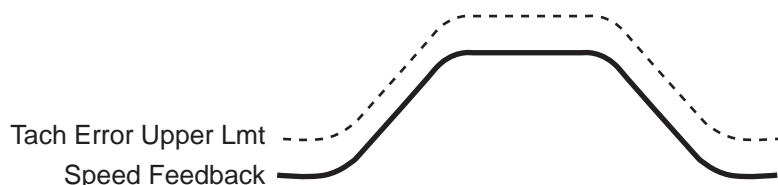
Before performing the calibration and verification of safety function please do the following:

1. Verify that the car performs the releveling operation properly. [Please refer to “Verify Releveling” on page 4-6](#) and see [“Releveling Operation” on page 4-29](#).
2. Perform the Normal and Emergency Terminal Limit Switches learn procedure. This is necessary if any pattern parameters have been changed since the last time the learn procedure was performed. [Please refer to “Learning Normal & Emergency Terminal Limit Switches” on page 4-9](#).

Tach Error Tripping Threshold Adjustment

This test compares the pattern signal with the velocity feedback signal and sets the point at which the Tach Error fault trips as a result of excessive error between the Actual and intended car speed.

1. Verify that the Tach Adj. trimpot has been properly adjusted. [Please refer to “Verify Pattern Command and Drive Speed Feedback” on page 2-56](#).
2. Arrange the car for full load condition.
3. Verify that the iBox Test switch is in the ON position.
4. On the Virtual Oscilloscope, set Test point 1 to *Speed Feedback* and Test point 2 to *Tach Error Upper Limit*. (Tach Error Upper Limit determines the upper threshold below which velocity feedback is allowed to deviate from the pattern.)
5. Start with *Following error* set to 1.0% (Configuration > Drive > Safety tab).
6. Set the iBox Fault/Function Bypass switch to the ON position. (Note that fault bypass is automatically disabled after a fifteen minute timer expires.)
7. On the Diagnostics > Fault Bypass tab, click *Tach error* (bypasses Tach Error fault).
8. Run the car up and down the hoistway. If the Speed Feedback trace on the Virtual Oscilloscope crosses the Tach Error Upper Limit trace, a Tach Error fault will normally be generated (we have it bypassed).
9. If the two traces on the oscilloscope cross, increase *Following error* in 5% increments, running the car with each change, until the two traces no longer cross.
10. When the two traces no longer cross, add 5% to the Following error setting as a margin.
11. Set Test point 2 to *Tach Error Lower Limit*. This is the lower threshold below which velocity feedback is allowed to deviate from the pattern.
12. Repeat steps 7 through 9 for Tach Error Lower Limit.



Verify Tach Error Does Not Trip on Emergency Stop

1. Set the iBox Fault/Function Bypass switch to the OFF position.
2. Make sure the Tach Error fault is no longer bypassed (Diagnostics > Fault Bypass tab).
3. With a full load in the car, run the car up and down the hoistway to verify that the Tach Error fault is not generated.
4. Enter a car call several floors below the car (so it can reach contract speed).
5. While the car is running at contract speed (Operational Status / Speed - Actual), disconnect the GS terminal from the iBox.
6. The car should trip a Door Lock Fault and make an Emergency Stop.
7. Observe that a Tach Error fault is not generated.

Safety Tests

iControl provides highly automated safety testing. Before running any tests, the car must be properly balanced and adjusted. From the iView Safety Tests screen (View > Safety Tests), the following tests may be run:

- Car/Counterweight Safety Test
- Electrical Governor Test
- Car/Counterweight Buffer Test
- Inspection Overspeed Test
- Contract Overspeed Test
- Emergency Brake Test - Unintended Motion
- Normal Terminal Switch Overspeed Tests - Level 1
- Normal Terminal Switch Overspeed Tests - Level 2
- Normal Terminal Switch Position Tests
- Emergency Terminal Switch Overspeed Test

The screenshot displays the 'Safety Tests' window with the following sections:

- Test Configuration:** Test Name: Car / Counterweight Safety Test; Speed: 0 ft/min; Select button.
- Runtime Status:**

Position	0.000	ft
Position indicator	60	
Speed	0.365	ft/min
Speed reference	500.000	ft/min
Maximum speed	0.451	ft/min
- System status:** Inspection (green), Test (green), Fault bypass (green).
- Fault Bypass Status:**

● Safety COS	● UNT1 Level 1	● DNT1 Level 1	● UNT1 Level 2	● DNT1 Level 2	
● Safety LOS	● UNT2 Level 1	● DNT2 Level 1	● UNT2 Level 2	● DNT2 Level 2	● UETS Level 2
● Safety IOS	● UNT3 Level 1	● DNT3 Level 1	● UNT3 Level 2	● DNT3 Level 2	● DETS Level 2
● Drive IOS	● UNT4 Level 1	● DNT4 Level 1	● UNT4 Level 2	● DNT4 Level 2	● Direction limit
● Speed Threshold	● UNT5 Level 1	● DNT5 Level 1	● UNT5 Level 2	● DNT5 Level 2	● Tach failure
- Test:**
 - Test Armed (green)
 - Ready to Arm (green)
 - Selected (green)
 - Disabled (green)
 - SAFETY SYSTEM TESTS - GENERAL INSTRUCTIONS
READ THIS PAGE BEFORE BEGINNING ANY TESTS
 - To perform a test-
1. Determine the car speed for the test
 - Arm Test button
 - Abort button

Running a Test

1. Put the iBox in Test mode.
2. Select the desired test on the Test screen.
3. Set the speed which the car must attain to trigger the condition being tested. (All tests except Emergency Brake Test/Unintended Motion require a speed input.)
4. Click the Select button. (Sends data to the controller and sets test conditions, including operating mode and active fault bypasses. Updates instructional display for specific test.)
5. Visually check on-screen operating mode and fault bypass status displays.
6. Perform instructions displayed on test screen.
7. Press Arm Test.
8. Place a car call as required to run the car up or down the hoistway (Call Registration panel).
9. Check Operational Status tab and Event Log (Diagnostics > Event Log) for fault verification.
10. Use the iBox Stop switch to stop the test and bring the elevator to an emergency stop if necessary.



Note

When running a test, you are allowed only one “motion cycle” of the car. If the test is not satisfactory, you will have to re-select that test to begin again. Remember that fault bypasses set for the test will time-out after 15 minutes. If you are delayed in completing a test, you may have to cycle the Fault Bypass switch to reset the fault bypasses.

Results Faults triggered by the tests are reported on the Operational Status tab and the Event Log. Non-latching (self-clearing) faults will only appear on the Operational Status tab for a few moments. Check the Event Log if the triggered faults have already disappeared from the Operational Status tab.

The following test descriptions provide information specific to each test.



Danger

During testing, normal system safeties are disabled. Exercise extreme caution. Be prepared to take control and stop the elevator if necessary. Only **QUALIFIED PERSONNEL**, with adequate experience and knowledge of elevator equipment should attempt elevator adjustment and testing.

Car/Counterweight Safety Test

This is a two-part test. Car safety testing verifies operation of the car safeties. The objective of the test is to set the safeties, causing the hoist motor to break traction. The over-speed must be sufficient in magnitude to cause the governor to trip mechanically and to set the car safeties. The electrical governor switch must not prevent the cars continued acceleration to the mechanical trip speed and the safety-operated switch (plank switch) must not open the safety string. To perform the Car Safety test:

1. Place a full load in the car.
2. Position the car some distance away from the bottom landing (about 10-feet per 100-foot-per-minute of contract speed).
3. Set Test Speed to 125% of Contract Speed.
4. On the iView, Configuration > Pattern > Modes tab, verify that *Deceleration* and *Approach deceleration* are set no higher than 2ft/s^2 to avoid tripping the drive.
5. Place a jumper between the #3 bus and the GOV terminal on the iBox to bypass tripping the governor overspeed.
6. Place a jumper between SAFH and SAFC on the iBox to bypass the safety plank (SOS).
7. For TORQMAX F5 software v1.61 or earlier, on the drive keypad:
 - Note the existing value of LF.57. Use the drive keypad to set LF.57 Speed Following Error to 0 (Off).
 - Record the value of LF.20 Contract Speed and LF.42 High Speed. Then change LF.20 and LF.42 to 130% of Contract Speed.

For TORQMAX F5 software v1.71 of later, on the drive keypad:

- Set LF.49 Over Speed Function Test to 130% of Contract Speed.
 - Set LF.3 = OStSt Over Speed Test Function. With LF.3 displayed, press FUNC to display the present value. Press UP/DOWN until OStSt is displayed, and then press ENTER to load the value. Car will over speed for one run only, after which parameters are automatically reset.
8. On the iView > Controller > View > Safety Tests tab, select the Car/Counterweight safety test. Complete on-screen instructions.
 9. Place a car call distant enough to allow the car to reach the necessary speed. If necessary, you may end the test and bring the car to an emergency stop using the iBox Stop switch.
 10. Remove jumpers placed for test.
 11. Return TORQMAX drive parameters to original values. NOTE: TORQMAX parameter LF.57 must be reset to its original value (On) or the drive will not run.
 12. Check the hoistway ropes to make sure they are still in their proper grooves before attempting to move the car.
 13. Use whatever method is required to reset the safeties. For flexible quick-clamp safeties, move the car on Inspection (UP and ENABLE buttons) to release the safety and restore the safety string.

Counterweight Safety Test - The counterweight safety test verifies operation of the counterweight safeties. For this test, position the empty car near the bottom landing and arrange to over-speed in the up direction. The test is comparable to the car safety test but performed in the opposite direction. If the counterweight has a governor, remember to jumper it out. Also, remember to remove jumpers when tests are complete.

Electrical Governor Test

This test verifies that the calibration of the electrical governor switch is appropriate (typically about 110% of contract speed) and that the car will execute an emergency stop once the electrical governor switch is activated. When the car trips the electrical governor switch in the down direction, it will execute an emergency stop.

1. Bring the car to the middle of the hoistway.
2. Check your mechanical governor nameplate for its tripping speed. Check the Contract Overspeed setting on the Configuration > Safety tab. Set a test speed sufficient to trigger the Contract Overspeed but not high enough to trip the mechanical governor.
3. Select the Electrical Governor test. Complete on-screen instructions.
4. Place a car call that will allow the car to reach the necessary speed.

Car/Counterweight Buffer Test

This is a two-part test. The car buffer test verifies that the car striking the buffer will cause the hoist motor to break traction and that the car buffer will automatically return to its fully-extended state after having been fully compressed. The car is arranged to run into the terminal landing without initiating any form of slowdown. Neither the final limit switch nor the buffer switch must stop the car.

1. Be certain that the pit is prepared, buffers ready, etc.
2. Place a full load in the car.
3. Position the car in the hoistway high enough to reach contract speed before reaching the bottom landing.
4. Place a jumper between the #3 bus and the SAFH terminal on the iBox to bypass the safety string.
5. Set Test speed to Contract Speed.
6. Select the Car/Counterweight Buffer test. Follow on-screen instructions.
7. Use the Inspection switches to run the car. If necessary, you may end the test and bring the car to an emergency stop using the iBox Stop switch.

The car must strike the buffer, compress it fully, and cause the hoist motor to break traction.

8. Check the hoistway ropes to make sure they are still in their proper grooves before attempting to move the car.
9. Lift the car off the buffer at inspection speed. (Normally accomplished after the inspector enters the pit to observe.) The buffer must return to full extension.

Counterweight Buffer Test - The counterweight buffer test verifies that the counterweight striking the buffer will cause the hoist motor to break traction and that the counterweight buffer will automatically return to its fully-extended state after having been fully compressed. The empty car is positioned near the bottom landing and arranged to reach contract speed in the up direction. The test is comparable to the car buffer test but performed in the opposite direction. If the counterweight has a governor, remember to jumper it out.



Note

These tests may cause the load weigher to go out of calibration. [Please refer to “Learning Load Values” on page 4-33.](#)

Inspection Overspeed Test

This test verifies that moving the elevator on Inspection Operation at a speed greater than 150 fpm will result in an emergency stop.

1. Place the car on machine room inspection.
2. Verify that Inspection Overspeed (Controller > View > Setup > Safety > Configuration tab) is set to 150 fpm.
3. Position the car in the middle of the hoistway.
4. On the View > Safety Tests screen, set Test speed to 200 fpm.
5. Select the Inspection Overspeed test. Follow on-screen instructions.
6. Use the inspection buttons to move the car when ready.

When the car exceeds 150 fpm, the overspeed condition must stop it.

Contract Overspeed Test

This test verifies that moving the elevator at a speed greater than the programmed contract overspeed value will result in an emergency stop.

1. Position the car in the middle of the hoistway.
2. The test *speed* must exceed the programmed Contract Overspeed value shown on the *Controller > View > Setup > Safety* tab (typically 107% of contract speed), but not high enough to cause the electrical or mechanical governor to activate. Contract Overspeed plus 15 fpm should be sufficient. You may have to physically bypass the electrical Governor switch.
 - For TORQMAX F5 software v1.61 or earlier, on the drive keypad:
 - Record the value of LF.20 Contract Speed and LF.42 High Speed.
 - Then change LF.20 and LF.42 to the test *Speed* determined above.
 - For TORQMAX F5 software v1.71 or later, on the drive keypad:
 - Set LF.49 Over Speed Function Test to the test *Speed* determined above.
 - Set LF.3 = OStSt Over Speed Test Function. With LF.3 displayed, press FUNC to display the present value. Press UP/DOWN until OStSt is displayed, and then press ENTER to load the value. Car will over speed for one run only, after which parameters are automatically reset.
3. On the *Controller > View > Safety Tests* tab, select the Contract Overspeed test.
4. Enter the desired test *Speed* determined in step 2 and then click *Select*.
5. Follow the on-screen instructions.
6. When the car exceeds the programmed contract overspeed value, the car must perform an emergency stop.
7. If they were changed, reset LF.20 and LF.42 to the values recorded in step 2.

Leveling Overspeed Test

This test verifies that the leveling zone does not exceed the maximum allowable distance and that the leveling speed does not exceed 150 ft/min (0.75 m/s). (NOTE: Be sure to make note of the original parameter values so they can be restored after the test):

1. On the Configuration > Drive > General tab, set *Emergency rate limited stop* = 25 ft/s².
2. On the Setup > Safety > Configuration tab, set *Leveling overspeed* = 7 fpm and click *Send*. Then perform the *Learn* operation.
3. On the Configuration > Pattern > Common tab, set *Leveling distance* = 4 in, set *Leveling speed* = 9 fpm, and click *Send*.
4. Place a call to any landing. Verify that when the car enters the leveling zone, the system detects a Safety A (or B) Inspection Leveling Overspeed Fault and performs an emergency stop. Following the emergency stop the car should level into the floor, if necessary. (NOTE: If the car is unable to relevel into the floor and the fault is generated 5 times, the fault will become persistent and the iBox Fault Reset button must be pressed to reset the fault. It may be necessary to restore the parameters that were changed in steps 1 through 3 in order for the car to relevel to the floor.)
5. Restore the parameters that were changed in steps 1 through 3 to their original values.

Emergency Brake Test - Unintended Motion - Rope Brake



Danger

The Emergency Brake test allows the car to leave the floor with doors open. Station personnel or use a positive means to make certain there is NO ONE in the car.

This test is to be used for installations using a rope brake for the emergency brake. This test verifies that moving the car away from a landing with both the car and hoistway doors open (termed “Unintended Motion”) will cause the Emergency Brake (Rope Brake) to be deployed and that such deployment will stop the elevator. This test also demonstrates that the emergency brake will stop the car within 48” from the floor level if it drifts. No “Test speed” entry is required for this test.

1. Load the car as required, empty car going up or 125% of full load going down.
2. Move the car to the landing where the test is to be performed.
3. For safety, station a mechanic at the landing where the test is to be performed.
4. On the iView Safety Tests tab, select the Emergency Brake Test - Unintended Motion (View > Safety Tests > Test Name parameter).
5. Follow on-screen instructions “To perform an unintended motion test-”.
6. Once the test has been armed and the car doors have been opened, place a car call to the top or bottom terminal landing. The car will start to move with it’s door open and trip an Unintended Motion Fault.
7. The emergency brake must activate and stop the car within 48” (1220 mm). Power is removed from the driving machine and brake. Place the car on Inspection and press the iBox “Fault Reset” button to reset the fault.

Emergency Brake Test - Unintended Motion - Machine Brake



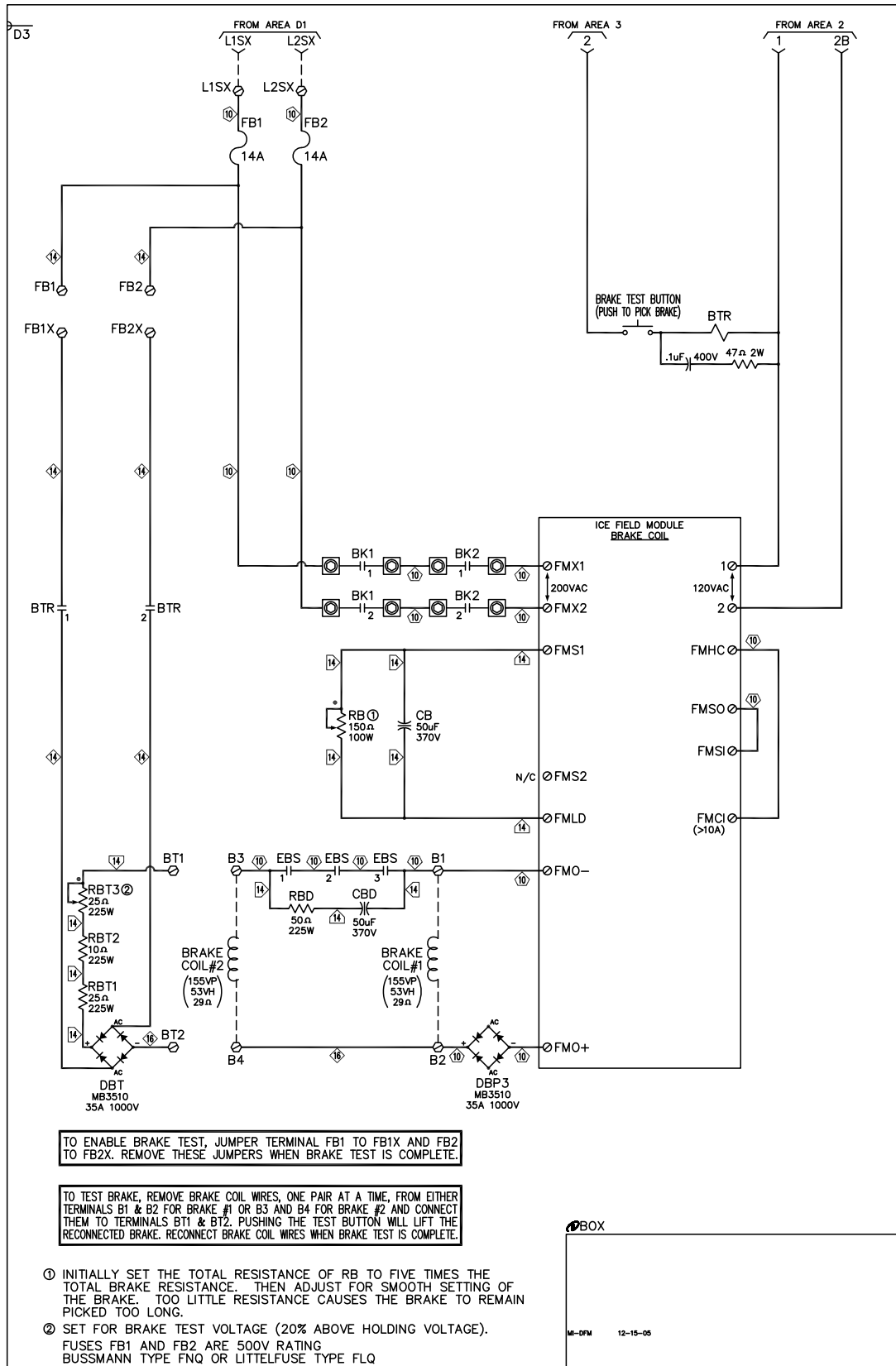
Danger

The Emergency Brake test allows the car to leave the floor with doors open. Station personnel or use a positive means to make certain there is NO ONE in the car.

This test is to be use for installations where one or more machine brakes are used for (designated as) the emergency brake. This test verifies that moving the car away from a landing with both the car and hoistway doors open (termed “Unintended Motion”) will cause the Emergency Brake (Machine Brake(s)) to be deployed and that such deployment will stop the elevator. This test also demonstrates that the emergency brake will stop the car within 48” from the floor level if it drifts. [Please refer to “Typical Brake Test Circuit: Machine Brake Emergency Brake” on page 4-50.](#)

1. Load the car as required, empty car going up or 125% of full load going down.
2. Move the car to the landing where the test is to be performed.
3. To enable the brake test, place jumpers from terminal FB1 to FB1X and from FB2 to FB2X (see Figure 4.6).
4. To test the emergency brake, remove the brake coil wires of the main brake from their normal terminals, e.g., B1 & B2, and connect them to terminals BT1 & BT2. Note: If the machine has a set of two or more brakes designated as the emergency brake, move the brake coil wires for all brakes *not* being tested to terminals BT1 and BT2.
5. For safety, station a mechanic at the landing where the test is to be performed.
6. On the iView Safety Tests tab, select the Emergency Brake Test - Unintended Motion (View > Safety Tests > Test Name parameter).
7. Follow on-screen instructions “To perform an unintended motion test-”.
8. Click the “Arm Test” button. The car doors will open.
9. Press and hold the BRAKE TEST BUTTON to lift the brake(s) *not* being tested, and then place a car call to the top or bottom terminal landing. The car will start to move with it’s door open and trip an Unintended Motion Fault.
10. The brake(s) being tested must activate and stop the car within 48” (1220 mm). Power is removed from the driving machine and brake. Release the BRAKE TEST BUTTON once the car has fully stopped. Place the car on Inspection and press the iBox “Fault Reset” button to reset the fault.
11. Return the brake coil wires connected to terminals BT1 and BT2 to their normal terminals.
12. Repeate steps 4 through 11 for any additional emergency brakes.
13. Repeat the test for the main brake(s), leaving the brake coil wires for the main brake connected to their normal terminals and moving the brake coil wires for the brake(s) designated as the emergency brake to terminals BT1 and BT2. Repeat steps 5 through 11.
14. When the tests have been completed, return all brake coil wires to their normal terminals and remove the jumpers from terminal FB1 to FB1X and FB2 to FB2X.

Figure 4.6 Typical Brake Test Circuit: Machine Brake Emergency Brake



Ascending Car Overspeed Test - Rope Brake

This test is to be used for installations using a rope brake for the emergency brake. It verifies that the emergency brake (rope brake) will stop an empty car that is over-speeding in the up direction.

1. Move the empty car to the bottom of the hoistway.
2. Check the mechanical governor nameplate for its tripping speed. Check the Contract Overspeed setting (Controller > View > Setup > Safety > Configuration tab).
3. On the iView Safety Tests tab, select the Electrical Governor Test (View > Safety Tests > Test Name parameter).
4. Enter a *Speed* sufficient to trigger the Contract Overspeed but not high enough to trip the mechanical governor.
5. Acquire *Write privilege* and then click the *Select* button.
6. Follow on-screen instructions “ELECTRICAL GOVERNOR TEST SETUP” and “To perform and Electrical Governor test-”.
7. Once the test is “Armed”, place a car call distant enough to allow the car to reach the necessary speed.
8. When the electrical governor is activated the rope brake will be deployed. Power is removed from the driving machine and brake. Place the car on Inspection and press the iBox “Fault Reset” button to reset the fault.

Ascending Car Overspeed Test - Machine Brake

This test is to be used for installations where one or more machine brakes are used for (designated as) the emergency brake. This test verifies that the emergency brake (machine brake) will stop an empty car that is over-speeding in the up direction. [Please refer to “Typical Brake Test Circuit: Machine Brake Emergency Brake” on page 4-50.](#)

1. Move the empty car to the bottom of the hoistway.
2. To enable the brake test, place jumpers from terminal FB1 to FB1X and from FB2 to FB2X (see Figure 4.6).
3. To test the emergency brake, remove the brake coil wires of the main brake from their normal terminals, e.g., B1 & B2, and connect them to terminals BT1 & BT2. Note: If the machine has a set of two or more brakes designated as the main brake, move the brake coil wires for all brakes *not* being tested to terminals BT1 and BT2.
4. Check the mechanical governor nameplate for its tripping speed. Check the Contract Overspeed setting (Controller > View > Setup > Safety > Configuration tab).
5. On the iView Safety Tests tab, select the Electrical Governor Test (View > Safety Tests > Test Name parameter).
6. Enter a *Speed* sufficient to trigger the Contract Overspeed but not high enough to trip the mechanical governor.
7. Acquire *Write privilege* and then click the *Select* button.
8. Follow the on-screen instructions “ELECTRICAL GOVERNOR TEST SETUP” and “To perform and Electrical Governor test-”.
9. Once the test is “Armed”, press and hold the BRAKE TEST BUTTON to lift the brake(s) *not* being tested, and then place a car call distant enough to allow the car to reach the necessary speed.
10. When the electrical governor is activated the machine emergency brake will be deployed. Power is removed from the driving machine and brake. Release the BRAKE TEST BUTTON once the car has fully stopped. Place the car on Inspection and press the iBox “Fault Reset” button to reset the fault.
11. Return the brake coil wires connected to terminals BT1 and BT2 to their normal terminals.
12. Repeat the test for the main brake(s), leaving the brake coil wires for the main brake connected to their normal terminals and moving the brake coil wires for the brake(s) designated as the emergency brake to terminals BT1 and BT2. Repeat steps 5 through 11.
13. When the tests have been completed, return all brake coil wires to their normal terminals and remove the jumpers from terminal FB1 to FB1X and FB2 to FB2X.

Normal Terminal Switch Overspeed Tests

Per switch, this test verifies that either an emergency slowdown or emergency stop will be initiated if an elevator encounters an NTS switch and is moving at a speed greater than the programmed overspeed value for that switch. The car is arranged to run toward the target NTS switch without initiating any form of slowdown. When the car activates the NTS switch, it will execute either an emergency slowdown or an emergency stop, depending upon the overspeed margin detected. The car will then finish the run to a landing at leveling or correction speed.

1. It is imperative that deceleration and jerk rates for the Emergency slowdown profile be set to greater values than Standard profile deceleration and jerk rates so that initiation of an emergency slowdown will stop the elevator quickly and safely. Check the Standard and Emergency slowdown profiles to see that this is the case. For a typical, 500 fpm car, Standard jerk and deceleration settings might be 4.0 and 3.0 respectively; for the Emergency slowdown profile, jerk and deceleration might be 15.0 and 6.0 respectively. Adjust the Emergency slowdown profile parameters as necessary to ensure a rapid, aggressive stop sufficient to avoid running the car into the buffer.
2. Go to the Configuration > Pattern > Modes tab/Emergency slowdown profile and verify that *Deceleration* is set correctly. It is generally set to 5.0, and must be greater than the Standard profile - Deceleration parameter.
3. Go to the Configuration > Drive > General tab and verify that *Emergency rate limited stop* is set correctly. It is generally set to 7.0, and must be greater than the Emergency slowdown profile - Deceleration parameter.
4. Position the empty car far enough away from the target NTS switch to allow a speed to be reached that exceeds the learned overspeed value for that switch for the Overspeed Level 1 or Level 2 (whichever is being tested).
5. Go to the Diagnostics > Terminal Switches Status tab. Note the Overspeed 1 and 2 speeds learned for the terminal switch to be tested.
6. On the Safety Test window, select Normal Terminal Switch 'n' Overspeed Test - Level 'n' for the switch and level to be tested.
7. Set the test *Speed* to the Overspeed 1 (Level 1) or Overspeed 2 (Level 2) speed, plus 10 fpm, for the switch/test. **Caution!** If the speed is set below the overspeed threshold, no slowdown will be initiated and the elevator/counterweight will strike the buffer.
8. Follow on-screen instructions and perform the test. The car should perform either an emergency slowdown or emergency stop. For additional information see [“Terminal Switch Overspeed and Position Faults”](#) on page 4-55.
9. On the Operational Status tab, verify that the appropriate fault is shown in the Faults window.
10. Continue testing the remaining normal terminal switches by repeating steps 4 through 9.

Emergency Terminal Switch Overspeed Tests

Per switch, this test verifies that an emergency stop will be initiated if an elevator that is moving at a speed greater than 95% of the programmed contract speed encounters the ETS switch in the cars direction of travel (DETS if the car is moving in the down direction, UETS if the car is moving in the up direction). The empty car is set far enough away from the desired terminal landing to achieve contract speed by the time it reaches the ETS switch in the selected direction. The car is arranged to run toward the desired terminal landing without initiating any form of slowdown. When the car activates the ETS switch, it will execute an emergency stop. The car will then finish the run to a landing at leveling or correction speed.

1. Go to the Configuration > Drive > General tab and verify that *Emergency rate limited stop* is set correctly. It is generally set to 7.0, and must be greater than the Emergency slowdown profile - Deceleration parameter.
2. Position the empty car far enough away from the target ETS switch to allow a speed to be reached that exceeds the learned overspeed value for that switch.
3. Go to the Diagnostics > Terminal Switches Status tab. Note the overspeed 2 value learned for the emergency terminal switch to be tested.
4. Select Emergency Terminal Switch Overspeed Test on the Safety screen.
5. Set the test *Speed* to the overspeed speed for the switch/test, plus 10 fpm. **Caution!** If the speed is set below the overspeed threshold, no slowdown will be initiated and the elevator/counterweight will strike the buffer.
6. Follow on-screen instructions and perform the test. For additional information see [“Terminal Switch Overspeed and Position Faults” on page 4-55.](#)
7. On the Operational Status tab, verify that the appropriate fault is shown in the Faults window.
8. Continue testing the remaining emergency terminal switch by repeating steps 2 through 7.

Normal and Emergency Terminal Switch Position Tests

1. On the Configuration > Terminal Switches tab, for the switch you wish to test, set the position margin to a negative value (place a minus sign in front of the value).
2. If you are testing an up terminal switch, run the car past the switch in the up direction at contract speed (if possible). If you are testing a down terminal switch, run the car past the switch in the down direction at contract speed (if possible). The car should stop using the Emergency slowdown profile parameters.
3. On the Operational Status tab, verify that the appropriate fault is shown in the Faults window.
4. On the Configuration > Terminal Switches tab, set the position margin for the tested switch back to the original positive value
5. Continue testing the remaining switches using steps 1 through 4.

Terminal Switch Overspeed and Position Faults

The Overspeed Level 1, Level 2 and Position margins are calculated based on the speed and position values learned during the terminal learn procedure (see [“Learning Normal & Emergency Terminal Limit Switches”](#) on page 4-9)

Overspeed level 1 - During passenger (NORM) operation, if car speed exceeds the Overspeed Level 1 threshold at the time a Normal Terminal switch is activated, an Up (or Down) Normal Terminal Switch (1-5) Level 1 Speed Fault is detected and an immediate slowdown is initiated using Emergency slowdown profile parameters. For each Normal Terminal switch, the Overspeed Level 1 threshold is calculated by increasing the learned speed by a percentage of the learned speed, e.g. learned speed plus 10% of learned speed. The percentage used in the calculation is determined by the Overspeed 1 margin parameter. You may adjust the Overspeed Level 1 threshold by changing the Overspeed 1 margin parameter (Configuration > Terminal Switches tab). The default setting is 8%. Normally, you should not have to adjust this setting.



Note

Sometimes short runs to a terminal, especially one-floor runs, will exceed tightly set overspeed margins. After you learn terminal switches, it is a good practice to try a few short runs to each terminal and check the Last pass speeds against the Learned speeds for each switch (Diagnostics > Terminal Switches Status tab). If necessary, you can then adjust the Overspeed 1 margin to accommodate (possibly) higher short run switch speeds. (Overspeed level 1 faults cause an emergency slowdown into the terminal landing but the fault is automatically cleared so it is possible to miss the fact that this is occurring.)

Overspeed level 2 - During passenger (NORM) operation, if car speed exceeds the Overspeed Level 2 threshold at the time a Normal Terminal switch is activated, an Up (or Down) Normal Terminal Switch (1-5) Level 2 Speed Fault is detected and an emergency stop is initiated (motor and brake contactors immediately dropped). The Overspeed Level 2 threshold is calculated as 105% of the Overspeed Level 1 threshold

Position - During passenger (NORM) operation, if car position varies from the learned position by more than the Position Margin at the time a Normal Terminal or Emergency Terminal switch is activated, an Up (or Down) Normal Terminal Switch (1-5) Position Fault or an Up (or Down) Emergency Terminal Switch Position Fault is detected and an immediate slowdown is initiated using the Emergency slowdown profile parameters. The Position Margin for each Normal Terminal or Emergency Terminal switch is displayed and may be adjusted on the Configuration > Terminal Switches tab. The default value is 2.0 feet.

4

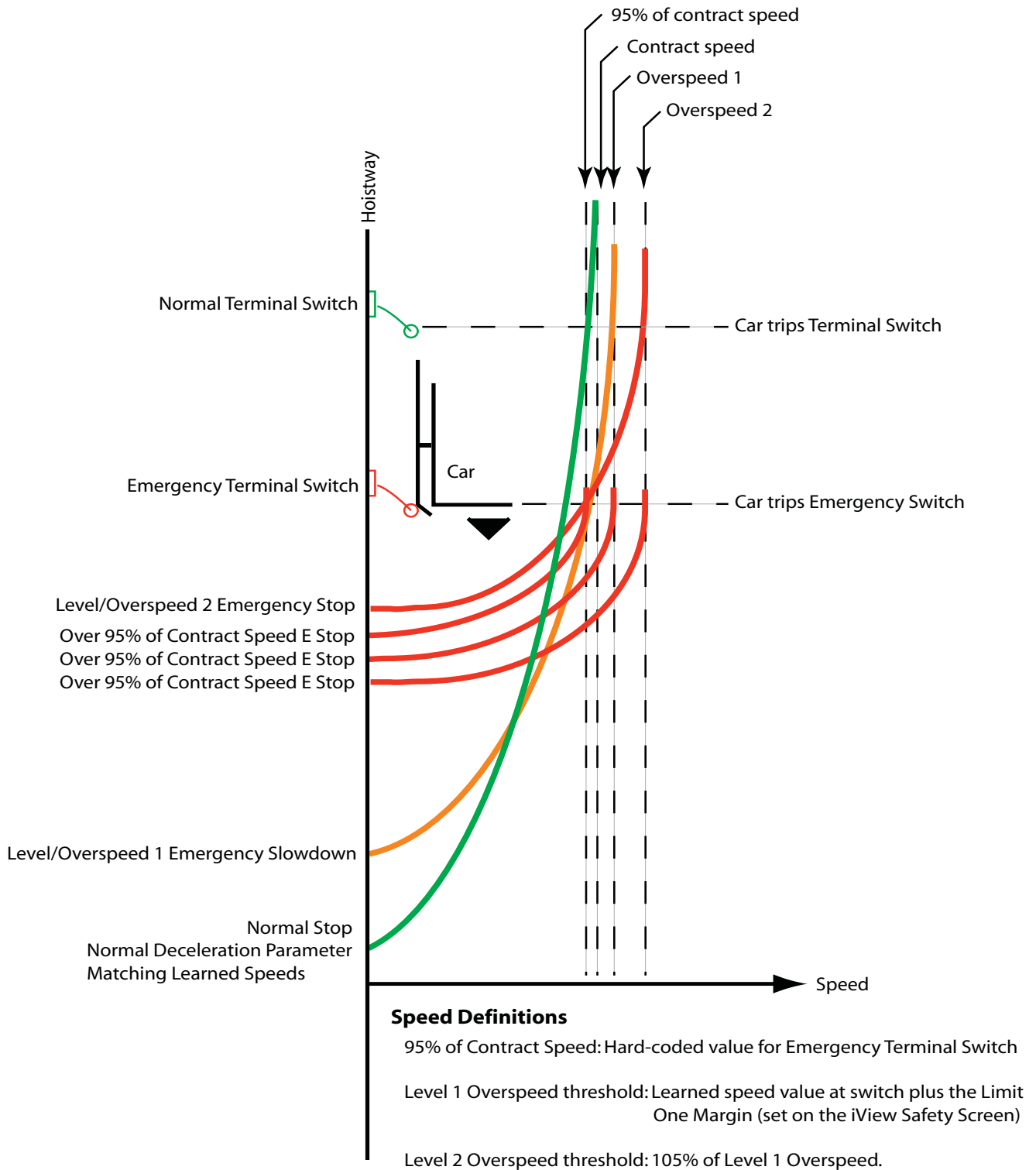


Caution

Emergency Terminal (switches) Overspeed is hard-coded at 95% of Contract Speed. Be certain that the car is traveling well below this speed when an Emergency Terminal switch is opened to avoid an emergency stop. In some instances, it may be necessary to re-position an Emergency Terminal switch to achieve this. This value is **NOT** affected by the Overspeed 1 margin setting.

The following illustration shows the car reaction to overspeed conditions at Normal and Emergency Terminal switches in the down direction.

Figure 4.7 Emergency and Normal Terminal Overspeed Reaction



Before Release to Passenger Operation



Danger

Before the elevator can be turned over to normal passenger use, it is important that no safety function or circuit remains bypassed. Items to check include, but are not limited to:

- All safety switches set to the OFF position
- No jumper between SB and 3 (iBox)
- No jumper between SAFH and 3 (iBox)
- Learn and Fault/Function switches set to OFF (iBox)
- TORQMAX Drive: Parameters LF.20 Contract Speed and LF.42 High Speed set to their original values. Also, set LF.57 Speed Following Error = 1 (ON)
- No jumper between Gov and 3 (iBox)
- Pattern Scaling set to 100% (Pattern screen/Common tab)



Note

If this is a local car (part of a group), the “Car identifier” parameter, on the Configuration > General > General tab, must be set so that the Group controller can identify the car to which it is communicating, see [“Configuration - General” on page 9-95](#) Initially the Car identifier is defaulted to 1. The Car Identifier range is from 1 to 20. The Car identifier for each car in a Group must be unique (no duplicates).





Quick Topics

- **About Options**
- **iCentral**
- **Comm-connect**
- **Serial Hall Call**
- **Flexible I/O**
- **Serial COP**
- **EMCO Load Weigher**
- **MCE Load Weigher**



System Options



About System Options

This section contains supporting information for optional iControl system components, including:

- **iCentral - Central Dispatcher:** Description, installation and setup instructions for the Central Dispatcher (see [page 5-2](#)).
- **Comm-Connect Cabinet - Local/Dispatcher:** Description of the cabinet used for the Local Dispatcher system interconnections (see [page 5-28](#)).
- **Serial Hall Call:** Description, installation and troubleshooting instructions for the Serial Hall Call system (see [page 5-30](#)).
- **Flexible I/O:** Description of the SC-ION Serial Input/Output board (see [page 5-45](#)).
- **Serial COP (Car Operating Panel):** Description and installation instructions for the Serial COP system and boards (see [page 5-48](#)).
- **EMCO Load Weigher:** Description, installation and calibration instructions for the EMCO Load Weigher (see [page 5-53](#)).
- **MCE Load Weigher:** Description, installation and calibration instructions for the MCE Load Weigher (see [page 5-63](#)).

iCentral - Central Dispatcher

iCentral is the central dispatching option for iControl, providing a central point to coordinate dispatching, parking, special operating modes, emergency power response, security, and interaction with existing (legacy) controls. This option is used for the most demanding systems.

With iCentral, the iCue dispatching software runs on a dedicated Windows PC or an embedded micro controller. You configure and interact with iCue using a Windows XP personal computer running the iView graphical user interface. iView is also used to connect to individual elevator controllers in the iControl group. iView automatically provides the correct user interface depending on the type of control (dispatcher or elevator) you are accessing.

The standard iCentral enclosure is a single-door cabinet measuring approximately 28-inches wide by 23-inches deep by 72-inches tall (71cm wide x 58cm deep x 183cm tall). The cabinet provides two fixed shelves (for a monitor and a KVM switch and iCue and iView computers respectively), a sliding keyboard/mouse tray, and a peripherals/equipment interconnect area configured to meet the requirements of the individual job. A typical equipment complement includes LAN and System Ethernet hubs, SC-I/O addressable input/output boards, serial communication bus drivers, a second computer, and modular terminals to accommodate machine room and hoistway field connections.

Each iCentral will administer an elevator group servicing up to a design maximum, one hundred-fifty floors. Functionally, iCue provides the kinds of interconnection and control shown in the following illustration.

Switching Between iCue & iView PCs

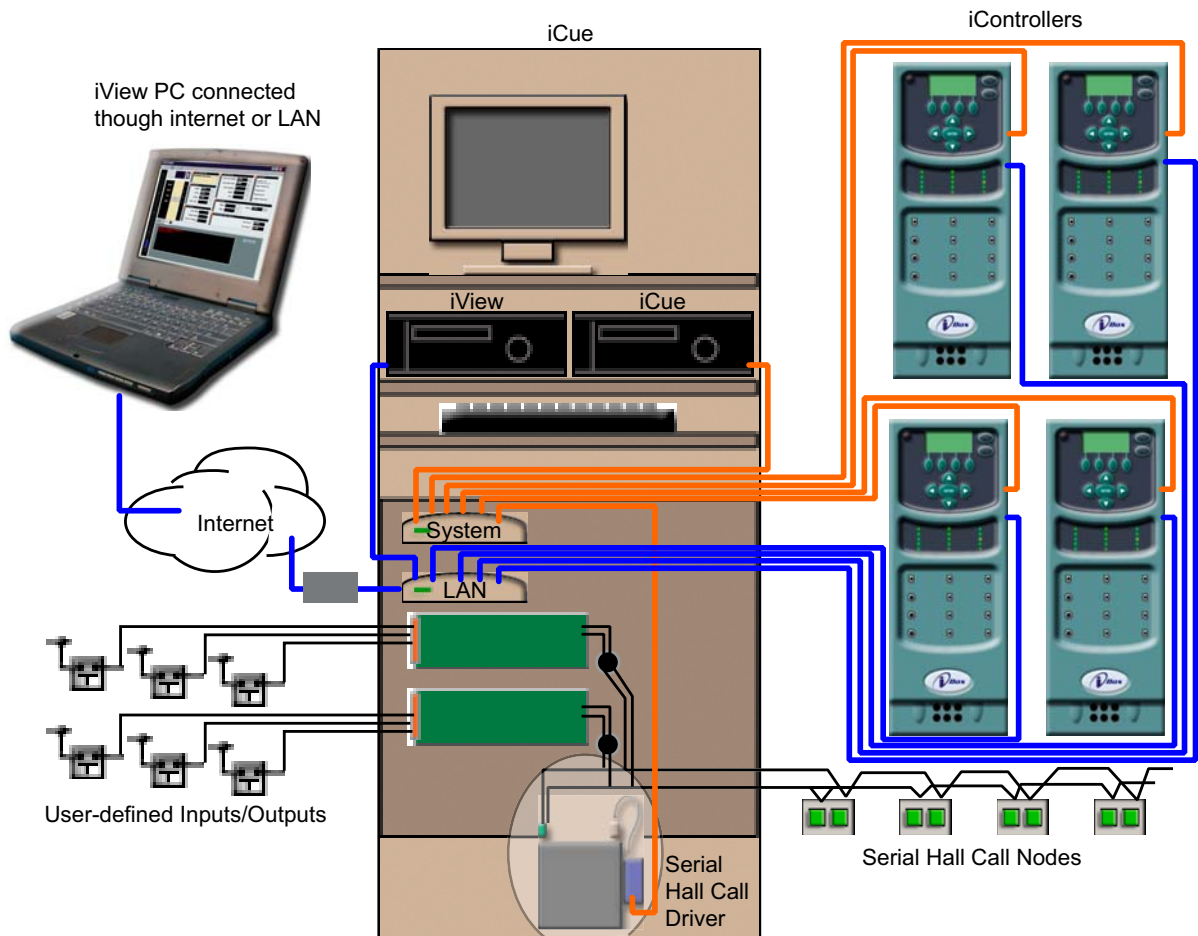
The iCue PC runs the real time dispatching software that controls the elevator group. The iView PC connects to iCue or to individual car controls and allows you to configure them using the iView application. The two PCs share the single keyboard/mouse and monitor. Press the <Scroll Lock> key twice to switch from one PC to the other.



Note

Before using iView to change iCue settings, you must request and be granted write permission. When you request write permission, you must immediately switch to the iCue PC and grant permission in the pop-up dialog that appears. (This prevents remote iView connections from changing settings without the permission of machine room personnel.)

Figure 5.1 iCentral Functional Diagram



iCue Dispatching Capabilities

- Design maximum 150 landings
- Design maximum 20 cars per group
- Anticipates and adapts to changing traffic demands using Artificial Intelligence
- Define up to eight independent configurations each for Hall Call Eligibility, Parking Assignment, Parking Eligibility, Operating Mode, and Security – activated manually or by user-defined timers
- Continuously evaluates multiple dispatching scenarios, maximizing efficiency
- Dedicated 100 Megabaud network handles data efficiently
- Intelligent, user-defined parking system
- Supports SmartLINK hall call system, MCE-ready fixtures
- Independent, backup dispatching on one of the iControls in the elevator group takes over dispatching if iCentral is taken off line or fails

System Interconnect

It can be helpful to have a general understanding of the way the entire iControl system is interconnected. This section contains high-level interconnection drawings for:

- **System Interconnection:** Basic car control and dispatcher interconnections.
- **Dispatcher Interconnection:** More detail for dispatcher interconnections.
- **iControl Interconnection:** More detail for car controller interconnections.
- **Cartop Interconnection:** More detail for cartop interconnections.

Figure 5.2 iControl System LAN Interconnection

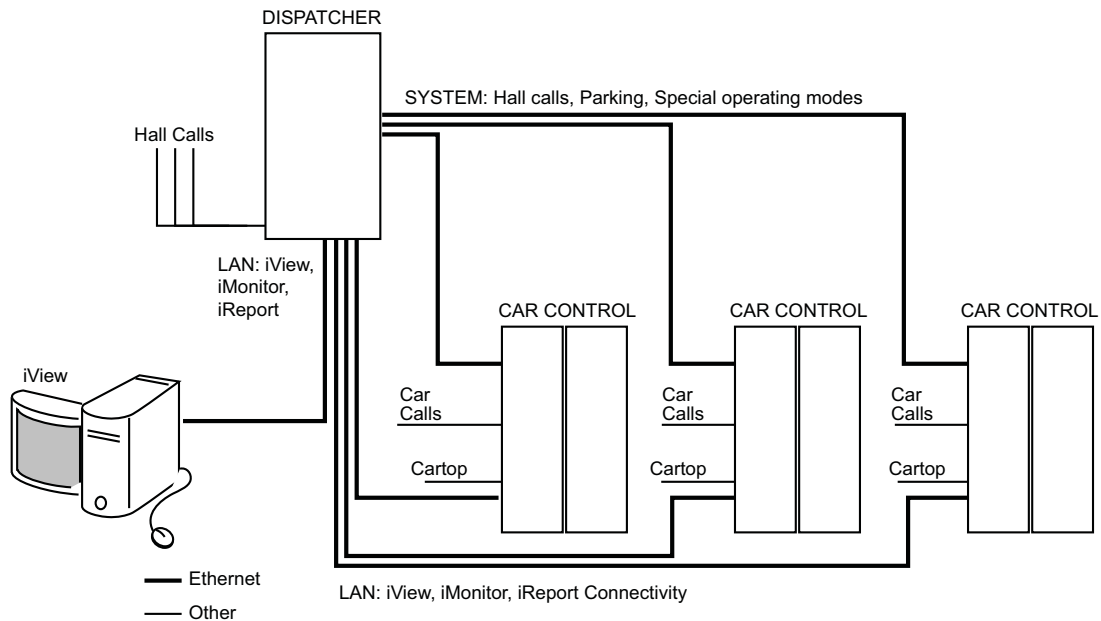


Figure 5.3 Central Dispatcher (iCentral) Interconnection

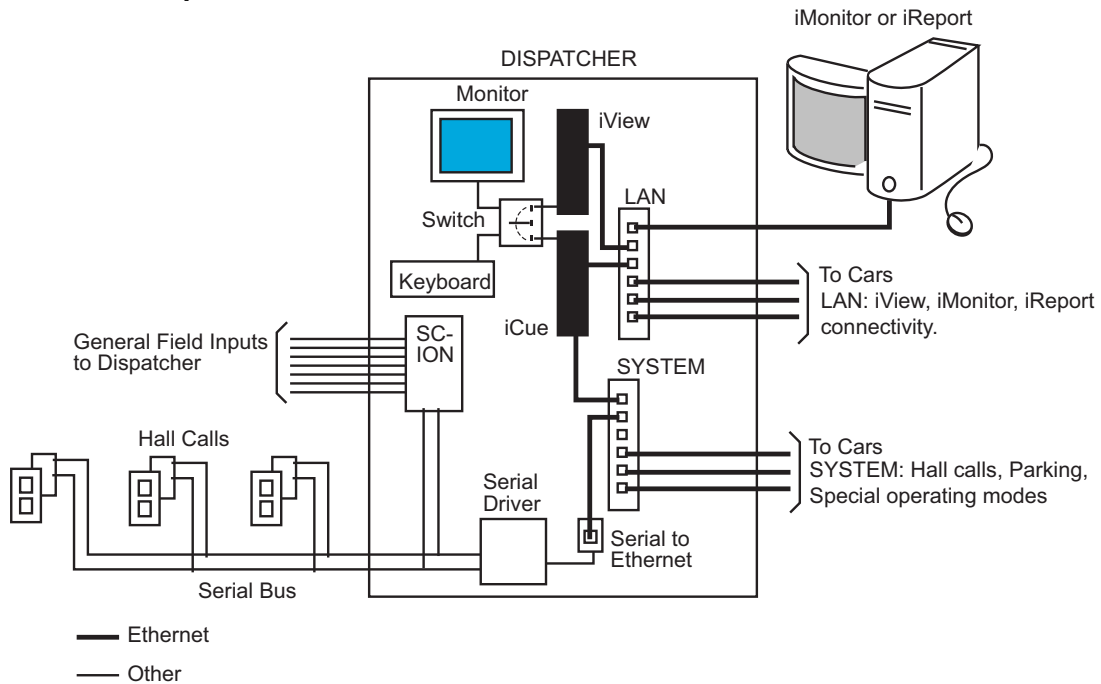


Figure 5.4 Car Control Interconnection

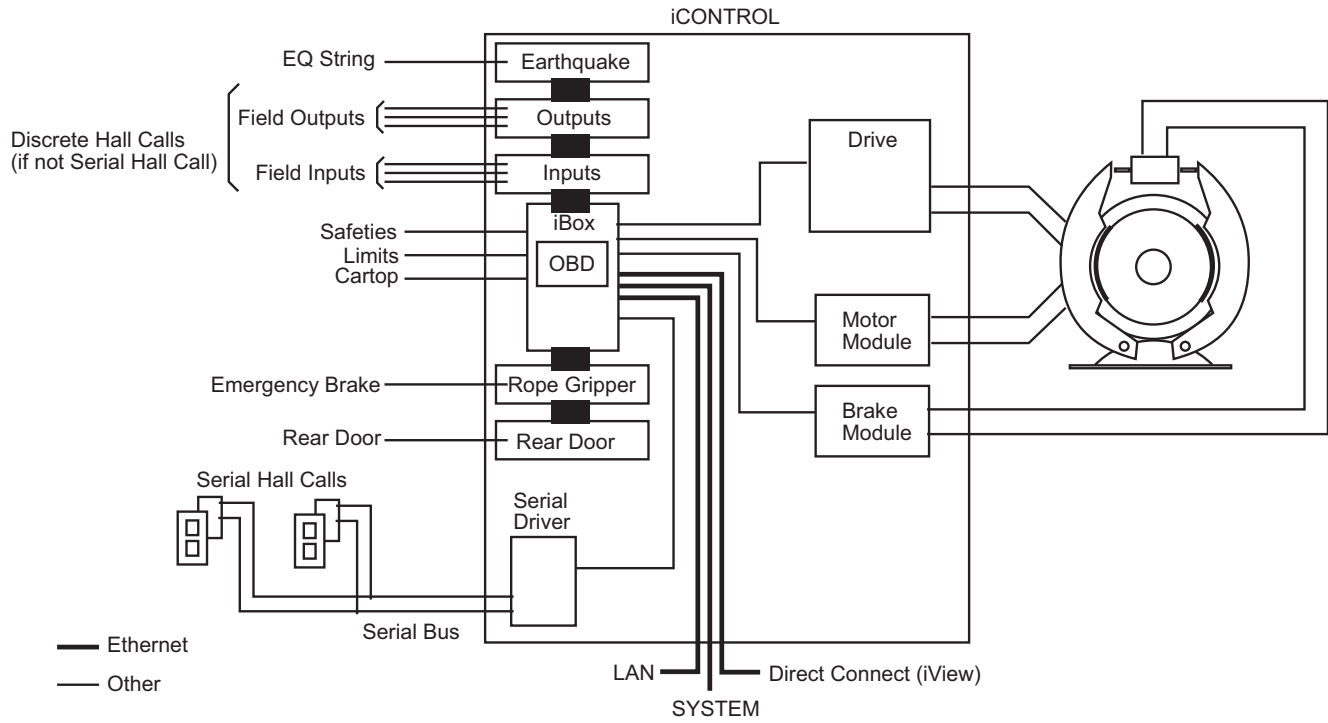
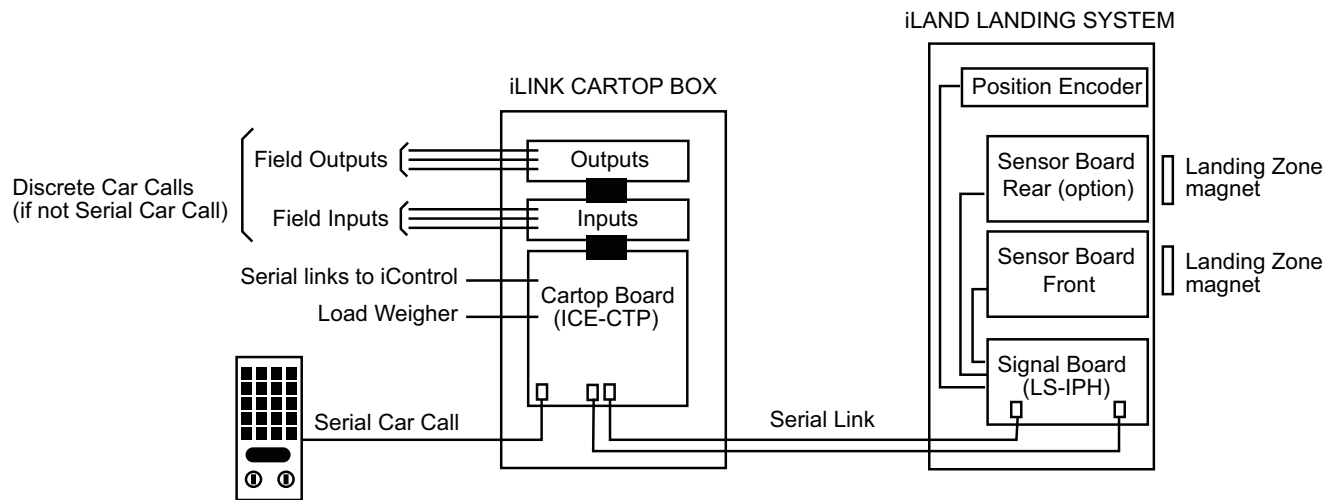


Figure 5.5 Cartop Interconnection



Cabinet Installation

Installation of the iCentral cabinet is similar to the installation of an iController cabinet. [Please refer to “Machine Room Preparation” on page 2-4.](#)

MCE Job Prints MCE job print drawing numbers use the format “Job Number — Car Number — Drawing Identifier.” Thus they are specifically “keyed” to particular installations. It makes using and understanding job prints much easier if you take some time to review the job prints package before beginning controller installation. Drawing identifiers and the information you can expect to find on that job print drawing are listed below:

- N: Nomenclature drawing — schematic symbols, wire gauge information, circuit board names and symbols.
- INT: iLink cartop wiring interconnect box to controller connections.
- CVR: iBox controls and indicators.
- 1: AC power connections, power bus information.
- 2 through nn: iBox/controller wiring.
- CC: Contact Count drawing — System contact/relay information.
- SH: Serial Hall Call wiring.



Note

Depending on your particular installation, you may have extra sheets of particular drawings. Extra sheets are indicated by an “x” following the drawing identifier. You may also have different or additional equipment in your installation accompanied by different or additional drawings in your job prints. In any case, take the time to become familiar with the job prints before beginning work. Also, It is very important that you review the wiring guidelines in this section before bringing wires into the cabinet. When drilling or cutting access holes or during other machining, do not allow any metal chips to fall into the electronics.

1. Mount cabinets securely.
 2. Route wiring as shown in the iCentral Quick Reference (document # 46-02-0208) shipped with the cabinet.
- Wires must be routed through the wiring trough provided in the cabinet.
 - All conductors entering or leaving the cabinet must be through conduit. High voltage, high current conductors, such as power conductors, must be separated from control wires.

PC boards can be easily damaged by electrostatic discharge (ESD). Use a properly grounded wrist strap or other static protection when handling, touching, or making connections to PC boards.



Grounding [Please refer to “Equipment Grounding” on page 2-14.](#)

Check for Shorts to Ground

Check for shorts to ground before powering up the system. **Power must be OFF at the main disconnect(s).** A short to ground is defined as having a resistance of less than 20 ohms between the #1 (Common) bus and the terminal being tested. If any shorts to ground are discovered, they must be corrected before proceeding.



Danger

Be certain that power is OFF at the main disconnect(s) before proceeding.

1. Using a standard screwdriver, temporarily disengage all twist-socketed fuses by turning them counterclockwise until they pop up.
2. Measure the resistance between the #2 (120VAC) bus terminals and the #1 bus.
3. If no shorts to ground are discovered, re-engage the fuses.

AC Voltage Verification and Wiring

The AC wiring instructions in this section describe connecting power wiring between the iControl elevator cabinets and the iCue cabinet. The majority of technical information is contained in the MCE job prints package and referenced here as necessary. AC voltage verification and wiring instructions include:

- Verifying main line power
- Wiring iCue
- Initial power up and test for bus voltage presence

Note

All conductors entering or leaving the cabinet must be through conduit.

1. Consult the job prints. Verify that AC supply is as specified.
2. Refer to the Group Supervisor Field Wiring Print in the job prints and to the following illustration. iCentral power is provided by the car controllers as shown in drawing -2. The main AC power supply wiring size must be determined by the electrical contractor.
 - 2a. Check the phase-offset of the individual car ST2-bus lines before connecting them to the Group cabinet. Use a voltmeter set to AC volts to measure between adjacent car 2-bus terminals in the Group cabinet. The meter must read less than 10VAC. If the reading is higher, reverse the power leads going to the car T1 transformer at L1 and L2 and measure again.

5



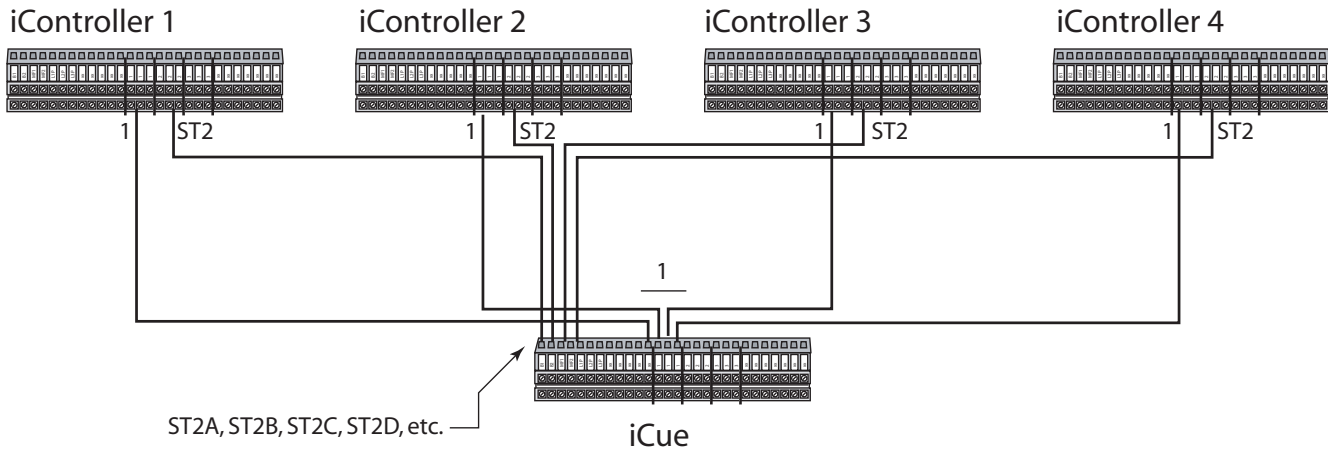
Caution

All 2 bus power from cars to the iCue cabinet must be in phase. **Connecting out-of-phase power WILL cause damage.**

- 2b. A separate conduit or trough must be provided for the System (group-to-car) Ethernet network. Wiring details in the job prints must be followed exactly.

- 2c. If applicable, also wire according to the Group Interconnects to Individual Car Cabinets print. Be sure to ground all cabinets according to instructions.
- 2d. Refer to the Group Supervisor Field Wiring Print for iCentral field wiring instructions.

Figure 5.6 Elevator Controller to iCue Cabinet Wiring



Initial Power Up and Bus Verification

After AC power is connected, you are ready to temporarily power up and check that power buses inside the cabinet are providing their proper outputs.



Caution

This procedure assumes that no field wiring has yet been connected. If field wiring has been connected, it must be disconnected before beginning this procedure. Before applying power, physically check all components in the cabinet. Components loosened during shipment may cause damage.

1. Power up the elevator controllers.
2. Power up the group controller.
3. If a controller fails to power up, refer to the job prints and check supply connections and fuses.
4. Measure from each iCue ST2 bus terminal to a Common (#1) terminal. Verify 120VAC.
5. If any bus voltage is missing, check the associated fuse. The fuses are labeled with the bus numbers and are located at the top of the cabinet.
6. Power the controllers down (in preparation to continue wiring equipment).

Note

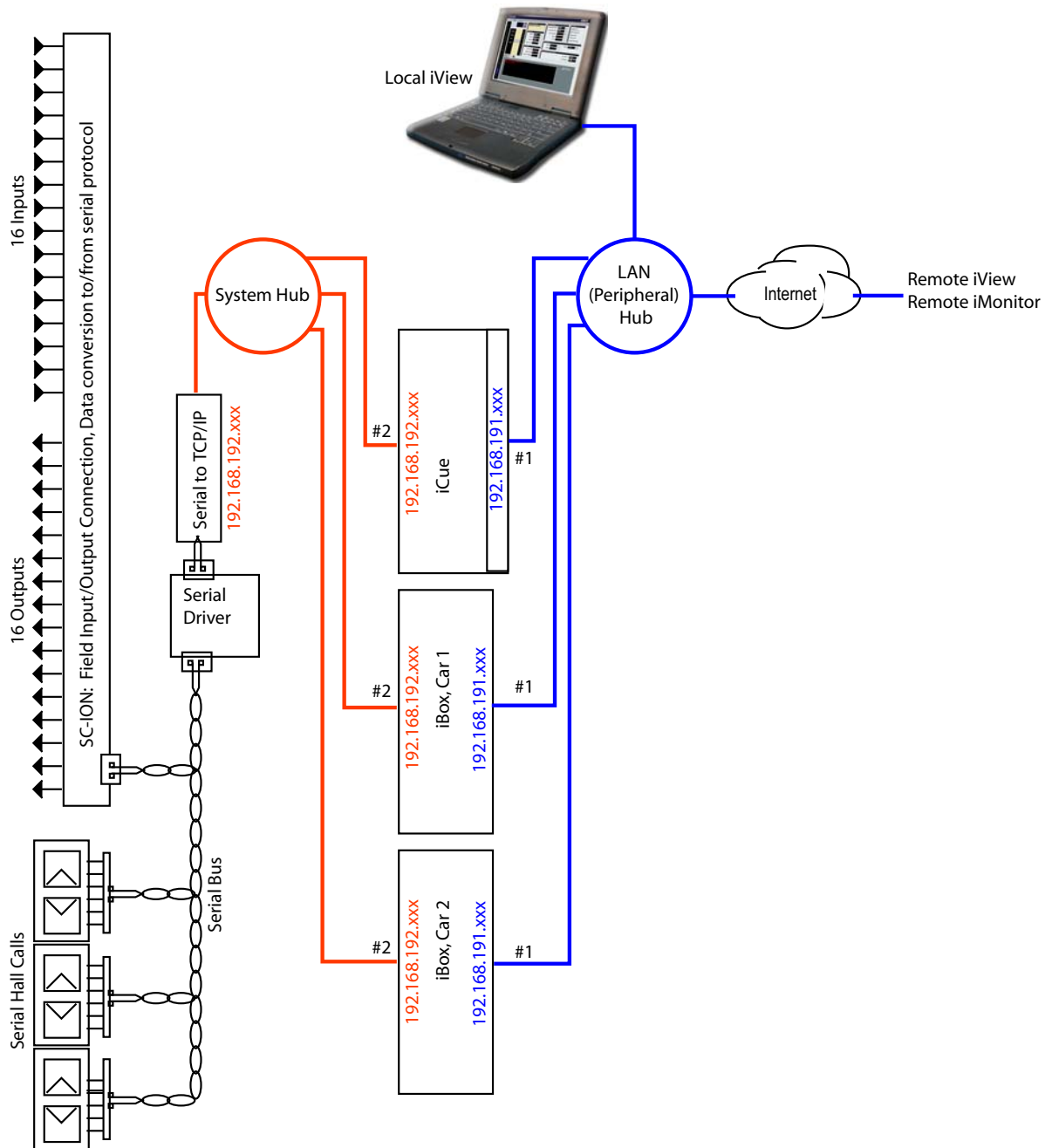
iCentral is powered from the individual car controllers so that, when any one or more of the car controllers are powered, iCentral is also powered.

iControl Ethernet Overview

iControl uses two distinct Ethernet networks:

- The System hub connects iCentral to other MCE equipment like the elevator controllers, Serial Hall Call systems, and input/output expansion boards (SC-ION boards).
- The LAN hub connects iCentral and elevator controllers to a PC running the MCE iView application (used to configure both iCentral and iControls). Through the LAN hub, the elevator group may also be connected to an external network or building LAN (Local Area Network).

Figure 5.7 iCentral Ethernet Connections



System TCP/IP

iCue uses the System TCP/IP bus to communicate with other MCE components, including:

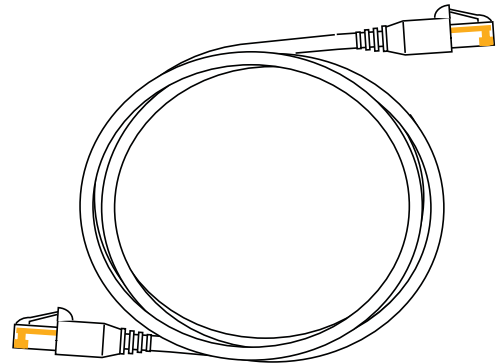
- **SC-ION I/O:** SC-ION boards provide field inputs and outputs for iCue. Customers may use these inputs and outputs for a variety of purposes. Typically, an input might be used to detect a switch closure while an associated output might drive an indicator lamp for the switch. Normally, one or two SC-ION boards, each providing 16 inputs and 16 outputs are used. If I/O demands are greater, more may be used. SC-ION boards are connected to the iCue system bus.
- **Serial Hall Call:** MCE Serial Hall Call greatly reduces the amount of hall call wiring typical of most elevator installations. The MCE Serial Hall Call bus is a simple, twisted-pair of 16AWG wires along which as many as 980 device addresses may be supported. Power and communication are both delivered by the serial bus. If current requirements are high, as many as four serial hall call drivers may be used to support the bus.
- **Serial Driver:** The current demands of the serial bus may be significant if many devices are simultaneously active. To meet these demands, each bus leg has its own Serial Driver.
- **Serial to TCP/IP:** The Serial Driver communicates with hall call nodes and ION boards over the two-wire serial bus. The serial output of the Driver is converted to TCP/IP (Ethernet) and routed through the System hub to the iCue PC. TCP/IP from the iCue PC is likewise routed through the System hub and then converted to serial data for the Driver.
- **System Hub:** The System hub is a standard Ethernet hub. The hub routes data so that TCP/IP communications between connected devices are correctly connected.
- **iControls:** Each car in the group is under the primary direction of its own iBox/iControl. iCue communicates with all the iControls in its group through the System TCP/IP bus.

LAN TCP/IP

The LAN hub allows local and remote personal computers running iView software to connect to iCue and all group iControls. The iView application is a user-friendly, graphical user interface that allows you to easily configure iCue and all the individual iControls in the group.

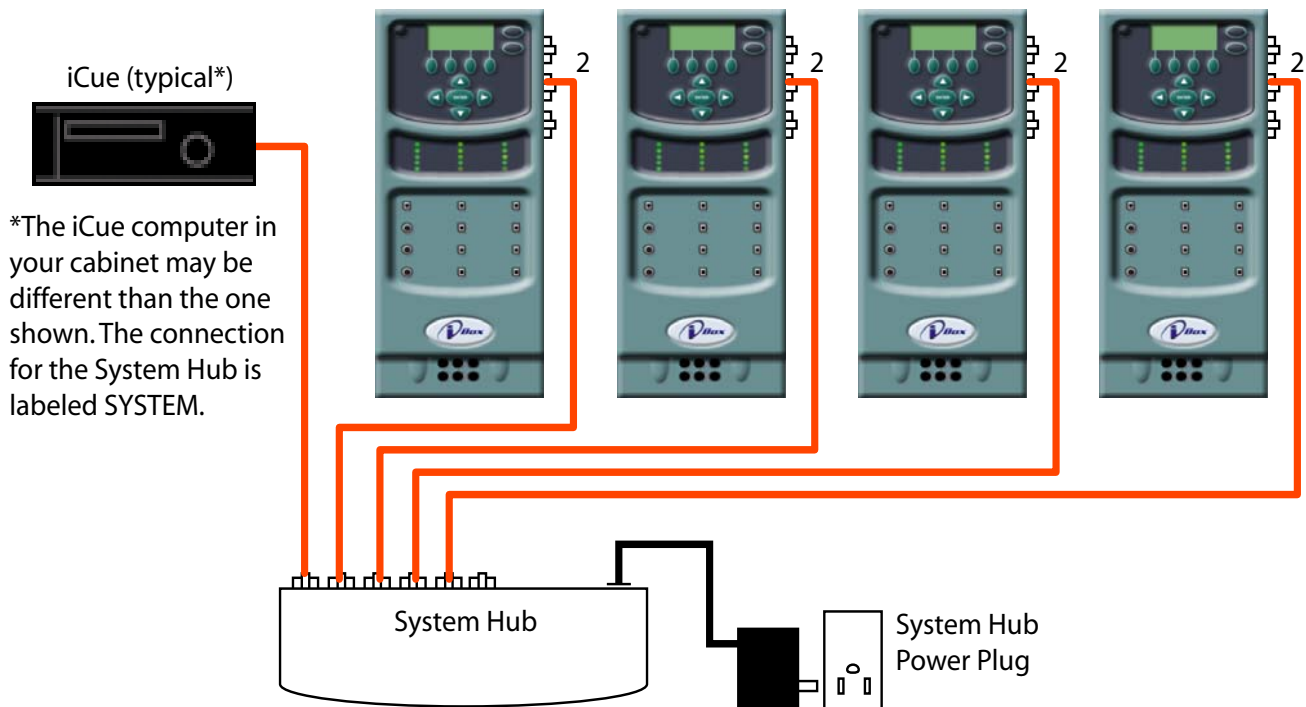
System Hub

The System hub connects iCue to the iControls in its group, to Serial Hall Call drivers through SC-HCE-ME modules, and to SC-ION input/output expansion boards. The Serial Hall Call and input/output expansion board connections are completed at the factory before the system is shipped and need only be checked to make certain they are in place. Orange Ethernet cables are used for connections to the System hub. (The LAN hub cables are blue.) The cables have a shielded RJ-45 connector at each end.



7. Connect the group and car controllers to the System hub as shown in the illustration below and in the MCE job prints. The job prints are the controlling document.

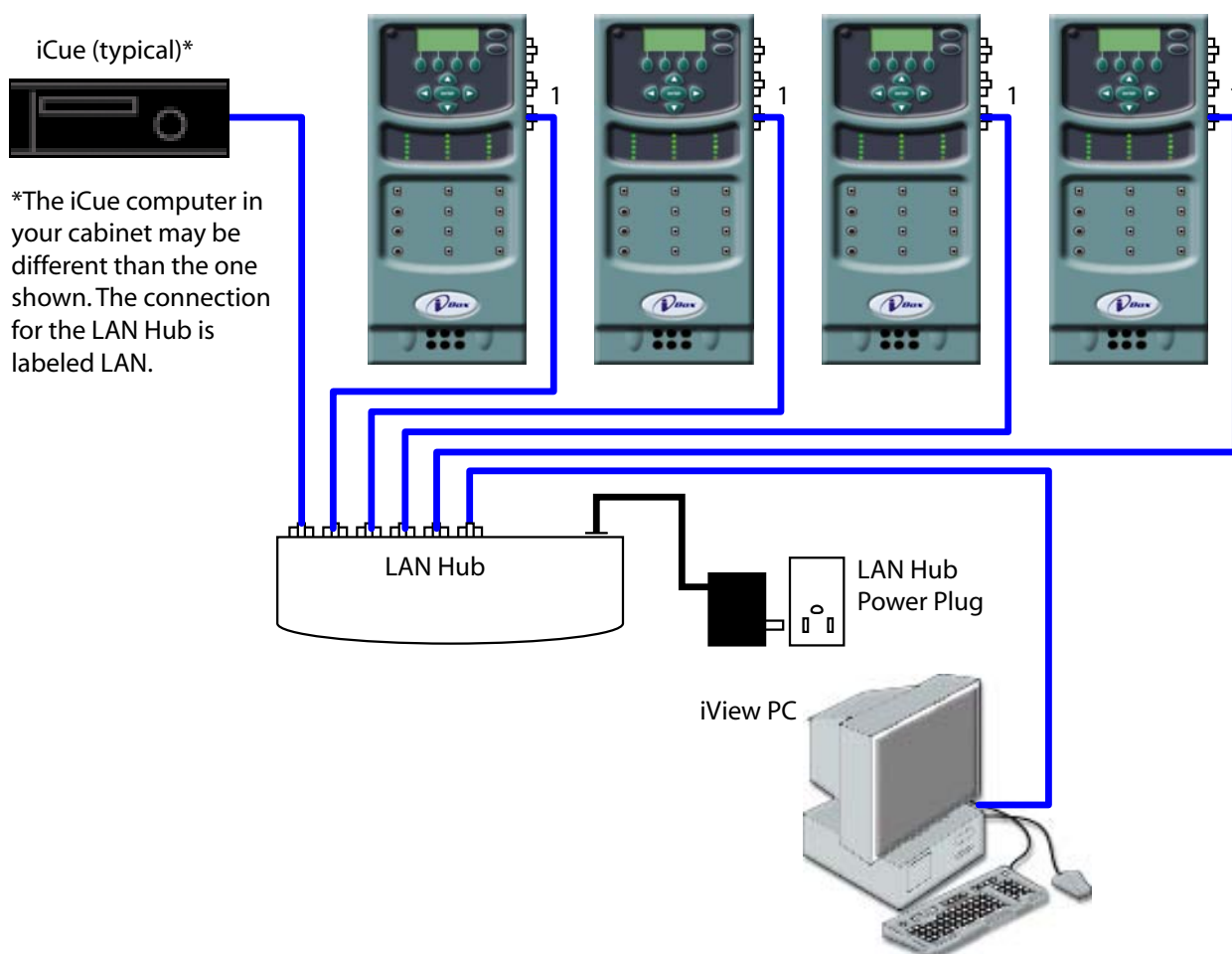
Figure 5.8 Typical System Ethernet Connections



LAN Hub

1. Connect the group and car controllers and the iView PC to the LAN hub as shown in the illustration below and in the MCE job prints. The job prints are the controlling document. Use the blue Ethernet cables provided.

Figure 5.9 Typical LAN (iView) Ethernet Connections



External Connections

As indicated in the LAN hub connection illustration, the elevator group may be connected to larger area networks in the building or, through T1, DSL, or dial-up modems, to remote sites via phone lines or the Internet. These kinds of connections are necessary if remote iView or iMonitor access is required.

Unless you are familiar with the technology, you will probably want to contact a networking specialist or consultant to help. When connecting outside the local elevator group, the installation is exposed to attempted access by unauthorized personnel. There are several different security measures that can be implemented to protect the elevator network. Additionally, if you connect the iCue LAN hub network to another Local Area Network or to the internet, you may need to change the factory-default IP addresses for the LAN connections.

Ethernet Addresses

Ethernet (TCP/IP) addresses are assigned to each device communicating on a network. Very generally, each address is a set of four, number groups separated by decimal points/periods (.). For example, 192.168.192.20. In order to see one another on a common network, the first three digits need to match for each device (192 in our example). In order to be able to tell one device from another, the last three digits need to be different. In our example, 20, so a second device would have to be any value between 1 and 254 EXCEPT 20 (already in use).

If Ethernet addresses are not properly set, the iControls and iCue will not be able to communicate. The addresses are set and tested at the factory before the system is shipped and should not need to be changed unless you are making external connections or adding new equipment.

Please refer to [“TCP/IP Reference”](#) on page 5-15 for additional information.

TCP/IP Reference

An Ethernet network is basically several computers (or smart equipment with a computer inside — like the iBox or iCue) all connected together at a single point (the hub) so they can communicate with each other. In order for a message from one computer to reach the computer (or iCue/iBox) it wants to talk to, all the computers connected to the network have to have their own unique address. The address is called a TCP/IP number.

- IP Address: #3 iBox 192.168.193.001, factory default.
- IP Address: #2 iBox, System — see table and following illustration.
- IP Address: #1 iBox, LAN — see table and following illustration.
- IP Address: iCue System port — see table and following illustration.
- IP Address: iCue LAN port — see table and following illustration.

The iCue Group ID (System Configuration screen, page 6-5) must always be set to 1. (See Note following table.) The table lists the typical addresses used for iCue elevator groups. As many as five groups can be on a single LAN provided their Group and Car LAN addresses are all unique. If desired, this is usually accomplished by connecting each of the Group LAN hubs to a sixth, user-provided hub. You can choose Group and Car LAN addresses. Car **System** addresses are controlled by the Car ID setting. The table provides the factory recommended addresses for each of up to five groups. **Your job prints provide specific instructions as to how all of your IP addresses are set.**

Table 5.1 System, LAN, & #3=PC TCP/IP Addresses

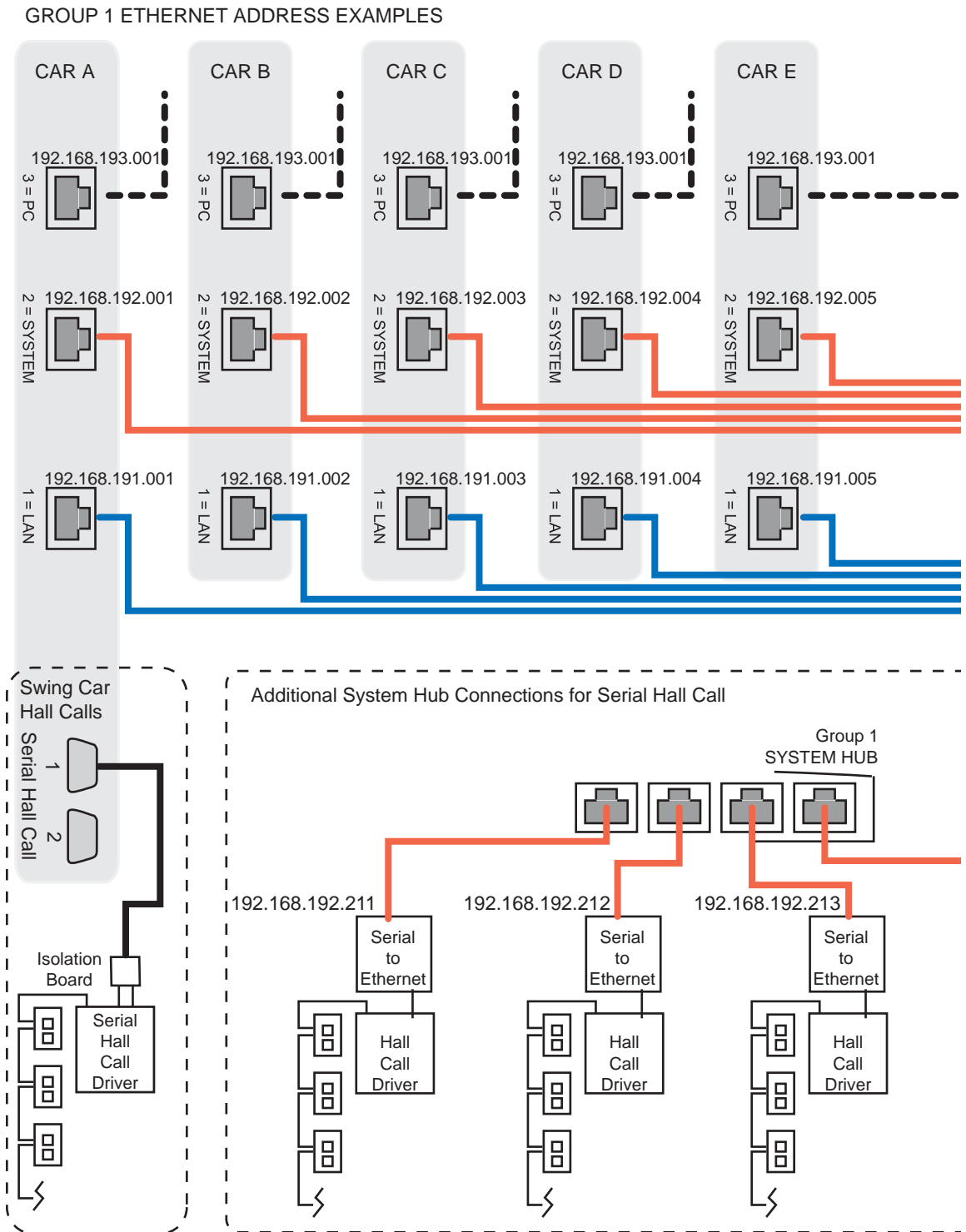
Hub	Group	Group IP Primary & Backup	Car ID	Car IP	System/Hall Call Bus 1 - 4	iView PC
System	All	192.168.192.201-202	1-20	192.168.192.001-020	192.168.192.211-214	
LAN	A	192.168.191.201-202	1-20	192.168.191.001-020		192.168.192.101-200*
LAN	B	192.168.191.203-204	1-20	192.168.191.021-040		
LAN	C	192.168.191.205-206	1-20	192.168.191.041-060		
LAN	D	192.168.191.207-208	1-20	192.168.191.061-080		
LAN	E	192.168.191.209-210	1-20	192.168.191.081-100		
Port #3 = PC (iBox ONLY), NO HUB				192.168.193.001		

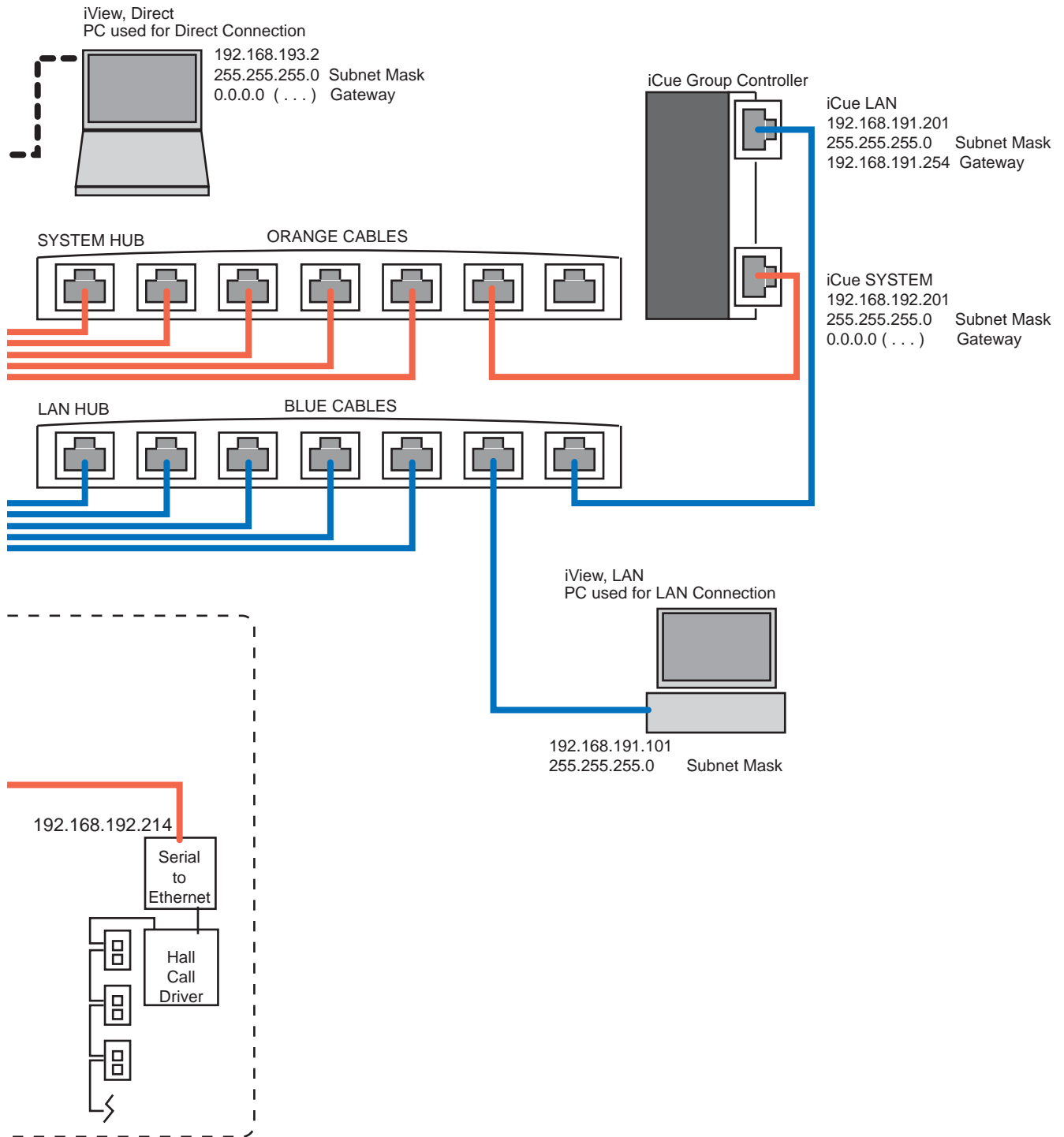
* 192.168.191.101 is typically used for the iView PC.



The Group ID setting in iView determines the iCue System IP address at which iCue will accept messages. **DO NOT set the Group ID to a setting other than 1** unless instructed to do so by MCE. The Group ID is reserved for future use. Setting it to a value other than 1 will cause group-to-car communication to fail. If you need advanced System addressing information, please contact MCE.

Figure 5.10 Example of Ethernet Addresses and Connection





System Ethernet

Only MCE equipment (iCue, iControl, MCE serial drivers) should be connected to the System hub. The TCP/IP addresses for the iBox #2 (System) and iCue System ports are set at the factory so that the systems will communicate with one another as soon as they are plugged in.

LAN Ethernet

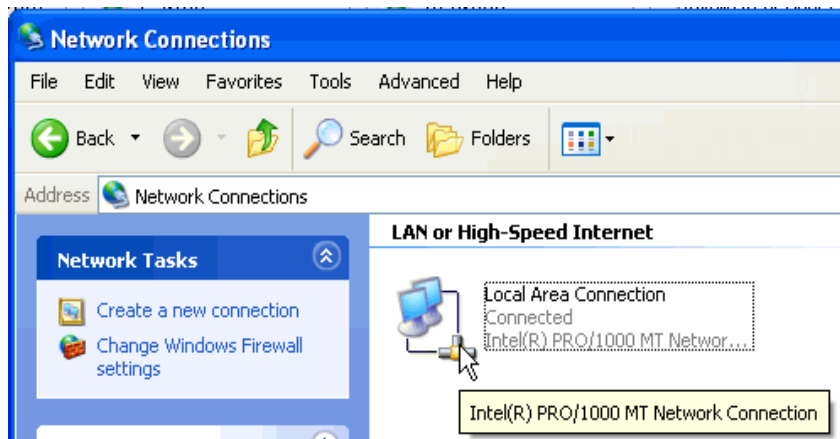
The iCue PC or iBox and the elevator controller iBoxes are also connected to the LAN hub. The LAN hub is provided so that you can connect a PC running iView, which will then be able to access all the iCue and iControl hardware connected to the hub. The TCP/IP addresses for the LAN network (iView connection) are set at the factory. If your iView PC was provided by MCE, you can simply connect the iBoxes, the iCue, and the iView PC to the hub and they are ready to communicate. However, if you provided the PC, you will need to set its IP address properly to communicate through the hub.

Setting iView PC LAN IP Addresses

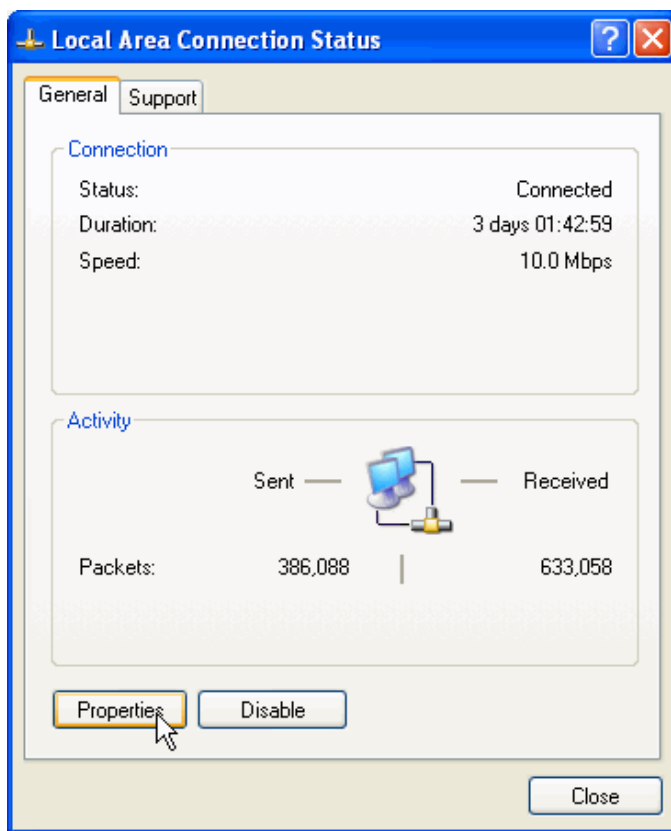
To set the IP address for an iView PC you provided and want to connect to the iCue LAN hub, use the instructions below. These instructions assume you have not changed the factory-default settings for the iCue or iBox LAN ports. When setting IP Addresses on a PC, do not enter leading zeros (i.e., .020 is entered as .20).

The following example is for the Windows XP operating system.

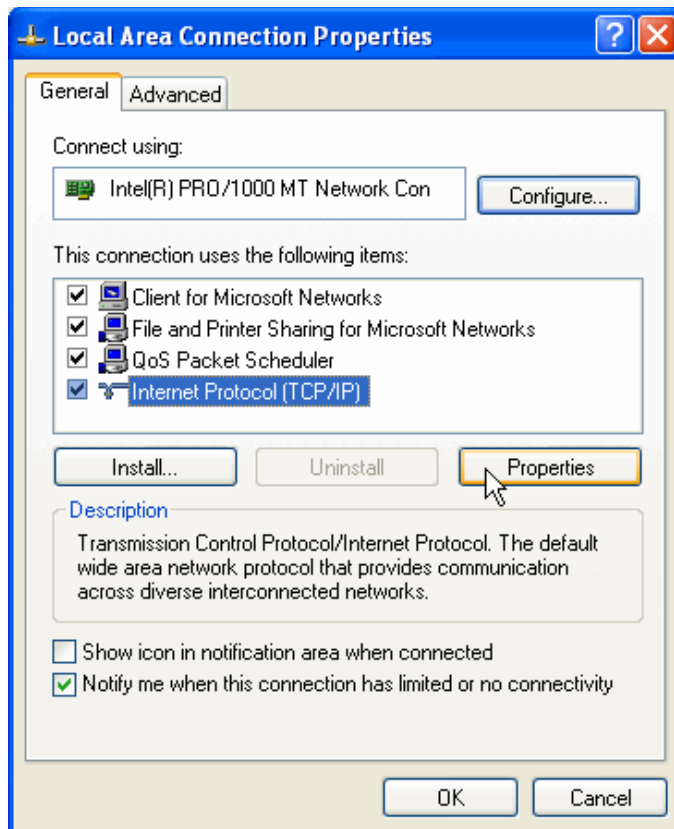
1. Start the PC.
2. Select *Control Panel* from the Windows XP *Start* menu.
3. Double-click *Network and Internet Connections* to open the Network and Internet Connections dialog.
4. Double-click *Network Connections* to open the Network Connections dialog.
5. Double-click the *Local Area Connection* icon to open the Local Area Connection Status dialog.



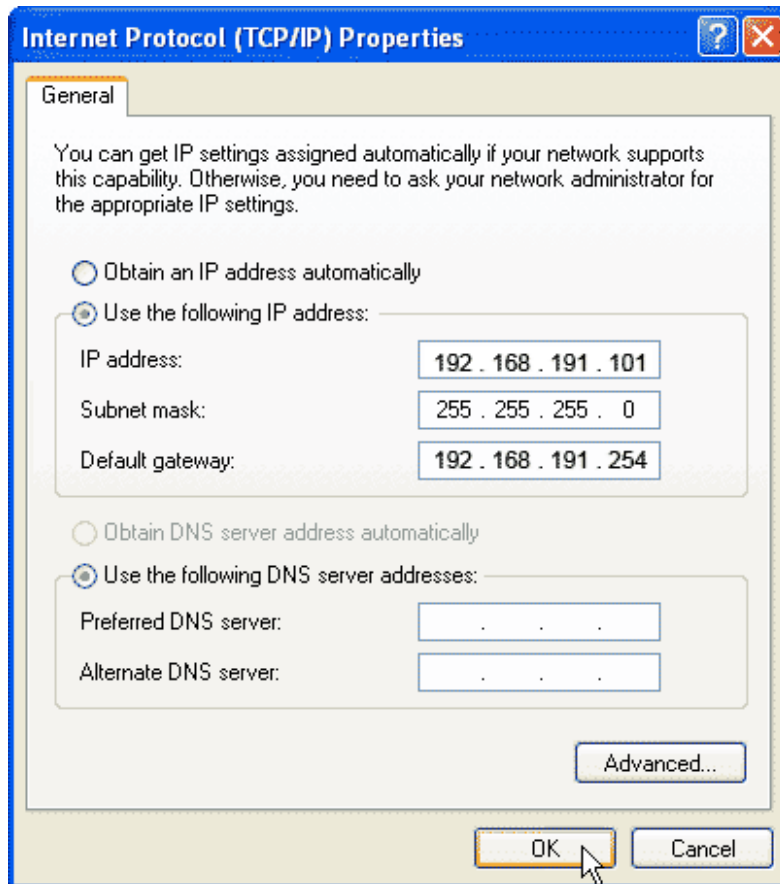
- 6. Click *Properties* to open the Local Area Connection Properties dialog.



- 7. In the Local Area Connection Properties dialog, select *Internet Protocol (TCP/IP)*.
- 8. Click *Properties* to open the Internet Protocol (TCP/IP) Properties dialog.



9. Set the IP Address to match the iCue LAN EXCEPT FOR the last set of numbers. Typically, you can set your PC's IP address to 192.168.191.101.



10. Set the Subnet Mask to 255.255.255.0.
11. Set the Default gateway to 192.168.191.254.
12. Click OK and follow any instructions to save the changes you made.

Setting iCue PC LAN IP Addresses

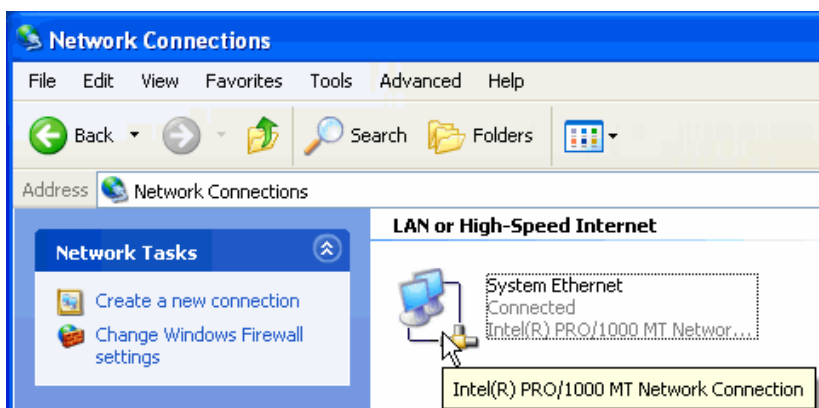
You should not need to set the iCue LAN IP address unless you are changing addresses to add the LAN hub to an existing Local Area Network. When entering IP Addresses on a PC, do not enter leading zeros (i.e., .020 is entered as .20).

Note

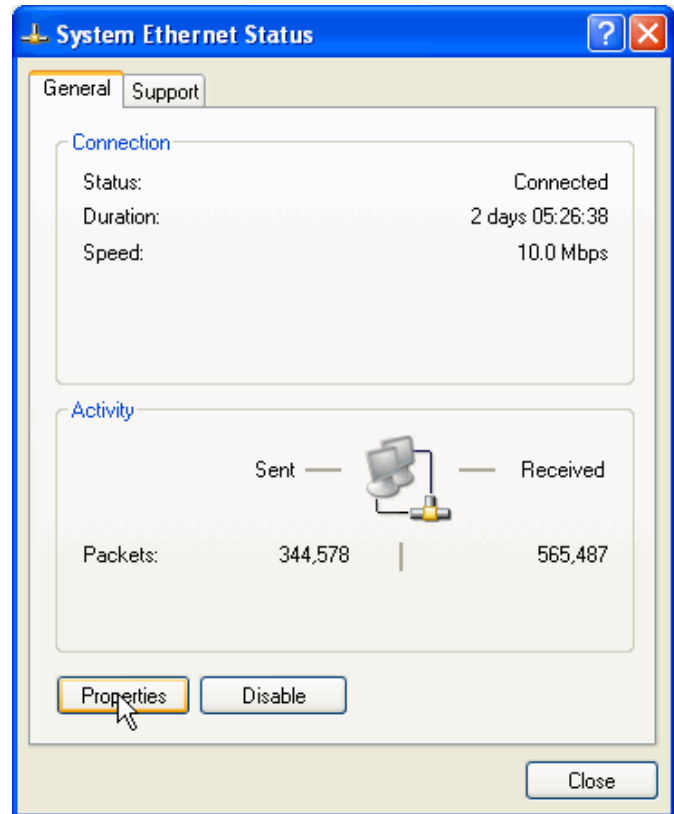
When you open your iCue PC Network Connections, you will see two local area connections. The LAN Ethernet controls the iCue LAN connection (iView); the **System Ethernet** controls the iCue System connection to iBoxes, Serial Hall Calls, and I/O boards and **SHOULD NOT BE CHANGED WITHOUT CONSULTING MCE.**

The following example is for the Windows XP operating system.

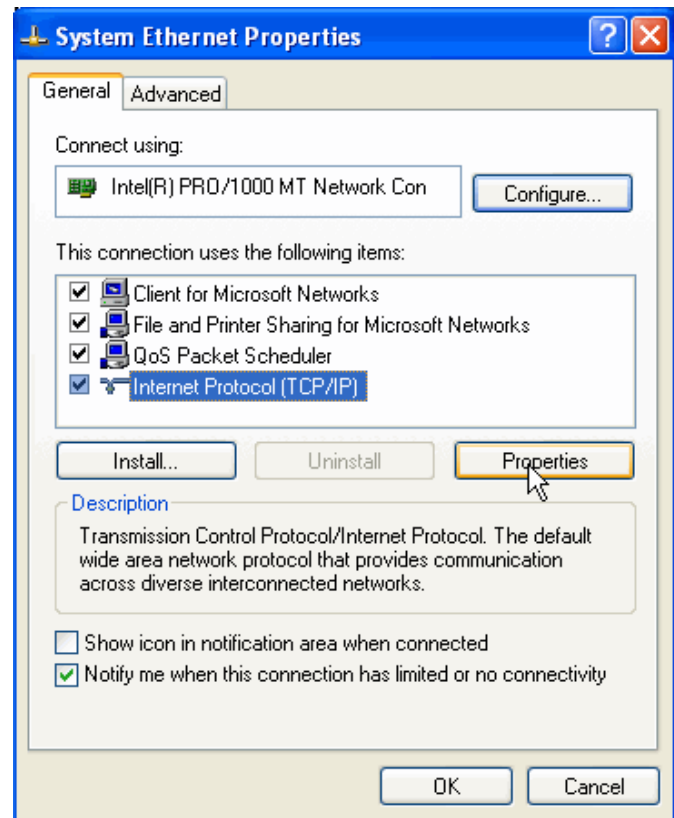
1. Start the PC.
2. Select *Control Panel* from the Windows XP *Start* menu.
3. Double-click *Network and Internet Connections* to open the Network and Internet Connections dialog.
4. Double-click *Network Connections* to open the Network Connections dialog.
5. Double-click the *System Ethernet icon* to open a System Ethernet Status dialog.



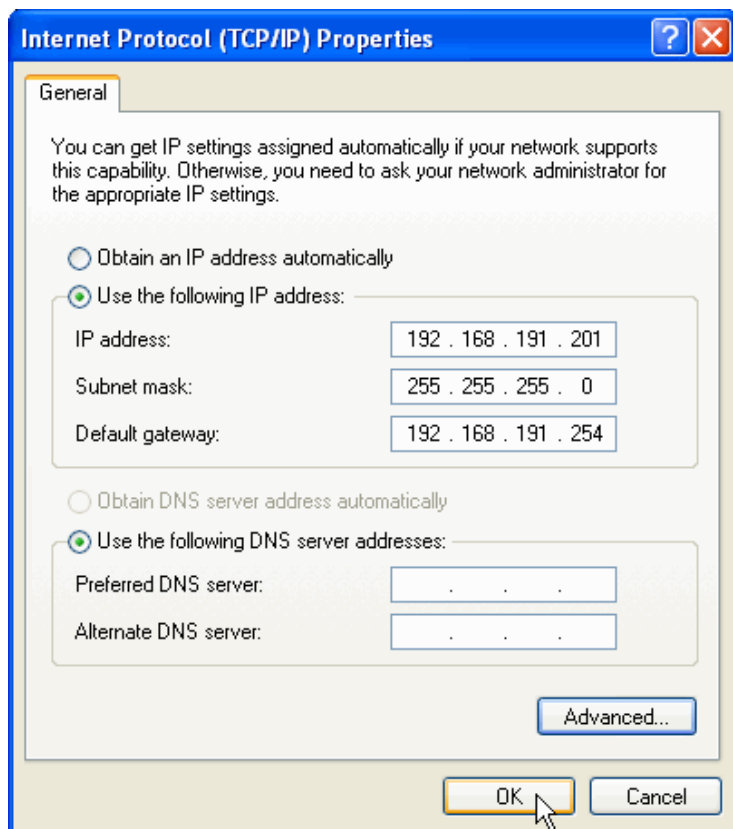
6. Click *Properties* to open the System Ethernet Properties dialog.



7. In the System Ethernet Properties dialog, select *Internet Protocol (TCP/IP)*.
8. Click *Properties* to open the Internet Protocol (TCP/IP) Properties dialog.



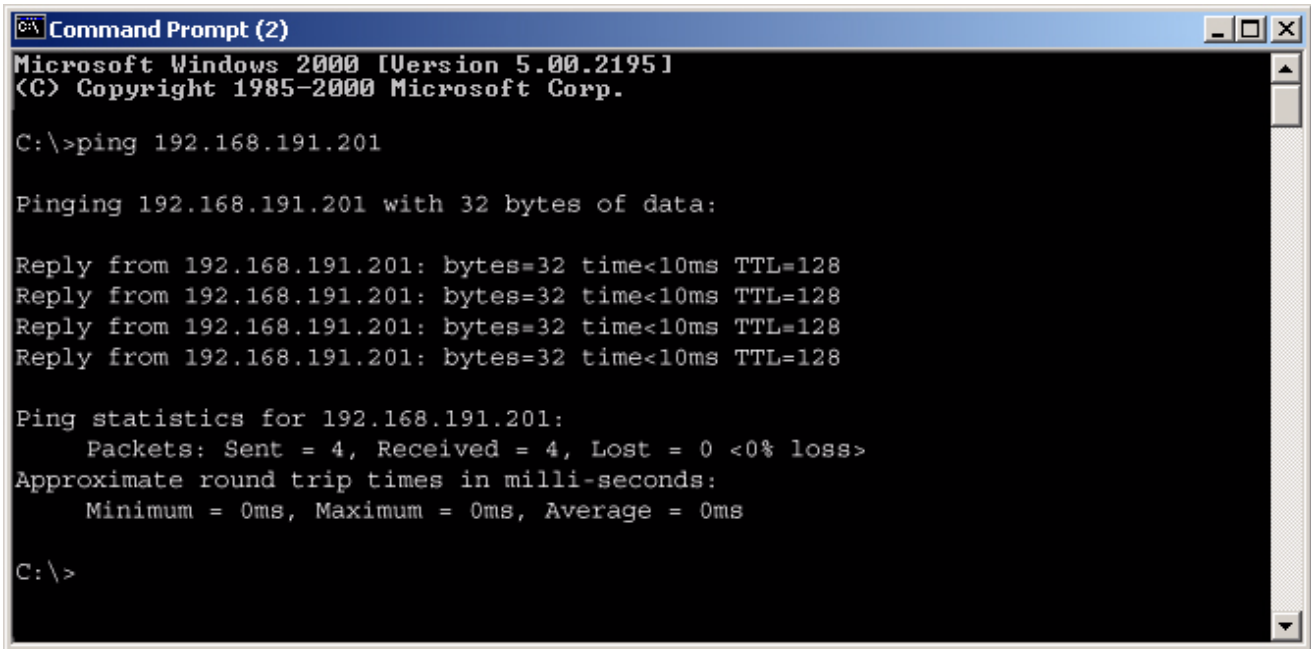
9. Set IP address, Subnet Mask, and Default Gateway accord as required to reside on the new LAN. The values shown below are the factory values.



10. Click OK and follow any instructions to save the changes you made.

Pinging

If you suspect that one or more of the devices is still not communicating, you can “ping” them from the iView PC. Pinging just lets you send a message manually that just asks for a reply if the other device can “hear” you.



To ping:

1. Select Start/Programs/Accessories/Command Prompt from the Windows Start menu.
2. Type in ping and the IP address of the device you want to check. For example:

```
ping 192.168.191.201
```

3. If the device is visible and responding, you will see four messages saying “Reply from...”
4. If not, the IP address for the PC or for the device may not be correctly set.

iCue User Interface

Whenever iCue is running and the monitor is switched to the iCue PC (rather than the iView PC), the iCue GUI is visible on the screen. The iCue GUI provides an overview of group operation and status.

The screenshot shows the iCue (01.02.26) user interface. It is divided into several sections:

- Group info:** Group ID: 1, Mode of operation: Balanced.
- LAN network info:** IP address: 10.10.52.19, Subnet mask: 255.255.0.0, Gateway: 10.10.254.254.
- System network info:** IP address: 192.168.192.201, Subnet mask: 255.255.255.0, Gateway: 192.168.192.254.
- Car connection status:** A table with 6 columns (1-6) and 1 row, each containing a red 'X' icon.
- Bus status:** A table with 5 columns (Bus 1-4) and 6 rows (Connected, Bus voltage, Driver VDC, Node control, Bus enabled, High current). Connected, Bus voltage, Driver VDC, and Node control are green; High current is red.
- Emergency power:** Generator 1 and Generator 2 are both green.
- Write privilege timeout:** Timeout: 15 min, with a Send button.

At the bottom, there is a navigation bar with a double arrow icon, the number 0, and the MCE logo.

5

- **Group Info**
 - **Group ID:** Must always be set to 1. This setting is reserved for future use. Setting it to a value other than 1 will cause iCue-to-iBox communication to fail. Call MCE if you have questions.

- **Mode of Operation:** The current group operating mode is displayed here:
 - **Automatic:** The group assigns operating modes automatically depending upon building traffic conditions.
 - **Balanced:** The group is operating in balanced mode, favoring neither up, down, nor lobby traffic.
 - **Lobby Peak:** The group is operating in lobby peak mode, favoring traffic from the building lobby or lobbies.
 - **Demand Up Peak:** The group is optimizing car assignment to favor up direction traffic.
 - **Demand Down Peak:** The group is optimizing car assignment to favor down direction traffic.
- **Network Info (LAN and System):** The LAN is the ethernet network used by iView, iMonitor, and iReport to communicate with groups and cars. The System is the ethernet network used by the group and individual car controls to communicate with one another.
 - **IP Address:** The TCP/IP address of the group on this network
 - **Subnet Mask:** The subnet mask limits the number of valid addresses in the group. For iControl, this should always be 255.255.255.0
 - **Gateway LAN:** 192.168.191.254
 - **Gateway System:** 000.000.000.000 (o.o.o.o)
- **Connection Status:** Displays the active car connections.
- **Bus Status:** For each serial I/O bus (1, 2, 3, 4), displays operational status:
 - **Connected:** Lights green if the bus is connected.
 - **Bus Voltage:** Lights green if the bus voltage levels are adequate.
 - **Driver VDC:** Lights green if the DC voltage provided by the driver is adequate.
 - **Node Control:** The driver polls the nodes (addresses) of connected devices (hall calls, other I/Os). This LED lights green when all nodes are responding correctly.
 - **Bus Enabled:** Lights green when there is activity on the bus.
 - **High Current:** Lights red if current demand is excessive. Occasional flashing is normal. Near continuous flashing or steady on state means that the serial driver is unable to provide enough current to meet demand. Continued high demand can damage the bus driver. Contact MCE Technical Support.
- **Emergency Power:**
 - **Generator 1:** Commercial power has been interrupted. Generator 1 is functioning.
 - **Generator 2:** Commercial power has been interrupted. Generator 2 is functioning.
- **Write privilege timeout:** Allows you to set the amount of time for which write privilege is granted. The default is 15 minutes. A value of zero = no time out.

Write Permission

When someone working in iView wants to change an iCue setting, they have to request permission by selecting Acquire from the Write Privileges menu. When they do, a pop-up dialog will appear on the iCue screen in which you can approve or deny the request. This prevents remote iView connections from making changes without the permission of machine room personnel.

If you request permission from the iCentral iView PC, immediately switch to the iCue PC by pressing <scroll lock> twice and approve the request in the pop-up dialog. Then switch back to the iView PC to make the changes.

iCue Watchdog

When iCue is running, there is a utility called iCue Watchdog running in the background. The watchdog monitors iCue and makes certain that it continues to run as it should.

The watchdog is a Windows Service, which means that it will not show up on the task bar or icon tray. It runs under the name iCueWatchdogService.exe. Some attributes of the watchdog include:

- The watchdog's purpose is to make sure iCue is running. If iCue is closed through the task manager, crashes, or locks up, the watchdog will restart it.
- The watchdog will also monitor the iCue GUI. It will restart the GUI if it crashes for some reason. This should have no effect on iCue or system dispatching.
- The watchdog should always be running whether iCue is running or not. It gets started in a batch file that is put into the startup directory.
- If you close the iCue GUI (by right-clicking it in the icon bar and selecting exit) the watchdog assumes that is done intentionally and will not restart icue.
- Starting the iCue GUI after it has been closed will trigger the watchdog to start monitoring the applications again.
- The watchdog has a config file for setting the directory paths of iCue and iCue GUI and timers (in msec) that it uses to monitor the applications.



Caution

Watchdog information is provided to help you understand how iCue works. **Never** attempt to modify Watchdog configuration. Incorrect settings can corrupt the functionality of the iCue group control software.

Comm-connect Cabinet - Local/Dispatcher

The Comm-connect cabinet is used to house the system communication components when the Local/Dispatcher option is used. This cabinet houses the Serial Hall Call Driver(s), Ethernet Switches, SC-ION Serial Control I/O Node board and AC power connections.

Figure 5.11 Typical Comm-connect Cabinet

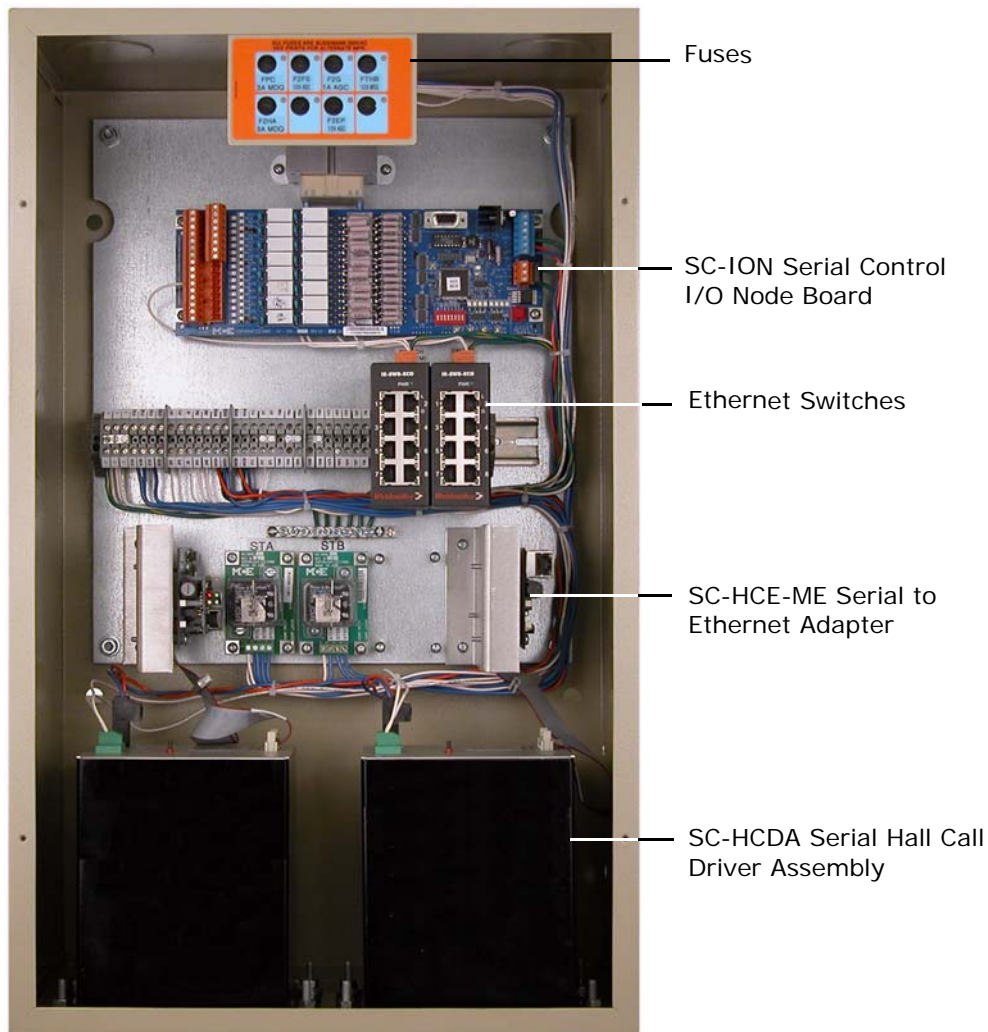
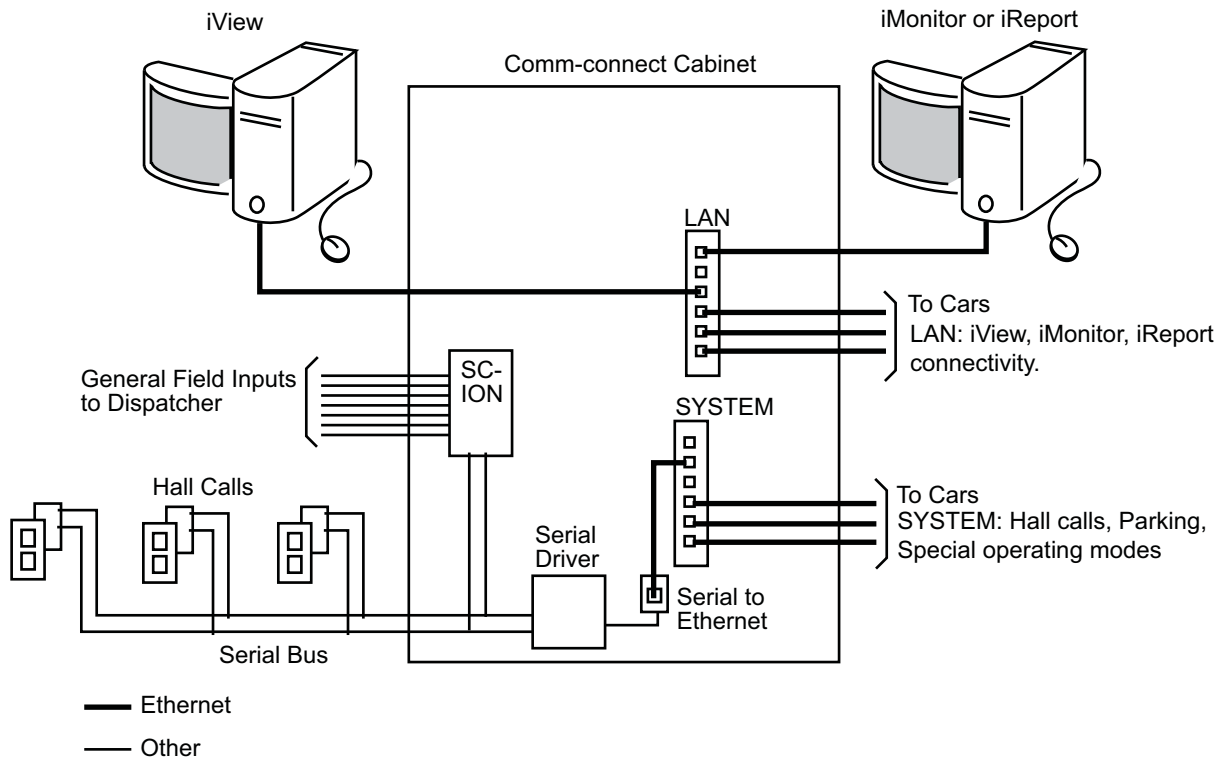


Figure 5.12 Comm-Connect Interconnection



For systems that use the Local/Dispatcher option, the Comm-Connect Cabinet is where the serial and Ethernet communication equipment is housed and where the connections are made.

- **Ethernet Switches:** The Ethernet switches are the main connection / distribution point for the Local Area Network (LAN) and System Ethernet networks.
- **SC-HC-ME Serial to Ethernet Adapter:** This component converts the serial signals from the SC-HCDA Serial Hall Call Driver Assembly to the Ethernet protocol for transmission on the System Ethernet network.
- **SC-HCDA Serial Hall Call Driver Assembly:** This assembly provides power and communication to the Serial Hall Call Node boards located in each hall fixture box. Power and communication is transmitted on the two wire Serial Bus. Two SC-HCDA assemblies may be housed in the Comm-connect cabinet. For more information about the Serial Hall Call option see [“Serial Hall Call” on page 5-30](#).
- **SC-ION Serial Control I/O Board:** This board is used for serial communication of signals other than hall call signal (see [“Checking Serial to IP Connections” on page 5-35](#)).

Serial Hall Call

Direct serial I/O allows hall call buttons/indicators, to be connected to iControl using a simple, 2-wire bus for both communication and power. This serial bus reduces the amount of wiring required per riser and makes the wiring job much easier and less expensive.

The serial bus uses a +/- 15-volt square wave, sampled for both amplitude and duty cycle, for communication between devices. The positive-going signal actually reaches +40-volts and is regulated to +24-volts to drive hall call lamps or other loads.

A “bus driver” is required to provide the output capability necessary to carry the load of multiple, simultaneously lighted lamps. A single controller can have up to four drivers/serial buses with each bus addressing as many as 980 devices. The photograph below shows a serial hall call bus driver installed in an iCentral Controller cabinet.

Figure 5.13 Serial Hall Call Bus Driver

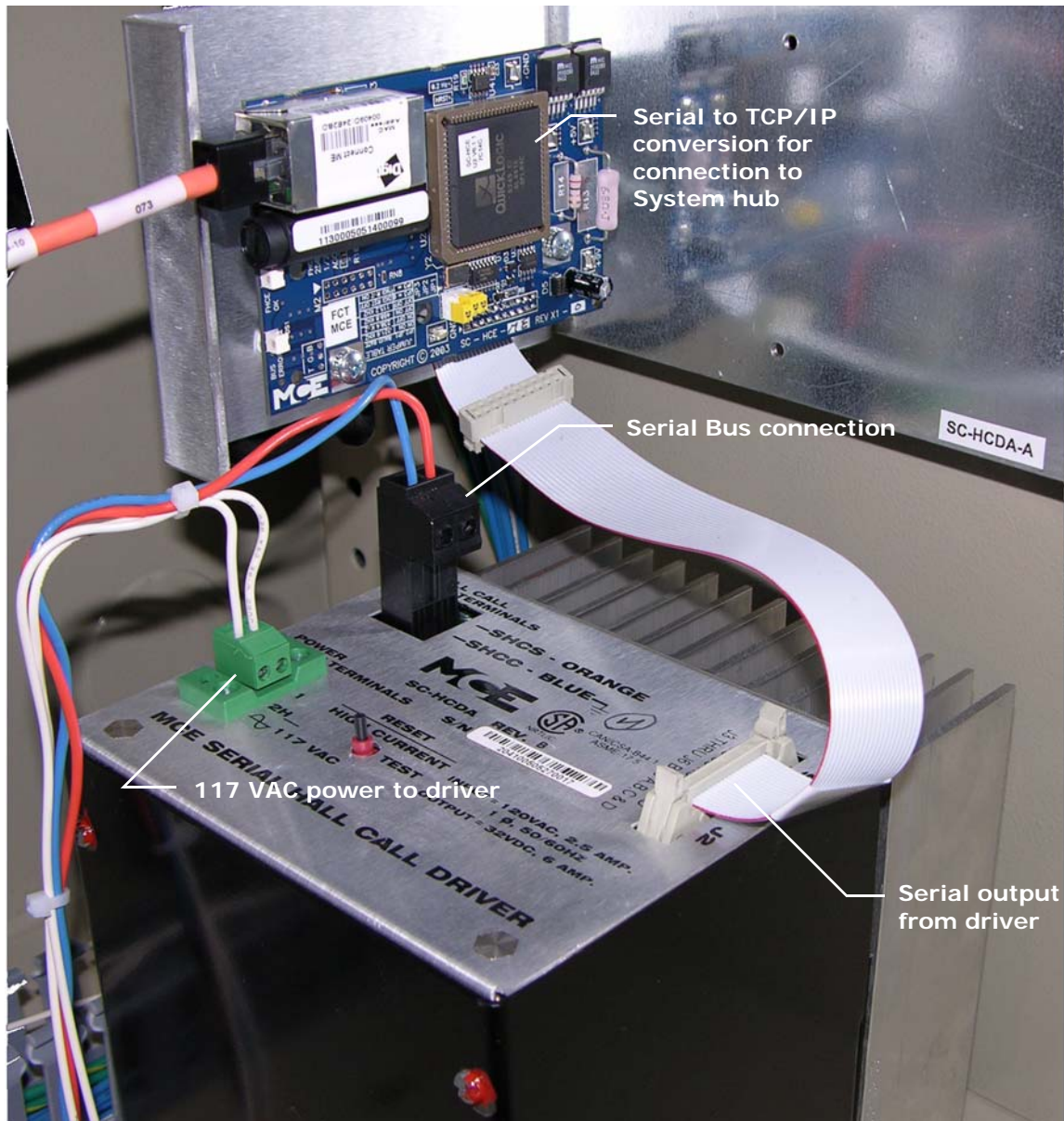


Figure 5.14 Typical iCentral Serial Hall Call Connections

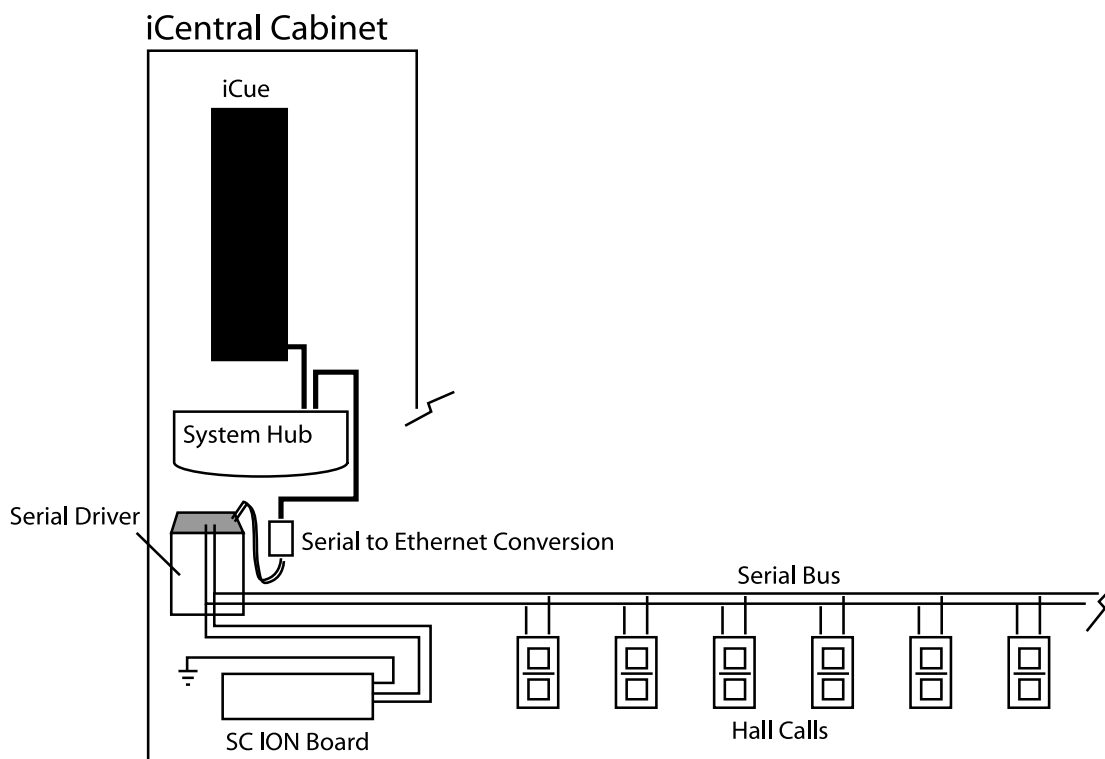
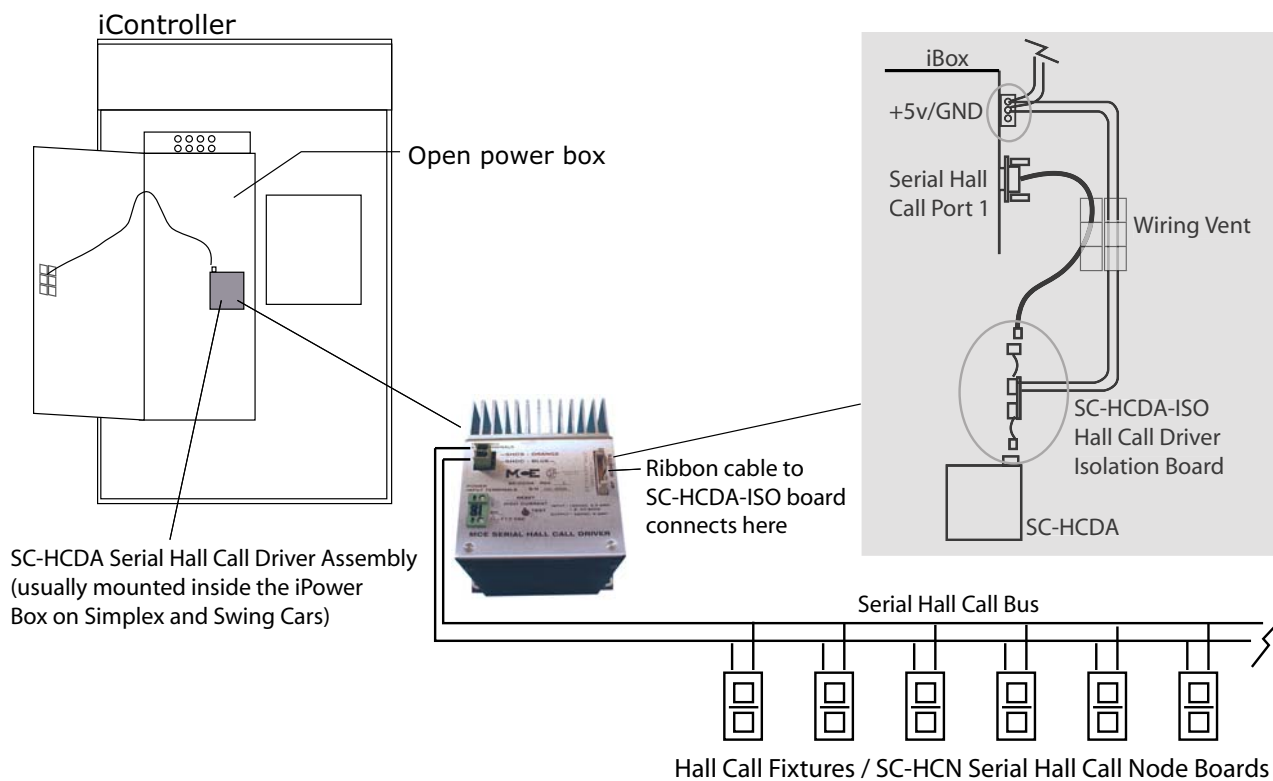


Figure 5.15 Typical Serial Hall Call Connections for a Simplex or Swing Car



Hall Call Installation

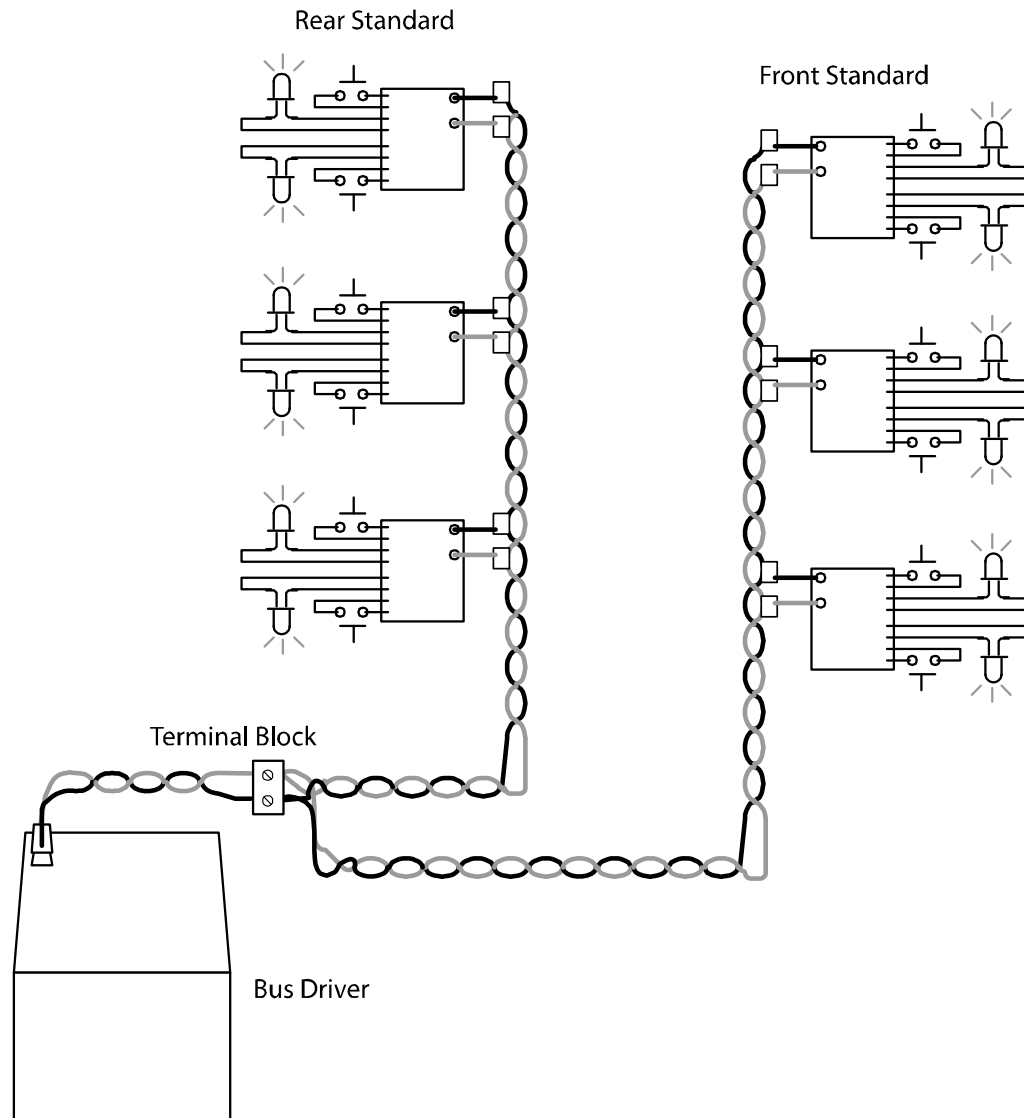
Installing a serial hall call system includes:

- Pulling the serial bus wiring
- [Setting the node board addresses](#)
- Installing the hall call enclosures (refer to the job prints)

Pulling Serial Bus Wiring

The serial bus is the physical, twisted pair of 14 AWG or 16AWG wires along which all the hall calls are connected. Install the serial bus wiring in accordance with applicable codes. The best practice is to initiate each separate vertical bus wire run from the controller location. If necessary, multiple serial bus runs can be “paralleled” at a driver to make them a single serial bus. Refer to the drawing “Serial Hall Call Suggested Wiring Methods” in the job prints for specific instructions for each job. The illustration below shows a single serial bus connected to serve two vertical runs of hall call boxes.

Figure 5.16 Single Bus, Two Vertical Runs of Hall Call Boxes

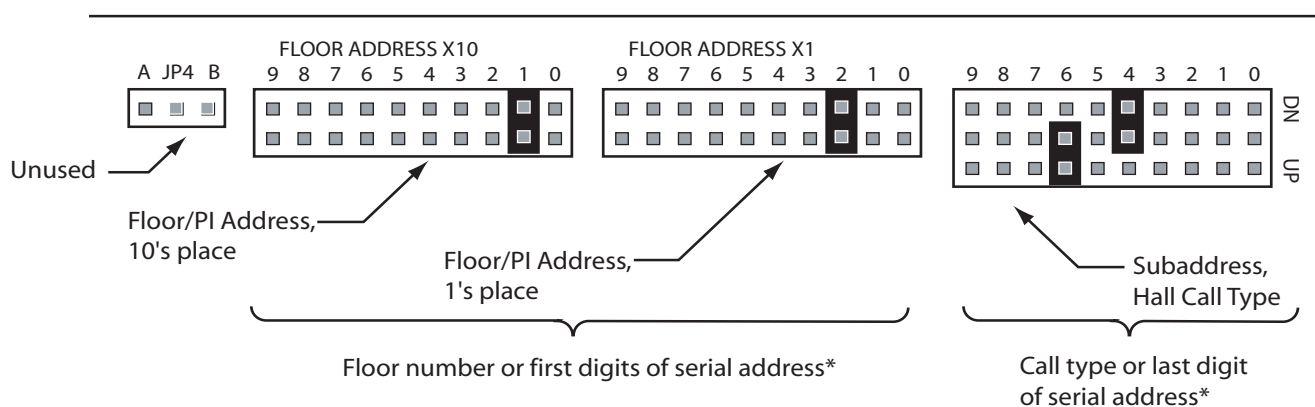


Setting Node Board Addresses

Each hall call enclosure contains a “node” board. The node board provides two outputs to power hall call lamps or LEDs, two inputs for the hall call buttons, and jumpers to set floor ID and hall call “type.”

In a typical installation, a node (HCN) board is mounted in each hall call receptacle. The blue and orange wires of the serial bus connect to one end of the board, the hall call buttons and lamps or LEDs connect to the other end (as shown in the job prints depending upon lamp or LED connection). During installation, it is easiest to set jumpers on each node board so that it is uniquely identified for floor ID and call type before you mount the board in the enclosure.

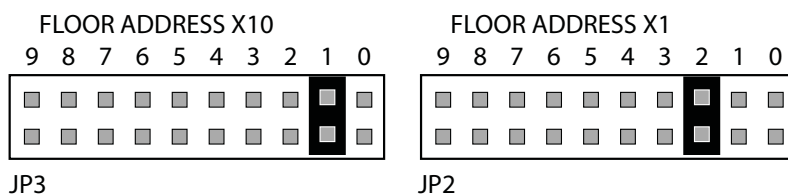
Node board jumper examples are illustrated below.



* This example sets the Down (DN) input/output to address 124 and the UP address to 126. The first two digits represent the floor number, in this example, 12.

- **Floor Number/Address Jumpers**

Jumpers 2 and 3 set the Floor number (or the first two digits of the serial address) for the node board.



Jumper 3 sets the first digit for the floor (or serial address).

Jumper 2 sets the second digit for the floor (or serial address).

The example shown above would set the Floor number to 12.

Because building floors are not consistently numbered and because a riser may not serve all floors in a building, MCE creates a table of values for these jumpers according to the building survey for the job. Refer to your job prints for precise information about setting these jumpers for your installation.

- **Call Type Jumper**

Jumper JP1 sets the call type for the two switch/lamp combinations serviced by the node board (or the individual jumpers can be thought of as setting the last digits of the boards two unique serial addresses). You set one jumper for each of the boards two I/Os. The most common setting for JP1 jumpers, Down Front and Up Front hall calls, is shown in the following illustration. The table after the illustration lists all call types.

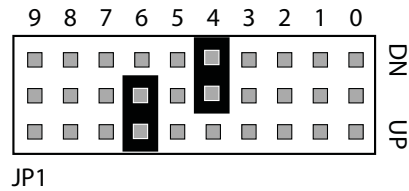


Table 5.2 Floor Sub-Addresses (Call Type) Jumper Settings

Sub-Address	Default Definition	Sub-Address	Default Definition
0	Front Auxiliary Down Call	5	Standard Rear Down Call
1	Rear Auxiliary Down Call	6	Standard Front Up Call (shown)
2	Front Auxiliary Up Call	7	Standard Rear Up Call
3	Rear Auxiliary Up Call	8	Commandeer Front Call
4	Standard Front Down Call (shown)	9	Commandeer Rear Call



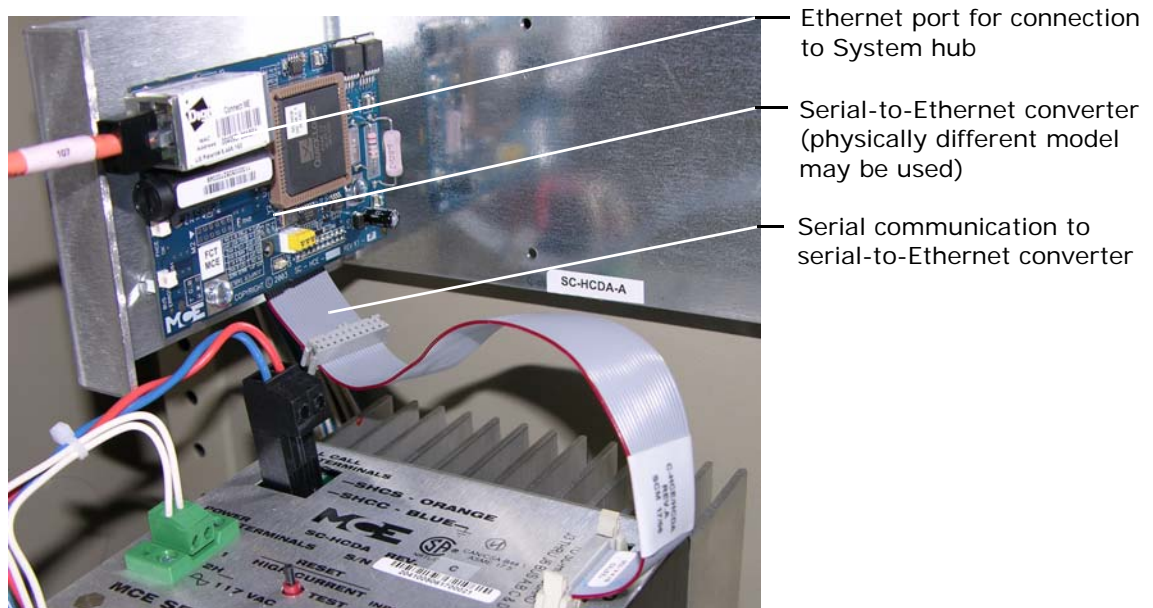
Only the Sub-address jumper, JP1, can have more than one jumper inserted. (It can have a maximum of two — one to complete the DN address, the other to complete the UP address.) All other node board jumpers can have ONLY ONE jumper inserted. If more than one jumper is inserted in JP2 or JP3, the system will not work.

Wiring the Nodes Each serial bus consists of a twisted pair of wires, one orange and one blue. Each “node” on the bus (i.e., a hall call button/lantern pair), has a connection to the orange wire and a connection to the blue wire in addition to button and indicator lamp connections. See the job prints and instructions accompanying the hall call kits for details.

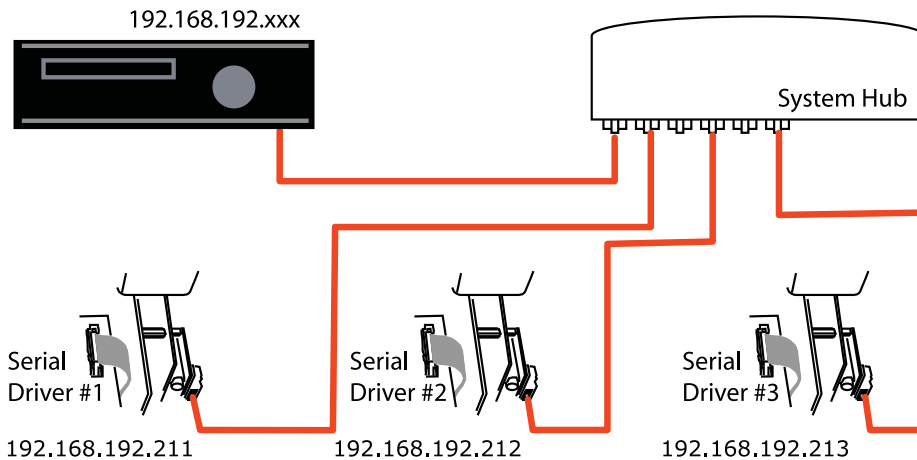
Checking Serial to IP Connections

Each Serial Hall Call bus originates from a Serial Hall Call Driver in the iCue cabinet. Each Serial Hall Call Driver in turn communicates with iCue through the System Ethernet hub.

Figure 5.17 Serial to TCP/IP Connection



1. Verify an orange Ethernet cable from the Serial-to-Ethernet converter to the System hub.



The Serial-to-Ethernet converters each have their own IP address. The IP address is preset at the factory and should not need to be changed.



Caution

Always power down the serial hall call driver and wait at least one minute before installing, replacing, disconnecting, or connecting an SC-HCME-EM or -ME serial to Ethernet board to avoid potential damage to the board PLD from a high voltage spike.

Troubleshooting

This section describes some basic troubleshooting techniques for the serial/Ethernet translation units (Digi boards) and the Serial Hall Call Driver Assembly (SC-HCDA).

Serial/Ethernet Translation

The serial I/O protocol used for MCE serial hall call and serial I/O board connections is translated to and from Ethernet bus protocol for system level communication over the iControl System network. (System hub in iCentral dispatcher. Orange TCP/IP cables.) One of two assemblies is used:

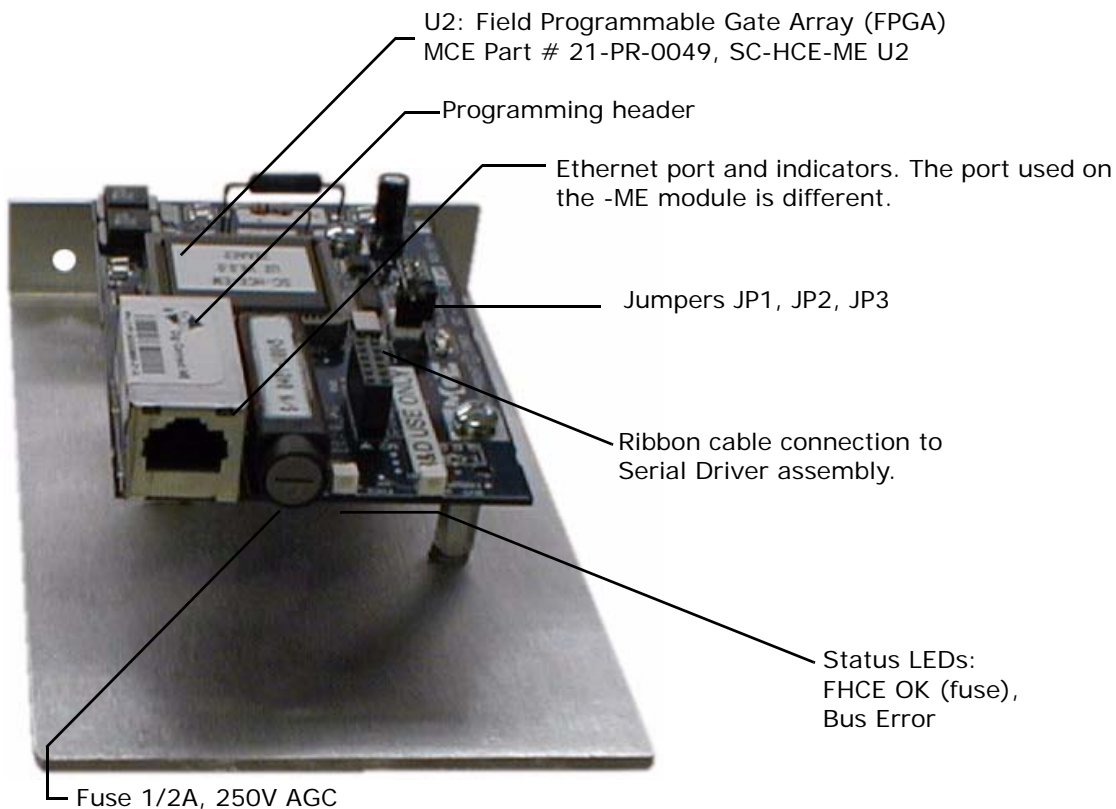
- SC-HCE-ME
- SC-HCE-EM

The base circuit board is the same for both units. The Ethernet port module used is different. These assemblies are mechanically configured, then programmed using a special utility program running on a Windows 2000 or XP personal computer.

SC-HCE Assemblies

The SC-HCE-ME assembly is shown in the illustration below.

Figure 5.18 SC-HCE-ME Serial/Ethernet Translation Assembly



Mechanical Configuration Refer to the preceding illustration for part identification.

- **Ethernet Port:** Standard Ethernet port. Used to connect this assembly to the System Ethernet hub using an orange Ethernet cable.

Figure 5.19 -EM and -ME Ethernet Ports

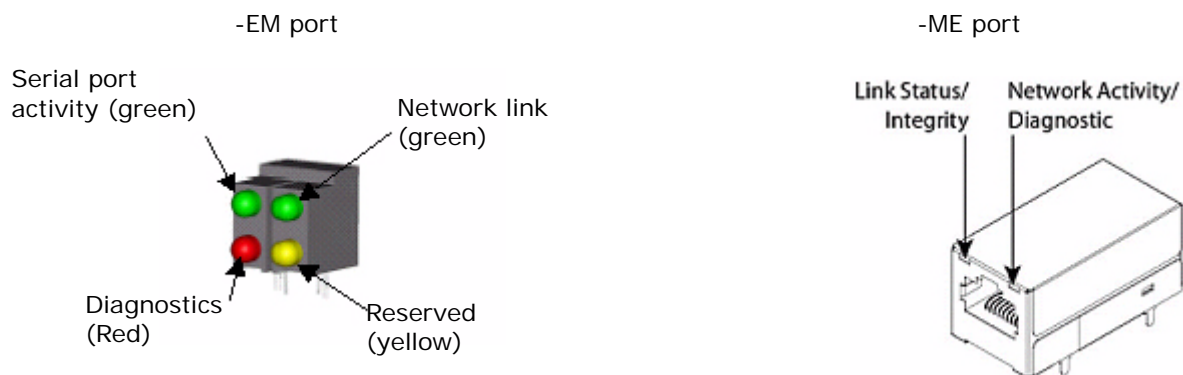


Table 5.3 EM LED Descriptions

LED	Color	Function	Description
Serial port activity	green	Indicates activity on the serial port	Off: serial channel idle. Blinking: Active connection.
Network link	green	Network link status.	Off: No link detected. On: Link detected.
Diagnostics	red	Activity diagnosis.	Blinking (1-1-1): System startup. Blinking (1-5-1): Configuration reset to factory defaults. Blinking (steady): Device is seeking an IP address from a DHCP server.
Reserved	yellow	NA	NA

Table 5.4 ME LED Descriptions

LED	Color	Description
Link Status/Integrity	yellow	Network link is operational: On continuously indicates that an Ethernet connection is made or an access point is engaged.
Network Activity/Diagnostic	green	Network Activity: On when network traffic detected; off when no traffic detected. Diagnostic: Flashes three times in even duration during power up or reset, indicating successful startup.

- **Jumpers JP1, JP2, JP3:** These jumpers are used to set board options, e.g. the communications rate of the serial bus. Refer to the label on U2, the FPGA IC (see “SC-HCE-ME Serial/Ethernet Translation Assembly” on page 5-36), to determine the software version and thereby the jumper schedule to use.

Table 5.5 SC-HCE-ME Board Jumper Schedule for FPGA software V6.4.0 45BC0A

JP3	JP2	JP1	Result
Off	Off	Off	115.2 kHz baud rate (default setting)
Off	Off	On	460.8 kHz baud rate
Off	On	Off	230.4 kHz baud rate
Off	On	On	921.6 kHz baud rate
For board programming			
On	Off	Off	Board may be programmed
Off = No jumper in this position. On = Jumper in this position.			

Table 5.6 SC-HCE-ME Board Jumper Schedule for FPGA software V6.5.0 1DB38F

Jumper	Position	Description
JP1	Off	115.2 kHz baud rate (default setting)
	On	230.4 kHz baud rate
JP2	Off	Over clocking enabled (default setting)
	On	Over clocking disabled
JP3	Off	Self resetting of (Digi) data converter enabled (default setting)
	On	Self resetting of (Digi) data converter disabled
Off = No jumper in this position. On = Jumper in this position.		

Ribbon Cable Connection Point of connection for ribbon cable to serial driver assembly.

Status LEDs These LEDs are a quick way to check status:

- **FHCE OK:** Board fuse/power OK.
- **Bus Error:** If lighted, indicates a communication problem.

Fuse The FHCE OK LED indicates power presence “after” fuse. The fuse is 1/2A, 250V, AGC type.



Caution

Always power down the serial hall call driver and wait at least one minute before installing, replacing, disconnecting, or connecting an SC-HCME-EM or -ME serial to Ethernet board to avoid potential damage to the board PLD from a high voltage spike.

Trouble Indications

- Hall Call buttons do not work
 - Do building Hall Call buttons light when pressed?
 - Do building Hall Call buttons stay on until elevator arrives?
- Elevator reported to be in “Wild Operation” (stopping at every floor)
 - Does the iBox LCD display indicate Emergency Dispatch?
- LEDs not lighted on the base board of the serial/Ethernet assembly.
- EM: Serial Port and Reserved LEDs lighted solidly. Network Link Status and Diagnostics OFF.
- ME: Both Network Link and Network Activity LEDs OFF.
- Hall Call LEDs or lamps flashing or not operating normally.

Quick Check

- During power up:
 - Two red SC-HCE board LEDs (FHCE and Bus Error) should remain on for 30-40 seconds after the Hall Call Driver is powered-up.
 - After solid-on, LEDs will cycle through a period of start up activity then indicate normal operation as described below.
- Normal operation indication:
 - Network Link Status LED on solidly (EM top left, green; ME left, yellow).
 - Network/Serial Port Activity LED flashes once every five seconds (EM top right, green; ME right, green) when communicating with iCue.
 - Network/Serial Port Activity LED should flash once when a Hall Call button is pressed.
 - FHCE (red) LED on SC-HCE board solidly on.
 - Bus Error (red) LED on SC-HCE board off.
- Auto Reset
 - With no jumper across JP3 on the SC-HCE board, the assembly PLD will initiate a reset every 60 seconds if it does not see communication from iCue.
 - Check that the iCue software is running properly on the PC. If not, restart iCue by clicking the Windows Start button and selecting Start/Programs/Startup/iCue.
 - Recheck.

General Check

1. Check all power and data cable connections.
 - Port status LED on System hub should light when the Ethernet cable is plugged in between the hub and the serial/Ethernet board.
 - Ribbon cable seated properly on the hall call driver and the serial/Ethernet board.
 - Use a voltmeter to measure between each of the three DC voltages (3.3V, 5V, 9V) on the serial/Ethernet (SC-HCE) board to ground. Voltages should read the provided level, +/- 10%.
2. Check the SC-HCE board to see that there are no jumpers across JP1, JP2, or JP3.



iView Check Use the iView System I/O Configuration screen, Bus tab to see if trouble is indicated and to check that hall calls are addressed as specified in your job prints.

1. Launch iView and connect to the group.
2. Open the System I/O Configuration screen and select the Bus tab.
3. Verify the state of the indicator LEDs and that the addresses are as defined in the group job prints (inputs as expected per serial address and Labels mapped to correct floor).

System
Bus

Inventory / Test response

Select bus 1

Node address	Input inventory	Output inventory	Input / Output	Association	Test results
010					
011					
012					
013					
014					
015					
016					
017					
018					
019					
020					
021					
022					
023					

Input inventory
Output inventory
Input test
Output test

Bus status

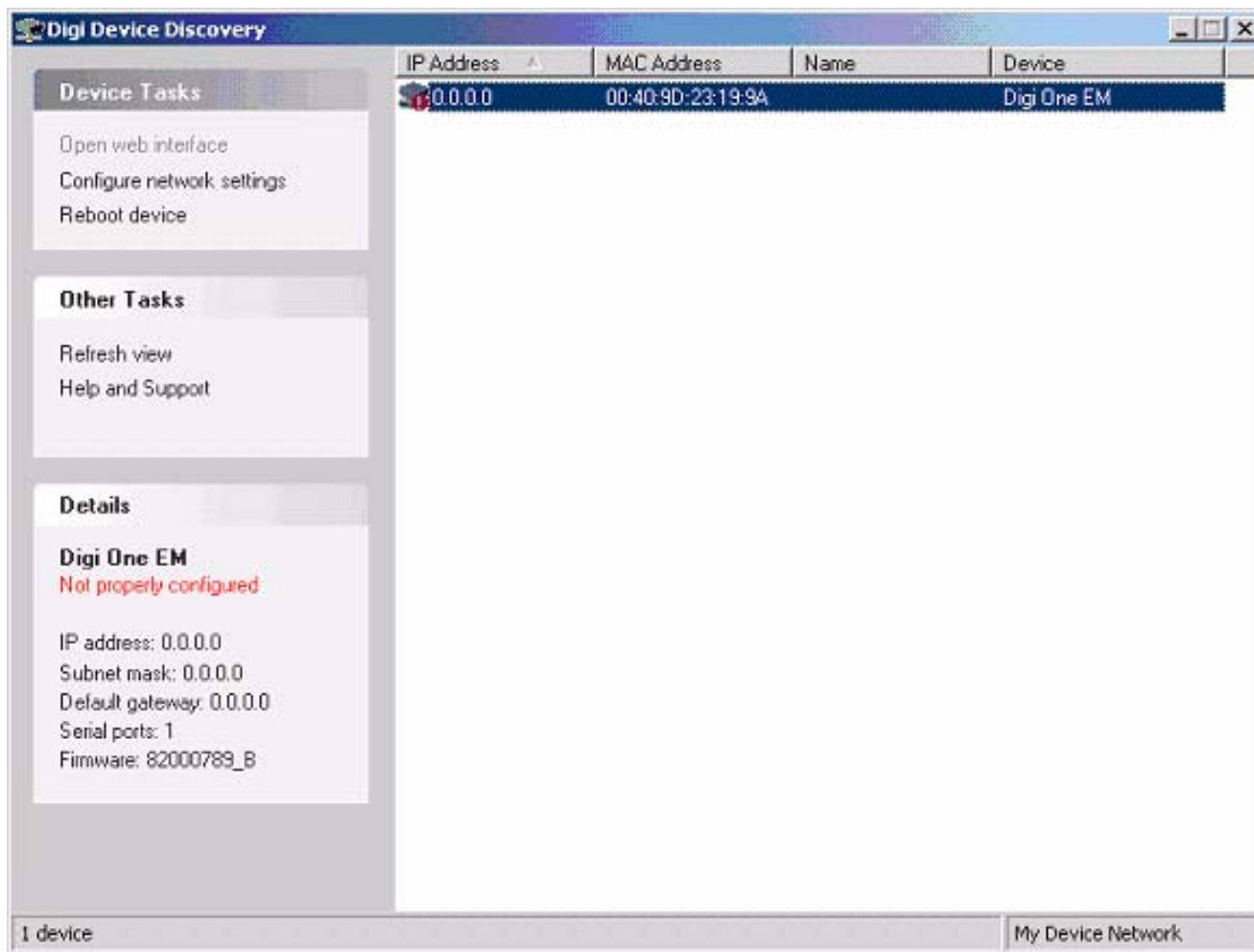
	Bus 1	Bus 2	Bus 3	Bus 4
Connected	●	●	●	●
Bus voltage	●	●	●	●
Driver VDC	●	●	●	●
Node control	●	●	●	●
Bus enabled	●	●	●	●
High current	●	●	●	●

Wrapback option

- Bus 1
- Bus 2
- Bus 3
- Bus 4

TCP Address Check The Digi Device Discovery utility may be used to check and, if necessary, reset the TCP/IP address of the serial/Ethernet assembly (SC-HCE-EM or ME). This utility is available from MCE.

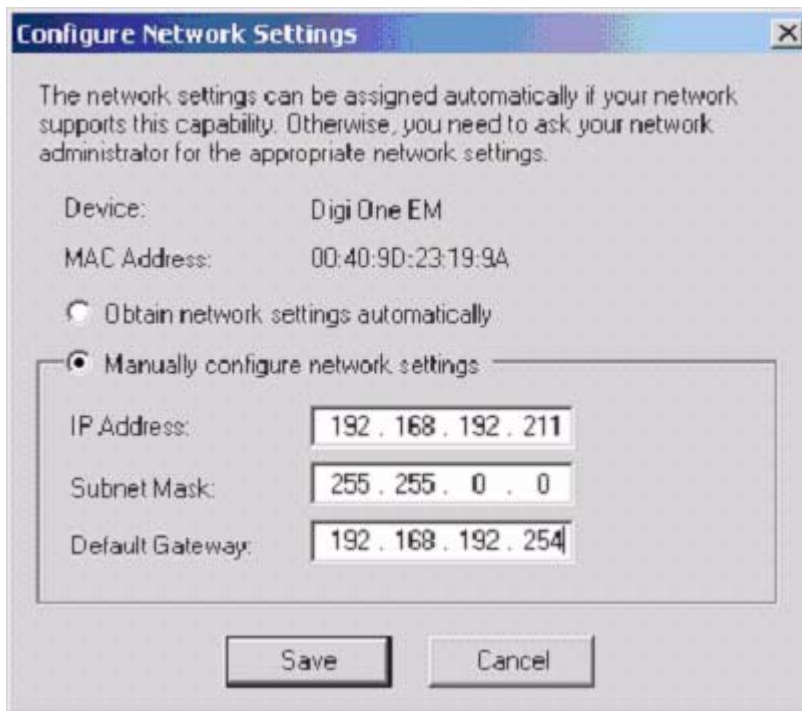
1. Start the Digi Device Discovery utility. The utility will launch, and check the System network for any connected SC-HCE-EM or -ME.



5

2. Select the device. Click on Configure Network Settings.

3. In the Configure Network Settings dialog that appears, select Manually configure network settings.

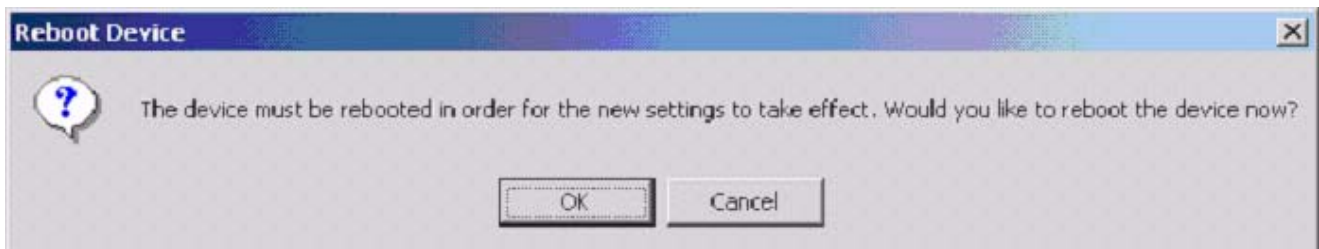


4. Check the drawing package for the dispatcher or the Ethernet Address examples drawing in the manual. [Please refer to “Example of Ethernet Addresses and Connection” on page 5-16.](#)
5. If the IP address of the device is incorrect, set it appropriately.

Note

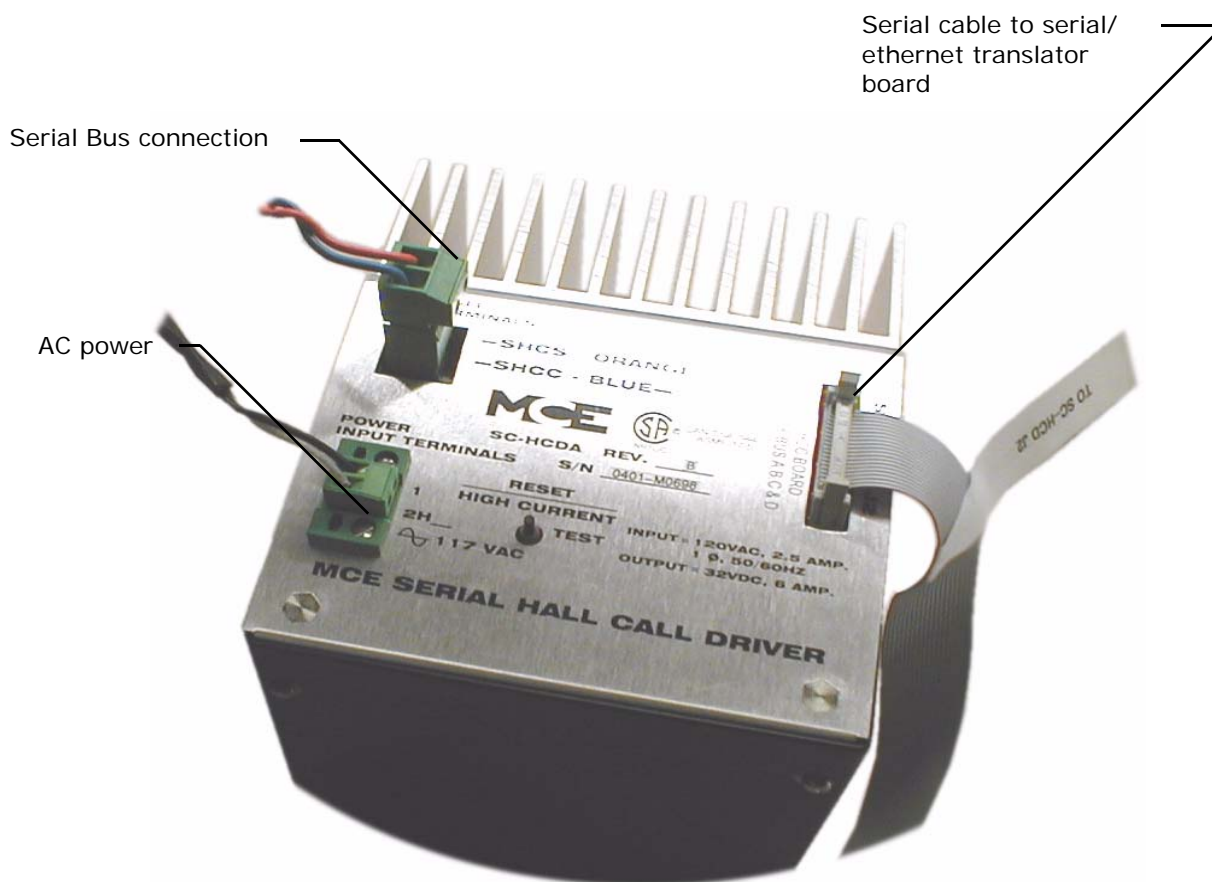
When entering the IP address, do not enter leading zeros. For example, in the address 192.168.192.056, 056 is entered as 56, with no leading zero.

6. Click Save. A Reboot Device dialog will appear:



7. Wait for ten to fifteen seconds (until the Diagnostic LED on the serial/Ethernet assembly blinks for eight to ten seconds and then goes off), then click OK.
8. Restart the iCue PC.

Hall Call Driver



Quick Test You can do a basic functionality test on the hall call driver.

With power applied:

1. Verify 120VAC power to the driver.
2. Unplug the Serial Bus connection (orange/blue wires).
3. Use a voltmeter to check the voltage between SHCS and SHCC. You should see approximately 30V, + or - 10%. (This voltage will only be present if the SC-HCE-ME or EM is working properly as verified in preceding troubleshooting steps.)

If this voltage is present, the driver is probably operating properly.

Driver Voltages Test The hall call driver can be more thoroughly tested if necessary. The test is relatively simple on iCentral units shipped after July, 2005 because a female, “test” connector has been installed in the middle of the ribbon cable connecting the driver to the SC-HCE (Digi board) assembly. Earlier units do not have the test connector.



Note: Digi-board connector ground pins are 2,3,4,6,9,11,12,13,14,15, and 17.

1. Cut three pieces of 22 AWG solid wire 2” in length. Strip ½” insulation off each end. These will be used as “jumpers” and test probes during the test.
2. At the SC-HCE board end, disconnect the ribbon cable connected to the hall call driver. Note the test connector in the middle of the cable. Its pinout is as shown.



Alternatively, if the cable does not have a test connector, insert a 20 conductor ribbon cable, with a female connector at each end, into the SCHCD J2 socket.

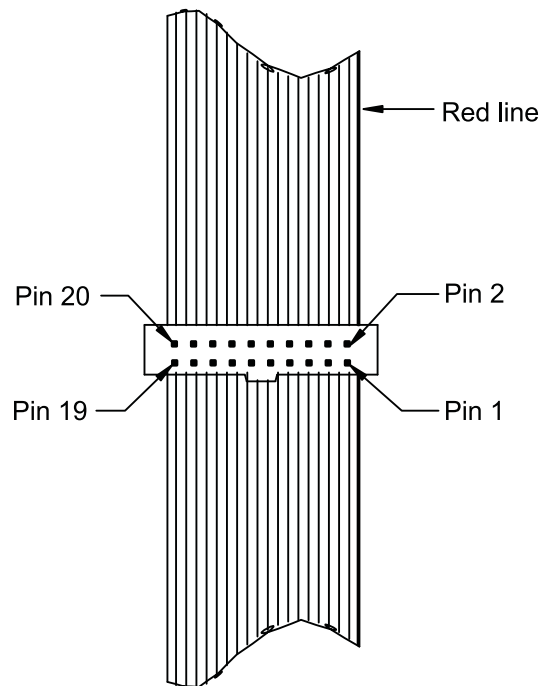
3. Remove orange and blue bus wires from the hall call driver bus terminal connector.
4. Connect 120 VAC power to Serial Hall Call Driver power input terminals.
5. Insert the negative DC voltmeter lead to the Hall Call Bus SHCC Terminal connector.

• Driver DC power supply test

1. Insert a wire test probe into pin 19. Connect the positive voltmeter lead.
2. You should see 42-volts (+/- 10%). Remove the wire probe.

• Digi-board DC power supply test

1. Connect the positive voltmeter probe/lead to pin 8.
2. You should see 10-volts (+/- 10%).



- Node Response test
 1. Insert a probe wire into pin 20, connect the positive voltmeter lead.
 2. You should see 5-volts, +/- 10%. Leave the probe wire in place.
 3. Bend the wire/jumper and short pin 20 to pin 17.
 4. Insert a probe at pin 5 and connect the positive voltmeter lead.
 5. You should see something under 1-volt.
 6. Leave the pin 20 to pin 17 jumper in place and the positive voltmeter lead connected to pin 5.
 7. Use a second jumper to short pin 10 to pin 12.
 8. You should see something over 20 volts.
 9. Leave the pin 20 to pin 17 jumper in place. Remove the lead from pin 5.
 - Driver output voltage test
 1. Place the positive DC voltmeter lead on the Hall Call Bus SHCS Terminal.
 2. You should see something over 35-volts.
 3. Insert a probe wire at pin 16 and connect the positive voltmeter lead
 4. You should see something over 25-volts.
 5. Leave the pin 20 to pin 17 jumper in place. Remove the lead from pin 16.
 - Node control flag test
 1. Insert a probe wire at pin 18 and connect the positive voltmeter lead.
 2. Bend the wire probe and temporarily short pin 18 to pin 17 or pin 15.
 3. Watch the voltmeter as you unplug the wire from pin 17 (or 15), it should read less than 1-volt when the short is released.
 - Node control flag test preferred alternate method
 1. Install a ¼ Watt 10K Ohm (brown, black, red) resistor between pin 15 and pin 18 and connect voltmeter to pin 18.
 2. Release pin 20 from the ground (pin 17). The voltmeter should read something over 20-volts.
- If the preferred alternate method is used you will see a short positive pulse on your voltmeter.**
1. Place the positive DC voltmeter lead on the Hall Call Bus SHCS Terminal. The voltmeter should indicate less than 1-volt.
 2. Remove all test connections. If the driver passed all of the above tests it will likely operate OK.

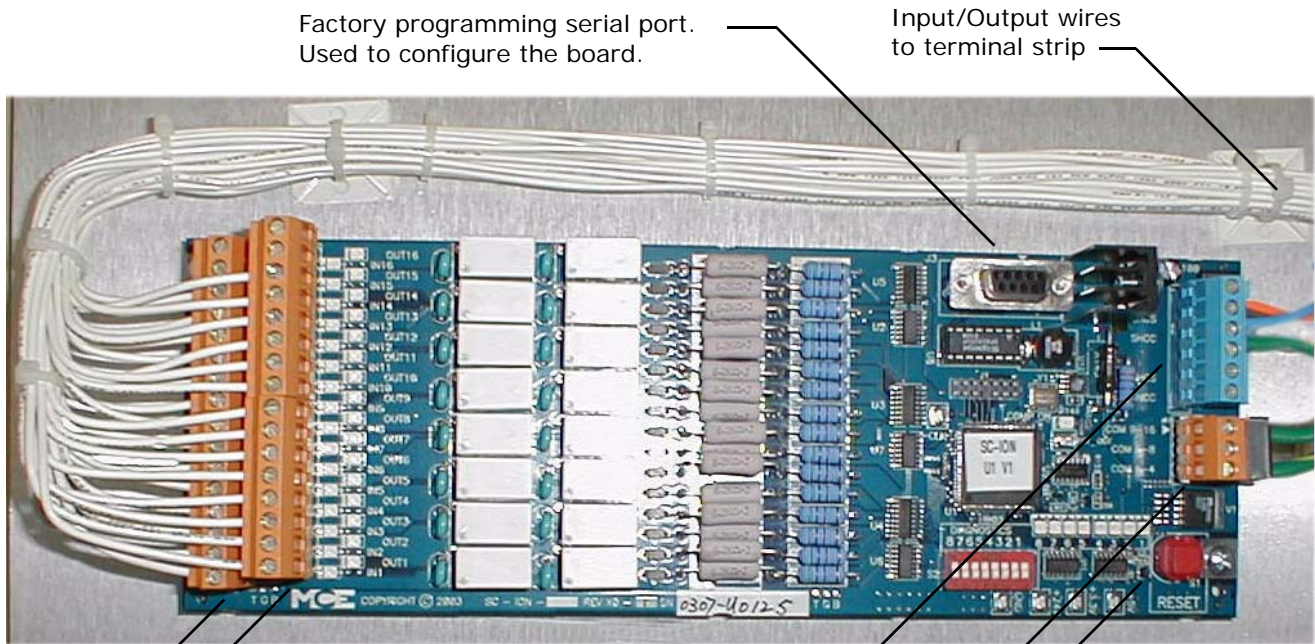
Flexible I/O

iCue makes extensive use of a serial bus to handle a range of communication and control needs. The serial bus is used to service the MCE Serial Hall Call System and to control I/O through one or more SC-ION boards (input/output expansion boards). Each SC-ION board provides 16 user-configurable inputs and 16 user-configurable outputs. Input and output configuration, using the MCE iView graphical user interface, is described in Section 6 of this guide. This section describes physical I/O connections.

SC-ION Boards

The number of SC-ION boards in an iCue system will vary depending upon system configuration and the number of additional inputs and outputs required for the job. A typical job might have one SC-ION board, providing 16 additional inputs and 16 additional outputs.

Figure 5.20 SC-ION Board in iCue Cabinet



Inputs
Outputs

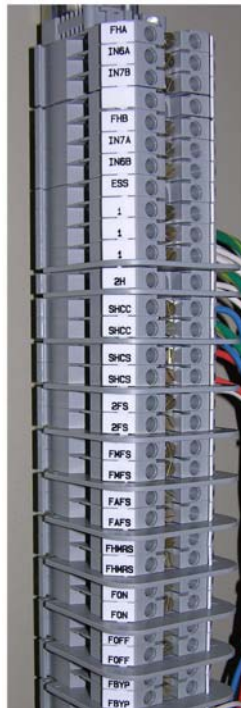
Factory programming serial port.
Used to configure the board.

Input/Output wires
to terminal strip

MCE Serial Bus Connection

Board Reset

High/Low (Current
Source/Current Sink)
Output Selection (J4)



In this configuration, inputs and outputs have been routed to clearly labeled terminal strips for easy user identification and connection.

Terminal strips are located behind the hinged panel inside the iCentral cabinet, mounted for convenient user access.

I/O Connections

Connect inputs and outputs as shown in your job prints. SC-ION board inputs are always 117VAC. Outputs may be configured (in specific groups) to provide either a path to ground or current to drive indicator lamps/LEDs.

Output State Selection The outputs are divided into three groups. Each group shares a common. The common may be wired to provide a current source or a path to ground. The groups are:

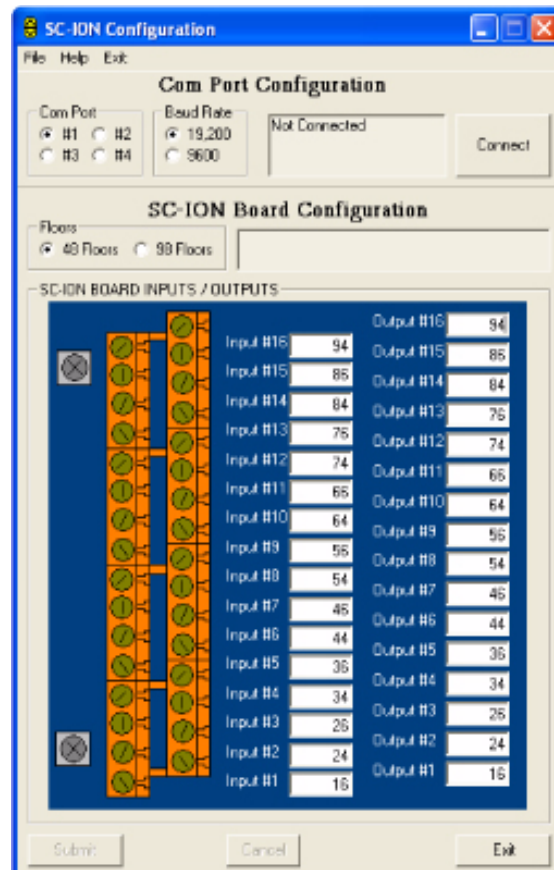
- Relays 1 – 4
- Relays 5 – 8
- Relays 9 – 16

The commons for the groups are determined by the connections made to board connector J4. The appropriate connections are determined during the job survey. Each system is configured before shipment. You need only connect the inputs and outputs as shown on the job prints.

Board Addresses Each of the 16 inputs and 16 outputs on the board has an address on the system bus. The addresses are assigned as indicated by the job survey before the system is shipped. A software tool, running on a Windows platform, is used to set individual addresses and also to set the address range (10-488 or 10-988) used for the job. To configure the board, a Windows PC running the software tool must be connected to the board serial port.

Board Programming

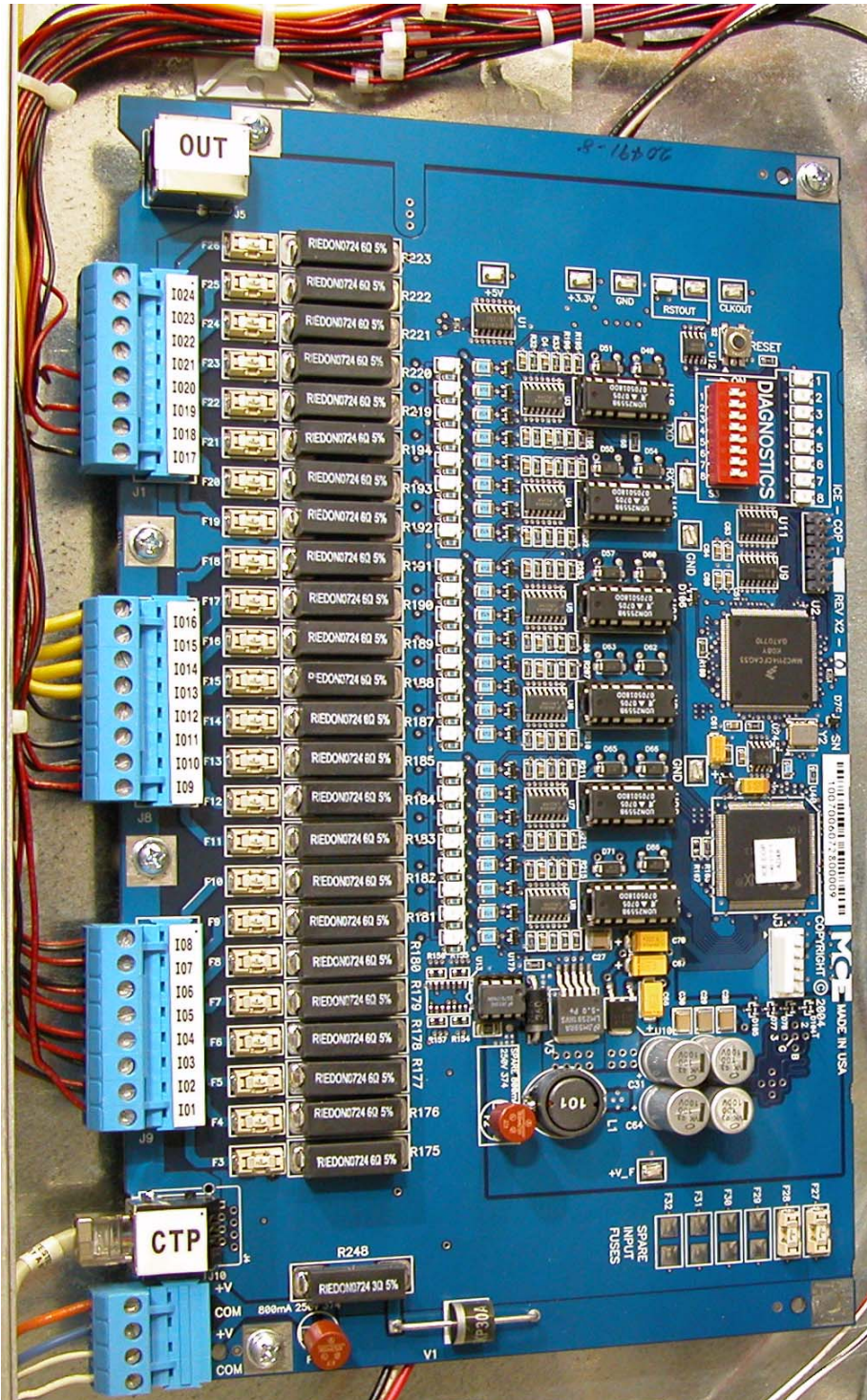
Addresses are programmed for each SC-ION board input and output at the factory using a tool called SCION Configuration.exe. You should never have to use this tool without factory technical support. A typical programming screen from SCION Configuration is shown for informational purposes:



Serial COP

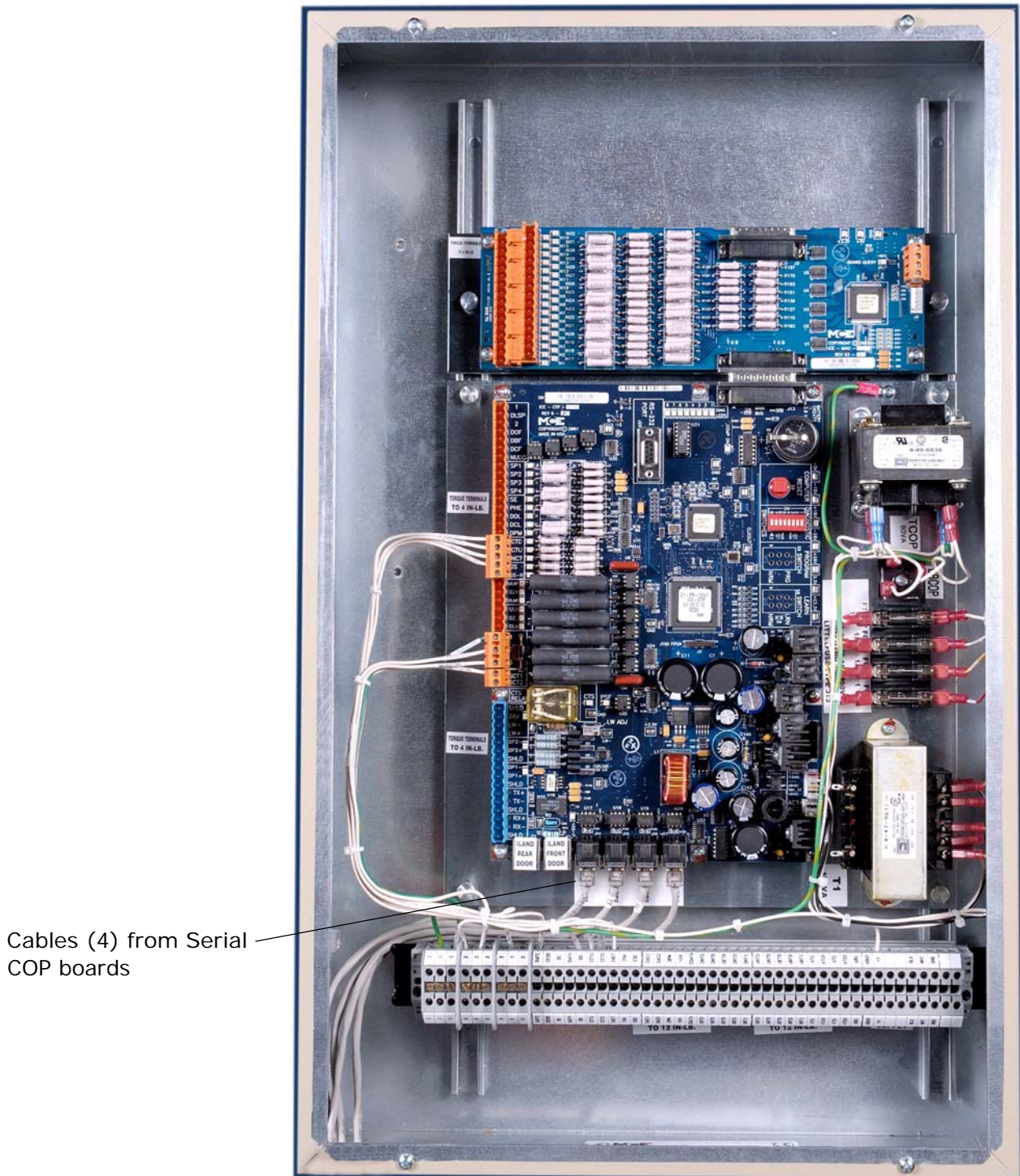
With the Serial Car Operating Panel system, car call buttons connect directly to a serializing board located in the car station enclosure. Multiple Serial COP boards daisy-chain together to accommodate high-rise installations with a lot of call buttons.

Figure 5.21 Serial COP board - typical installation



Wiring from the Serial COP board(s) to the iLink cartop box is a short length of shielded cable with a telephone-style RJ-11 connector at each end. The iLink cartop box supports up to four serial control panel connections. Communication between iLink and the controller is also serial, thereby reducing the traveler and hoistway cabling.

Figure 5.22 iLink Cartop Box



Cables (4) from Serial COP boards

Serial COP Board Specifications

Each Serial COP board handles up to 24 call buttons or switches. If more inputs are required, Serial COP boards are daisy-chained together.

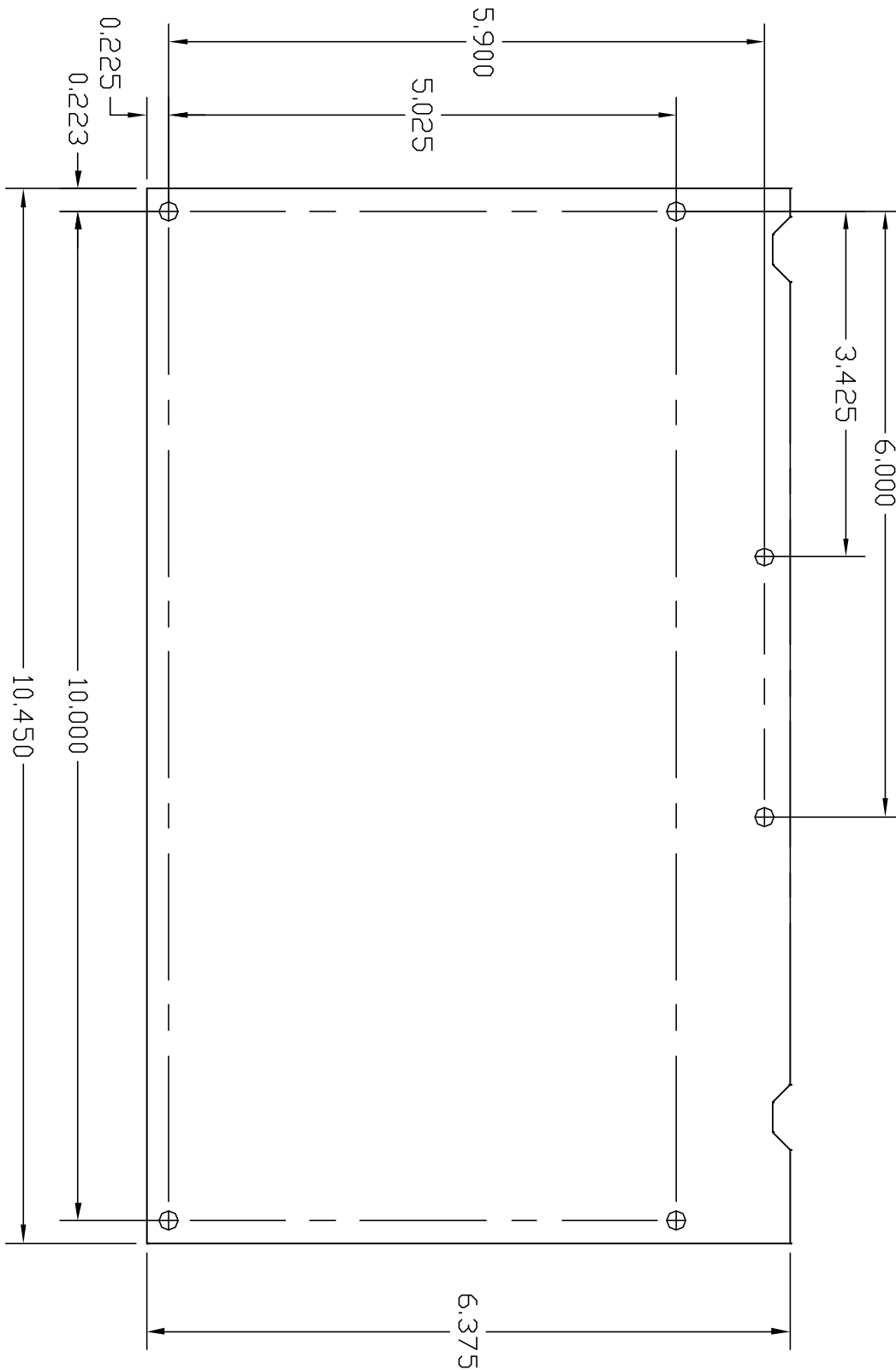
- Each of the Serial COP board's 24 I/O connections can be used as an input, an output or a combined call input and output.
- Pluggable connections are provided for COP buttons and switches.
- Inputs can be 12 - 24 VDC (24V preferred).
- Outputs: 24V, 6W (maximum) lamps or 250mA LEDs recommended.
- Socketed, easily replaceable drivers protect the board from damage due to out-of-range inputs.
- The initial Serial COP board (ICE-COP) communicates with the iLink ICE-CTP board using an RJ-11 cable.
- Additional Serial COP boards (ICE-COP-X) are daisy-chained using RJ-11/RJ-45 cables.
- All Serial COP board I/O assignments are field configurable using the iView Configuration > I/O Boards > Configuration tab. [Please refer to "Configuration - I/O Boards" on page 9-100.](#) The signal types include:
 - Car calls
 - Car call enables (security)
 - Enable overrides (security)
 - Door controls
 - Car status
 - Position indicators
 - Alarm I/O
 - Load indicators
 - Operating mode I/O including: Fire service, Attendant service, Independent service, Flood operation, Inspection operation, Swing operation, Earthquake operation, Sabbath operation, Recall operation and CFSS (Commander for Special Service) operation.

Serial COP Installation

1. Mount the Serial COP boards in the car operating panel (recommended orientation: [see “Serial COP board - typical installation” on page 5-48](#). Drilling dimensions are provided. Please refer to [“ICE-COP Board Mounting Dimensions \(not to scale\)” on page 5-52](#).
2. Connect the COP switches and lamps to the Serial COP board(s) using the plugable connectors. Refer to job print drawings - Cartop Details (-CTx).
3. Verify the COP board I/O assignments using the iView Configuration > I/O Boards > Configuration tab.

ICE-COP Board Diagnostics The DIP switches and LEDs in the upper right corner of the ICE-COP board provide diagnostic information. [Please refer to “ICE-COP Serial Car Operating Panel Board QR” on page 6-83](#).

Figure 5.23 ICE-COP Board Mounting Dimensions (not to scale)

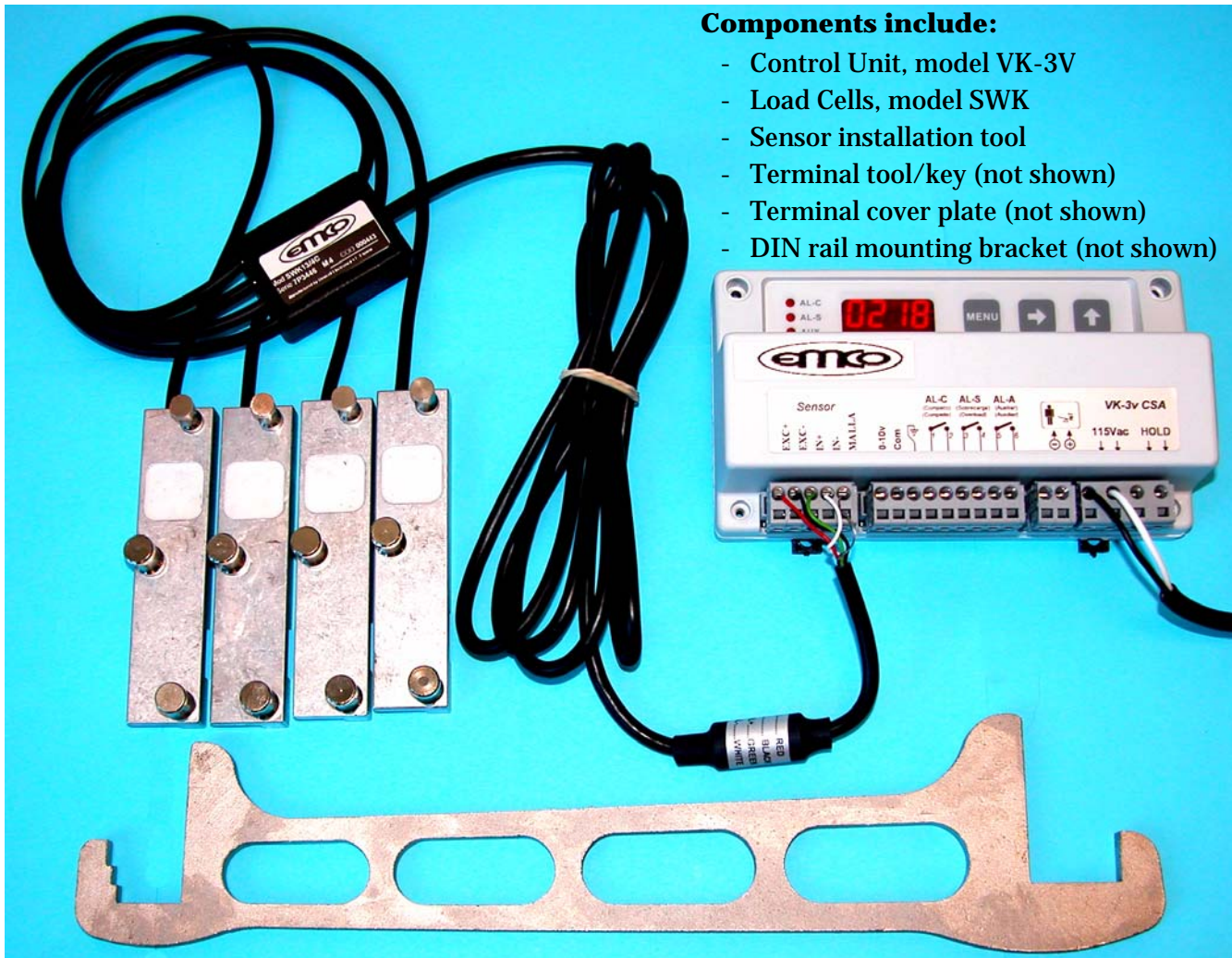


EMCO Load Weigher Installation and Calibration

This instruction pertains to the installation and calibration of the Elevator Motors Corporation, EMCO, Load Weigher. The following topics are covered.

- Installing the EMCO Load Cells (Sensors) (see [page 5-54](#))
- Installing the EMCO Control Unit and connecting the wires (see [page 5-55](#))
- Control Unit description of operation (see [page 5-56](#))
- Load Weigher calibration procedure ([page 5-57](#))
- Final calibration with iControl (see [page 5-59](#))
- Installation with 2 to 1 roping (see [page 5-61](#))
- Verifying the zero calibration (empty car weight) (see [page 5-62](#))
- Troubleshooting (see [page 5-62](#))

EMCO Load Weigher



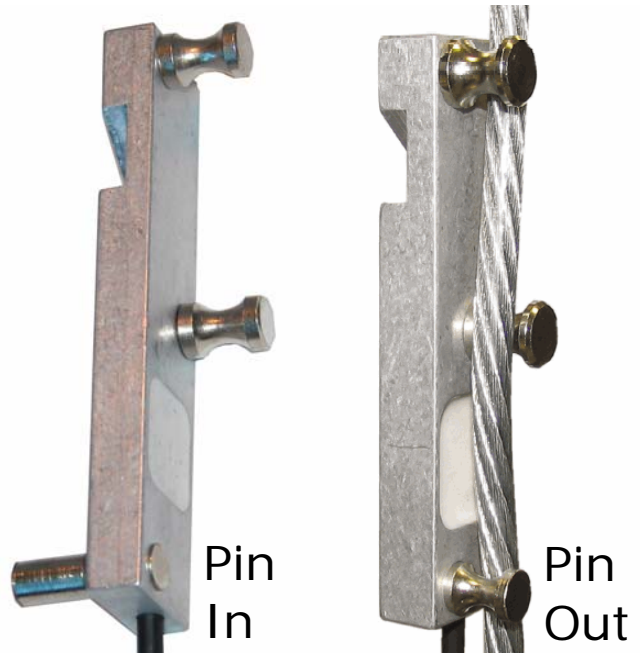
Components include:

- Control Unit, model VK-3V
- Load Cells, model SWK
- Sensor installation tool
- Terminal tool/key (not shown)
- Terminal cover plate (not shown)
- DIN rail mounting bracket (not shown)

Installing the Sensors

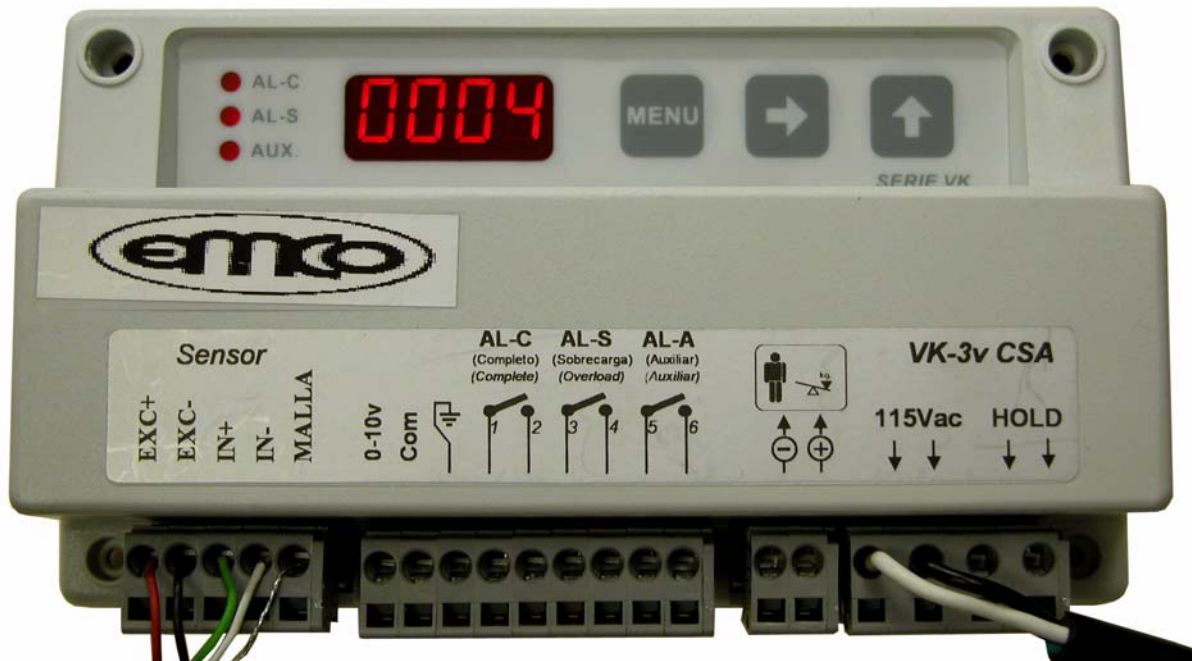
The model SWK sensors are installed using the tool supplied. In some instances it may be necessary to extend the length of the handle to gain more leverage.

1. Typically the sensors are mounted on the wire ropes directly above the cartop hitch. However, with 2 to 1 roping the sensors must be mounted below the dead-end hitch beneath the overhead. [Please refer to "Installation with 2 to 1 Roping" on page 5-61.](#)
2. Notice that one of the sensor's pins moves in and out. Move the pin to the in position as shown.
3. Place the sensor on the wire rope and using the installation tool, apply leverage to rotate the sensor until the pin can be moved to the out position as shown.



Installing the Control Unit and Connecting the Wires

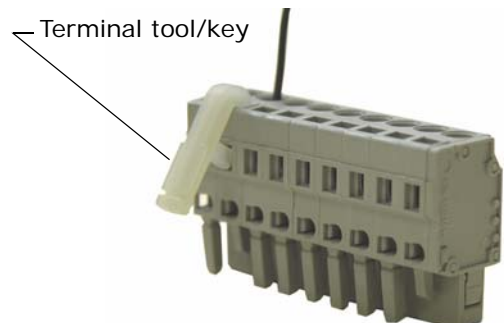
The control unit may be mounted using the DIN mounting bracket supplied or using the holes in the sensor itself. Choose a convenient location on the cartop. (For iControl, if there is space, the control unit could be mounted inside the iLink enclosure.)



Three sets of wires must be connected to the EMCO VK-3v control unit:

1. a. For iControl, EMCO control unit output to ICE-CTP board in the iLink Cartop box:
 - connect CTP board terminal LW- to EMCO control terminal Com.
 - connect CTP board terminal LW+ to EMCO control terminal 0-10v.
 - connect CTP board terminal SHLD to the cable shield (do not connect the shield to the EMCO control unit).
1. b. For IMC or Performa, EMCO control unit output, through the traveler, to the controller.
 - connect SCR-RI (or SCR-RIX) board terminal LW- to EMCO control terminal Com.
 - connect SCR-RI (or SCR-RIX) board terminal LW+ to EMCO control terminal 0-10v.
2. 115Vac power, connected to the terminals labeled 115Vac.
3. Sensor wires, connect the control unit as indicated on the sensor wire:
 - red wired to terminal EXC+
 - black wire to terminal EXC-
 - green wire to terminal IN+
 - white wire to terminal IN-
 - shield wire to terminal MALLA

Use the Terminal tool/key (wire insertion tool), or a narrow flat blade screwdriver to open the detent in the terminal connector to allow insertion of the tinned wires.








PROGRAMMING the EMCO VK-3v Control Unit

Description of Operation

The purpose of the EMCO Load Weigher system is to measure the load in the elevator and provide usable information about the load to the elevator controller. This information is used for pre-torquing and for dispatching decisions, e.g. light load anti nuisance, heavy load and overload.


The system usually consists of a sensor or group of sensors mounted on the elevator's wire ropes and a control unit. The sensor(s) provide a signal to the control directly related to the amount of load in the cab. The load weigher control accepts this signal and provides usable data to the elevator controller in the form of an analog signal.










How to Program the EMCO Load Weigher Control Unit

- Press the  menu button until the display shows the desired parameter to be changed.
- Press the  button to select the digit to be modified (digit blinks when selected).
- Press the  button to change the digit.
- Press the  menu button twice to save the new value. Once a value is saved the control will display the next parameter.
- If you do not press the  menu button twice the changes will not be stored and the control display will continue to show the parameter you were modifying.

Menu/Programming Order

Installation Menu

Pressing the  menu button will scroll through the Installation Menu in the following order:

-  - Measured weight in car (value displayed varies with load in car)
-  - Overload weight
-  - (not used)
-  - (not used)
-  - Learn empty car weight (Zero weight)
-  - Learn full load weight (Calibrate with Weights)
-  - (not used)
-  - Auto-zero calibration (used as required)
-  - (not used)







Calibration









Manual Calibration with Weights

The Calibration with Weights procedure is the most accurate and recommended method of calibrating the EMCO Load Weigher. This procedure allows the EMCO control unit to do the following:

- Learn the empty weight of the car and set this weight as the zero reference (the analog voltage output from the control unit will be about zero volts at this weight).
- Learn a known weight. You place a known weight in the car and enter the actual value of the weight, in kilograms, into the control unit. The load weigher will then learn this weight
- You will also enter the value of the car's overload weight into the control unit.
- The EMCO control unit will use this information to scale the analog output so that when the sensors detect the overload weight, the output voltage is about 10 volts. The analog output for the weights between empty car weight and overload weight will then be linear from about 0.0 volts to 10 volts.

Calibration procedure:

1. Before programming or calibrating the sensors and control unit:
 - Bring car to the lowest floor of its total travel.
 - Bounce in car to verify that it is free on guide rails.
2. Verify that the sensors are properly connected to the control unit.
3. Power up the control unit and verify that the input voltage is within the voltage range of the control unit.
4. Verify that the sensors are installed on the wire ropes per the previous instructions.
5. **Learn the empty car weight** (Zero the control unit):
 - Press the  menu button until C E r 0 is displayed.
 - Press the  button once. The display will flash.
 - While the display is flashing, press the  menu button once. If the display stops flashing before you press the menu button, you must start over.
 - The control unit's display begins to count down. Exit the cartop before the countdown finishes.
 - When the zero calibration is complete, P E S 0 will be displayed. If P E S 0 is not shown, the value has not been saved and this step must be repeated.
6. **Learn the full load weight:**
 - Press the  menu button until P E S 0 is displayed, if it is not shown already.
 - Add the full load weight to the car.
 - Enter the value of the full load weight, in kilograms (1lb = .45359Kg). For example, if the full load weight is 2000lb, enter 0907 (2000 x .45359 = 907.18). Press the  button to select a digit (blinks when selected) and press the  button to set the value.

- Press the  menu button twice. The control unit's display begins to count down. Exit the cartop before the countdown finishes. When the full load weight has been learned,  will be displayed. You can press the  menu button until the weight is shown on control unit display. The weight displayed should be the value of the weights in the car, in kilograms.
7. **Enter the overload weight** into the control unit:
 - Press the  menu button until  is displayed.
 - Enter the value of the overload weight, in kilograms (1lb = .45359Kg). Press the  button to select a digit (blinks when selected) and press the  button to set the value.
 - Press the  menu button three times. (Note that when the menu button is pressed once, it displays "On" to allow you to set the AL C relay to normally open or normally closed. MCE does not use this relay, so just continue pressing the menu button two more times to save the value).
 8. With the full load of weights in the car, using a digital multi meter, measure the voltage at terminals **0-10v** and **Com** on the control unit. It should be approximately 8 volts. Note the exact value.
 9. Proceed to *Final Calibration with iControl* on [page 5-59](#) and *Additional iControl Settings and Procedures* on [page 5-60](#).






Auto-zero Calibration

The EMCO load weigher has an auto-zero calibration option which can be used if needed. Typically this option is recommended for 2 to 1 roping or where guide shoes, rather than guide rollers, are used.

How auto-zero calibration works:

- The control unit must see no power on the Hold terminals. Some installations use these terminals to indicate when the doors are closed, but with MCE controllers these terminals are not used.
- The CAde parameter must be set to 50.
- When the control unit senses no change in weight for two minutes, it automatically performs the CEro zero load calibration (learns the empty car weight).

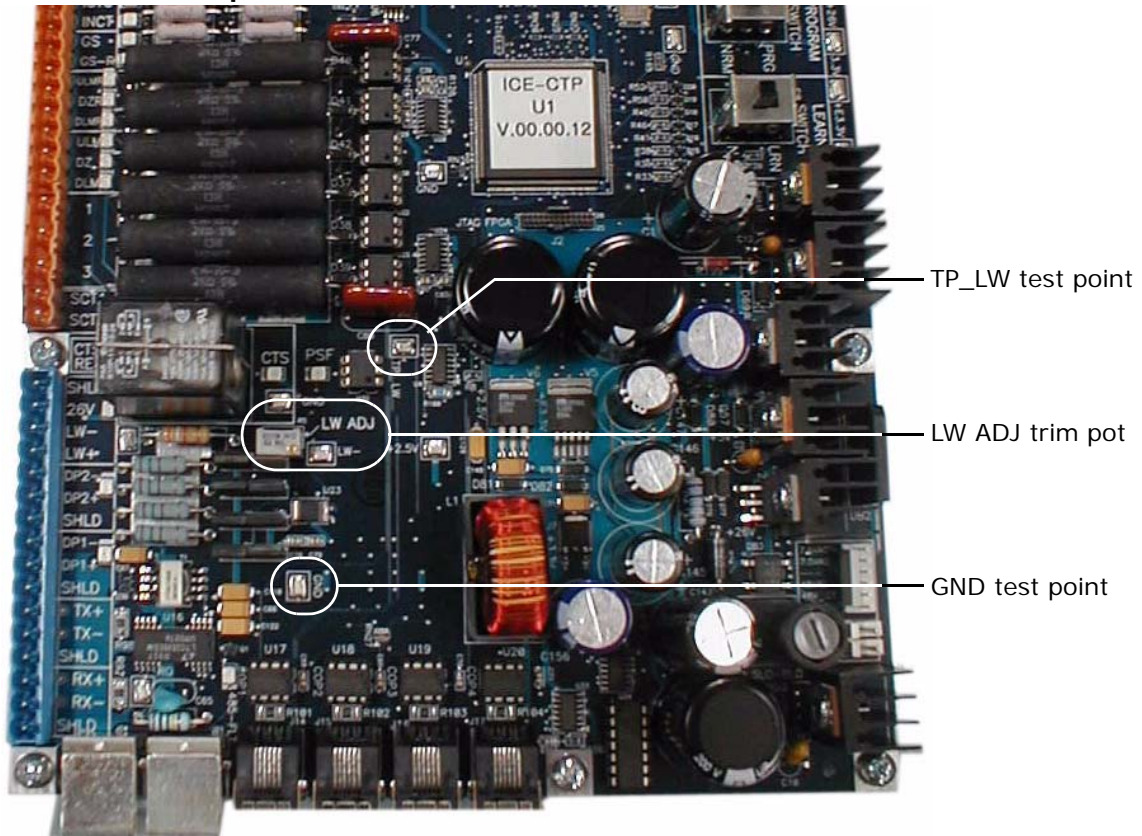
To enable auto-zero calibration:

1. Press the  menu button until  is displayed.
2. Enter the value 50. Press the  button to select a digit (blinks when selected) and press the  button to set the value.
3. Press the  menu button twice to save the value.

Final Calibration with iControl

1. Connect the multi meter to test points **TP_LW** and **GND** on the ICE-CTP board inside the iLink Cartop Box. Adjust trimpot **LW ADJ** until the multi meter reads the same as the value noted in step 8.

Figure 6. ICE-CTP Cartop Processor Board



2. To view the voltage values from the load weigher using the iView Virtual Oscilloscope:
 - Using iView, connect to the controller
 - Display the Virtual Oscilloscope (View > Virtual Oscilloscope)
 - Select Load Weigher (Raw) for Test point 1
 - Observe the Load Weigher voltage values on the digital display.
3. To verify the linearity of the load weigher, place weights in the car that represent the following and observe the voltage values:
 - Empty car - about 0.0 volts
 - 25% of overload weight - about 2.5 volts
 - 50% of overload weight - about 5.0 volts
 - 75% of overload - about 7.5 volts
 - Full load weight - about 8 volts
 - Overload weight - about 10 volts

Additional iControl Settings and Procedures

Verify the following iControl settings and procedures:

1. On the iView Controller > Configuration > Load Weigher tab:
 - Set *Load weighing device type* to *Analog signal*.
 - Set *Sensing type* to *Cross head deflection or rope tension sensing*.
2. If the load weigher will be used to implement dispatching options, the parameters associated with these options must be set (see *Load Weigher Adjustment for Dispatching* in Section 4 of the iControl User Guide).
3. iControl needs to learn the empty and full load weights at every landing available to this car. This is a semi-automated process (see *Learning Load Values* in Section 4 of the iControl User Guide).

Installation with 2 to 1 Roping

When the EMCO load weigher is used with 2 to 1 roping, the components must be installed in locations that are different from a 1 to 1 roping application.

The load cells (sensors) must be installed just below the dead-end hitch, as shown.

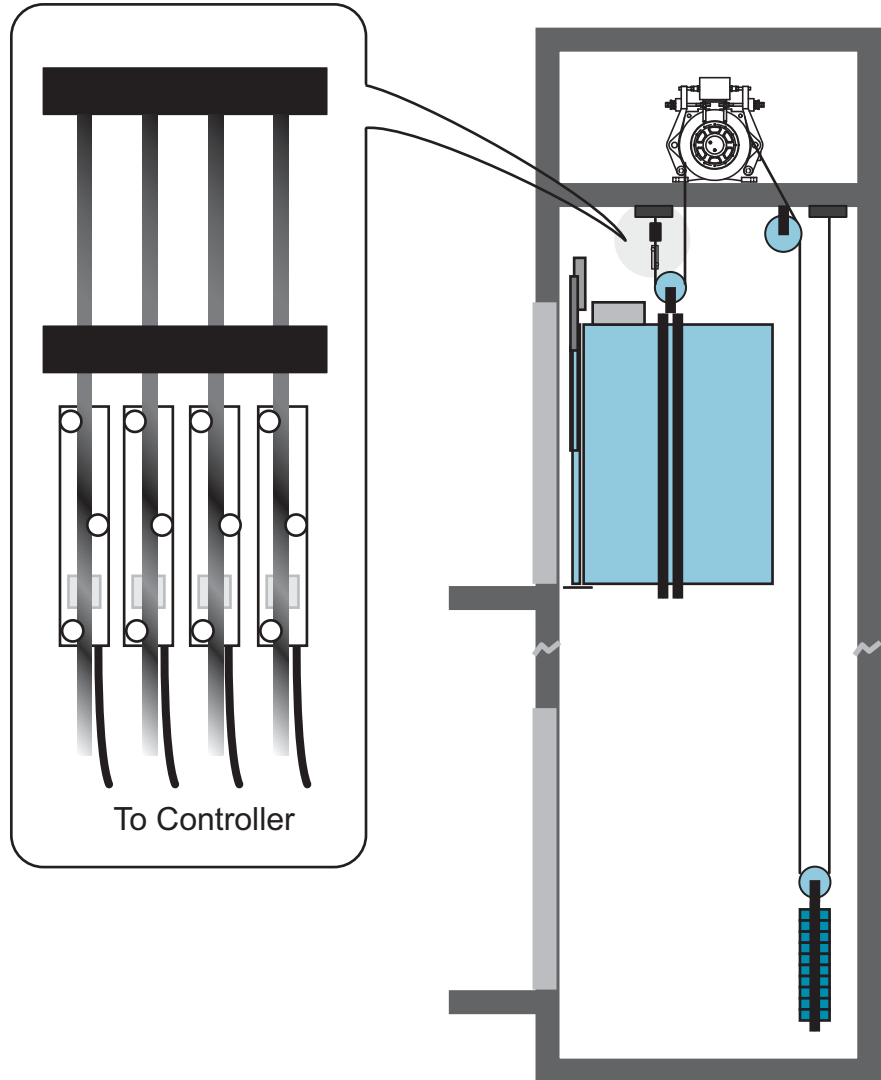
It is recommended that the EMCO control unit be mounted in the controller cabinet.

The signal wires from the load cells must be routed through the overhead to the machine room. The sensor wires, which are only 6 feet in length, must be extended. It is recommended to use a terminal block to join the wires and to route the extended wires through a flexible or rigid conduit.

For an IMC or Performa installation, the output from the EMCO control unit can be connected directly the LW+ and LW- terminals on the SCR-RI (or SCR-RIX) board inside the controller cabinet.

For an iControl installation, the output signal from the EMCO control unit must be routed through the traveler to the LW+, LW- and SHLD terminals on the ICE-CTP board located inside the iLink Cartop box.

It is recommended to enable the Auto-zero Calibration option for a 2 to 1 roping installation. [Please refer to “Auto-zero Calibration” on page 5-58.](#)



Verifying the zero calibration (empty car weight)

It is recommended to verify the zero calibration if:

1. When working with new ropes, the calibration may change slightly as the ropes settle. After the first 30 days of operation it is recommended to check the empty car weight, with the car in the middle of the hoistway, using the display on the EMCO Load Weigher. If the empty car weight has changed (no longer zero), at a minimum the empty car weight should be re-learned (steps 1 through 5 of the calibration procedure).
2. If the car experiences violent motion, e.g. emergency stop or car / counterweight contacts the buffers, it is recommended to check the empty car weight, with the car in the middle of the hoistway, using the display on the EMCO Load Weigher. If the empty car weight has changed (no longer zero), at a minimum the empty car weight should be re-learned (steps 1 through 5 of the calibration procedure).

Troubleshooting

1. Check for Err codes on the display.

Err1 = Bad load cell connection or damaged load cell. Verify that the load cells are connected to the control unit per the wiring diagram. Inspect the cables for cuts or broken wires.

Err2 = Negative load cell flow. Verify that the load cell connections to the control unit are per the wiring diagram.

Err3 = Positive load cell flow. Load cells are too small for the application and must be replaced with proper units.

Err4 = Polarity error. Verify that the load cell connections to the control unit are per the wiring diagram. Reprogram the control.

Err5 = MB-D display short. Locate the short. Disconnect MB-D display, turn off the control and reconnect the MB-D display.

Err6 = Loss of data in memory. Reprogram the control.

2. Verify that proper voltage is being supplied to the control unit.
3. Check all of the connections to the control unit.
4. Check the fuse. To check fuse: Disconnect power to the control unit. Open the control unit by removing the five (5) screws that hold the cover. Remove fuse from vertical free mounting (black) fuse holder next to controller transformer and replace with new fuse if necessary.

**FOR FURTHER ASSISTANCE CONTACT:
MCE Technical Support**

MCE Load Weigher

The MCE Load Weigher is designed for use with isolated platform elevator cars. The accuracy of the load weigher depends on the condition of the rubber isolation pads. If they are old, cracked or hard, the performance of the load weigher will suffer. Similarly, if the wrong pad material is used, the deflection (with load) can be incorrect. Please refer to “Verify Performance” on page 5-68 to verify the performance of the pads. There are three potential sensor installation methods:

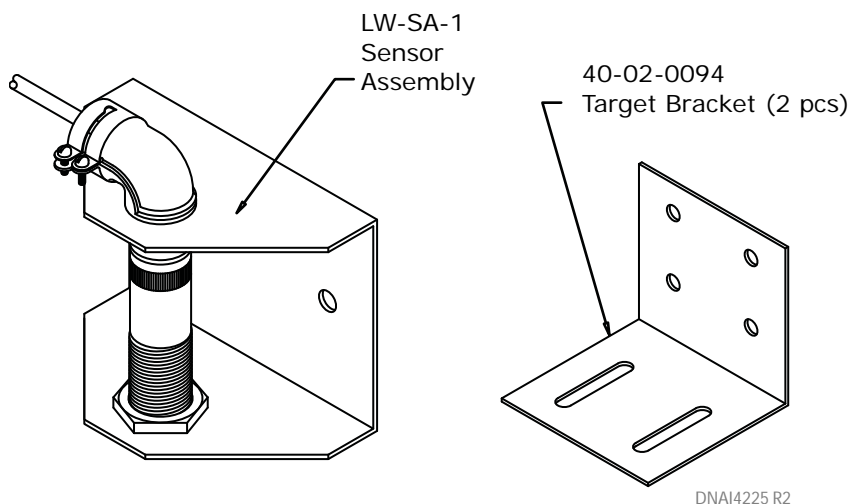
- Method #1: New or replacement installation with target bracket near the middle bottom of the floor. Please refer to “Center of Gravity vs. Center of Floor” on page 5-64 (preferred method).
- Method #2: Replacement installations re-using the original load weigher location for target bracket. Please refer to “Installation Method # 2” on page 5-69.
- Method #3: Sensor on top of the car (predisposes sensor to damage and adjustment problems). Please refer to “Installation Method # 3” on page 5-69



Caution

Increasing the weight in the car must always increase clearance between the proximity sensor and the target for proper operation.

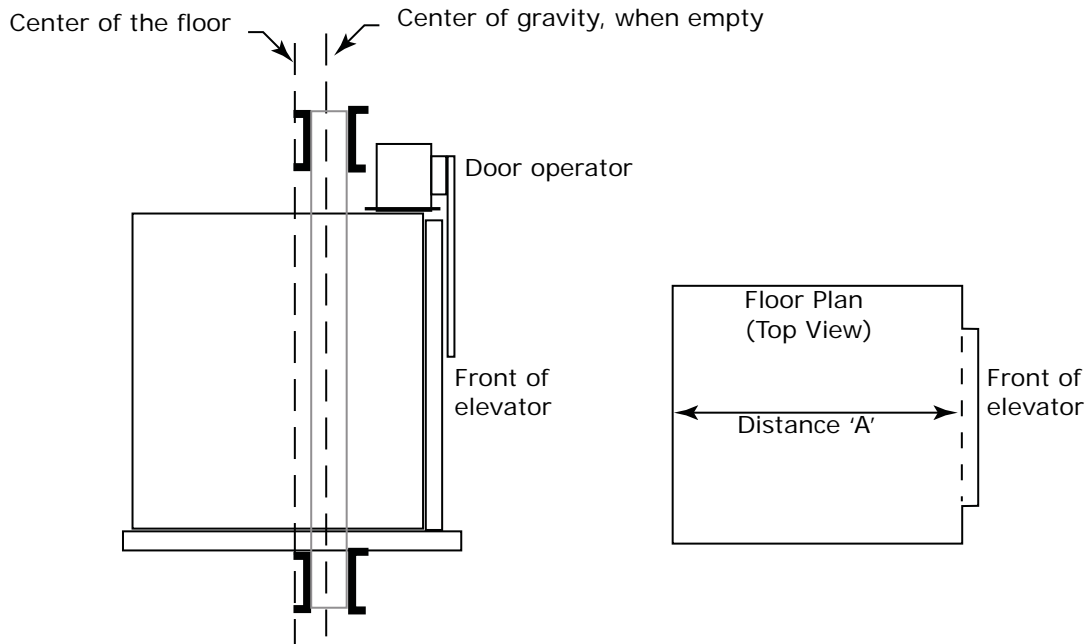
Figure 5.1 MCE Load Weigher



Installation Method #1 — Preferred

When installing, remember that the car is supported near the center of gravity. The center of gravity may be offset towards the front of the car to compensate for door operator weight unless the car has *both* front and rear doors. Install the target bracket as close to the center of the floor as possible.

Figure 5.2 Center of Gravity vs. Center of Floor



To measure the compression of the rubber pads and not the sagging of the floor – attach a structural piece such as a 1 ½” by 1 ½” angle to the outside edges of the floor.

Figure 5.3 Sensing the Edges of the Floor (compensation for floor sag)

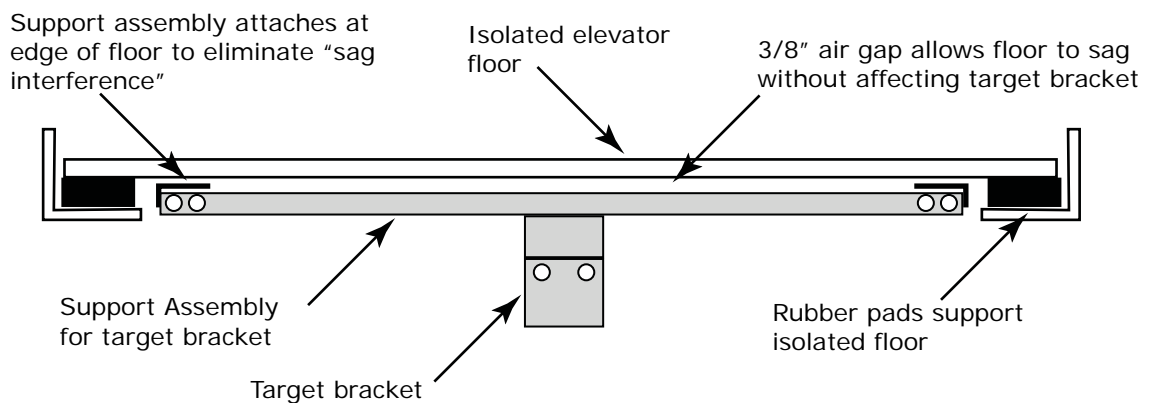
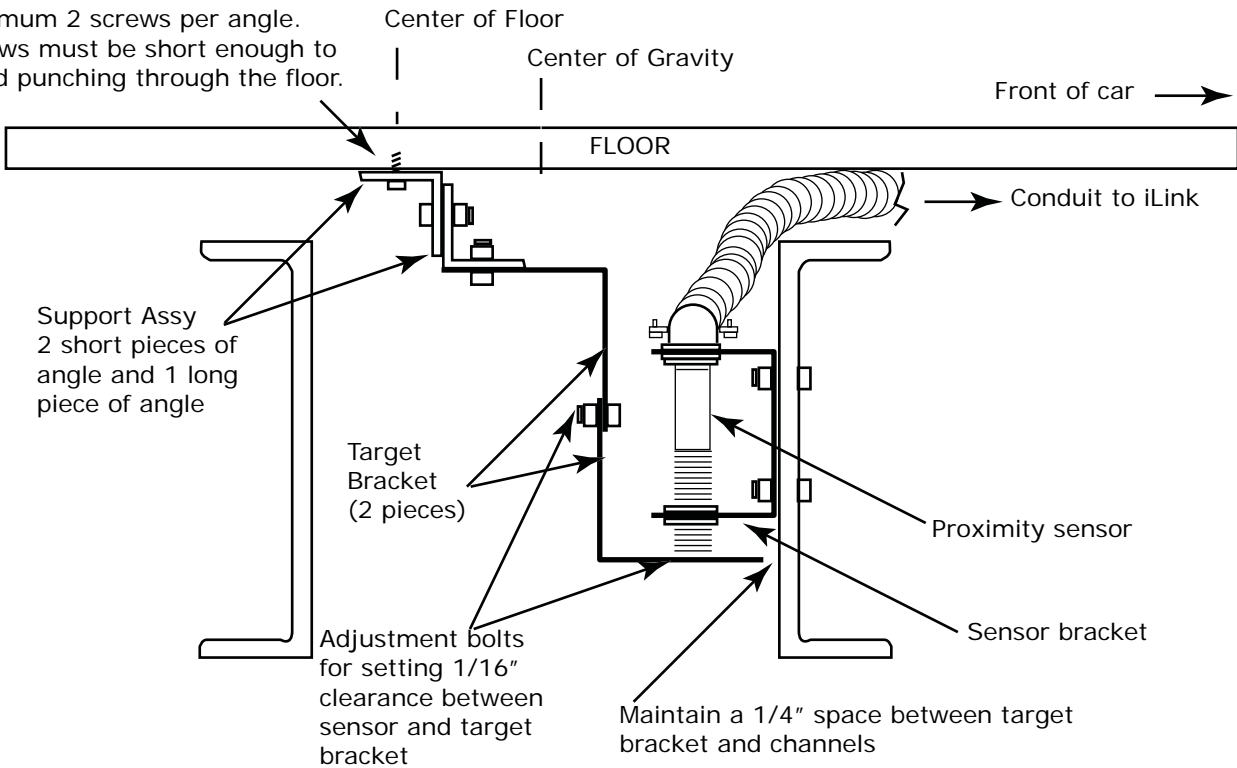


Figure 5.4 Target Bracket and Sensor mounted on Support Assembly and Car frame

These screws hold the 2 small angles to the bottom of the floor - minimum 2 screws per angle. Screws must be short enough to avoid punching through the floor.



Note

The position sensed is where the support assembly for the target bracket is attached to the floor, NOT where the sensor is located.

If the distance between where the target bracket attaches to the floor and the center of the floor is greater than 20% of distance “A” (see Figure 8.2), an alternate mounting method may produce better results.

- **Example:** If distance “A” is 10'
 Then 20% of 10' is 2'
 Therefore, if the target bracket attaches to floor more than 2' from the center of the channel, an alternate method of mounting is suggested (see Figure 8.5).

Figure 5.5 Alternate Mounting Location for Sensor and Target

When mounting inside the channel is too great a percentage (+20%) of Distance ‘A’ try mounting sensor outside the channel.

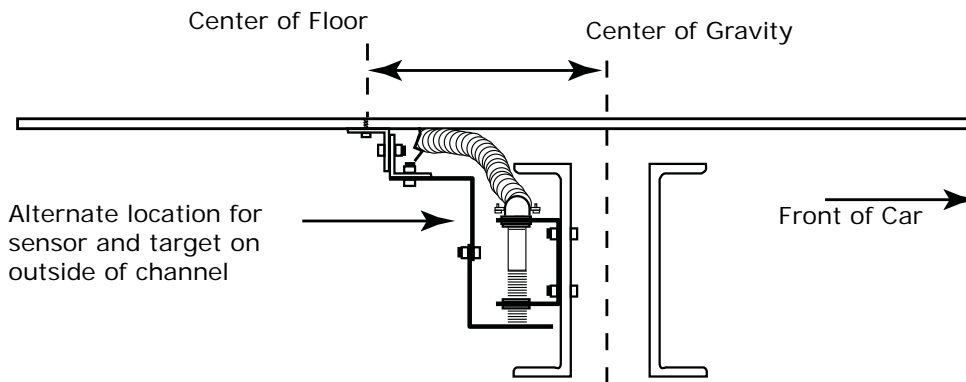
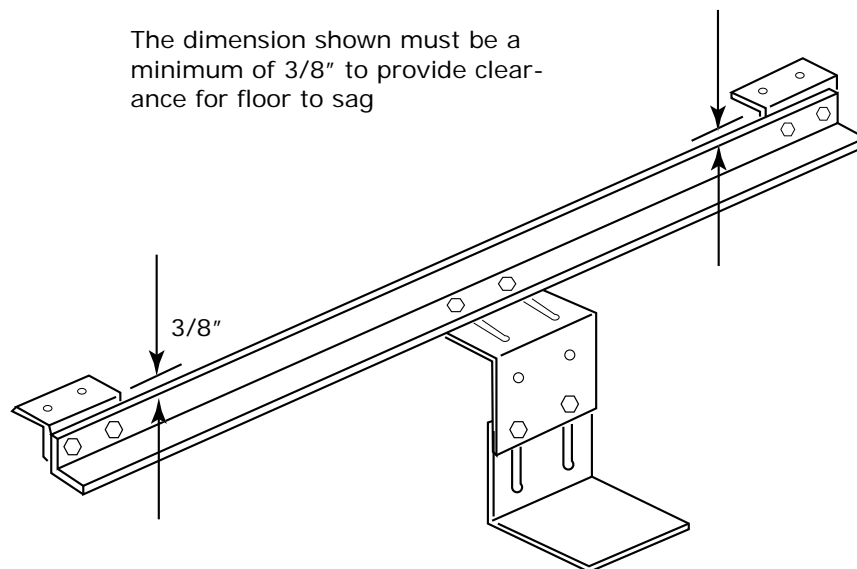


Figure 5.6 Typical Support Assembly for Target Bracket



Method #1 Installation Instructions

Installation consists of:

- Making a support assembly
- Mounting the target bracket on the support assembly
- Mounting the support assembly
- Mounting the proximity sensor
- Connecting the wiring
- Adjusting the amplifier (iLink car top box)
- Verifying performance
- Adjusting iControl parameters
- Maintenance recommendations

The Support Assembly

1. Cut a piece of 1 ¼" x 1 ¼" or 1 ½" x 1 ½" steel angle to span the width of the floor as shown in Figures 8.3 and 8.6.
2. Cut two more 2" lengths of angle to attach the long piece as close as possible to the outer edge of the floor. When attaching the angles together, provide 3/8" clearance to allow for floor sagging (see Figure 8.6).

Mount the Target Bracket

1. Bolt the two-piece target bracket in the middle of the support assembly so that the slots allow the target to be adjusted (see Figure 8.6).

Mount the Support Assembly

1. The support assembly attaches to the bottom of the floor of the isolated platform as close to the outside edge as possible, preferably attaching between the two channels comprising part of the safety plank (see Figure 8.4). Hold the support assembly for the proper 1/4" spacing between the target bracket and the channel shown in Figure 8.4 where the sensor will be mounted and mark the holes to drill to attach the support assembly to the floor. Be sure to leave room for the sensor and mounting bracket.
2. Drill the holes and mount the support assembly.
3. Verify the target bracket to channel space is still 1/4" (1/8" to 3/4" after mounting).

Mount the Proximity Sensor

1. Mount the proximity sensor and bracket on the channel closest to the front of the car. Center the sensor over the target with about 1/16" (or less) space between the target and sensor (see Figure 8.4).

Connect the Wiring

1. Connect proximity sensor wires to iLink CTP board terminals.
 - For Square D/Telemecanique Sensor Part # XSP-H08362 the color coding is:
Brown sensor wire to +26V terminal
Black sensor wire to LW+ terminal
Blue sensor wire to LW- terminal



Adjust the Amplifier

1. Before adjusting the sensor amplifier the following conditions must first be met:
 - Power to the controller
 - The car is on Inspection operation
 - The brake is already adjusted to hold 125% of full load
 - The elevator is positioned level with the floor and with doors open so test weights may be added and removed
2. With the car empty, adjust the clearance between sensor and target so that 0.3 to 1.0VDC is present between test points LW+ to LW- on the iLink CTP board. This is a sensitive apparatus, so hold the target while loosening the adjustment bolts of the target, make the adjustment, and tighten the bolts. (Increasing the distance between the target and the sensor increases the voltage; decreasing distance decreases the voltage.)
3. Remove all personnel from the pit (in case the car moves when fully loaded) and put 100% of load in the car.
4. Set the LW ADJ trimpot on the CTP (cartop) board fully clockwise and check that there is LESS THAN 14VDC between test points TP LW and GND.
5. Adjust the LW ADJ trimpot so that there is no more than 8VDC and no less than 4VDC between TP LW and GND (8VDC recommended).

Verify Performance

1. Check the voltages measured between test points LW+ and LW- with the following loads. This information is used to verify rubber pad resilience for the isolation platform. Document the data below.

Table 5.7 Verify MCE Load Weigher Performance

	Load in pounds	Volts across LW+ to LW-	Voltage increase
No load		(1)	
1/4 of full load		(2)	(2)-(1)
1/2 of full load		(3)	(3)-(2)
3/4 of full load		(4)	(4)-(3)
Full load		(5)	(5)-(4)

The variation between voltage increase entries should be linear. If voltage increase is more than 25% different from the entry just above it, check the following:

- Condition of rubber pads
- Voltage variance when weight is in center of car vs. on edge of car (sagging problem)

Adjust iControl Parameters The load weigher is now installed and properly adjusted. However, the parameter adjustments for the load weigher must be completed. [Please refer to “Load Weigher Configuration” on page 4-32.](#)

Recommended Maintenance Once a month, check the voltage between LW+ and LW-. It should be within 0.3V and 1.0VDC **when the car is empty**. If the voltage is outside the 0.3 to 1.0VDC range, adjust the target bracket.

Additionally, periodic checks of the voltage increase with varying load conditions will help diagnose when the rubber pads begin to lose elasticity.

Installation Method # 2

1. Re-use pre-existing holes or brackets to mount sensor and target.
2. When using supports created for other load weighers, be sure to arrange sensor and target so that increasing the weight in the car increases the clearance between the proximity sensor and the target.
3. Always use the target bracket for the target as it will flex slightly and not damage the sensor during any rebound while doing a buffer test, etc.
4. If the voltage between LW+ and LW- varies depending on **where** the weight is in the car, use Installation Method #1 instead.

Installation Method # 3

- Mount the sensor on the top of the car. This has the advantage of being the most convenient location, both for installation and for later adjustment. However, there are disadvantages to this approach as well.
 - The first is that the sensor and target bracket are usually more exposed to accidental physical damage (critical because the system depends on precise clearances between the sensor and target).
 - Second, since the inclination of most installers would be to mount the target directly to the top of the cab, the extra weight of an elevator adjuster on the cartop often creates problems during adjustment or if they happen to be riding there temporarily during normal operation, especially since the top of the cab is not as structurally rigid as the floor.

Note

If locating the load weigher on the car top is necessary, better results can be obtained by making up a target bracket assembly similar to Figure 8.6 and attaching it to the edges of the elevator cab, making it less sensitive to cab top flexing. Then, mount the sensor so it is supported by the crosshead. This can give a very good result, but requires additional expertise on the part of the installer.

5



Caution

When mounting the sensor on top of the car, be sure to arrange the sensor and target bracket so that increasing the weight in the car increases the clearance between the proximity sensor and the target.





Quick Topics

- [About Troubleshooting](#)
- [Troubleshooting Tools](#)
- [Safety String Bypass](#)
- [iControl Messages](#)
- [iControl Circuit Boards](#)
- [Circuit Board QRs](#)
- [Serial COP Diagnostics](#)
- [iLink Diagnostics](#)



Troubleshooting



About Troubleshooting

This section contains general troubleshooting related information and tabled information to help you diagnose and correct iControl problems. If you are viewing this on a computer, click the page number to jump to the appropriate section.

Troubleshooting Topics	Description	See
Troubleshooting Tools	Lists the troubleshooting tools available.	page 6-2
Safety String Bypass Jumper	Temporarily bypasses an open safety string.	page 6-3
iControl Messages	Fault and status messages table - includes a description, car reaction and troubleshooting tips for each message.	page 6-13
Replacing Circuit Boards and Assemblies	Instructions for removing and replacing circuit boards or the iBox.	page 6-79
Circuit Board Quick References	Descriptions of circuit board connections, indicators, jumpers and test points.	page 6-82
COP Board Diagnostics	Use to diagnose problems with Serial COP boards.	page 6-83
iLink Cartop Diagnostics	Use to diagnose problems with iLink.	page 6-89

Troubleshooting Tools

The iBox provides status and trouble shooting information:

- The status line of the iBox display scrolls messages about system operation. [Please refer to “LCD Display and Keypad” on page 7-3.](#)
- The iBox Event Log captures a FIFO file of the last 50 system events by event number and name, and provides additional data for each event captured. Press softkey (1) beneath the *Car* label, scroll down to *View Event Log* and press Enter. To view event details, scroll to the desired event and press Enter. *Scroll down to see all of the data, including the event name.* A description and troubleshooting suggestions for each event can be found in iView online Help (Help > iView Help > Messages Reference) and in the iControl Messages table in this user guide. [Please refer to “iControl Messages” on page 6-13.](#)

iView provides an extensive toolset to help you diagnose problems, including:

- **Hoistway:** The Hoistway window (Controller > View > Hoistway) shows the current position of the car in the hoistway, the calls registered, the car speed and the current operating mode. [Please refer to “Hoistway window” on page 9-4.](#)
- **Operational Status tab:** The Operational Status tab shows the current speed, position, pattern, and motion of the car. Also, the status of the Safety and Cartop processors, safety circuits, leveling sensors and door locks is shown. The Faults and Car status text boxes show general and car operation faults and car status so that you can monitor them easily while viewing hoistway information and running the car. A description and troubleshooting suggestions for each fault or status message can be found in iView online Help (Help > iView Help > Messages Reference) and in the iControl Messages table in this user guide. [Please refer to “iControl Messages” on page 6-13.](#)
- **Event Log:** The Event Log tab (View > Diagnostics > Event Log) monitors and records system events. You can easily save event log information to a file on your iView PC for archival and future reference. A description and troubleshooting suggestions for each event can be found in iView online Help (Help > iView Help > Messages Reference) and in the iControl Messages table in this user guide. [Please refer to “iControl Messages” on page 6-13.](#)
- **Fault Bypass:** The Fault Bypass tab (View > Diagnostics > Fault Bypass) allows you to bypass over 50 system faults. The Fault Bypass switch on the iBox must be ON and each fault bypass times out after fifteen minutes to prevent the possibility of unintended, long term bypassing of a critical faults. To bypass faults, the car must be on Machine Room Inspection or Test Operation. [Please refer to “Diagnostics - Fault Bypass” on page 9-17.](#)
- **Diagnostic Flags:** The Diagnostic Flags tab (View > Diagnostics > Diagnostic Flags) allows you to view system diagnostic flags and car statuses in four classifications (Operation, Motion, Safety, Drive). [Please refer to “Diagnostics - Diagnostic Flags” on page 9-12.](#)
- **Terminal Switches Status:** The Terminal Switches Status tab (View > Diagnostics > Terminal Switches Status) shows information about the speed and position of the car when each Normal and Emergency Terminal Switch opened. [Please refer to “Diagnostics - Terminal Switches Status” on page 9-19.](#)
- **Diagnostic Outputs:** Diagnostic Outputs (View > Diagnostics > Diagnostic Outputs window) allows you to choose and simultaneously monitor up to 16 system outputs on screen. [Please refer to “Diagnostics - Diagnostic Outputs” on page 9-13.](#)
- **Virtual Oscilloscope:** The oscilloscope (View > Diagnostics > Virtual Oscilloscope) allows you to select and view two system outputs simultaneously on a “virtual oscilloscope.” [Please refer to “Diagnostics - Virtual Oscilloscope” on page 9-21.](#)

Safety String Bypass Jumper

If any switch or relay in the safety string opens, the car immediately loses power and stops. In some situations, you may need to temporarily bypass an open safety string to move the car so that the safety string can once again be “made up.” For example, if the car has tripped a final limit, you will need to bypass the safety string and move the car up (or down) the hoistway past the limit switch so that the safety string can again be completed. Once the safety string is complete again, you must immediately remove the bypass jumper.

The safety string bypass location for iControl is accessed through ports on the front cover of the iBox. The ports are sized so that a jumper wire (16AWG minimum) with insulated clips on each end can be used to short the SB and 3 terminals to bypass the safety string.



Danger

You are jumpering 110VDC. Place the jumper with caution, being certain that you are insulated from the possibility of electrical shock.

The safety bypass circuitry is intelligent. The jumper will have no effect if it is put in place with the safety string intact (other than to generate a time out after 15 minutes pass). The jumper will bypass the string and allow the car to be moved only if it is placed after the safety string has opened. **If the jumper is in place when the string opens, you must remove the jumper, then replace it before it will bypass the string.**

The jumper is monitored by a timer. If the jumper is in place for longer than 15 minutes, the timer will expire, drop the brake and motor contactors and generate a Safety Bypass Jumper Time Out. To clear the fault and restart the car, you must remove the bypass jumper. If more time is needed, re-install the jumper and the fifteen-minute timer will restart.

The table below specifies what is and is not bypassed by the jumper.

Table 6.1 Safety String Bypass Jumper

Bypasses	Does not bypass
Cartop exit input	Rope Gripper OK from Rope Gripper board
Emergency Stop switch on car	Unintended motion fault already tripped
Governor switch input	Rope brake fault already tripped
Hoistway safety string	Machine Room Emergency Stop switch
Car safety string	Any Safety Processor A or B fault

Message Tables

Almost all troubleshooting begins with examining system messages. System outputs are displayed alternating with other messages on the iBox LCD. Status, Fault, and Event messages are displayed by iView. (iBox maintains an Event Log as well.) This section contains two tables. Table 7.2 provides a cross-reference from iBox ID numbers to the associated iControl message name. Table 7.3 lists system messages in alphabetical order and describes the cause and recommended troubleshooting procedures if appropriate.

Table 6.2 Cross Reference: iBox Event Log ID Numbers to iControl Messages

ID #	iControl Message (iBox Event Log and iView Controller Event Log)
1	Drive On Fault (was Drive Ready On Fault)
2	Brake Enable Fault
4	Insufficient Brake Feedback Fault
5	Brake Voltage Not On Fault
6	Excessive Brake Feedback Fault
7	Brake Pick Fault
8	Brake Module Over Temperature Fault
9	Heat Sensor Fault 2
10	Heat Sensor Fault 3
11	Heat Sensor Fault 4
12	Power Supply Fault 1
13	Power Supply Fault 2
14	Power Supply Fault 3
15	Power Supply Fault 4
16	Drive At-Speed Fault
17	Drive Fault
18	Drive Ready Fault
19	Front Door Close Time-out
20	Front Door Close Fault
21	Front Door Open Time-out
22	Front Door Open Fault
23	Rear Door Close Time-out
24	Rear Door Close Fault
25	Rear Door Open Time-out
26	Rear Door Open Fault
27	Earthquake Operation (Seismic Switch)
28	Earthquake Operation (Counterweight)
29	Earthquake Run
30	Earthquake Operation Activated
31	Earthquake Operation Deactivated
32	Earthquake Emergency Stop
33	Fire Service Recall Main
34	Fire Service Recall Alternate
35	Fire Service In-car Activated
36	Elevator Recall Operation (Switch 1)
37	Elevator Recall Operation (Switch 2)
38	Elevator Recall Operation (Switch 3)
39	Elevator Recall Operation (Switch 4)
40	Elevator Recall Operation (Switch 5)
41	Elevator Recall Operation (Switch 6)
42	Emergency Power Recall
43	Emergency Power Shutdown

ID #	iControl Message (iBox Event Log and iView Controller Event Log)
44	Emergency Power Run
45	Front Door Contact Fault
46	Rear Door Contact Fault
47	Front Photo Eye Failure
48	Front Safe Edge Failure
49	Rear Photo Eye Failure
50	Rear Safe Edge Failure
51	Cartop Inspection Operation
53	Hoistway Access Operation
54	Machine Room Inspection Operation
55	Test Mode
56	Capture Mode
57	Independent Service
60	Attendant Service
61	Passenger Operation
62	Up Normal Terminal Switch 1 Position Fault
63	Up Normal Terminal Switch 2 Position Fault
64	Up Normal Terminal Switch 3 Position Fault
65	Up Normal Terminal Switch 4 Position Fault
66	Up Normal Terminal Switch 5 Position Fault
67	Up Emergency Terminal Switch Position Fault
68	Down Normal Terminal Switch 1 Position Fault
69	Down Normal Terminal Switch 2 Position Fault
70	Down Normal Terminal Switch 3 Position Fault
71	Down Normal Terminal Switch 4 Position Fault
72	Down Normal Terminal Switch 5 Position Fault
73	Down Emergency Terminal Switch Position Fault
74	Position Quadrature Fault
75	Position Speed Threshold Fault
76	Position Speed Deviation Fault
77	Motion Start Fault
78	User code accessing an invalid logical indicator (internal event)
79	Car shut down due to emergency power operation with no supervisor (Activated)
80	Car shut down due to emergency power operation with no supervisor (Deactivated)
81	Car delayed with doors open
82	Car delayed with doors closed
83	Car out of service with doors open
84	Car out of service with doors closed
85	Earthquake board power supply ON
86	Earthquake board power supply OFF
87	Earthquake reset button stuck ON
88	Earthquake reset button OK
89	Fire Service In-car Hold Operation
90	Fire Service In-car Recall Operation
91	Load learn process activated
92	Load learn process deactivated
93	Car Heavy Load Activated - Hall Calls Bypassed
94	Car Over Load Activated
95	Fire Service Recall Deactivated
96	Fire Service In-car Deactivated
97	Emergency Power Activated



ID #	iControl Message (iBox Event Log and iView Controller Event Log)
98	Emergency Power Deactivated
100	Car Dispatch Load
102	Car Heavy Load - Deactivated
104	Car Over Load Deactivated
105	Photo Eye Antinuisance
106	Light Load Antinuisance
107	Nudging Operation
108	Front Photo Eye Bypassed
109	Rear Photo Eye Bypassed
110	Front Safe Edge Bypassed
111	Rear Safe Edge Bypassed
118	Inspection Overspeed Fault
119	Tach Error Fault
120	Drive Enable Feedback Fault
121	Safety A Inspection Overspeed Fault
122	IO Map Compare Fault
123	IO Map Toggle Compare Fault
124	Fault Bypass Switch Timed Out
125	Safety Bypass Jumper Timed Out
126	Learn Switch Timed Out Fault
127	Safety A SIB Device Fault
128	Safety B SIB Device Fault
129	OPRAM Device Error
130	EEPROM Device Error
131	Front Door Open Button Bypassed
132	Rear Door Open Button Bypassed
135	Door Lock Clipped Greater than 200fpm
136	Safety String Open
137	Motion stopped due to IO toggle test
138	Safety Configuration Mismatch
139	Safety Configuration Learn Fault
140	IO Map Compare Alert
141	Safety A Contract Overspeed Fault
142	Safety A Inspection Leveling Overspeed Fault
143	Safety Inventory Checksum Fault
144	Safety Configuration Checksum Fault
145	Limit Switches Checksum Fault
146	Safety Configuration Inventory Cross Check Fault
147	Safety Inventory Learn Fault
148	Limit Switches Learn Fault
149	Dual Channel QUAD Fault
150	Single Channel QUAD Fault
151	Loss of Position or Speed Indicators
152	Safety Inventory Comparison Fault
153	Safety Inventory Creation Fault
154	Position Quadrature Reversed Fault
155	Down Normal Terminal Switch 1 Level 1 Speed Fault
156	Down Normal Terminal Switch 2 Level 1 Speed Fault
157	Down Normal Terminal Switch 3 Level 1 Speed Fault
158	Down Normal Terminal Switch 4 Level 1 Speed Fault
159	Down Normal Terminal Switch 5 Level 1 Speed Fault
160	Down Normal Terminal Switch 1 Level 2 Speed Fault

ID #	iControl Message (iBox Event Log and iView Controller Event Log)
161	Down Normal Terminal Switch 2 Level 2 Speed Fault
162	Down Normal Terminal Switch 3 Level 2 Speed Fault
163	Down Normal Terminal Switch 4 Level 2 Speed Fault
164	Down Normal Terminal Switch 5 Level 2 Speed Fault
165	Up Normal Terminal Switch 1 Level 1 Speed Fault
166	Up Normal Terminal Switch 2 Level 1 Speed Fault
167	Up Normal Terminal Switch 3 Level 1 Speed Fault
168	Up Normal Terminal Switch 4 Level 1 Speed Fault
169	Up Normal Terminal Switch 5 Level 1 Speed Fault
170	Up Normal Terminal Switch 1 Level 2 Speed Fault
171	Up Normal Terminal Switch 2 Level 2 Speed Fault
172	Up Normal Terminal Switch 3 Level 2 Speed Fault
173	Up Normal Terminal Switch 4 Level 2 Speed Fault
174	Up Normal Terminal Switch 5 Level 2 Speed Fault
175	Safety A DETS Level 2 Speed Fault
176	Safety A UETS Level 2 Speed Fault
177	Excessive Faults Shutdown
178	Safety A Unintended Motion Fault
179	Ascending Car Overspeed Fault
180	Position Synchronization Required at Terminal
181	Position Synchronized at Terminal
182	Position Synchronization Required at Floor
183	Position Synchronized at Floor
184	Cartop Communication Fault
185	Cartop Inspection Unintended Motion Fault
186	Cartop Automatic Unintended Motion Fault
187	Motor Limit Timed Out
188	Safety B Fault Bypass Switch Timed Out
189	Safety B Safety Bypass Jumper Timed Out
190	IO Map Compare Long Term Alert
191	IO Map Compare Long Term Fault
192	Position Location Error Fault
193	Position Cartop Offset Fault
194	Motor Contactor Driver Proofing Fault
195	Motor Contactor Proofing Fault
196	Brake Contactor Driver Proofing Fault
197	Brake Contactor Proofing Fault
198	Safety B UETS Level 2 Speed Fault
199	Safety B DETS Level 2 Speed Fault
200	Safety B Inspection Overspeed Fault
201	Safety B Inspection Leveling Overspeed Fault
202	Safety B Contract Overspeed Fault
203	Excessive Relevels Fault
204	Excessive Restarts Fault
205	Cartop Emergency Stop
206	Cartop Power Loss
207	Up Direction Limit Open
208	Down Direction Limit Open
209	Floor Location Fault
210	Floor Sensor Fault
211	Power Transfer Input Activated
212	Power Transfer Input Deactivated

ID #	iControl Message (iBox Event Log and iView Controller Event Log)
213	Invalid Front Door Position
214	Invalid Rear Door Position
215	Earthquake Reduce Speed
216	Cartop Inspection Operation
217	Car Panel Inspection Operation
218	Hoistway Access Inspection Operation
219	Machine Room Inspection Operation
220	Inspection Operation
221	Construction Cartop Inspection Operation
222	Construction Car Panel Inspection Operation
223	Construction Hoistway Access Inspection Operation
224	Construction Machine Room Inspection Operation
225	Construction Inspection Operation
226	Door Lock Clipped Less than 200fpm
227	Invalid Input
228	Emergency Medical Service Recall Activated (Switch 1)
229	Emergency Medical Service In-Car Activated (Switch 1)
230	Emergency Medical Service Deactivated
231	Emergency Medical Service Bypassed
232	SCR Power Supply Fault
233	SCR AC Phase Fault
234	SCR Contactor Fuse Fault
235	SCR Phase Lock Loop Fault
236	SCR Phase Lock Loop Warning
237	SCR Dynamic Brake Fault
238	SCR Instantaneous Over Current
239	SCR Armature Voltage On
240	SCR High Temperature Fault
241	SCR Loop Over Current
243	SCR Insufficient Armature Current
244	SCR Excessive Armature Current
245	SCR Excessive Current Command, Drive Enabled
246	SCR Excessive Current Command, Drive Disabled
247	Insufficient Motor Field Forcing Feedback Fault
248	Insufficient Motor Field Feedback Fault
249	Swing Operation Activated
250	Swing Operation Deactivated
251	Field Module Over Temperature Fault
252	Speed Limit, MF Forcing
253	Tach Failure
254	Sabbath Operation Activated
255	Sabbath Operation Deactivated
256	Emergency Brake Tripped
257	Landing System Sensor Fault
258	Emergency Brake Leg 1 Short Fault
259	Emergency Brake Leg 2 Short Fault
260	Alternate Speed Profile 1 Activated
261	Alternate Speed Profile 1 Deactivated
262	Alternate Speed Profile 2 Activated
263	Alternate Speed Profile 2 Deactivated
264	Motor Field Forcing Timed Out
265	iView Logged On

ID #	iControl Message (iBox Event Log and iView Controller Event Log)
266	iView Logged Off
267	iView Timed Out
268	iView Lost Connection
269	Balanced Mode
270	Lobby Peak Mode
271	Demand Up Peak Mode
272	Demand Down Peak Mode
273	CFSS Mode 1 Recall Activated
274	CFSS Mode 1 at Floor Activated
275	CFSS Mode 1 In-car Activated
276	CFSS Mode 2 Recall Activated
277	CFSS Mode 2 at Floor Activated
278	CFSS Mode 2 In-car Activated
279	Emergency Alarm Acknowledged
280	Emergency Alarm Activated (Safety opened)
281	Emergency Alarm Activated (Car delayed with doors closed)
282	Emergency Alarm Activated (Alarm button)
283	Emergency Alarm Activated (In-car stop switch)
284	Emergency Brake OK open
285	Cartop Exit Open
286	Governor open
287	Safety H String Open
288	Safety C String Open
289	Machine Room Stop Switch Open
290	Car Stop Switch Open
291	Controller Main Computer Startup
292	Floor Synchronization Fault
293	Terminal Synchronization Fault
294	Position Synchronization Fault
296	Up Emergency Terminal Switch Shutdown
297	Down Emergency Terminal Switch Shutdown
298	Power Up Position Synchronization Required at Terminal
299	Learn U/DNT1-5 and U/DETS Speeds
300	Learn U/DNT1-5 and U/DETS Positions
301	Excessive Motor Field Feedback Fault
302	Brake Output Circuit Failure
303	Group Communication Lost
304	Group Communication Established
305	Flood Operation Activated
306	Flood Operation Deactivated
307	Emergency Brake UIM Reset Button Stuck
308	Exercise Operation Activated
309	Exercise Operation Deactivated
310	SCR Low Line Fault
311	SCR Low Line Caution Activated
312	SCR Low Line Caution Deactivated
313	SCR Low Line Test Fault
314	Excessive Restarts Warning
315	Governor Speed Reduction Switch Fault
316	Software Recall Switch Activated
317	SCR Drive Ready Fault
318	Retiring Cam Door Lock Fault Activated



ID #	iControl Message (iBox Event Log and iView Controller Event Log)
319	Retiring Cam Door Lock Fault Deactivated
320	Retiring Cam Protection Fault Activated
321	Retiring Cam Protection Fault Deactivated
322	Watchdog Ordered Control Stop Before Reset
323	Front Hall Door Open Button Bypassed
324	Rear Hall Door Open Button Bypassed
327	Bus 2 Fuse Open
328	Bus 2D Fuse Open
329	Bus 2MC Fuse Open
330	Bus 2PI Fuse Open
331	Bus 3 Fuse Open
332	Bus 3HA Fuse Open
333	Watchdog Ordered Emergency Stop Before Reset
334	Local Dispatcher Activated
335	Local Dispatcher Deactivated
336	Drive Start Failure
337	Emergency Medical Service Recall Activated (Switch 2)
338	Emergency Medical Service In-Car Activated (Switch 2)
339	Pre-start Door Lock Fault
340	Emergency Alarm Deactivated without Acknowledgement
341	Cartop Exit no Counterweight Configuration Error
342	Front Door Close Fault Recovery Failure
343	Rear Door Close Fault Recovery Failure
344	Sheave Brake Pick Fault
345	Sheave Brake Drop Fault
346	Serial COP Buss 1 Comm Fault
347	Serial COP Buss 2 Comm Fault
348	Serial COP Buss 3 Comm Fault
349	Serial COP Buss 4 Comm Fault
350	Serial COP Bus 1 Inventory Fault
351	Serial COP Bus 2 Inventory Fault
352	Serial COP Bus 3 Inventory Fault
353	Serial COP Bus 4 Inventory Fault
354	User Defined Event 1 On
355	User Defined Event 1 Off
356	User Defined Event 2 On
357	User Defined Event 2 Off
358	User Defined Event 3 On
359	User Defined Event 3 Off
360	User Defined Event 4 On
361	User Defined Event 4 Off
362	User Defined Event 5 On
363	User Defined Event 5 Off
364	User Defined Event 6 On
365	User Defined Event 6 Off
366	User Defined Event 7 On
367	User Defined Event 7 Off
368	User Defined Event 8 On
369	User Defined Event 8 Off
370	User Defined Event 9 On
371	User Defined Event 9 Off
372	User Defined Event 10 On

ID #	iControl Message (iBox Event Log and iView Controller Event Log)
373	User Defined Event 10 Off
374	Drive Communication Fault
375	Drive Communication Warning
376	Motor Limit Protection Timer Elapsed
377	Shuttle Service Activated
378	Shuttle Service Deactivated
379	Event Log Cleared
380	Front Auxiliary Door Open Button Bypassed
381	Rear Auxiliary Door Open Button Bypassed
382	Backup Power Unit Failure Activated
383	Backup Power Unit Failure Deactivated
384	Backup Power Direction Reversal
385	Backup Power Recall ON
386	Backup Power Recall OFF
387	Machine Room Heat Detectors Activated
388	Machine Room Heat Detectors Deactivated
389	Hoistway Heat Detectors Activated
390	Hoistway Heat Detectors Deactivated
391	Floor Heat Detectors Activated
392	Floor Heat Detectors Deactivated
393	Heat Detectors Recall Activated
394	Heat Detectors Recall Deactivated
395	Heat Detectors Recall Complete
396	Brake Drop Fault
397	Cartop Communication Established
398	Hall Call Service Disabled
399	Hall Call Service Enabled
400	Nudging Front
401	Nudging Rear
402	Emergency Dispatch On
403	Emergency Dispatch Off
404	Safety B Unintended Motion Fault
405	SPA Spare Event 1
406	SPA Spare Event 2
407	SPA Spare Event 3
408	SPA Spare Event 4
409	SPA Spare Event 5
410	SPA Spare Event 6
411	SPA Spare Event 7
412	SPA Spare Event 8
413	LCD Fault
414	Battery Voltage Low-IMP
415	Emergency Brake OK open Off
416	Safety H String Open Off
417	Safety C String Open Off
418	Cartop Exit Open Off
419	Brake Pick Switch Fault Off
420	IO Map Compare Fault Off
421	IO map Toggle Compare Fault Off
422	Safety A SIB Device Fault Off
423	Safety B SIB Device Fault Off
424	Invalid Configuration Input Off

ID #	iControl Message (iBox Event Log and iView Controller Event Log)
425	Invalid Configuration Input DLMS
426	Invalid Configuration Input DLAT
427	Invalid Configuration Input DLAB
428	Invalid Configuration Input DCMS
429	Invalid Configuration Input DCAT
430	Invalid Configuration Input DCAB
431	Invalid Configuration Input DPM
432	Invalid Configuration Input CTEX
433	Invalid Configuration Input DLMSR
434	Invalid Configuration Input DCMSR
435	Invalid Configuration Input DPMR
436	Safety String Closed
437	IMP Switch Fault - Emergency Stop
438	IMP Switch Fault - Fault Bypass
439	IMP Switch Fault - Inspection DOWN
440	IMP Switch Fault - Inspection UP
441	IMP Switch Fault - Inspection Enable
442	IMP Switch Fault - Inspection
443	IMP Switch Fault - Learn
444	IMP Switch Fault - Test
445	IMP Switch Fault - Write Enable
446	IMP Switch Fault - Hoistway Door Bypass
447	IMP Switch Fault - Car Door Bypass
448	IMP Switch Fault - None
451	Excessive Faults Warning
452	Stuck Cartop Inspection Input
453	Cartop Inspection Inputs OK
454	Stuck Car Panel Inspection Input
455	Car Panel Inspection Inputs OK
456	Cartop Inspection Disabled
457	Cartop Inspection Enabled
458	Hoistway Access Disabled
459	Hoistway Access Enabled
460	Car Panel Inspection Disabled
461	Car Panel Inspection Enabled
462	Machine Room Inspection Disabled
463	Machine Room Inspection Enabled
464	Stuck Inspection Input Fault
465	DBD Mode Activated (not used)
466	ETA Mode Activated (not used)
467	Hall Call Bypass Input ON
468	Hall Call Bypass Input OFF
469	Capture Input ON
470	Capture Input OFF

iControl Messages

Table 6.3 iControl Messages

iControl Messages
Alternate Floor Smoke Sensor Recall, ALTERNATE FLOOR SMOKE
Description: Recall to the main fire floor due to active or latched smoke detector input(s) from floors other than the main recall floor.
Car Reaction: Car proceeds to the user-defined main fire recall floor. Once at the recall floor, door operation is according to the user-defined door operation under fire recall operation.
Troubleshooting: <ol style="list-style-type: none"> 1. If in error, inspect the sensor input and connections. 2. Related Inputs: Smoke and fire sensors as indicated in job prints.
Alternate Speed Profile 1 Activated, Alternate Speed Profile 1, ALT SPEED PROFILE 1
Description: Indicates that the Alternate Speed Profile has been enabled via a keyed or switched input. When so configured, Alternate Speed Profiles 1 and 2 use Alternate 1 and Alternate 2 performance patterns respectively. (Pattern Configuration/Alternate 'n'.)
Car Reaction: Car uses assigned pattern (Alternate 1 or 2).
Alternate Speed Profile 1 Deactivated
Alternate Speed Profile 2 Activated. Alternate Speed Profile 2, ALT SPEED PROFILE 2. See Alternate Speed Profile 1 Activated.
Alternate Speed Profile 2 Deactivated
Ascending Car Overspeed Fault, ASCND CAR OVR SPD FLT
Description: Ascending Car Overspeed Fault. This fault is tripped if the elevator is traveling in the up direction, the Governor contact opens, and the Rope Gripper option is selected on the Safety Configuration screen. You will also see a Governor Open fault.
Car Reaction: Emergency stop: Motor contactor and brake contactor immediately dropped. The rope brake drops if installed. If you do not have a RG (Rope Gripper) or EB (Emergency Brake) board in your controller, this fault will not appear.
Troubleshooting: <ol style="list-style-type: none"> 1. Check the iView event log for related events. 2. Identify and correct any operational problems. Check for proper governor operation. 3. Resetting the Governor switch will automatically clear this fault.
Attendant Service, Attendant Svc
Description: Indicates that the elevator is operating under Attendant Service mode of operation. Generally initiated via an input (switch or button) at the car operating panel.
Car Reaction: Car operates under attendant mode.
Troubleshooting: <ol style="list-style-type: none"> 1. Related input: Attendant service as indicated on the job prints.
Automatic Stop
Description: The Automatic Stop feature has been enabled.
Car Reaction: The car will stop at a user-defined floor whenever it passes that floor in a user-defined direction and the doors will open and remain open for a user-defined time.
Troubleshooting: <ol style="list-style-type: none"> 1. Check the parameters on the Configuration > Car Operation > Auto Stop tab for proper configuration. 2. 3.

Table 6.3 iControl Messages

iControl Messages
Backup Power Direction Reversal
Description: The <i>Backup power recall reverse direction</i> input has been activated (signal from the TAPS Traction Auxiliary Power Supply).
Car Reaction: The car direction of travel is reversed unless the car is on Earthquake operation and the <i>CW1/CW2 inputs</i> (Counterweight movement sensor) are active and reversal would move the car in the direction towards the counter weight.
Backup Power Recall OFF
Description: The <i>Backup power recall</i> input has been deactivated.
Backup Power Recall ON, BACKUP POWER RECALL
Description: The <i>Backup power recall</i> input has been activated (signal from the TAPS Traction Auxiliary Power Supply).
Car Reaction: If the car is not currently at a floor, it will move to a floor and cycle the doors. If no load weigher is used, the car will move to the closest floor. If a load weigher is used, direction is dependent on the car load and the Counterweight percentage parameter. If load weight is greater than Counterweight percentage, car moves down and vice versa.
Backup Power Unit Failure Activated, Backup power unit failure, BACKUP POWER FAILURE
Description: The <i>Backup power unit failure</i> input is low.
Car Reaction: None. The event is displayed and logged.
Troubleshooting:
<ol style="list-style-type: none"> 1. Check the UPS unit for faults. 2. Check the connection to the <i>Backup power unit failure</i> input. 3. It may be necessary to replace the battery
Backup Power Unit Failure Deactivated
Description: The <i>Backup power unit failure</i> input has changed back to its normally high state.
Balanced Mode
Description: Passenger operation. Up and Down traffic treated equally. Assigned by group controller.
Battery Voltage Low-IMP, BATTERY VLTG LOW-IMP
Description: The voltage on Battery B1 on the IMP board has dropped below 2.22 VDC and the battery must be replaced. Otherwise the BBRAM will be unable to retain the data stored during a power loss or shut down.
Blocking New Remote Connections, BLOCKING REMOTE UIS
Description: When a car switches from Local to Local Dispatcher, many parameters and connections to other cars must be stabilized. During this time the new Local Dispatcher will not accept any new remote connections for 30 seconds.
Car Reaction: iView will remain connected if it was already connected. Any new iMonitor, iReport, Liftnet, BMS, etc. connections will be denied for 30 seconds while the car is syncing up and stabilizing data.
Troubleshooting:
<ol style="list-style-type: none"> 1. If this message is persistent for more than 30 seconds or if it seems to come and go for extended periods of time, the car may be confused as to if it should be the Local Dispatcher. Check the Alternate Dispatcher settings (System Configuration > Building tab), and Car ID (Controller > General > General tab) parameters. This has been an issue when upgrading a car designated as Alternate Dispatcher with a Car ID not = 1. A reboot was necessary to fix it, but is also necessary after an upgrade anyway.
Brake Contactor Driver Proofing Fault, BRAKE CNT DRV PRF FLT
Description: Fault signal for brake contactor driver proofing.
Car Reaction: None
Troubleshooting:
<ol style="list-style-type: none"> 1. Verify brake contactor driver proofing circuits.

Table 6.3 iControl Messages

iControl Messages
Brake Contactor Proofing Fault, BRAKE CONT PRF FAULT
Description: Fault signal for brake contactor proofing.
Car Reaction: None
Troubleshooting: 1. Verify brake contactor proofing circuits.
Brake Drop Fault, BRAKE DROP FAULT
Description: Indicates that the brake contact input (SP2D or Brake Switch) was not in the state required by the "Brake is picked when SP2D or Brake Switch terminal is high (low)" parameter, indicating that the brake was not fully dropped for more than one second after the car has stopped. This fault may be bypassed on the Controller > Diagnostics > Fault Bypass tab by setting Brake Switch.
Car Reaction: Car is removed from service.
Troubleshooting: 1. On the Controller > Configuration > Brake > Control tab, check "Brake is picked when SP2D or Brake Switch terminal is high (low)" to determine the proper state of terminal SP2D or Brake Switch when the brake is dropped (see "Configuration - Brake Tab" on page 9-24). 2. Verify proper operation of the brake and brake switch (open or closed, see step 1) when the brake is fully dropped. 3. With the brake dropped, verify the state of input SP2D or Brake Switch (low or high, see step 1). Please refer to "Installing Brake Monitoring" on page 3-20. 4. Use the iBox Fault Reset button to reset the fault.
Brake Enable Fault
Description: When the brake module is enabled, a feedback signal is generated for the iBox. If the feedback signal is not detected, this fault is generated.
Car Reaction: Emergency stop: Motor and brake contactors immediately dropped.
Troubleshooting: 1. Check the Brake Voltage Feedback test point on the iView Oscilloscope screen. 2. Check the iField Brake Module connections. 3. Check the brake and brake connections. 4. If brake feedback voltage is actually present, the iBox Safety board may be defective.
Brake Module Over Temperature Fault, BRAKE OVER TEMP FAULT
Description: Temperature sensor in the brake module detected an overheat condition.
Car Reaction: If the car is running, it will continue to answer current call. After the car is stopped at a floor, the car will not be allowed to run until the overheat condition clears.
Troubleshooting: 1. Check for excessive machine room ambient temperature. (Should not exceed 104 degrees F or 40C.) 2. Verify that air enters through the bottom of the power box and is only expelled via the fan at the top of the power box. 3. Check the running temperature inside the power box (should not exceed 105 degrees F). 4. Check for insufficient air circulation through the power box. 5. Check for improperly picking brake. 6. Check for faulty brake module. 7. Check for faulty connection between brake module and iBox.

Table 6.3 iControl Messages

iControl Messages
Brake Output Circuit Failure, BRAKE OUTPUT FAILURE
Description: The flywheel brake IGBT has failed or the fuse has opened.
Car Reaction: Normal stop.
Troubleshooting: <ol style="list-style-type: none"> Verify proper operation of the brake module while running on machine room inspection: <ul style="list-style-type: none"> Does the brake pick voltage match the setting on the Configuration > Brake tab? Does the brake hold voltage match the setting on the Configuration > Brake tab? Verify proper operation of the brake module while performing the Brake Calibration: <ul style="list-style-type: none"> Does the voltage max out and then slowly ramp down to about 10% of maximum supply voltage? Does the current max out and then slowly ramp down to about 10% of maximum supply current? If the brake module is constantly outputting maximum voltage and current based on the testing in steps 1 and 2, the main IGBT on the module is most likely damaged. The module must be replaced. CAUTION: An open or damaged RB resistor can cause the IGBT to fail. Check the resistor by removing the center tap and measuring the value of the entire resistor. It is strongly recommended to do this before installing another brake module.
Brake Pick Fault, BRAKE PICK FAULT
Description: Indicates that the brake contact input (SP2D or Brake Switch) was not in the state required by the "Brake is picked when SP2D or Brake Switch terminal is high (low)" parameter, indicating that the brake was not fully picked during one entire run or was late going low (or high) indicating a slow picking brake during three consecutive runs. This fault may be bypassed on the Controller > Diagnostics > Fault Bypass tab by setting Brake Switch.
Car Reaction: Car completes it's nearest run and is removed from service.
Troubleshooting: <ol style="list-style-type: none"> On the Controller > Configuration > Brake > Control tab, check "Brake is picked when SP2D or Brake Switch terminal is high (low)" to determine the proper state of terminal SP2D or Brake Switch when the brake is picked (see "Configuration - Brake Tab" on page 9-24). Verify proper operation of the brake and brake pick switch (open or closed, see step 1) when the brake is fully picked. With the brake picked, verify the state of input SP2D or Brake Switch (low or high, see step 1). Please refer to "Installing Brake Monitoring" on page 3-20. Use the iBox Fault Reset button to reset the fault.
Brake Pick Fault Off (See: Brake Pick Fault)
Brake Voltage Not On Fault, BRAKE V NOT ON FAULT
Description: After brake contactors are picked and controller did not receive more than 30% of the picking voltage after 1 second, this fault is generated. May be bypassed on the Diagnostics > Fault Bypass tab.
Car Reaction: Emergency stop: Motor contactor and brake contactor immediately dropped. Fault will self clear and car will attempt to run again.
Troubleshooting: <ol style="list-style-type: none"> Verify Brake AC input voltage at FB1 and FB2. Verify FB1 and FB2 fuses are good. Verify J2 connector on right side of iBox is seated properly. Verify brake output voltage with multimeter on terminals B1 and B2. Recalibrate brake module if applicable.
Bus 2 Fuse Open, BUS 2 FUSE OPEN
Description: The bus 2 fuse is open.
Car Reaction: Emergency stop. Cancel demand and open doors. No further movement is allowed.
Troubleshooting: Check bus 2 fuse located at bottom of iBox.
Bus 2D Fuse Open, BUS 2D FUSE OPEN
Description: The bus 2D fuse is open.
Car Reaction: Emergency stop. Cancel demand and open doors. No further movement is allowed.

Table 6.3 iControl Messages

iControl Messages
Troubleshooting: Check bus 2D fuse located at bottom of iBox.
Bus 2MC Fuse Open, BUS 2MC FUSE OPEN
Description: The bus 2MC fuse is open.
Car Reaction: Emergency stop. Cancel demand and open doors. No further movement is allowed.
Troubleshooting: Check bus 2MC fuse located at bottom of iBox.
Bus 2PI Fuse Open, BUS 2PI FUSE OPEN
Description: The bus 2PI fuse is open.
Car Reaction: None. The PI signals will not be active.
Troubleshooting: Check bus 2PI fuse located at bottom of iBox.
Bus 3 Fuse Open, BUS 3 FUSE OPEN
Description: The bus 3 fuse is open.
Car Reaction: Emergency stop. Cancel demand and open doors. No further movement is allowed.
Troubleshooting: Check bus 3 fuse located at bottom of iBox.
Bus 3HA Fuse Open, BUS 3HA FUSE OPEN
Description: The bus 3HA fuse is open.
Car Reaction: None. No further movement is allowed when on Access operation.
Troubleshooting: Check bus 3HA fuse located at bottom of iBox.
Capture Input OFF (see Capture Input ON)
Capture Input ON
Description: Discrete input used to capture the car. This input will activate Capture mode, similar to the iBox Capture switch (see also: Capture Mode).
Car Reaction: The car takes itself out of hall call service. Hall calls are canceled if no other car is available for hall call service. The car is also not eligible for parking.
Troubleshooting: Check the related discrete inputs.
Capture Mode, Capture
Description: Indicates the Capture mode switch on the iBox has been placed in the ON position.
Car Reaction: Car enters capture mode, removing itself from group operation (hall calls assigned to it will be reassigned to another elevator if possible). The car answers registered car calls but does not respond to hall call demand. Intended to allow maintenance personnel access to the car.
Car delayed with doors closed, CAR DEL DOORS CLOSED
Description: Indicates that a car, with doors fully closed, has been delayed in reaching an assigned destination.
Car Reaction: Assigned hall calls will be reassigned to other available cars.
Troubleshooting:
1. Determine what is inhibiting the car from reaching its destination.
2. Check the event log for any faults that may have prevented the car from moving.
Car delayed with doors closing, CAR DEL DOORS CLOSING
Description: Indicates that a car, with doors closing, has been delayed in reaching an assigned destination.
Car Reaction: Assigned hall calls will be reassigned to other available cars.
Troubleshooting:
1. Determine what is inhibiting the car from reaching its destination.
2. Check the event log for any faults that may have prevented the car from moving.

Table 6.3 iControl Messages

iControl Messages
Car delayed with doors open, CAR DEL DOORS OPEN
Description: Indicates that a car, with doors fully open, has been delayed in reaching an assigned destination.
Car Reaction: Assigned hall calls will be reassigned to other available cars.
Troubleshooting:
<ol style="list-style-type: none"> 1. Determine what is keeping the doors open or inhibiting them from closing. 2. Check the event log for any faults that may have prevented the doors from closing.
Car delayed with doors opening, CAR DEL DOORS OPENING
Description: Indicates that a car, with doors opening, has been delayed in reaching an assigned destination.
Car Reaction: Assigned hall calls will be reassigned to other available cars.
Troubleshooting:
<ol style="list-style-type: none"> 1. Determine what is inhibiting the doors from opening. 2. Check the event log for any faults that may have prevented the doors from opening.
Car delayed with doors stalled, CAR DEL DOORS STALLED
Description: Indicates that a car, with doors stalled, has been delayed in reaching an assigned destination.
Car Reaction: Assigned hall calls will be reassigned to other available cars.
Troubleshooting:
<ol style="list-style-type: none"> 1. Determine what is inhibiting the doors from closing. 2. Check the event log for any faults that may have prevented the doors from closing.
Car delayed with unknown door position, CAR DEL DOORS UNKNOWN
Description: Indicates that a car, with unknown door position, has been delayed in reaching an assigned destination.
Car Reaction: Assigned hall calls will be reassigned to other available cars.
Troubleshooting:
<ol style="list-style-type: none"> 1. Determine what is causing the doors to be reported in an invalid condition.
Car Dispatch Load. Not currently used.
Car Door Bypass, CAR DOOR BYPASS
Description: The Car Door Bypass switch on the iBox is in the Bypass position. (View-only on iView Safety screen, enabled/disabled by MCE according to safety jurisdiction.)
Car Reaction: The car is placed in Inspection mode. To move the car, you must place it in either cartop or car panel inspection mode. No other modes of operation are allowed.
Car Heavy Load Activated - Hall Calls Bypassed, CAR HEAVY LOAD
Description: The load in the car has exceeded the Heavy Load Threshold setting.
Car Reaction: Hall calls are bypassed until the heavy load condition is cleared. Hall calls assigned to this car are reassigned to other cars if possible.
Troubleshooting: (If displayed in error)
<ol style="list-style-type: none"> 1. Verify the programmed "Heavy Load Threshold" value and adjust if needed (Load Weigher Configuration screen). 2. Evaluate whether or not the load in the car exceeds the Heavy Load Threshold. Calibrate the load weigher if needed. 3. For discrete input load weighers, check the Heavy Load Input shown on the job prints.
Car Heavy Load - Deactivated

Table 6.3 iControl Messages

iControl Messages
Car out of service with doors closed, CAR OS DOORS CLOSED
Description: A delayed car with closed doors has remained so for an excessive period of time (as determined by a user-programmed timer parameter, Car Operation Screen/Passenger tab).
Car Reaction: The car removes itself from car and hall call service (car calls are canceled and hall calls are canceled or reassigned).
Troubleshooting: 1. Determine what is inhibiting the car from reaching its destination. 2. Check the event log for any faults that may have prevented the car from moving.
Car out of service with doors closing, CAR OS DOORS CLOSING
Description: A delayed car with closing doors has remained so for an excessive period of time (as determined by a user-programmed timer parameter, Car Operation Screen/Passenger tab).
Car Reaction: The car removes itself from car and hall call service (car calls are canceled and hall calls are canceled or reassigned).
Troubleshooting: 1. Determine what is inhibiting the car from reaching its destination. 2. Check the event log for any faults that may have prevented the car from moving.
Car out of service with unknown door position, CAR OS DOORS UNKNOWN
Description: A delayed car with invalid doors has remained so for an excessive period of time (as determined by a user-programmed timer parameter, Car Operation Screen/Passenger tab).
Car Reaction: The car removes itself from car and hall call service (car calls are canceled and hall calls are canceled or reassigned).
Troubleshooting: 1. Determine what is inhibiting the car from reaching its destination. 2. Check the event log for any faults that may have prevented the car from moving.
Car out of service with doors open, CAR OS DOORS OPEN
Description: A delayed car with open doors has remained so for an excessive period of time (as determined by a user-programmed timer parameter, Car Operation Screen/Passenger tab).
Car Reaction: The car removes itself from car and hall call service (car calls are canceled and hall calls are canceled or reassigned).
Troubleshooting: 1. Determine what is inhibiting the car from reaching its destination. 2. Check the event log for any faults that may have prevented the car from moving.
Car out of service with doors opening, CAR OS DOORS OPENING
Description: A delayed car with opening doors has remained so for an excessive period of time (as determined by a user-programmed timer parameter, Car Operation Screen/Passenger tab).
Car Reaction: The car removes itself from car and hall call service (car calls are canceled and hall calls are canceled or reassigned).
Troubleshooting: 1. Determine what is inhibiting the car from reaching its destination. 2. Check the event log for any faults that may have prevented the car from moving.
Car out of service with doors stalled, CAR OS DOORS STALLED
Description: A delayed car with stalled doors has remained so for an excessive period of time (as determined by a user-programmed timer parameter, Car Operation Screen/Passenger tab).
Car Reaction: The car removes itself from car and hall call service (car calls are canceled and hall calls are canceled or reassigned).
Troubleshooting: 1. Determine what is inhibiting the car from reaching its destination. 2. Check the event log for any faults that may have prevented the car from moving.

Table 6.3 iControl Messages

iControl Messages
Car Over Load Activated, CAR OVERLOAD
Description: The load in the car has exceeded the Overload Threshold setting.
Car Reaction: The car is held at the floor with doors open. Over load indicators, if present, will be activated.
Troubleshooting: <ol style="list-style-type: none"> 1. If this message appears to be displayed in error, verify the programmed Over Load Threshold value and adjust if needed. Please refer to "Configuration - Loadweigher" on page 9-126. 2. Evaluate whether or not the load in the car exceeds the Over Load Threshold value. Calibrate the load weigher if necessary. 3. For discrete input load weighers, check the Over Load input shown on the job prints.
Car Over Load Deactivated
Car Panel Inspection Disabled, CP INSP. DISABLED
Description: Car Panel inspection operation has been disabled.
Car Reaction: The car cannot be run on car panel inspection operation.
Troubleshooting: <ol style="list-style-type: none"> 1. Check for any car status that might prevent car panel inspection operation, e.g. earthquake. 2. Check for the Stuck Inspection Input Fault. 3. Check all inspection buttons (Enable, Up, Down) and verify that none are stuck in the ON position.
Car Panel Inspection Enabled
Description: Car Panel inspection operation which was previously disabled is now enabled.
Car Panel Inspection Inputs OK
Description: One or more previously stuck cartop inspection inputs (Enable, Up, Down) have been deactivated (see Stuck Car Panel Inspection Input message).
Car Panel Inspection Operation, Car Panel Inspection, Car Panel Insp.
Description: The car has been placed in inspection mode using a (typically) keyed switch on the car operation panel.
Car Reaction: If running, the car makes an emergency stop and is taken out of passenger service. The car uses the inspection pattern settings and can only be moved using the car panel inspection key switches.
Troubleshooting: <ol style="list-style-type: none"> 1. Check the car panel inspection switch and related inputs. 2. The Car Panel Inspection input is Normally High.
Car shut down due to emergency power operation with no supervisor (Activated)
Description: iControl has detected that an emergency power condition exists and it has not established communication with the emergency power supervisor (typically a group controller).
Car Reaction: The car is not allowed to move to prevent overloading the emergency power generator. If the car is moving when the event occurs, the car will make an emergency stop. motor contactor and brake contactor are immediately dropped. The car is also shut down (calls and all other demands are canceled).
Troubleshooting: <ol style="list-style-type: none"> 1. If this condition exists and the system is NOT operating under emergency power, refer to the job prints and verify wiring to the controller Emergency Power status input. 2. Verify correct input state (high/low) on iView/Car Operation/Emergency Power/EPI Input setting. 3. Check group to car communication.
Car shut down due to emergency power operation with no supervisor (Deactivated)
Description: Emergency power condition, without established communication with group supervisor, has been resolved. Either communication with the supervisor has been established or the emergency power condition has been removed.
Car Reaction: While emergency power is in effect, the car is allowed to move as determined by the group controller (iCue). Car selection for recall and emergency power operation is user -determined (iView/Car Operation/Emergency Power and iCue iView/Emergency Power Configuration screens).

Table 6.3 iControl Messages

iControl Messages
Car Stop Switch Open, CAR STOP SWITCH OPEN
Description: The car panel stop switch input has dropped (in-car stop switch has been activated). This switch may be bypassed during special modes of operation such as fire, CFSS, or EMS.
Car Reaction: Emergency stop if running. The car is not allowed to run again until the car panel stop switch is moved to the RUN position.
Troubleshooting: <ol style="list-style-type: none"> 1. Check the in-car stop switch and switch connections. 2. Check current mode of operation and verify that the stop switch operation is as expected.
Cartop Automatic Unintended Motion Fault, CARTOP AUTO UIM FLT
Description: An unintended motion fault has been detected while the car was running under Passenger operation.
Car Reaction: Emergency Stop. Cancel all calls. This fault will self reset.
Troubleshooting: <ol style="list-style-type: none"> 1. Check the iView Event Log for preceding activity. 2. Correct initiating problem, if any.
Cartop Communication Established
Description: Communication between iControl (iBox) and the iLink ICE-CTP board has been established. This communication is through twisted-pair, shielded cabling in the traveler cable.
Cartop Communication Fault, CARTOP COMM FAULT
Description: Communication between iControl and iLink have failed. This communication is through twisted-pair, shielded cabling in the traveler cable.
Car Reaction: Emergency Stop. Cancel all calls.
Troubleshooting: <ol style="list-style-type: none"> 1. Check the connections at the iBox and iLink ends of the connection. Refer to -CW job print drawing. 2. If the connections are clean and tight, use an oscilloscope to check the TX and RX signals themselves. Or, if practical, connect the iBox end of the connection to another iControl in the machine room and see if that controller can communicate with the iLink box. 3. If required, replace the iLink Cartop board or the iBox as appropriate.
Cartop Emergency Stop
Description: The cartop processor has detected a fault and initiated an emergency stop. The Cartop Safety relay has opened in response to an unsafe condition.
Car Reaction: Emergency stop: Motor contactor and brake contactor immediately dropped. Cancel all calls.
Troubleshooting: <ol style="list-style-type: none"> 1. Check the iView Event Log for related preceding events. 2. Troubleshoot and correct any initiating problem. 3. Restore safety string and test.
Cartop Exit Open, CARTOP EXIT OPEN
Description: The Cartop Exit Switch input has dropped. The input is normally on when the configuration states that the switch is installed. The input may be bypassed by: 1) the car being on car top or car panel inspection while on earthquake, and 2) the safety bypass jumper being installed.
Car Reaction: Emergency stop if running. The car is not allowed to run until the problem is corrected.
Troubleshooting: <ol style="list-style-type: none"> 1. Check the switch status and configuration (Safety screen). 2. Check elements related to bypassing.
Cartop Exit Open Off (see: Cartop Exit Open)

Table 6.3 iControl Messages

iControl Messages
Cartop Exit no Counterweight Configuration Error, CTEX NO CWI CFG ERROR
Description: Car Top Exit, on the Safety tab, has been checked but Counter weight displacement detection, on the Car Operation - Earthquake tab, has not been checked. A car equipped with both Earthquake Operation and Cartop Exit must have a counterweight derailment device.
Car Reaction: The car is not allowed to run until the problem is corrected.
Troubleshooting: <ol style="list-style-type: none"> 1. Verify the status of the Car Top Exit parameter (Safety tab). 2. Verify the status of the Counter weight displacement detection parameter (Car Operation - Earthquake tab).
Cartop Firmware Update Mode, CARTOP FW UPDATE MODE
Description: The cartop processor is not running the cartop application firmware but is instead either waiting for or processing the firmware update (iView > File > Firmware update).
Car Reaction: The car is not allowed to run until the procedure is completed.
Cartop Inspection Disabled, CT INSP. DISABLED
Description: Cartop inspection operation has been disabled.
Car Reaction: The car cannot be run on cartop inspection operation.
Troubleshooting: <ol style="list-style-type: none"> 1. Check for any car status that might prevent cartop inspection operation, e.g. earthquake. 2. Check for the Stuck Inspection Input Fault. 3. Check all inspection buttons (Enable, Up, Down) and verify that none are stuck in the ON position.
Cartop Inspection Enabled
Description: Cartop inspection operation which was previously disabled is now enabled.
Cartop Inspection Inputs OK
Description: One or more previously stuck cartop inspection inputs (Enable, Up, Down) have been deactivated (see Stuck Cartop Inspection Input message).
Cartop Inspection Operation, Cartop Inspection, Cartop Insp
Description: The car has been placed in Inspection mode using the cartop inspection switch.
Car Reaction: The car enters inspection mode and uses the Inspection pattern settings.
Cartop Inspection Unintended Motion Fault, CARTOP INSP UIM FLT
Description: An unintended motion fault was detected while the car was being operated on Cartop Inspection Operation.
Car Reaction: Car motion stopped after 24 inches of travel. The safety circuit is opened.
Troubleshooting: <ol style="list-style-type: none"> 1. Check the iView Event Log for related events. 2. Troubleshoot and correct any initiating problems. 3. Press iBox Fault Reset. 4. Test.
Cartop Power Loss
Description: A loss of power was detected by the iLink processor.
Car Reaction: Emergency stop: Motor contactor and brake contactor immediately dropped.
Troubleshooting: <ol style="list-style-type: none"> 1. Check 1, 2, and 3 bus terminal voltages from iControl, through traveler, to car terminal strip. 2. Refer to job print drawing CT, check strip to iLink connections. 3. Check iLink fuses F1 and FCT1.
CFSS Mode 1 at Floor Activated, CFSS 1 at Floor. See CFSS Mode 1 In-car Activated.

Table 6.3 iControl Messages

iControl Messages
CFSS Mode 1 In-car Activated, CFSS 1 In-car.
Description: Commandeer For Special Services is a special operating mode. When activated by a (typically) keyed hall switch the car recalls to that floor. Two CFSS operating modes may be configured on the Car Operations screen/CFSS tab (Mode 1, Mode 2). Typically, one of the two is used for Hospital Operation, the second as the user determines. Once recall is activated, the car disposes of existing calls as configured on the CFSS tab, then moves to the recall floor. At the recall floor, In-Car CFSS is activated by an in-car switch or as configured on the CFSS tab (In-Car).
Car Reaction: As configured on the Car Operations screen/CFSS tab.
CFSS Mode 1 Recall Activated, CFSS 1 Recall. See CFSS Mode 1 In-car Activated.
CFSS Mode 2 at Floor Activated, CFSS 2 at Floor. See CFSS Mode 1 In-car Activated.
CFSS Mode 2 In-car Activated, CFSS 2 In-car. See CFSS Mode 1 In-car Activated.
CFSS Mode 2 Recall Activated, CFSS 2 Recall. See CFSS Mode 1 In-car Activated.
Construction Car Panel Inspection Operation, Cnstr Car Panel Insp, Cnstr CP Insp
Description: The car is on Construction mode and car panel inspection.
Car Reaction: Car is out of service and cannot be moved using the car panel inspection key switches.
Troubleshooting: When Construction mode is active, car panel operation switches are ignored. The car can only be moved using Machine Room or Cartop Inspection switches. Place the car on Machine Room or Cartop Inspection and use the appropriate switches to move the car.
Construction Cartop Inspection Operation, Cnstr Cartop Insp, Cnstr CT Insp
Description: Car is on Construction mode and Cartop Inspection. When the iBox is in construction mode, it is always “on inspection.” It will only operate in Cartop or Machine Room inspection. Car top has precedence over Machine Room, just as in Passenger operation. If neither of these two modes of operation are selected, the controller goes into a non-specific inspection mode. It will not run for any inspection direction input.
Car Reaction: The car can be moved using the cartop inspection key switches.
Troubleshooting: 1. If it appears that the car is on Cartop Inspection operation in error, verify wiring to the iBox INCT input. If no voltage exists on this input, the car will operate under Cartop Inspection operation.
Construction Hoistway Access Inspection Operation, Cnstr HA Inspection, Cnstr HA Insp
Description: Car is on construction mode and hoistway access.
Car Reaction: Car is out of service and cannot be moved using the hoistway access Up or Down switches.
Troubleshooting: When Construction mode is active, hoistway access switches are ignored. The car can only be moved using Machine Room or Cartop Inspection switches. Place the car on Machine Room or Cartop Inspection and use the appropriate switches to move the car.
Construction Inspection Operation, Cnstr Inspection
Description: The car is operating in Inspection mode and the Construction setting on the Safety Configuration screen is selected.
Car Reaction: The car will operate using the Inspection performance pattern using Cartop or machine room inspection modes only.
Construction Machine Room Inspection Operation, Cnstr Mach Room Insp, Cnstr MR Insp
Description: Car is on inspection mode using the iBox inspection switch while on construction mode.
Car Reaction: Car begins operating in Inspection mode. If running, the car will make an emergency stop and is taken out of normal service. Under this mode of operation, the car can be moved using the iBox Inspection Up and Down switches.
Troubleshooting: 1. Related inputs: MachineRoomInspection: Normally high
Controller Main Computer Startup
Description: iBox main processor booting up.

Table 6.3 iControl Messages

iControl Messages
Demand Down Peak Mode, DEMAND DOWN PEAK MODE
Description: The car is running in Demand Down Peak mode, favoring traffic in the down direction as configured on the group control screens.
Demand Up Peak Mode, DEMAND UP PEAK MODE
Description: The car is running in Demand Up Peak mode, favoring traffic in the up direction as configured on the group control screens.
Dispatcher = Car 'n', DISPATCHER = CAR'n' (n = 1 to 20)
Description: Communication with the main iCue dispatcher has been lost or not established. This car is communicating with Car 'n' (n = 1 to 20) which is acting as the backup dispatcher.
Troubleshooting: Check the group to car communication related connections and parameters.
Door Lock Clipped Greater than 200fpm, DOOR LK CLIPPED G200
Description: The door lock signal (DLAT, DLMS, DLAB, or GS) went low for over 300mS while the car was moving at over 200 fpm.
Car Reaction: Emergency stop: Motor contactor and brake contactor immediately dropped.
Troubleshooting:
<ol style="list-style-type: none"> 1. Use the Event Log to determine where the fault occurred. Examine the locks in that area of the hoistway first. 2. Usually caused by a misadjusted door, where the pickup rollers do not have adequate running clearance from the door clutch. 3. Because this fault must persist for over 300mS, a slight "bumping" of the door lock will not set it off. If the door clutch/pickup roller clearance is adequate, make sure the door contacts are clean and the door lock mechanism drops cleanly without friction or binding.
Door Lock Clipped Less than 200fpm, DOOR LK CLIPPED L200
Description: The door lock signal (DLAT, DLMS, DLAB, or GS) went low while the car was moving at under 200 fpm.
Car Reaction: ASAP stop.
Troubleshooting:
<ol style="list-style-type: none"> 1. Usually caused by a misadjusted or damaged door. Because it only occurs at speeds under 200 fpm, it is usually seen when the car leaves the floor where the problem door is located.
DOOR LOCK OPENED
Description: This is a status message indicating that the safety processor has detected that the door lock is open. A fault is generated if the car is moving or attempts to move while the door lock is open.
Down Direction Limit Open, DOWN DIR LIMIT OPEN
Description: Down normal terminal direction limit switch is open.
Car Reaction: Initiate an immediate stop if moving. Further down direction movement is prevented.
Troubleshooting:
<ol style="list-style-type: none"> 1. Verify that the switch is operating properly. 2. Verify correct state of the iBox DNTD input. 3. Verify that DNTD switch is activating/deactivating at the appropriate location (normally 2" below the bottom terminal landing - see prints).

Table 6.3 iControl Messages

iControl Messages
Down Emergency Terminal Switch Position Fault, DN ETS POSITION FAULT
Description: The reported position upon encountering the Terminal Switch differed from the learned switch position by more than the set position margin. This fault may be bypassed on the Diagnostics > Fault Bypass tab.
Car Reaction: Emergency Stop: Motor contactor and brake contactor immediately dropped. All hall and car calls are cancelled. After the car is stopped, it will run at Correction speed to the next available floor and cycle the door. Door Open button will remain operational. If fault generated when car is moving, fault will stay latched and the Fault Reset button must be pushed to clear it. If generated when the car is not moving, fault will self clear when condition no longer exists.
Troubleshooting: <ol style="list-style-type: none"> 1. Physically check the integrity of the switch and wiring. 2. Check the iBox input for the switch. 3. On the Diagnostics > Terminal Switches Status tab, compare the last pass position against the learned position for this switch. Verify that Position Margin is within a reasonable range. Relearn the NTS and ETS switches. Please refer to "Learning Normal & Emergency Terminal Limit Switches" on page 4-9.
Down Emergency Terminal Switch Shutdown, DOWN ETS SHUTDOWN
Description: The Down Emergency Terminal switch opened at a speed or position exceeding its specified threshold. The fault stays latched and the Fault Reset button must be pushed to clear it. If generated when the car is stopped, the fault will self clear when the condition no longer exists.
Car Reaction: Emergency stop: Motor contactor and brake contactor immediately dropped.
Troubleshooting: <ol style="list-style-type: none"> 1. This fault is logged in conjunction with either a speed or position fault at DETS. Check the Event Log and follow the troubleshooting recommended for the Down Emergency Terminal Switch Position Fault or Safety A (or B) DETS Level 2 Speed Fault. 2. Press iBox Fault Reset to reset the fault.
Down Normal Terminal 'n' Level 1 Speed Fault, DN NTS'n' L1 SPEED FLT (n = 1 to 5)
Description: A Level 1 Overspeed fault has been detected at Down Normal Terminal switch 'n' (1 to 5). When the switch opened, the car was traveling faster than defined by level 1 overspeed settings (sum of learned speed plus Overspeed 1 Margin percentage on Configuration > Terminal Switches tab) but not fast enough to trigger the Level 2 overspeed fault. This fault may be bypassed on the Diagnostics > Fault Bypass tab.
Car Reaction: Controlled stop using Emergency Slowdown pattern parameters.
Troubleshooting: <ol style="list-style-type: none"> 1. On the Diagnostics > Terminal Switches Status tab, compare the last pass and the Learned speeds for this switch. If appropriate, increase the Overspeed 1 Margin on the Configuration > Terminal Switches tab. 2. May be caused by a change in the Pattern parameters. Always re-learn the terminal switches after any changes to Pattern parameters. 3. One or two floor runs can sometimes come in "hotter" than multi-floor runs. (Remember that the switches are learned making full hatch runs.) If short runs are causing this, you may have to increase the Overspeed 1 Margin or lower the Standard profile - High Roll Jerk parameter. 4. Can also be caused by a car that is following the pattern poorly, possibly due to heavy load or poor speed loop performance. In this case, adjust the speed loop to follow pattern as well as possible and/or alter the pattern parameters to produce a gentler deceleration and approach to the floor (then re-learn the switches). Please refer to "Terminal Switch Overspeed and Position Faults" on page 4-55.

Table 6.3 iControl Messages

iControl Messages
Down Normal Terminal 'n' Level 2 Speed Fault, DN NTS'n' L2 SPEED FLT (n = 1 to 5)
Description: A Level 2 Overspeed fault has been detected at Down Normal Terminal switch 'n' (1 to 5). When the switch opened, the car was traveling faster than defined by Level 2 overspeed settings (105% of the sum of the learned speed plus the Overspeed 1 Margin percentage setting on the Configuration > Terminal Switches tab). This fault may be bypassed on the Diagnostics > Fault Bypass tab.
Car Reaction: Emergency stop: Motor contactor and brake contactor immediately dropped.
Troubleshooting: <ol style="list-style-type: none"> 1. On the Diagnostics > Terminal Switches Status tab, compare the Last pass and Learn speeds for this switch. If appropriate, increase the Overspeed 1 Margin on the Configuration > Terminal Switches tab. 2. May be caused by a change in the Pattern parameters. Always re-learn the terminal switches after any changes to Pattern parameters. 3. One or two floor runs can sometimes come in "hotter" than multi-floor runs. (Remember that the switches are learned making full hatch runs.) If short runs are causing this, you may have to increase the Overspeed 1 Margin or lower the Standard profile - High Roll Jerk parameter. 4. Can also be caused by a car that is following the pattern poorly, possibly due to heavy load or poor speed loop performance. In this case, adjust the speed loop to follow pattern as well as possible and/or alter the pattern parameters to produce a gentler deceleration and approach to the floor (then re-learn the switches). Please refer to "Terminal Switch Overspeed and Position Faults" on page 4-55.
Down Normal Terminal 'n' Position Fault, DN NTS'n' POSITION FLT (n = 1 to 5)
Description: When the switch opened or closed, the car's reported position was different from the learned position by an amount exceeding the margin set on the Configuration > Terminal Switches tab. This may mean that the switch opened early, late or not at all on approach to the terminal. It may also mean that the switch closed early, late, or not at all on departure from the terminal. Finally, the switch can go open while standing at a floor where its learned position is closed, or go closed at a floor where its learned position is open. This fault may be bypassed on the Diagnostics > Fault Bypass tab.
Car Reaction: If traveling down, the car executes an emergency slowdown, then continues at low speed until it encounters a floor. The car stops at the floor, opens its doors, and performs a floor sync operation. If the fault persists, the car goes out of service. If traveling up, the car continues normally to the first stop, opens its doors and performs a floor sync operation. If the fault persists, the car goes out of service. If stopped at a floor, the car opens its doors, does a floor sync, and, if the fault persists, takes itself out of service.
Troubleshooting: <ol style="list-style-type: none"> 1. On the Diagnostics > Terminal Switches Status tab, compare the Last pass position to the Learned position for this switch. 2. If the fault is mechanical (switch movement, magnet movement, or bad traveler cable), the fault will tend to repeat at the same position every time. 3. A stuck switch is easy to spot by running the car on inspection and observing the input LEDs on the iBox. 4. Perform a Terminal Sync operation (Terminal button on the Configuration > Pattern > Common tab).
Drive At-Speed Fault, DRIVE AT-SPEED FAULT
Description: Detected by the drive, this fault indicates that the motor speed is outside threshold limits defined by the drive parameter. (This fault is not monitored for the TORQMAX F5 drive).
Car Reaction: Emergency stop: Motor contactor and brake contactor immediately dropped.
Troubleshooting: <ol style="list-style-type: none"> 1. If the job has a TORQMAX F5 drive and this fault occurs, verify that wires AT and GND (from iBox J46) are connected to drive terminal X2A-26 (Common).
Drive Communication Fault, DRIVE COMM FAULT
Description: A fault is generated if a serial drive interface is selected (Controller > Configuration > Drive tab) and either the serial port cannot be opened or there is a communication problem with the drive.
Car Reaction: Emergency stop: Motor contactor and brake contactor immediately dropped.
Drive Communication Warning, DRIVE COMM WARNING
Description: Not currently used.

Table 6.3 iControl Messages

iControl Messages
Drive Enable Feedback Fault, DRIVE ENABLE FDBK FLT
Description: iControl failed to send the Drive Enable signal to the drive or the drive failed to respond to the Drive Enable signal. (applies to both AC and DC drives).
Car Reaction: Emergency stop: Motor contactor and brake contactor immediately dropped. Followed by normal run. Fault will self clear and car is able to run again.
Troubleshooting: <ol style="list-style-type: none"> 1. This fault may indicate a problem with the Gate Switch, or one of the door locks, opening up during the initial start of car motion. Verify that the inputs (GS, DLAT, DLAB, DLMS) remain high. 2. Verify that Safety Processors A and B are looping (iBox status LEDs). 3. Verify that there are no faults active on Safety Processors A and B that would prevent motion. 4. Check the iBox power supply. 5. Verify that all drive connections match wiring prints.
Drive Fault, DRIVE FAULT
Description: Detected by the drive, this fault indicates that the motor speed is outside threshold limits defined by the drive parameter. (TORQMAX drive only.)
Car Reaction: Emergency stop: Motor contactor and brake contactor immediately dropped.
Troubleshooting: <ol style="list-style-type: none"> 1. Verify encoder wiring and polarities. 2. Check F5 drive terminals X2A-29 (Drive Fault) to X2A-26 (Common). The value should be high during normal operation and low during a fault condition. 3. Verify that the brake is working correctly. 4. Verify drive gains, Proportional Gain (LF.31) and Integral Gain (LF.32). 5. Check drive parameters, Speed Following Error (LF.57), Speed Difference (LF.58), and Following Error Timer (LF.59). Refer to the TORQMAX manual.
Drive Inspection Overspeed Fault, DRIVE IOS FAULT
Description: Inspection Overspeed fault.
Car Reaction: Emergency stop.
Troubleshooting: <ol style="list-style-type: none"> 1. Check Inspection speed. 2. Check safety configuration. 3. Calibrate car speed with a hand-held tachometer.
Drive On Fault, DRIVE ON FAULT (was Drive Ready On Fault)
Description: The drive failed to activate the DRO signal when it was sent the command to run (TORQMAX drives only).
Car Reaction: Emergency stop: Motor contactor and brake contactor immediately dropped.
Troubleshooting: <ol style="list-style-type: none"> 1. Check for fault messages on the F5 drive display and refer to <i>Error Messages and Their Causes</i> in the TORQMAX manual for suggested solutions. 2. Check the state of the F5 drive inputs by displaying diagnostic parameter LF.82. Refer to the LF.82 input state table in the TORQMAX F5 drive manual. 3. Check for proper operation of the PM contactor main contacts. 4. Verify that the cable from the F5 drive to the PowerBox (46 pin D-sub) is properly seated. 5. Then verify that the cable that extends to the iBox (AC/DC Drive jack) is properly seated. If the cable inside the PowerBox is suspect, temporarily connect directly from the F5 drive into the iBox. 6. Verify that Brake Pick Delay is set correctly (0.3 or higher) to allow the motor to build up torque. 7. Verify that F5 drive parameter LF.70 = 0.3. 8. If the DRO fault is accompanied by a Tach Error Fault, this usually indicates improper adjustment of the TACH ADJ trimpot (see "Verify Pattern Command and Drive Speed Feedback" on page 2-56). 9. On iView, display the Controller > Diagnostics > Diagnostic Outputs > Drive screen and verify that the commands are being sent from the iBox to the TORQMAX drive.

Table 6.3 iControl Messages

iControl Messages
Drive Ready Fault, DRIVE READY FAULT
Description: AC drive ready signal is low. (TORQMAX drive only.)
Car Reaction: Emergency stop: Motor contactor and brake contactor immediately dropped.
Troubleshooting: 1. Check F5 drive terminal X2A-24 to X2A-26 (Common). X2A-24 should be low during normal operation and high during fault. 2. Check connection from AC drive to iPower Box and J46 connector on ICE-SAF board.
Drive Start Failure
Description: The drive control logic has not responded to a movement request from the motion control logic for more than ten seconds.
Car Reaction: The motion control logic will continue to request movement from the drive logic for up to ten seconds before declaring a Motion Start Failure fault.
Troubleshooting: Verify that no drive or motor faults exist.
Dual Channel QUAD Fault, DUAL CHANNEL QUAD FLT
Description: The Safety system did not detect movement of the car even though the iBox processor reported car movement, or the Safety system reported car movement while the processor did not.
Car Reaction: Emergency stop: Motor contactor and brake contactor immediately dropped.
Troubleshooting: 1. Press the Fault Reset button. 2. Check the wiring for the DP1 and DP2 encoder signals from the landing system to the iBox. 3. Check the motor encoder or tachometer (whichever is present). 4. Compare Pattern Command and Speed Feedback on the iView oscilloscope screen to make certain they track one another. 5. Check reported speed accuracy using a hand-held tachometer.
Earthquake board power supply OFF
Description: The controller has detected a failure of the earthquake board power supply.
Car Reaction: The car behaves as if the counterweight derailment detector has been triggered (car generally makes an emergency stop, and is removed from service at the next available landing).
Troubleshooting: 1. Check board connections. 2. Replace the EQ board.
Earthquake board power supply ON
Description: The earthquake board (ICE-EQ) power supply is operational.
Car Reaction: Car is no longer prevented from operating due to a loss of the earthquake board power supply.
Earthquake Emergency Stop
Description: Earthquake operation has been activated by the seismic or counterweight displacement switches and the car has performed an emergency stop as specified by the earthquake user settings.
Car Reaction: The car will perform an emergency stop. After a pause, the car will react as directed by user settings on the Car Operation screen Earthquake tab.
Troubleshooting: 1. Check the wiring for the seismic and counterweight displacement inputs. 2. Check the earthquake user settings on the Car Operation screen Earthquake tab.
Earthquake Operation Activated
Description: The car is on earthquake operation.
Car Reaction: Car behavior is according to the user settings on the Car Operation screen Earthquake tab. This operation is latched until the EQ reset button is pressed on the ICE-EQ board.
Troubleshooting: NA. See also "Earthquake Operation (Seismic Switch)" and "Earthquake Operation (Counterweight)".

Table 6.3 iControl Messages

iControl Messages
Earthquake Operation Deactivated
Earthquake Operation (Counterweight)
Description: The Counterweight Derailment Detector has been activated, indicating an earthquake condition.
Car Reaction: The car will typically make an emergency stop, then move slowly to the next available floor in a direction away from the counterweight. The fault is latched until the EQ reset button (ICE-EQ board) is pressed.
Troubleshooting: 1. If it is suspected that this event happened in error, check the counterweight derailment detector operation and associated wiring to the ICE-EQ board.
Earthquake Operation (Seismic Switch)
Description: The Seismic Switch has been activated (input has gone low), indicating an earthquake condition.
Car Reaction: The car will react as determined by user configuration. (iView/Car Operation/Earthquake) The car will either make an emergency stop and then move slowly to the next available floor or it will stop normally at the next available floor in the direction of travel. The fault is latched until the EQ reset button (ICE-EQ board) is pressed.
Troubleshooting: 1. If it is suspected that this event happened in error check the seismic switch input and the associated wiring to the ICE-EQ board. The seismic input is normally on.
Earthquake Reduce Speed
Description: An earthquake event (seismic switch) has initiated a car speed reduction (150 fpm or less) as required by some code jurisdictions.
Car Reaction: Control stop.
Earthquake reset button OK
Description: A previously declared failure of the earthquake reset button has been resolved.
Car Reaction: Previous failure is no longer a reason to keep the car out of service.
Earthquake reset button stuck ON
Description: The controller has detected that the earthquake reset button (located on the ICE-EQ board) has failed in the "on" state.
Car Reaction: If moving, the car will complete its run. Once stopped, the car is removed from service.
Troubleshooting: 1. It is likely that the reset button (or related circuitry) on the ICE-EQ board is faulty. 2. Replace the ICE-EQ board.
Earthquake Run, EARTHQUAKE RUN
Description: Some code jurisdictions allow the car to run normally (at a speed no greater than 150 fpm) under earthquake conditions. This event indicates that the car is being allowed to run in this manner.
Car Reaction: Car operates "normally" at reduced speed.
Troubleshooting: 1. Check the wiring for the seismic and counterweight displacement inputs. 2. Check the earthquake user settings on the Car Operation screen Earthquake tab.
Earthquake Shutdown, EARTHQUAKE SHUTDOWN . See Earthquake Operation Activated.
EEPROM Device Error, EEPROM DEVICE ERROR
Description: Safety Processor A EEPROM fault.
Car Reaction: Emergency stop: Motor contactor and brake contactor immediately dropped.
Troubleshooting: 1. Verify Safety Processor A EEPROM - board test. Contact MCE.

Table 6.3 iControl Messages

iControl Messages
Elevator Recall Operation (Switch 'n'), ELEVATOR RECALL SW'n' (n = 1 to 6)
Description: Elevator Recall Operation has been initiated by the switch identified.
Car Reaction: In most usages, the car immediately removes itself from hall call service, answers remaining car calls, then proceeds to the recall floor and cycles its doors. (The disposition of car calls, recall floor, and door operation are user-programmable. iView/Car Operation/Elevator Recall.)
Emergency Alarm Acknowledged
Description: This message indicates that the emergency alarm has been acknowledged and reset by the Emergency Alarm Reset input.
Car Reaction: The Distress Light and the Distress Buzzer outputs will be extinguished.
Troubleshooting: NA
Emergency Alarm Activated (Alarm button), Emergency Alarm Activated, EMERG ALARM ACTIVATED
Description: The Emergency Alarm input has been activated. Typically used to sound an alarm and/or illuminate an indicator light to alert security personnel.
Car Reaction: The Distress Light will be illuminated until it is acknowledged by the Emergency Alarm Reset input. The Distress Buzzer output will either pulsate or is continuously activated as long as the car remains in this condition.
Troubleshooting: <ol style="list-style-type: none"> Attend to the car and verify the distress signal. To reset the alarm, verify that the alarm button is restored to normal condition and activate the Emergency Alarm Reset input.
Emergency Alarm Activated (Car delayed with doors closed)
Description: This message indicates that the emergency alarm has been activated due to the car being delayed with its doors closed. This is an optional emergency alarm monitor specified by the user.
Car Reaction: The Distress Light will be illuminated until it is acknowledged by the Emergency Alarm Reset input. The Distress Buzzer output will be active as long as the car remains in this condition.
Troubleshooting: <ol style="list-style-type: none"> Attend to the car and verify the distress signal. To reset the alarm, verify that the car condition is restored to normal and activate the Emergency Alarm Reset input.
Emergency Alarm Activated (In-car stop switch)
Description: This message indicates that the emergency alarm has been activated due to the in-car emergency stop switch being pulled.
Car Reaction: The Distress Light will be illuminated until it is acknowledged by the Emergency Alarm Reset input. The Distress Buzzer output will be active as long as the switch remains active.
Troubleshooting: <ol style="list-style-type: none"> Attend to the car and verify the distress signal. To reset the alarm, verify that the car emergency stop switch is restored to normal position and activate the Emergency Alarm Reset input.
Emergency Alarm Activated (Safety opened)
Description: This message indicates that the emergency alarm has been activated due to the safety circuit being opened (excluding the in-car emergency stop switch). This is an optional emergency alarm monitor specified by the user.
Car Reaction: The Distress Light will be illuminated until it is acknowledged by the Emergency Alarm Reset input. The Distress Buzzer output will be active as long as the car remains in this condition.
Troubleshooting: <ol style="list-style-type: none"> Attend to the car and verify the distress signal. To reset the alarm, verify that the car condition is restored to normal and activate the Emergency Alarm Reset input.

Table 6.3 iControl Messages

iControl Messages
Emergency Alarm Deactivated without Acknowledgment
Description: This message indicates that the emergency alarm has been deactivated because all signals that would activate it are now off and the Require Acknowledgment parameter is not checked.
Car Reaction: The Distress Light and Distress Buzzer outputs are deactivated.
Emergency Brake Leg 1 Short Fault, EMERG BRK LEG 1 SHORT
Description: Emergency brake board (ICE RB or ICE EB) verification failed after a stop or as a result of a fault reset. During these scenarios, the emergency brake circuitry is verified by transitioning between leg 1 and leg 2. One of the legs must be active to prevent the emergency brake from deploying.
Car Reaction: Emergency stop.
Troubleshooting: <ol style="list-style-type: none"> 1. Verify system configured for emergency brake board (ICE-RG or ICE EB). 2. Make sure the emergency brake board is physically present and correctly connected.
Emergency Brake Leg 2 Short Fault, EMERG BRK LEG 2 SHORT. See Emergency Brake Leg 1 Short Fault.
Emergency Brake OK open, EMERG BRAKE OK OPEN
Description: The Emergency Brake OK input has dropped (off) when the configuration states that the brake is installed and therefore the input should be picked (on).
Car Reaction: Emergency stop if running. The car is not allowed to run until the problem is corrected.
Troubleshooting: <ol style="list-style-type: none"> 1. Verify that the Rope Gripper board is properly installed, connected, and powered. 2. If this job has a sheave brake, verify that the associated circuitry is per the job prints.
Emergency Brake OK open Off (See: Emergency Brake OK open)
Emergency Brake Tripped, EMERG BRAKE TRIPPED
Description: The emergency brake output (ICE RG or ICE-EB board) has gone low, causing the emergency brake to set.
Car Reaction: Emergency stop.
Troubleshooting: <ol style="list-style-type: none"> 1. Check that the output did not go low in error and is properly connected. 2. Check the elevator for underlying causes.
Emergency Brake UIM Reset Button Stuck, EM BK UIM RESET STUCK
Description: The reset button on the Rope Gripper board (ICE-RG) or Emergency Brake board (ICE-EB) has been activated for more than 15 seconds.
Car Reaction: The car is not allowed to move. If in motion, the car is allowed to finish the run.
Troubleshooting: Check the reset button on the ICE-RG or ICE-EB board.
Emergency Dispatch On, Emergency Dispatch, EMERGENCY DISPATCH
Description: The car is automatically servicing the building in a pre-defined pattern. This operation is invoked when a failure of the hall calls bus or group communication is detected. This operation may also be activated using a key switch input.
Car Reaction: The car automatically moves to every floor in the building in a predefined pattern and cycles its doors.
Troubleshooting: <ol style="list-style-type: none"> 1. Check group/car communications. 2. Check the hall call bus drivers. 3. Check the Emergency Dispatch input.
Emergency Dispatch Off (see Emergency Dispatch On)

Table 6.3 iControl Messages

iControl Messages
Emergency Medical Service Bypassed
Description: EMS is active but has been bypassed by another mode of operation.
Car Reaction: EMS service is bypassed and the car operates under the new mode of operation.
Troubleshooting: 1. Check the current mode of operation and the EMS user settings.
Emergency Medical Service Deactivated
Description: EMS has been deactivated.
Car Reaction: Car is returned to prevailing mode of operation.
Troubleshooting: NA
Emergency Medical Service In-Car Activated (Switch 'n'), EMS In-car (Switch 'n') (n = 1 or 2)
Description: EMS In-Car service is activated via the in-car EMS key-switch. This is also referred to as the EMS Phase II operation.
Car Reaction: The car remains out of hall call service. Car calls are enabled again and the car can be dispatched from inside the car with car calls only. After answering a car call, doors will open automatically and close with constant pressure on the Door Close Button only.
Troubleshooting: 1. The EMS In-Car can be terminated by taking the car to the EMS recall floor by registering a car call then deactivating the in-car EMS switch. 2. The In-Car operation can also be terminated by simply removing the in-car EMS switch from the pre-programmed IO configuration. 3. Related inputs: EMSCarSwitch0: Normally low EMSCarSwitch1: Normally low
Emergency Medical Service Recall Activated (Switch 'n'), EMS Recall (Switch 'n') (n = 1 or 2)
Description: EMS recall is activated via one of the EMS recall key-switches located next to the designated EMS elevator. This is also referred to as the EMS Phase I operation.
Car Reaction: Momentary activation of the EMS recall switch will initiate a recall to the user-defined EMS Recall floor. The car removes itself from car and hall call service. Once at the EMS recall floor, the door operation is in accordance to the user-defined door operation under EMS recall operation. The car will remain on EMS Phase I as long as the hall switch is activated. Once the hall switch is deactivated, the car will return to normal operation upon expiration of a user-defined timer if the in-car switch is not activated within that time.
Troubleshooting: 1. Verify that none of the hall EMS recall switches is activated. 2. The EMS Recall operation can also be terminated by simply removing the in-car EMS switch from the pre-programmed IO configuration. 3. Related inputs: EMSHallSwitch0: Normally low EMSHallSwitch1: Normally low
Emergency Power Activated
Description: Commercial power has been lost and power is now supplied by an emergency power generator.
Car Reaction: The car will make an emergency stop due to the momentary loss of power and will remain shut down until commanded to either lower to a pre-determined floor or proceed to the next available floor. Once all cars have reached a floor, one or more cars will be selected to run under the emergency power generator.
Troubleshooting: 1. Related inputs: EPI: Active level field adjustable.

Table 6.3 iControl Messages

iControl Messages
Emergency Power and no communication with group, EMERG PWR NO COMM
Description: iControl has detected that an emergency power condition exists and it has not established communication with the emergency power supervisor (typically a group controller).
Car Reaction: The car is not allowed to move to prevent overloading the emergency power generator. If the car is moving when the event occurs, the car will make an emergency stop. motor contactor and brake contactor are immediately dropped. The car is also shut down (calls and all other demands are canceled).
Troubleshooting: 1. If this condition exists and the system is NOT operating under emergency power, refer to the job prints and verify wiring to the controller Emergency Power status input. 2. Verify correct input state (high/low) on iView/Car Operation/Emergency Power/EPI Input setting. 3. Check group to car communication.
Emergency Power Deactivated. See Emergency Power Activated.
Description: This event is logged when commercial power is restored.
Troubleshooting: 1. Related inputs: EPI: Active level field adjustable.
Emergency Power Recall, EMERG POWER RECALL. See Emergency Power Activated.
Description: This event is logged when the elevator has been commanded to lower to the emergency power recall floor.
Car Reaction: The elevator proceeds to the user-defined emergency power recall floor. Door operation at the recall floor is in accordance with the user defined door operation under emergency power recall conditions.
Troubleshooting: 1. Related inputs: EPR: Normally low (high to lower the car) PTR: Normally low (low to lower the car)
Emergency Power Run, EMERG POWER RUN. See Emergency Power Activated.
Description: This elevator is allowed to respond to calls during emergency power operation.
Troubleshooting: 1. Related inputs (only on elevators with emergency power overlay operation) EPR: Normally low (low to run the car) PTR: Normally low (low to run the car)
Emergency Power Shutdown, EMERG POWER SHUTDOWN. See Emergency Power Activated.
Description: This event is logged when emergency power is initially activated or if communication with the emergency power supervisor has been lost while on emergency power.
Car Reaction: Emergency stop. Car removed from service.
Troubleshooting: 1. Related inputs: EPI: Active level field adjustable.

Table 6.3 iControl Messages

iControl Messages
Excessive Brake Feedback Fault, EXCESS BRAKE FDBK FLT
Description: After each brake activity, the controller checks to see that brake current is bleeding off properly. (After 1 second, brake voltage should be at or below 85% of the voltage applied by the last command.) This fault is issued if brake voltage remains too high when checked by the controller.
Car Reaction: Emergency stop: Motor contactor and brake contactor immediately dropped.
Troubleshooting: <ol style="list-style-type: none"> 1. From the factory, RB (brake resistor circuit value) is set 3 to 5 times the brake coil resistance. Reduce RB to allow current to bleed off more quickly. (Do not reduce RB below 3 times brake coil resistance.) Please refer to "Verifying Brake Current Resistance" on page 2-22. 2. On the iView Brake screen, Timers tab, reduce Voltage Decay Time (minimum, 0.0 seconds). 3. Check Brake Voltage Feedback test point on iView Oscilloscope screen. 4. Check iField Brake Module connections. 5. Check brake and brake connections. 6. If you continue to see this fault after taking the above steps, you may have a defective brake module or iBox Safety board.
Excessive Faults Shutdown, EXCESSIVE FAULTS
Description: When there are five faults that resulted in an Emergency, Control, or ASAP stop within ten normal runs, this fault is generated.
Car Reaction: Emergency stop: Motor contactor and brake contactor immediately dropped. This is a latching fault. The Fault Reset button on the iBox must be pressed to clear it.
Troubleshooting: <ol style="list-style-type: none"> 1. Check Event Log to see what drive faults were generated before this fault was triggered. Refer to those drive faults for troubleshooting information.
Excessive Motor Field Feedback Fault, EXCESS MF FDBK FAULT
Description: Excessive current was detected flowing through the motor field. Threshold is set to 85% of forcing current for more than 4 seconds. If the fault is recurring, excessive faults will be generated and the motor field module will be disabled.
Car Reaction: Emergency Stop.
Troubleshooting: Problem may be related to faulty motor field module, faulty iBox, or invalid motor field calibration. <ol style="list-style-type: none"> 1. If excessive faults (fault) has been generated, the module is disabled and should not be outputting any voltage. If this is not the case, there may be a problem with the motor field module. 2. Calibrate the motor field. During calibration, the current and voltage should start at their maximum value and decrease as calibration proceeds. If this is not the case, there may be a problem with the iBox.
Excessive Relevels Fault, EXCESS RELEVELS FAULT
Description: The car has failed to relevel after ten attempts.
Car Reaction: Cancel all calls and shutdown. The doors are cycled and the car remains shutdown until the fault is reset by pressing the iBox Fault Reset button, toggling Inspection or cycling power to the controller.
Troubleshooting: <ol style="list-style-type: none"> 1. Check for mechanical or other failure preventing proper releveling. 2. Adjust brake and motor control during releveling with a full load in the car.
Excessive Restarts Fault, EXCESS RESTARTS FAULT
Description: The elevator has attempted to start movement from the same floor successively for an excessive number of times. This fault is issued after twenty-five attempts. The counter is reset if the car makes one successful run.
Car Reaction: Cancel all calls and shutdown. The doors are cycled and the car remains shutdown for five minutes after the first fault or until the fault is reset by pressing the iBox Fault Reset button, toggling Inspection or cycling power to the controller.
Troubleshooting: <ol style="list-style-type: none"> 1. Check for mechanical or other failure preventing car from moving away from floor the floor.

Table 6.3 iControl Messages

iControl Messages
Excessive Restarts Warning
Description: The elevator has attempted to start movement from the same floor successively for an excessive number of times. This fault is issued after ten attempts. The counter is reset if the car makes one successful run.
Car Reaction: None.
Troubleshooting: 1. Check for mechanical or other failure preventing car from moving away from floor the floor.
Exercise Operation Activated, EXERCISE OPERATION
Description: The car has been idle for a predetermined user-defined time and is now performing a user-defined number of Exercise operation runs.
Car Reaction: The car lowers to the bottom landing, then proceeds to the top landing and back down to the bottom landing without cycling the doors. Moving the car to the top landing and then back down to the bottom landing is considered one exercise run. The user defines the number of exercise runs.
Exercise Operation Deactivated
Description: The car has completed all of the exercise runs or Exercise operation has been terminated due to change in mode of operation or calls being entered into the system.
Fault Bypass Switch On, FAULT BYPASS SW ON
Description: The iBox Fault Bypass switch is in the ON position.
Car Reaction: None.
Fault Bypass Switch Timed Out, FLT BYP SW TIMED OUT
Description: Indicates that a fault bypass has timed out. (Bypasses are allowed for 15 minutes with the iBox Fault/Function Bypass switch in the ON position.)
Car Reaction: Emergency stop: Motor contactor and brake contactor immediately dropped.
Troubleshooting: 1. To clear this fault, place the Fault/Function Bypass switch to the OFF position.
F DPM OPEN-GS CLOSED. See Front DPM Open - GS Closed.
F DR CLS FLT REC FAIL. See Front Door Close Fault Recovery Failure
Field Module Over Temperature Fault, FIELD MODULE OVR TEMP
Description: The temperature of the Motor Field module heat sink is excessive (DC only).
Car Reaction: Stop at the next floor. Restart not permitted.
Troubleshooting: 1. Check machine room ambient temperature (should not exceed 104 degrees F or 40 degrees C). 2. Verify that air enters through the bottom of the power box and is only expelled via the fan at the top of the power box. 3. Check for insufficient air circulation through the power box. 4. Check the running temperature inside the power box (should not exceed 105 degrees F). 5. Check for faulty field module. 6. Check for faulty iBox. 7. Check for faulty connection between motor field module and iBox.
Fire Service In-car Activated, Fire Service In-car, Fire Svc In-car
Description: In-car firefighters service has been activated via the in-car fire service key-switch.
Car Reaction: Car and Door operation is in accordance to the user-defined fire code. (iView/Car Operation/Fire Service.)
Troubleshooting: 1. Related inputs: FireIOn: Normally low FireIOff: Normally high FireIHold: Normally low

Table 6.3 iControl Messages

iControl Messages
Fire Service In-Car Deactivated
Description: In-car firefighter’s service has been deactivated.
Car Reaction: Car is returned to prevailing mode of operation.
Fire Service In-car Hold Operation
Description: Car is on in-car firefighter hold operation.
Car Reaction: Car is held at a floor, typically with doors open. Car calls and door close buttons are disabled.
Troubleshooting: 1. Check the in-car firefighter switch status and Fire II hold operation user settings.
Fire Service In-car Recall Operation
Description: A car on in-car firefighter operation is being recalled to the designated fire recall floor.
Car Reaction: Car proceeds to the designated fire recall floor. Once at the recall floor, door operation is according to the user-defined door operation under fire recall operation.
Troubleshooting: 1. Check the in-car firefighter switch status and Fire II operation user settings.
Fire Service Recall Alternate, Fire Recall Alternate, Fire Recall Alt.
Description: Fire recall to the alternate fire floor has been initiated.
Car Reaction: Car proceeds to the user-defined alternate fire recall floor. Once at the recall floor, door operation is according to the user-defined door operation under fire recall operation.
Troubleshooting: 1. If in error, inspect the fire sensor and switch inputs and connections. 2. Related Inputs: Smoke sensors and fire recall switches as indicated on the job prints.
Fire Service Recall Main, Fire Recall Main, Fire Recall Main
Description: Fire recall to the main fire floor has been initiated.
Car Reaction: Car proceeds to the user-defined main fire recall floor. Once at the recall floor, door operation is according to the user-defined door operation under fire recall operation.
Troubleshooting: 1. If in error, inspect the fire sensor and switch inputs and connections. 2. Related Inputs: Smoke sensors and fire recall switches as indicated on the job prints.
Fire Service Recall Deactivated
Description: Fire service recall operation has been deactivated.
Car Reaction: Car returns to its prevailing mode of operation.
Troubleshooting: NA
Flood Operation Activated, FLOOD OPERATION
Description: Flood operation has been activated via system command or hardware switch.
Car Reaction: A car in the flood zone area moves immediately to a floor outside the flood zone. The car will no longer service the floors in the flood zone until Flood Operation is deactivated.
Troubleshooting: Check the flood zone switch and the user interface command.
Flood Operation Deactivated
Description: Flood operation has been deactivated.
Car Reaction: The car will service all eligible floors.

Table 6.3 iControl Messages

iControl Messages
Floor Heat Detectors Activated, FLOOR HEAT DETECTORS
Description: One or more floor heat detector inputs are activated. The fire warning light will flash until all heat detectors have been reset. The fire-warning buzzer will sound until the car is shutdown at a floor.
Car Reaction: A car that is parked at a floor will open its doors and shut down. A car in motion will proceed in the current direction to the next available floor where the heat detector is not tripped. If all heat detectors in the current direction are tripped, the car will reverse direction and proceed to the first floor where the heat detector is not tripped. If again all heat detectors are tripped, the car shall proceed to the main fire recall floor unless the car is also on Fire Service, in which case the car will proceed to the appropriate fire recall floor. Once the car is stopped at a floor it shall automatically open its doors and shut down. Then, if the machine room or hoistway heat detectors are active, a signal is provided to disconnect the main power line and activate the sprinklers where available. Please refer to "Car Operation - Heat Detectors" on page 9-86.
Floor Heat Detectors Deactivated
Description: All floor heat detector inputs are deactivated.
Car Reaction: The car is allowed to run.
Floor Location Fault, FLOOR LOCATION FAULT
Description: Floor magnet location is recorded during the floor height learn procedure. The on and off positions for both the ULM and DLM sensors are recorded, for a total of four pieces of data for every floor magnet, front and rear. The controller watches for the floor magnets constantly and checks to see that each is in its learned location.
Car Reaction: Run to next stop, then shut down.
Troubleshooting:
<ol style="list-style-type: none"> 1. Usually, a magnet has shifted position or fallen off. 2. Check the clearance between the floor sensor board and the magnets. Set if necessary. (Sometimes this clearance will be off just enough to make some magnets fail to register properly.) 3. Re-learn floor heights. 4. Perform a Terminal synchronization.
Floor Sensor Fault, FLOOR SENSOR FAULT
Description: The system did not detect a floor sensor while performing floor synchronization. Terminal synchronization will be performed as a result.
Car Reaction: Normal stop.
Troubleshooting: Indicates that the elevator location in the hoistway is not where the system expected or the door zone sensor is not being detected.
<ol style="list-style-type: none"> 1. Fault will be generated if the car was moved while the controller was not powered. The system will detect movement of the elevator for only ten seconds after power is removed. This will be sufficient to accommodate the time required for an elevator to stop after power is removed when running at contract speed. 2. On Inspection, verify that the system is detecting the LU, DZ, and LD signals when the elevator passes a floor. The signals can be observed on the iView Floor Heights Configuration screen.

Table 6.3 iControl Messages

iControl Messages
Floor Synchronization Fault
Description: While performing floor synchronization, the system either did not receive edge position data from the cartop or did not detect a floor position magnet where expected.
Car Reaction: The car will stop and initiate terminal synchronization.
Troubleshooting: <ol style="list-style-type: none"> 1. Verify that the car was not moved after power was shut off. 2. Move the car past floors around the vicinity of the fault and verify the proper activation of the LU and LD sensors. 3. Verify that the system is communicating with the cartop (no Cartop Communication Fault). 4. Verify that the absolute and cartop positions change by the same amount and in the same direction while moving the car. 5. Verify that a magnet has not fallen off. 6. Check the clearance between the floor sensor board and the magnets. Sometimes this clearance will be off just enough to make some magnets fail to register properly. Adjust clearance if necessary. 7. Re-learn the floor heights. 8. The iLink, iLand or iBox may be faulty.
Front Door Close Fault, FRONT DOOR CLOSE FLT
Description: One or more front door failures to close have been detected. The controller will attempt to close the doors as defined by user parameters (door close protection timer and number of attempts) before declaring this fault. iView Car Operation/Doors tab.
Car Reaction: The doors will reopen fully. All car calls are canceled and car removes itself from hall call service (hall calls assigned to this car are canceled or reassigned to other cars if available). Doors may be closed using constant pressure on the front door close button.
Troubleshooting: <ol style="list-style-type: none"> 1. Door closed status is determined by the front door close limit and by the front door position monitor contact if applicable. Check the wiring of these signals. 2. Check the door close protection timer and number of closing attempts on the Car Operation - Doors tab.
Front Door Close Fault Recovery Failure, F DR CLS FLT REC FAIL
Description: The Door Close Fault Recovery timer starts when a Door Close Fault is generated. When the timer expires, the Door Close Fault is cleared to allow the doors to again attempt to close (see Front Door Close Fault). This is repeated the number of times specified by the Door Close Fault Recovery Attempts parameter. If the doors have failed to close when the number of attempts equals the recovery attempts parameter setting, the Front Door Close Fault Recovery Failure is generated.
Car Reaction: The car is not allowed to run until a mode change is detected or the doors are successfully closed via constant pressure on the Door Close Button.
Troubleshooting: <ol style="list-style-type: none"> 1. Door closed status is determined by the front door close limit and by the front door position monitor contact if applicable. Check the wiring of these signals. 2. Check the door close protection timer and number of closing attempts on the Car Operation - Doors tab.
Front Door Close Time-out
Description: A failure of the front door to close has been detected. The controller will attempt to close the doors for a period of time defined by the Closing protection timer parameter (Door Motor Protection Timers). If the timer elapses prior to the doors closing fully, this event is generated.
Car Reaction: Doors reopen fully and again attempt to close.
Troubleshooting: <ol style="list-style-type: none"> 1. Door closed status is determined by the front door close limit and by the front door position monitor contact if applicable. 2. Check the wiring of these signals. 3. Check the Closing protection timer (iView Car Operation Configuration/Doors Tab/General Tab/Door Motor Protection Timers).

Table 6.3 iControl Messages

iControl Messages
Front Door Contact Fault, FRONT DOOR CNTCT FLT
Description: A faulty front door contact (gate switch, door lock) has been detected. This is detected when the doors are in their fully open position and either the gate switch contact is closed or the doors appear to be locked.
Car Reaction: All car calls are canceled and the car removes itself from hall call service. The front doors are not allowed to close and the car is not allowed to run.
Troubleshooting: <ol style="list-style-type: none"> 1. Check the front door gate switch and door lock contact at the floor at which the car is located. 2. Check associated wiring for these signals.
Front Door Open Button Bypassed, FRONT DOB BYPASSED
Description: The front door open button has been continuously activated for a user-defined time and is now bypassed according to the user-defined setting. (iView/Car Operation/Doors/Advanced.)
Car Reaction: The front door open button is rendered inoperative.
Troubleshooting: <ol style="list-style-type: none"> 1. Check the corresponding input: Front Door - Open Button (Normally low). 2. The operation of the door open button can also be restored by setting the Door open button bypass option to off (unchecked) (Car Operation Configuration/Doors tab/Advanced dialog).
Front Door Open Fault, FRONT DOOR OPEN FAULT
Description: One or more front door failures to open fully have been detected. After repeated attempts to open the door (as specified by user parameters), a door open failure is declared. The amount of time allowed for the door to open and the number of attempts made are user parameters. iView Car Operation/Doors tab, plus Advanced dialog.
Car Reaction: The door stalls at its last position. Car calls are canceled and the car removes itself from hall call service (hall calls assigned to this car are canceled or reassigned to other cars if available). Doors may be moved via constant pressure on the door open and door close buttons.
Troubleshooting: <ol style="list-style-type: none"> 1. The door open status is determined by the front door open limit status. 2. Check the wiring of this signal. 3. Check the door open protection timer and number of open attempts on the Operation screen Doors tab and associated Advanced dialog.
Front Door Open Time-out
Description: A failure of the front door to open has been detected. The controller will attempt to open the doors for a period of time defined by the Opening protection timer parameter (Door Motor Protection Timers). If the timer elapses prior to the doors opening fully, this event is generated.
Car Reaction: The door open cycle is halted and the door is allowed to reclose. If so configured, repeated attempts will be made to open the door. Otherwise, the car is allowed to leave the landing once the doors are closed.
Troubleshooting: <ol style="list-style-type: none"> 1. Door open status is determined by the front door open limit and by the front door position monitor contact if applicable. 2. Check the wiring of these signals. 3. Check the Opening protection timer (iView Car Operation Configuration/Doors Tab/General Tab/Door Motor Protection Timers).
Front Doors Stopped, FRONT DOORS STOPPED
Description: The Door Stop button or Emergency Stop switch was activated causing the doors to be prevented from moving.
Car Reaction: The car is not allowed to move unless the doors are fully closed.
Troubleshooting: This condition can be cleared by activation of the Door Open button, Door Close button or if the car goes into Inspection or Fire Service mode, provided that the Door Stop input is off.

Table 6.3 iControl Messages

iControl Messages
Front DPM Open - GS Closed, F DPM OPEN-GS CLOSED
Description: The front door position monitoring contact is open while the gate switch is closed.
Car Reaction: None.
Troubleshooting: Check the front door position monitoring contact, gate switch and all related circuitry.
Front Hall Door Open Button Bypassed, FRONT HALL DOB BYP
Description: The front hall door open button has been continuously activated for a user-defined time (Door open bypass timer) and is now bypassed in accordance with the user-defined setting (Car Operation Configuration/Doors tab/Advanced dialog).
Car Reaction: The front hall door open button is rendered inoperative.
Troubleshooting:
<ol style="list-style-type: none"> 1. Check the corresponding input, Front Door - Hall Door Open Button: Normally low. 2. The operation of the hall door open button can also be restored by setting the Door open button bypass option to off (unchecked) (Car Operation Configuration/Doors tab/Advanced dialog).
Front Photo Eye Bypassed, FRONT PHOTO EYE BYP
Description: The front photo eye device has been continuously activated for a user-defined time and is now bypassed in accordance to the user-defined setting. (iView/Car Operation/Passenger/Anti Nuisance.)
Car Reaction: The front photo eye device is rendered inoperative.
Troubleshooting:
<ol style="list-style-type: none"> 1. To restore the operation of the photo eye device, check the corresponding input. 2. Related inputs: PhotoEyeFront: Normally low
Front Photo Eye Failure, FRONT PHOTO EYE FAIL
Description: This event is logged when the photo eye is continuously activated for a predetermined time (4 seconds) while the front doors are fully closed.
Car Reaction: The front photo eye is rendered inoperative.
Troubleshooting:
<ol style="list-style-type: none"> 1. Check for abnormal blockage or failure of the front optical device. 2. Related inputs: FrontPhotoEye: Normally low
Front Safe Edge Bypassed, FRONT SAFE EDGE BYP
Description: The front door safe edge has been continuously activated for a user-defined time and is now bypassed according to the user-defined setting. (iView/Car Operation/Common/Door Device Bypass Timers.)
Car Reaction: The front safe edge is rendered inoperative.
Troubleshooting:
<ol style="list-style-type: none"> 1. Check the state of the front safe edge input. 2. Related inputs: SafeEdgeFront: Normally low
Front Safe Edge Failure, FRONT SAFE EDGE FAIL
Description: This event is logged when the front door safe edge is continuously activated for a predetermined time (4 seconds) while the front doors are fully closed.
Car Reaction: The front door safe edge is rendered inoperative.
Troubleshooting:
<ol style="list-style-type: none"> 1. Check for abnormal blockage or failure of the front door mechanical reopening device. 2. Related inputs: FrontSafeEdge: Normally low

Table 6.3 iControl Messages

iControl Messages
Global Parameter Update, Reset Controller, PARAM CHNG-RESET CAR
Description: This message indicates that all of the controller parameters have been updated and it is necessary to reset the controller once the update is completed (press the iBox COMPUTER RESET button).
Car Reaction: The car is not allowed to run until the parameter update has been completed and the computer has been reset.
Governor open, GOVERNOR OPEN
Description: The Gov input has dropped. Will also cause an Ascending Car Overspeed Fault and set the rope gripper if running up.
Car Reaction: Emergency stop if running. The car is not allowed to run again until the problem is corrected.
Troubleshooting: 1. Check the GOV (Governor) input, connection, and function.
Governor Speed Reduction Switch Fault, GOV SPEED SWITCH FLT
Description: This fault is generated if the elevator is moving and the Governor Speed Reduction Switch input goes low (expansion input assigned via iView under Motor and Drive).
Car Reaction: Emergency Stop
Troubleshooting: Verify the state of the Governor Speed Reduction Switch and input.
Group Communication Established
Description: The car has established communication with the main iCue dispatcher.
Group Communication Lost
Description: Communication with the main iCue dispatcher has been lost.
Car Reaction: The car establishes communication with the backup dispatcher car if one has been selected. Otherwise the car goes into emergency dispatch mode if that operation is not bypassed via the hardware override switch.
Troubleshooting: Check the group to car communication related connections and parameters.
Hall Call Bus 'n' Failure, HALL CALL BUS 'n' FAIL (n = 1 to 4)
Description: There is no power to the named hall call bus.
Car Reaction: No response to calls from the affected floor.
Troubleshooting: 1. Check bus fuses and connections. 2. Test associated hall call bus driver.
Hall Call Bypass Input OFF (see Hall Cal Bypass Input ON)
Hall Call Bypass Input ON, HALL CALL BYPASS INP.
Description: Discrete input used to bypass hall calls.
Car Reaction: The car takes itself out of hall call service. Hall calls remain registered until answered. The car is also not eligible for parking
Troubleshooting: Check the related discrete inputs.
Hall Call Service Disabled
Description: The car is rejecting hall calls (iBox <i>IN GROUP</i> indicator is Off and the <i>Hall call reject</i> status LED on the iView Diagnostics > Diagnostic Outputs > Car Operation tab is On) either because of the current mode of operation (Inspection, Test, Independent service, Capture) or because of a fault condition.
Car Reaction: Hall calls are rejected.
Troubleshooting: 1. Verify that the car is not on a mode of operation in which hall calls are not accepted. 2. Check the iView Faults text box and Event Log for faults that would cause the car to reject hall calls. 3. If the car is not responding to hall calls, but neither 1 or 2 apply, the problem could be due to loss of communication with the dispatcher, security settings, heavy load status or hall call system malfunction.

Table 6.3 iControl Messages

iControl Messages
Hall Call Service Enabled (see Hall Call Service Disabled)
Description: The car is accepting hall calls (iBox <i>IN GROUP</i> indicator is On). See also, Hall Call Service Disabled.
Heat Detectors Recall Activated, HEAT DETECTORS RECALL
Description: A heat detector input has been activated.
Car Reaction: A car that is parked at a floor will open its doors and shut down. A car in motion will proceed in the current direction to the next available floor where the heat detector is not tripped. If all heat detectors in the current direction are tripped, the car will reverse direction and proceed to the first floor where the heat detector is not tripped. If again all heat detectors are tripped, the car shall proceed to the main fire recall floor unless the car is also on Fire Service, in which case the car will proceed to the appropriate fire recall floor. Once the car is stopped at a floor it shall automatically open its doors and shut down. Then, if the machine room or hoistway heat detectors are active, a signal is provided to disconnect the main power line and activate the sprinklers where available. Please refer to "Car Operation - Heat Detectors" on page 9-86.
Heat Detectors Recall Complete
Description: Indicates that the car has completed the Heat Detectors Recall operation (reached a floor and doors are fully open).
Car Reaction: The car remains shut down until all heat detector inputs have been deactivated (see Heat Detectors Recall Deactivated).
Heat Detectors Recall Deactivated
Description: All heat detector inputs are deactivated
Car Reaction: The car is allowed to run.
Heat Sensor Fault 'n' (n = 2 to 4)
Description: Not currently used.
Hoistway Access Disabled, HA INSP. DISABLED
Description: Hoistway access inspection operation has been disabled.
Car Reaction: The car cannot be run on hoistway access inspection operation.
Troubleshooting:
<ol style="list-style-type: none"> 1. Check for any car status that might prevent hoistway access inspection operation, e.g. earthquake. 2. Check for the Stuck Inspection Input Fault. 3. Check all inspection buttons (Enable, Up, Down) and verify that none are stuck in the ON position.
Hoistway Access Enabled
Description: Hoistway access inspection operation which was previously disabled is now enabled.
Hoistway Access Inspection Operation, Hoistway Access Operation, Hoistway Access
Description: Car is on Hoistway access (enabled by the Hoistway access switch).
Car Reaction: If running, the car will make an emergency stop and is taken out of normal service. Under this mode of operation, car can only be moved manually using the access key switches.
Troubleshooting:
<ol style="list-style-type: none"> 1. Related inputs: HoistwayAccess: Normally high
Hoistway Door Bypass, HOISTWAY DOOR BYPASS
The Hoistway Door Bypass switch on the iBox is in the Bypass position. (View-only on iView Safety screen, enabled/disabled by MCE according to safety jurisdiction.) The ability to set this bypass must be enabled at the factory and is only available if allowed by safety regulations in your area. Check the iView Safety Configuration screen to see if the feature is enabled in your installation.
Description:
Car Reaction: The car is placed in Inspection mode. To move the car, you must place it in either cartop or car panel inspection mode. No other modes of operation are allowed.

Table 6.3 iControl Messages

iControl Messages
Hoistway Heat Detectors Activated, HOIST HEAT DETECTORS
Description: The hoistway heat detector input is activated. The fire warning light will flash until all heat detectors have been reset. The fire-warning buzzer will sound until the car is shutdown at a floor.
Car Reaction: A car that is parked at a floor will open its doors and shut down. A car in motion will proceed in the current direction to the next available floor where the heat detector is not tripped. If all heat detectors in the current direction are tripped, the car will reverse direction and proceed to the first floor where the heat detector is not tripped. If again all heat detectors are tripped, the car shall proceed to the main fire recall floor unless the car is also on Fire Service, in which case the car will proceed to the appropriate fire recall floor. Once the car is stopped at a floor it shall automatically open its doors and shut down. Then, if the machine room or hoistway heat detectors are active, a signal is provided to disconnect the main power line and activate the sprinklers where available. Please refer to "Car Operation - Heat Detectors" on page 9-86.
Hoistway Heat Detectors Deactivated
Description: The hoistway heat detector input is deactivated.
Car Reaction: The car is allowed to run.
HOISTWAY LEARN ON
Description: This status message, on the iBox display, indicates that the system is ready to perform the hoistway learn operation.
IMP Switch Fault - Car Door Bypass, IMP SW FLT:C DOOR BP
Description: There is a problem with the iBox CAR DOOR BYPASS switch. Both poles must activate.
Car Reaction: None
Troubleshooting: <ol style="list-style-type: none"> Sometimes the switch fault can be temporarily cleared by toggling the switch multiple times. The iBox slide switches can be repaired using MCE part: IMP-SW-JUMPER-KIT.
IMP Switch Fault - Emergency Stop, IMP SW FAULT: EM STOP
Description: There is a problem with the iBox CONTROLLER STOP switch. Both poles must activate.
Car Reaction: If stopped, the car is immediately shut down and taken out of service for all types of demands, including fire and medical emergencies. If the switch fault is detected while running, the car is allowed to reach its next destination before shutting down.
Troubleshooting: <ol style="list-style-type: none"> Sometimes the switch fault can be temporarily cleared by toggling the switch multiple times. The iBox slide switches can be repaired using MCE part: IMP-SW-JUMPER-KIT.
IMP Switch Fault - Fault Bypass, IMP SW FAULT: FLT BYP
Description: There is a problem with the iBox FAULT/FUNCTION BYPASS switch. Both poles must activate.
Car Reaction: None
Troubleshooting: <ol style="list-style-type: none"> Sometimes the switch fault can be temporarily cleared by toggling the switch multiple times. The iBox slide switches can be repaired using MCE part: IMP-SW-JUMPER-KIT.
IMP Switch Fault - Hoistway Door Bypass, IMP SW FLT: H DOOR BP
Description: There is a problem with the iBox HOISTWAY DOOR BYPASS switch. Both poles must activate.
Car Reaction: None
Troubleshooting: <ol style="list-style-type: none"> Sometimes the switch fault can be temporarily cleared by toggling the switch multiple times. The iBox slide switches can be repaired using MCE part: IMP-SW-JUMPER-KIT.

Table 6.3 iControl Messages

iControl Messages
IMP Switch Fault - Inspection, IMP SW FAULT: INSP
Description: There is a problem with the iBox INSPECTION switch. Both poles must activate.
Car Reaction: If stopped, the car is immediately shut down and taken out of service for all types of demands, including fire and medical emergencies. If the switch fault is detected while running, the car is allowed to reach its next destination before shutting down.
Troubleshooting: 1. Sometimes the switch fault can be temporarily cleared by toggling the switch multiple times. 2. The iBox slide switches can be repaired using MCE part: IMP-SW-JUMPER-KIT.
IMP Switch Fault - Inspection DOWN, IMP SW FAULT: INSP DN
Description: There is a problem with the iBox Inspection DOWN switch. Both poles must activate.
Car Reaction: None
IMP Switch Fault - Inspection Enable, IMP SW FAULT: INSP EN
Description: There is a problem with the iBox Inspection ENABLE switch. Both poles must activate.
Car Reaction: None
IMP Switch Fault - Inspection UP, IMP SW FAULT: INSP UP
Description: There is a problem with the iBox Inspection UP switch. Both poles must activate.
Car Reaction: None
IMP Switch Fault - Learn, IMP SW FAULT: LEARN
Description: There is a problem with the iBox LEARN switch. Both poles must activate.
Car Reaction: None
Troubleshooting: 1. Sometimes the switch fault can be temporarily cleared by toggling the switch multiple times. 2. The iBox slide switches can be repaired using MCE part: IMP-SW-JUMPER-KIT.
IMP Switch Fault - None
Description: This message is generated when an IMP switch fault has occurred and is then cleared. If multiple switch faults occur at the same time, the message is generated when all faults have been cleared.
Car Reaction: If the car had been shut down due to the IMP switch faults, it is cleared to run again.
IMP Switch Fault - Test, IMP SW FAULT: TEST
Description: There is a problem with the iBox TEST switch. Both poles of this switch must activate.
Car Reaction: None
Troubleshooting: 1. Sometimes the switch fault can be temporarily cleared by toggling the switch multiple times. 2. The iBox slide switches can be repaired using MCE part: IMP-SW-JUMPER-KIT.
IMP Switch Fault - Write Enable, IMP SW FLT: WRITE EN
Description: There is a problem with the iBox WRITE ENABLE switch. Both poles must activate.
Car Reaction: None
Troubleshooting: 1. Sometimes the switch fault can be temporarily cleared by toggling the switch multiple times. 2. The iBox slide switches can be repaired using MCE part: IMP-SW-JUMPER-KIT.
Independent Service, Independent Svc
Description: Indicates that the Independent Service switch has been activated.
Car Reaction: Car and door operation in accordance to user-defined settings for independent service. (iView/Car Operation/Independent Service.) Car does not respond to hall calls.
Troubleshooting: 1. If reported in error, check the Independent Service switch and wiring.

Table 6.3 iControl Messages

iControl Messages
Inspection Operation, Inspection
Description: The car is operating in Inspection mode.
Car Reaction: One of the inspection modes (in-car, machine room, or cartop) is active. The car will operate using the Inspection performance pattern.
Inspection Overspeed Fault
Description: While operating in Inspection mode, the car exceeded the Inspection Overspeed setting on the iView Safety Configuration screen.
Car Reaction: Emergency stop: Motor contactor and brake contactor immediately dropped.
Troubleshooting:
<ol style="list-style-type: none"> 1. The fault will automatically clear 5 seconds after the car stops. The car is then allowed to run again. 2. If reported in error, check the Inspection Overspeed setting on the Safety Configuration screen. 3. Check the iView event log for any events immediately preceding the overspeed fault. 4. Determine and correct the cause of the overspeed.
Insufficient Brake Feedback Fault, INSF CNT BRK FDBK FLT
Description: Brake current feedback is abnormally low.
Car Reaction: Emergency stop: Motor contactor and brake contactor immediately dropped.
Troubleshooting:
<ol style="list-style-type: none"> 1. Check DB-25 connector from iField module to iBox is seated properly. 2. Check power supply on brake iField module. 3. Verify brake voltage parameters. 4. Verify iField Module setting for terminals FMCI and FMHC. Please refer to "IFIELD-MODULE Terminals on the ICE-FMP Board (Brake Module)" on page 6-95. 5. Verify that the brake is properly calibrated. Please refer to "Drive Offsets Calibration" on page 2-48. Please refer to "Brake Parameter Adjustments" on page 4-20. 6. Check Brake voltage on the Operational Status tab. If the value goes below 0.00 volts, and/or the drive offset (Input ADC) was recently calibrated or adjusted, verify / set the Input ADC = 0.0 on the Configuration > Drive > Calibration tab.
Insufficient Motor Field Feedback Fault, INSF CNT MF FDBK FLT
Description: Indicates that Motor Current Feedback signal is less than 50% of the commanded field current.
Car Reaction: If detected four times over seven runs the car will shut down.
Troubleshooting:
<ol style="list-style-type: none"> 1. Check motor field AC supply off isolation transformer. 2. Check connections from controller to motor. 3. Check connections to iField motor module. 4. Check for open fuses. 5. Recalibrate motor field.
Insufficient Motor Field Forcing Feedback Fault, INSF CNT MF FORCNG FLT
Description: Motor field voltage is inadequate. DC motors only.
Car Reaction:
Troubleshooting:
<ol style="list-style-type: none"> 1. Verify motor field voltage parameters. 2. The motor field may be improperly calibrated. Check settings (iView Motor Configuration screen). 3. Recalibrate motor field if necessary.
Invalid Configuration BALRQ, INVALID CNFG BALRQ
Description: Bottom Access Landing Rear Qualifier. The safety system has detected the improper use of BALRQ option on the iView safety configuration screen.
Car Reaction: Safety OK status remains off.
Troubleshooting:
<ol style="list-style-type: none"> 1. Check that the Safety Configuration, Bottom Access Landing Rear option is properly set.

Table 6.3 iControl Messages

iControl Messages
Invalid Configuration Input, INVALID CNFG INPUT
Description: An invalid input was discovered when cross checking safety inputs against safety configuration.
Car Reaction: Emergency stop: Motor contactor and brake contactor immediately dropped.
Troubleshooting: 1. Check car setup/wiring against Safety Screen configuration. 2. Press Fault Reset to clear. 3. Re-learn Safety Configuration. Please refer to "Setup - Safety - Configuration Tab" on page 9-147.
Invalid Configuration Input Off (See: Invalid Configuration Input)
Invalid Configuration Input CTEX, INVLD CNFG INPUT CTEX
Description: Cartop Emergency Exit. The safety system detected an input/safety setting difference when cross checking inputs against configuration.
Car Reaction: Emergency stop: Motor contactor and brake contactor immediately dropped.
Troubleshooting: 1. Verify car setup/wiring matches the Safety screen setting for the option. 2. Press Fault Reset to clear. 3. Re-learn the Safety Configuration.
Invalid Configuration Input DCAB, INVLD CNFG INPUT DCAB
Description: Door Close Access Bottom. The safety system detected an input/safety setting difference when cross checking inputs against configuration.
Car Reaction: Emergency stop: Motor contactor and brake contactor immediately dropped.
Troubleshooting: 1. Verify car setup/wiring matches the Safety screen setting for the option. 2. Press Fault Reset to clear. 3. Re-learn the Safety Configuration.
Invalid Configuration Input DCAT, INVLD CNFG INPUT DCAT
Description: Door Close Access Top. The safety system detected an input/safety setting difference when cross checking inputs against configuration.
Car Reaction: Emergency stop: Motor contactor and brake contactor immediately dropped.
Troubleshooting: 1. Verify car setup/wiring matches the Safety screen setting for the option. 2. Press Fault Reset to clear. 3. Re-learn the Safety Configuration.
Invalid Configuration Input DCMS, INVLD CNFG INPUT DCMS
Description: Door Close Main String. The safety system detected an input/safety setting difference when cross checking inputs against configuration.
Car Reaction: Emergency stop: Motor contactor and brake contactor immediately dropped.
Troubleshooting: 1. Verify car setup/wiring matches the Safety screen setting for the option. 2. Press Fault Reset to clear. 3. Re-learn the Safety Configuration.
Invalid Configuration Input DCMS R, INV CNFG INPUT DCMS R
Description: Door Close Main String Rear. The safety system detected an input/safety setting difference when cross checking inputs against configuration.
Car Reaction: Emergency stop: Motor contactor and brake contactor immediately dropped.
Troubleshooting: 1. Verify car setup/wiring matches the Safety screen setting for the option. 2. Press Fault Reset to clear. 3. Re-learn the Safety Configuration.

Table 6.3 iControl Messages

iControl Messages
Invalid Configuration Input DLAB, INVLD CNFG INPUT DLAB
Description: Door Lock Access Bottom. The safety system detected an input/safety setting difference when cross checking inputs against configuration.
Car Reaction: Emergency stop: Motor contactor and brake contactor immediately dropped.
Troubleshooting: 1. Verify car setup/wiring matches the Safety screen setting for the option. 2. Press Fault Reset to clear. 3. Re-learn the Safety Configuration.
Invalid Configuration Input DLAT, INVLD CNFG INPUT DLAT
Description: Door Lock Access Top. The safety system detected an input/safety setting difference when cross checking inputs against configuration.
Car Reaction: Emergency stop: Motor contactor and brake contactor immediately dropped.
Troubleshooting: 1. Verify car setup/wiring matches the Safety screen setting for the option. 2. Press Fault Reset to clear. 3. Re-learn the Safety Configuration.
Invalid Configuration Input DLMS, INVLD CNFG INPUT DLMS
Description: Door Lock Main String. The safety system detected an input/safety setting difference when cross checking inputs against configuration.
Car Reaction: Emergency stop: Motor contactor and brake contactor immediately dropped.
Troubleshooting: 1. Verify car setup/wiring matches the Safety screen setting for the option. 2. Press Fault Reset to clear. 3. Re-learn the Safety Configuration.
Invalid Configuration Input DLMS R, INV CNFG INPUT DLMS R
Description: Door Lock Main String Rear. The safety system detected an input/safety setting difference when cross checking inputs against configuration.
Car Reaction: Emergency stop: Motor contactor and brake contactor immediately dropped.
Troubleshooting: 1. Verify car setup/wiring matches the Safety screen setting for the option. 2. Press Fault Reset to clear. 3. Re-learn the Safety Configuration.
Invalid Configuration Input DPM, INVLD CNFG INPUT DPM
Description: Door Position Monitoring. The safety system detected an input/safety setting difference when cross checking inputs against configuration.
Car Reaction: Emergency stop: Motor contactor and brake contactor immediately dropped.
Troubleshooting: 1. Verify car setup/wiring matches the Safety screen setting for the option. 2. Press Fault Reset to clear. 3. Re-learn the Safety Configuration.
Invalid Configuration Input DPM_R, INV CNFG INPUT DPM_R
Description: Door Position Monitoring Rear. The safety system detected an input/safety setting difference when cross checking inputs against configuration.
Car Reaction: Emergency stop: Motor contactor and brake contactor immediately dropped.
Troubleshooting: 1. Verify car setup/wiring matches the Safety screen setting for the option. 2. Press Fault Reset to clear. 3. Re-learn the Safety Configuration.

Table 6.3 iControl Messages

iControl Messages
Invalid Configuration TALRO, INVALID CNFG TALRO
Description: Top Access Landing Rear Qualifier. The safety system detected an input/safety setting difference when cross checking inputs against configuration.
Car Reaction: Safety OK remains off.
Troubleshooting: <ol style="list-style-type: none"> 1. Verify car setup/wiring matches the Safety screen setting for the option. 2. Press Fault Reset to clear. 3. Re-learn the Safety Configuration.
Invalid Configuration Inventory Cross Check BALRO, INV INVTRY XCHK BALRO
Description: Bottom Access Landing Rear Qualifier. The safety system detected a configuration/inventory (board complement) difference when cross checking board complement against system configuration.
Car Reaction: Safety OK remains off.
Troubleshooting: <ol style="list-style-type: none"> 1. Verify that the Configuration settings on the Setup > Safety > Configuration tab match the car options/wiring. Any rear door options require a rear door board be attached to the safety expansion bus. Likewise, a rear door board attached to the safety expansion bus requires at least one rear door option be selected on the Safety Configuration (Setup > Safety > Configuration tab). 2. If the safety configuration is incorrect, make appropriate changes and re-learn the new configuration using the Learn operation on the Setup > Safety > Configuration tab. 3. Re-learn the inventory of boards using the Inventory Learn procedure on the Setup > Safety > Inventory tab. 4. Reset the fault (press the iBox FAULT RESET button).
Invalid Configuration Inventory Cross Check DCCOR, INV INVTRY XCHK DCCOR
Description: Door Close Contact Rear. The safety system detected a configuration/inventory (board complement) difference when cross checking board complement against system configuration.
Car Reaction: Safety OK remains off.
Troubleshooting: <ol style="list-style-type: none"> 1. Verify that the Configuration settings on the Setup > Safety > Configuration tab match the car options/wiring. Any rear door options require a rear door board be attached to the safety expansion bus. Likewise, a rear door board attached to the safety expansion bus requires at least one rear door option be selected on the Safety Configuration (Setup > Safety > Configuration tab). 2. If the safety configuration is incorrect, make appropriate changes and re-learn the new configuration using the Learn operation on the Setup > Safety > Configuration tab. 3. Re-learn the inventory of boards using the Inventory Learn procedure on the Setup > Safety > Inventory tab. 4. Reset the fault (press the iBox FAULT RESET button).
Invalid Configuration Inventory Cross Check NMS R, INV INVTRY XCHK NMS R
Description: No Main String Rear. The safety system detected a configuration/inventory (board complement) difference when cross checking board complement against system configuration.
Car Reaction: Safety OK remains off.
Troubleshooting: <ol style="list-style-type: none"> 1. Verify that the Configuration settings on the Setup > Safety > Configuration tab match the car options/wiring. Any rear door options require a rear door board be attached to the safety expansion bus. Likewise, a rear door board attached to the safety expansion bus requires at least one rear door option be selected on the Safety Configuration (Setup > Safety > Configuration tab). 2. If the safety configuration is incorrect, make appropriate changes and re-learn the new configuration using the Learn operation on the Setup > Safety > Configuration tab. 3. Re-learn the inventory of boards using the Inventory Learn procedure on the Setup > Safety > Inventory tab. 4. Reset the fault (press the iBox FAULT RESET button).

Table 6.3 iControl Messages

iControl Messages
Invalid Configuration Inventory Cross Check RD Board, INV INVTRY XCHK RD BD
Description: Rear Door board. The safety system detected a configuration/inventory (board complement) difference when cross checking board complement against system configuration.
Car Reaction: Safety OK remains off.
Troubleshooting: <ol style="list-style-type: none"> 1. Verify that the Configuration settings on the Setup > Safety > Configuration tab match the car options/wiring. Any rear door options require a rear door board be attached to the safety expansion bus. Likewise, a rear door board attached to the safety expansion bus requires at least one rear door option be selected on the Safety Configuration (Setup > Safety > Configuration tab). 2. If the safety configuration is incorrect, make appropriate changes and re-learn the new configuration using the Learn operation on the Setup > Safety > Configuration tab. 3. Re-learn the inventory of boards using the Inventory Learn procedure on the Setup > Safety > Inventory tab. 4. Reset the fault (press the iBox FAULT RESET button).
Invalid Configuration Inventory Cross Check RDOPT, INV INVTRY XCHK RDOPT
Description: Rear Door Option. The safety system detected a configuration/inventory (board complement) difference when cross checking board complement against system configuration.
Car Reaction: Safety OK remains off.
Troubleshooting: <ol style="list-style-type: none"> 1. Verify that the Configuration settings on the Setup > Safety > Configuration tab match the car options/wiring. Any rear door options require a rear door board be attached to the safety expansion bus. Likewise, a rear door board attached to the safety expansion bus requires at least one rear door option be selected on the Safety Configuration (Setup > Safety > Configuration tab). 2. If the safety configuration is incorrect, make appropriate changes and re-learn the new configuration using the Learn operation on the Setup > Safety > Configuration tab. 3. Re-learn the inventory of boards using the Inventory Learn procedure on the Setup > Safety > Inventory tab. 4. Reset the fault (press the iBox FAULT RESET button).
Invalid Configuration Inventory Cross Check RG Board, INV INVTRY XCHK RG BD
Description: Rope Gripper board. The safety system detected a configuration/inventory (board complement) difference when cross checking board complement against system configuration.
Car Reaction: Safety OK remains off.
Troubleshooting: <ol style="list-style-type: none"> 1. Verify that the Configuration settings on the Setup > Safety > Configuration tab match the car options/wiring. Any emergency brake options require an emergency brake board be attached to the safety expansion bus. Likewise, a emergency brake board attached to the safety expansion bus requires at least one emergency brake option be selected on the Safety Configuration (Setup > Safety > Configuration tab). 2. If the safety configuration is incorrect, make appropriate changes and re-learn the new configuration using the Learn operation on the Setup > Safety > Configuration tab. 3. Re-learn the inventory of boards using the Inventory Learn procedure on the Setup > Safety > Inventory tab. 4. Reset the fault (press the iBox FAULT RESET button).

Table 6.3 iControl Messages

iControl Messages
Invalid Configuration Inventory Cross Check RGOPT, INV INVTRY XCHK RGOPT
Description: Rope Gripper Option. The safety system detected a configuration/inventory (board complement) difference when cross checking board complement against system configuration.
Car Reaction: Safety OK remains off.
Troubleshooting: <ol style="list-style-type: none"> 1. Verify that the Configuration settings on the Setup > Safety > Configuration tab match the car options/wiring. Any emergency brake options require an emergency brake board be attached to the safety expansion bus. Likewise, a emergency brake board attached to the safety expansion bus requires at least one emergency brake option be selected on the Safety Configuration (Setup > Safety > Configuration tab). 2. If the safety configuration is incorrect, make appropriate changes and re-learn the new configuration using the Learn operation on the Setup > Safety > Configuration tab. 3. Re-learn the inventory of boards using the Inventory Learn procedure on the Setup > Safety > Inventory tab. 4. Reset the fault (press the iBox FAULT RESET button).
Invalid Configuration Inventory Cross Check TALRO, INV INVTRY XCHK TALRO
Description: Top Access Landing Rear Qualifier. The safety system detected a configuration/inventory (board complement) difference when cross checking board complement against system configuration.
Car Reaction: Safety OK remains off.
Troubleshooting: <ol style="list-style-type: none"> 1. Verify that the Configuration settings on the Setup > Safety > Configuration tab match the car options/wiring. Any rear door options require a rear door board be attached to the safety expansion bus. Likewise, a rear door board attached to the safety expansion bus requires at least one rear door option be selected on the Safety Configuration (Setup > Safety > Configuration tab). 2. If the safety configuration is incorrect, make appropriate changes and re-learn the new configuration using the Learn operation on the Setup > Safety > Configuration tab. 3. Re-learn the inventory of boards using the Inventory Learn procedure on the Setup > Safety > Inventory tab. 4. Reset the fault (press the iBox FAULT RESET button).
Invalid Destination, INVALID DESTINATION
Description: The car has been assigned to a destination floor that does not have an opening.
Car Reaction: Car ignores the demand.
Troubleshooting: Check the current mode of operation and check the corresponding recall floor and verify that the floor is set to a floor with an opening.
Invalid Front Door Position, INVLD FRONT DOOR PSTN
Description: The front door inputs are in an invalid state (i.e.: doors open and closed at the same time).
Car Reaction: Car is taken out of service and doors will stall.
Troubleshooting: <ol style="list-style-type: none"> 1. Check all the front door inputs and wiring. 2. Related inputs: FrontDoorCloseLimit: Low when the doors are fully closed FrontDoorPositionMonitoring: High when the doors are fully closed FrontDoorOpenLimit: Low when doors are fully open FrontCarGate: High when doors are fully closed
Invalid Input (See: Invalid Configuration Input)

Table 6.3 iControl Messages

iControl Messages
Invalid Rear Door Position, INVLD REAR DOOR PSTN
Description: The rear door inputs are in an invalid state (i.e., doors open and closed at the same time).
Car Reaction: Car is taken out of service and doors will stall.
Troubleshooting: 1. Check all the rear door inputs and wiring. 2. Related inputs: RearDoorCloseLimit: Low when the doors are fully closed RearDoorPositionMonitoring: High when the doors are fully closed RearDoorOpenLimit: Low when doors are fully open RearCarGate: High when doors are fully closed
IO Map Compare Fault, IO MAP COMPARE FAULT
Description: Safety A IO Map did not match Safety B IO Map.
Car Reaction: If running, car makes an emergency stop. Car is not allowed to run.
Troubleshooting: 1. Press the Fault Reset button to clear the fault. 2. If problem persists it is an indication that the iBox may need to be replaced. Consult MCE Technical Support for instructions.
IO Map Compare Fault Off (See: IO Map Compare Fault)
IO Map Compare Long Term Fault, IO MAP COMPARE LT FLT
Description: Safety A long term products did not match Safety B long term products for 1.2 seconds.
Car Reaction: If running, car makes an emergency stop. Car is not allowed to run.
Troubleshooting: 1. Press the Fault Reset button to clear the fault. 2. If problem persists it is an indication that the iBox may need to be replaced. Consult MCE Technical Support for instructions.
IO Map Toggle Compare Fault, IO MAP TOGGLE COMP FLT
Description: The failure of a safety input was detected during the “input toggle test” (performed at the end of each run). This test verifies the proper operation of safety system inputs that normally remain unchanged during the course of elevator operation.
Car Reaction: Emergency stop: Motor contactor and brake contactor immediately dropped.
Troubleshooting: 1. Press the Fault Reset button to clear the fault. 2. If problem persists it is an indication that the iBox may need to be replaced. Consult MCE Technical Support for instructions.
IO Map Toggle Compare Fault Off (See: IO Map Toggle Compare Fault)
iView Logged Off. Passenger operation. A previously active iView connection to the controller has logged off.
iView Logged On. Passenger operation. An iView user has logged on to the controller.
iView Lost Connection. An iView connection has been dropped.
iView Timed Out. An iView connection was inactive for a period of time beyond the idle timeout and has been disconnected.

Table 6.3 iControl Messages

iControl Messages
Landing System Sensor Fault, LAND SYS SENSOR FAULT
Description: This fault is generated when a ULM or DLM sensor is activated while the car is running and is away from a floor. It can also be generated if the M contactor is ON (car is commanded to run) and the safety system sees a door zone magnet for more than 16 inches of single direction travel.
Car Reaction: Emergency Stop. Motor and brake contactors immediately dropped.
Troubleshooting: <ol style="list-style-type: none"> 1. Press Fault Reset to clear. 2. If allowed, set Contactor Drop Delay Time to 0.9 seconds. 3. Check for stuck door zone sensor input (front or rear).
LCD Fault
Description: This fault is generated if the controller gets a “not ready” state from the LCD. This can happen if the iBox LCD is not connected properly or, with some LCD models, if the contrast is set to far to an extreme.
Car Reaction: None. The fault is simply an indication to adjust or replace the iBox LCD.
Troubleshooting: <ol style="list-style-type: none"> 1. Check the iBox Onboard Display LCD. If the LCD is blank or frozen, adjust the contrast dial to midpoint. 2. If the display looks corrupted, press the iBox Computer Reset button.
Learn Switch Timed Out Fault, LEARN SW TIMED OUT
Description: When the Learn Switch is ON for more than 15 minutes, the car will shut down.
Car Reaction: The car is not allowed to restart after the current run is completed.
Troubleshooting: <ol style="list-style-type: none"> 1. Turn OFF the iBox Learn switch. 2. If more time is needed in the Learn mode, then turn the Learn switch back ON to reset the fifteen minute timer.
Learn U/DNT1-5 and U/DETS Positions, LEARN U/DTS POSITIONS
Description: The positions for the normal and emergency terminal limit switches have not been learned.
Car Reaction: The elevator can only be run on Inspection or Test modes.
Troubleshooting: Perform the normal and emergency terminal limit switches learn operation (Learn tab on the iView Terminal Switches Configuration screen)
Learn U/DNT1-5 and U/DETS Speeds, LEARN U/DTS SPEEDS
Description: The speeds for the normal and emergency terminal limit switches have not been learned.
Car Reaction: The elevator can only be run on Inspection or Test modes.
Troubleshooting: Perform the normal and emergency terminal limit switches learn operation (Learn tab on the iView Terminal Switches Configuration screen)
Learning empty load values, LEARNING EMPTY LOAD
Description: Empty car load learn calibration has been initiated.
Car Reaction: Car will start load learn process.
Learning full load values, LEARNING FULL LOAD
Description: Full car load learn calibration has been initiated.
Car Reaction: Car will start load learn process.

Table 6.3 iControl Messages

iControl Messages
Light Load Antinuisance
Description: Light load anti- nuisance operation. The load in the car is less than the programmed Light Load Threshold value.
Car Reaction: Under these conditions, an anti- nuisance feature (if enabled) will limit the number of car calls registered. Should the number of registered car calls exceed the programmed limit, all car calls will be canceled.
Troubleshooting: <ol style="list-style-type: none"> 1. If this message appears to be displayed in error, verify the programmed "Light Load Threshold" value. (Adjust if needed on the Load Weigher Configuration screen.) 2. Verify the user-defined number of car calls allowed if the car load is less than the Light Load Threshold. Please refer to "Car Operation - Passenger Tab" on page 9-37. 3. Evaluate whether or not the load in the car is less than the Light Load Threshold value. Calibrate the load weigher if necessary. 4. For discrete input load weighers, check the Light Load input shown on the job prints.
Limit Switches Checksum Fault, LIMIT SW CHKSUM FAULT
Description: The learned ETS and NTS limit switch speed values have an Invalid Checksum in nonvolatile memory. A checksum is a means of validating data that has been stored in nonvolatile memory. An invalid checksum means that the data stored may not be reliable.
Car Reaction: Emergency stop: Motor contactor and brake contactor immediately dropped.
Troubleshooting: <ol style="list-style-type: none"> 1. Relearn the Hoistway limit switches. 2. Use the Default option on the Terminal Switch learning screen.
Limit Switches Learn Fault, LIMIT SW LEARN FAULT
Description: Safety Processor A experienced a failure when storing learned limit switch speed values to non-volatile memory.
Car Reaction: Emergency stop: Motor contactor and brake contactor immediately dropped.
Troubleshooting: <ol style="list-style-type: none"> 1. Press the Fault Reset button to clear the fault. 2. If problem persists, consult MCE Technical Support.
Load calibration on, LOAD CALIBRATION ON
Description: Load learn calibration has been initiated.
Car Reaction: Car will start load learn process.
Load learn process activated. See Load Calibration On.
Load learn process deactivated
Lobby Peak Mode, LOBBY PEAK MODE
Description: The elevator is operating in lobby peak mode, favoring traffic coming from the lobby.
Loss of Position or Speed Indicators, LOSS OF POS/SPD IND
Description: The speed feedback signal used to compare with the position feedback signal is not being seen properly or is not properly calibrated. This can be caused by a loss of traction.
Car Reaction: Emergency Stop. Latched fault.
Troubleshooting: <ol style="list-style-type: none"> 1. On the iView oscilloscope (or a DVM connected between STP1 and STP2), compare Pattern Command and Speed Feedback readouts. They must match within 0.050 VDC while the car is running at steady state speed. If not, adjust the TACH ADJ trimpot. Please refer to "Verify Pattern Command and Drive Speed Feedback" on page 2-56. 2. Use a hand-held tachometer to verify car speed. If the actual speed does not match commanded speed, adjust motor parameter LF.22. Please refer to "Calibrating Actual Car Speed" on page 2-57. 3. Run the car on inspection and check the speed displayed on the iBox display.

Table 6.3 iControl Messages

iControl Messages
Mac Address Error, MAC ADDRESS ERROR
Description: The iBox has detected that one of its three MAC addresses has been defaulted or set to zero. This could lead to multiple cars having the same MAC address, which will cause network problems.
Car Reaction: None.
Troubleshooting: Remove the iBox front cover. On the iBox OBD select Car > View Factory Data > MAC Addresses. Verify that the MAC addresses displayed on the LCD match the addresses on the barcode stickers on the ICE-IMP board. Make corrections if necessary.
Machine Room Heat Detectors Activated, MR HEAT DETECTORS
Description: The machine room heat detector input is activated. The fire warning light will flash until all heat detectors have been reset. The fire-warning buzzer will sound until the car is shutdown at a floor.
Car Reaction: A car that is parked at a floor will open its doors and shut down. A car in motion will proceed in the current direction to the next available floor where the heat detector is not tripped. If all heat detectors in the current direction are tripped, the car will reverse direction and proceed to the first floor where the heat detector is not tripped. If again all heat detectors are tripped, the car shall proceed to the main fire recall floor unless the car is also on Fire Service, in which case the car will proceed to the appropriate fire recall floor. Once the car is stopped at a floor it shall automatically open its doors and shut down. Then, if the machine room or hoistway heat detectors are active, a signal is provided to disconnect the main power line and activate the sprinklers where available. Please refer to "Car Operation - Heat Detectors" on page 9-86.
Machine Room Heat Detectors Deactivated
Description: The machine room heat detector input is deactivated.
Car Reaction: The car is allowed to run.
Machine Room Stop Switch Open, MR STOP SWITCH OPEN
Description: The machine room stop switch input has dropped.
Car Reaction: Emergency stop if running. The car is not allowed to run until the problem is corrected.
Troubleshooting: 1. Check the Machine Room stop switch on the front panel of the iBox.
Machine Room Inspection Disabled, MR INSP. DISABLED
Description: Machine room inspection operation has been disabled.
Car Reaction: The car cannot be run on machine room inspection operation.
Troubleshooting: 1. Check for any car status that might prevent machine room inspection operation, e.g. earthquake. 2. Check for the Stuck Inspection Input Fault. 3. Check all inspection buttons (Enable, Up, Down) and verify that none are stuck in the ON position.
Machine Room Inspection Enabled
Description: Machine room inspection operation which was previously disabled is now enabled.
Machine Room Inspection Operation, Machine Rm Inspection, Mach Rm Insp
Description: Car placed in Machine Room Inspection operation using the iBox Inspection switch.
Car Reaction: Car begins operating in Inspection mode. If running, the car will make an emergency stop and is taken out of normal service. Under this mode of operation, car can only be moved manually using the iBox Inspection Up and Down switches.
Troubleshooting: 1. Related inputs: MachineRoomInspection: Normally high

Table 6.3 iControl Messages

iControl Messages
Main Floor Smoke Sensor Recall, MAIN FLOOR SMOKE
Description: Recall to the alternate fire floor due to active or latched smoke detector inputs from the main floor.
Car Reaction: Car proceeds to the user-defined alternate fire recall floor. Once at the recall floor, door operation is according to the user-defined door operation under fire recall operation.
Troubleshooting: 1. If in error, inspect the sensor input and connections. 2. Related Inputs: Main floor smoke and fire sensors as indicated on job print drawing(s) -1.
Motion Start Fault, MOTION START FAULT
Description: Car initiated movement but was unable to start for more than ten seconds.
Car Reaction: Emergency stop: Motor contactor and brake contactor immediately dropped.
Troubleshooting: 1. Determine mechanical or other reason car is unable to start.
Motion stopped due to IO toggle test, MOTION STOPPED-IO TST
Description: iBox requested start of motion while a toggle test was being performed.
Car Reaction: None. iBox will resend request.
Troubleshooting: NA
Motor Contactor Driver Proofing Fault, MOTR CNTR DRV PRF FLT
Description: Fault signal for motor contactor driver proofing circuits.
Car Reaction: None
Troubleshooting: 1. Verify motor contactor driver proofing circuits. 2. Check the coil of the motor contactor.
Motor Contactor Proofing Fault, MOTOR CNTR PROOF FLT
Description: Fault signal for motor contactor proofing circuits.
Car Reaction: None
Troubleshooting: 1. Verify motor contactor proofing circuits.
Motor Field Forcing Timed Out, MF FORCING TIMED OUT
Description: DC motors only. The motor field was being forced for over 1 minute.
Car Reaction: Stop the run. Restart.
Troubleshooting: 1. The motor field starts forcing if there is a demand and the doors are closing. Check that the doors are not obstructed and/or that passengers are not holding the doors open past the 1 minute limit.
Motor Limit Protection Timer Elapsed, MOTOR LMT TIMED OUT 2
Description: A fault is generated is the system requests movement for more than ten minutes but no movement is detected.
Car Reaction: Currently for informational purposes only.
Motor Limit Timed Out, MOTOR LIMIT TIMED OUT
Description: Generated if no other fault has been generated and the system has attempted to move the car for three minutes with no movement detected or has detected only minimum movement for ten minutes.
Car Reaction: Emergency stop: Motor contactor and brake contactor immediately dropped. Cancel all calls.
Troubleshooting: 1. Check that Pattern Scaling is not set to 0.0. 2. Check Contract Speed is correctly set. 3. Check pattern voltage to drive (0 - 10V) with meter.

Table 6.3 iControl Messages

iControl Messages
Nudging Front, NUDGING FRONT
Description: This event is logged when front door nudging operation is invoked.
Car Reaction: Front doors start closing at reduced speed and torque.
Nudging Operation
Description: The doors are operating in Nudging mode. (Passenger operation).
Nudging Rear, NUDGING REAR
Description: This event is logged when rear door nudging operation is invoked.
Car Reaction: Rear doors start closing at reduced speed and torque.
Other Cars Alternate Fire Sensor Recall, OTHER CARS ALT FIRE
Description: Alternate fire recall due to active or latched smoke detector input(s) from the hoistway or machine room of other cars in the system.
Car Reaction: Car proceeds to the user-defined alternate fire recall floor. Once at the recall floor, door operation is according to the user-defined door operation under fire recall operation.
Troubleshooting: 1. If in error, inspect the sensors, inputs, and connections. 2. Related Inputs: Other Cars Alt Recall sensor inputs as indicated on job prints.
Other Cars Main Fire Sensor Recall, OTHER CARS MAIN FIRE
Description: Main fire recall due to active or latched smoke detector input(s) from the hoistway or machine room of other cars in the system.
Car Reaction: Car proceeds to the user-defined main fire recall floor. Once at the recall floor, door operation is according to the user-defined door operation under fire recall operation.
Troubleshooting: 1. If in error, inspect the sensors, inputs, and connections. 2. Related Inputs: Other Cars Main Recall sensor inputs as indicated on job prints.
PARAM CHNG-RESET CAR, see Global Parameter Update, Reset Controller
Passenger Operation, Passenger. Normal operation status message.
Photo Eye Antinuisance
Description: This event is logged when car calls are canceled due to a user-defined number of car calls being registered without interruption of the photo eye device.
Car Reaction: All car calls are cancelled.
Troubleshooting: 1. Check the user defined options related to the operation. (iView/Car Operation/Passenger/Anti Nuisance.) 2. Check the photo eye device and related inputs.
Position Cartop Offset Fault, POSTN CARTP OFFST FLT
Description: Each time the car stops, it obtains position information from the cartop position encoder. If the reported position varies from the position last reported at this location by more than two feet, this fault is generated.
Car Reaction: Emergency stop. Motor and brake contactors immediately dropped.
Troubleshooting: Perform a Terminal Synchronization (Pattern Configuration screen>Common tab>Position Synchronization.
Position Location Error Fault, POSTN LCTN ERROR FLT
Description: If the difference between the learned position of a floor (magnet) and the currently indicated position of that floor (magnet) is greater than 2 feet, this fault is generated.
Car Reaction: Car will perform a terminal synchronization.
Troubleshooting: 1. Check that the iLand landing system is properly installed and adjusted. (Refer to Section 3 of this guide.)

Table 6.3 iControl Messages

iControl Messages
Position Quadrature Fault, POSITION QUAD FAULT
Description: The quadrature signal from iLand is not being detected (one or both streams). When moving above 30 fpm, the system expects to see proper transitions on both quadrature signals. This fault may be bypassed on the Diagnostics > Fault Bypass tab.
Car Reaction: Emergency stop.
Troubleshooting: <ol style="list-style-type: none"> 1. Verify that both quadrature channels are arriving at the iBox. 2. On the Hoistway screen, verify that the absolute position increments when moving up and decrements when moving down (on inspection). If absolute position does not change, there may be a problem with the iBox.
Position Quadrature Reversed Fault, POSITN QUAD RVRSD FLT
Description: The arrival sequence of the quadrature pulse streams indicates travel in the opposite direction of that requested by the system.
Car Reaction: None.
Troubleshooting: <ol style="list-style-type: none"> 1. Verify that the elevator moves in the requested direction. 2. On the Hoistway screen, verify that the cartop position increments when moving up and decrements when moving down (on inspection). 3. On the Hoistway screen, verify that the absolute position increments when moving up and decrements when moving down (on inspection).
Position Speed Deviation Fault, POSITN SPEED DVTN FLT
Description: The safety processor compares the distance travelled reported by the position quadrature with the distance travelled according to motor rotation. If the quadrature reports 48" travelled but the motor reports less than 32" travelled, this fault is generated. This fault may be bypassed on the Diagnostics > Fault Bypass tab.
Car Reaction: Emergency stop: Motor contactor and brake contactor immediately dropped.
Troubleshooting: <ol style="list-style-type: none"> 1. Check velocity feedback from drive. 2. Check that Pattern Configuration/General tab Position Encoder Resolution is set to 256. 3. Check calibration of speed feedback signal.
Position Speed Threshold Fault, POSTN SPD THRSHL D FLT
Description: The quadrature synthesized speed exceeds 115% of contract speed. This fault may be bypassed on the Diagnostics > Fault Bypass tab.
Car Reaction: Emergency stop: Motor contactor and brake contactor immediately dropped.
Troubleshooting: <ol style="list-style-type: none"> 1. On the iView oscilloscope, compare Pattern Command and Speed Feedback to see that they match. 2. Use a hand-held tachometer to verify car speed. 3. Run the car on inspection and check the speed displayed on the iBox display. 4. For SCR drives, verify that the programmed running motor field is close to the actual motor field value when running at contract speed. If the value is higher, the system will have to weaken the motor field as the elevator reaches contract speed. If the motor field is very inductive, this may cause an overshoot. If the value is too low, excessive current may flow through the armature. Note that load will affect this value. Running in the up direction with a full load in the car will yield the worst-case scenario. For an empty elevator, running in the down direction produces the worst-case scenario (the value will be higher than for the fully loaded car.) 5. For highly inductive motor fields, begin motor field weakening earlier and end motor field weakening earlier. If the begin weakening percentage is too low, poor control will result when the elevator is approaching the destination floor (spotting). If this is the case, reduce the end weaken percentage without modifying (by much) the begin weakening percentage. Generally, begin is recommended around 50% while end is recommended around 90% for normal motor fields. 6. Reduce high roll jerk.

Table 6.3 iControl Messages

iControl Messages
Position Synchronization Fault
Description: The system was not able to read the position correction value stored in battery backed RAM when the controller powered up. This fault usually results in a floor sensor fault or a position location fault.
Car Reaction: None.
Troubleshooting: 1. Verify iBox battery connection and charge (lower left side of ICE-IMP board - iBox cover removed). Battery type: 1/2 AA, 3.6V Lithium. Manufacturer: SAFT, part # LS14250. MCE part # 30-05-0001.
Position Synchronization Required at Floor, POSITION SYNC-FLOOR
Description: The elevator needs to verify position by crossing a door zone sensor.
Car Reaction: Cancel all existing calls, synchronize to floor.
Position Synchronization Required at Terminal, POSITION SYNC-TERMINAL
Description: The elevator does not know where it is. It needs to locate a terminal door zone sensor to establish position.
Car Reaction: Cancel all existing calls, synchronize to terminal.
Position Synchronized at Floor
Description: The elevator has completed synchronizing its position using a door zone sensor. See Position Synchronization Required at Floor.
Car Reaction: Return to normal service.
Position Synchronized at Terminal
Description: The elevator has completed synchronizing its position using a terminal door zone sensor. See Position Synchronization Required at Terminal.
Car Reaction: Return to normal operation.
Power Transfer Input Activated, Power Transfer, POWER TRANSFER
Description: Power transfer input activated. Power is being transferred from the emergency generator to commercial service.
Car Reaction: Cancel existing calls. Stop at next floor and open doors.
Troubleshooting: Check the Power Transfer input.
Power Transfer Input Deactivated
Power Up Position Synchronization Required at Terminal
Description: Position synchronization at a terminal landing required after power-up/reset. Terminal synchronization after power-up will occur if the elevator was required to synchronize before power was lost or the controller was reset, or if synchronization information in battery backed SRAM is invalid.
Car Reaction: The elevator will synchronize at a terminal landing.
Troubleshooting: 1. Battery may need to be changed. 2. Check for faulty SRAM. 3. Check for SRAM not correctly inserted in socket. 4. Check for faulty iBox.

Table 6.3 iControl Messages

iControl Messages
Pre-start Door Lock Fault
Description: Once the decision to move the elevator has been made, three acknowledgments (motion start, door lock and drive start) must be received before physical movement is allowed. However, if the system is so configured, pre-start sequencing will begin while the doors are closing. If the door lock acknowledgement is not received within 15 seconds (after the pre-start sequence is begun), this fault is generated.
Car Reaction: The pre-start sequence will stop and the sequence will repeat. If the fault persists, an excessive restarts fault will occur.
Troubleshooting: <ol style="list-style-type: none"> 1. Verify that the doors (front and/or rear) become locked within the prescribed time. 2. Verify, via the iView Diagnostics - Motion tab, that the system sees the doors closing and becoming locked within the prescribed time. The information reflects front and rear door status combined. 3. Verify, via the Diagnostics - Car Operation - Front/Rear tabs, that the system sees the front/rear doors closing and becoming locked within the prescribed time.
Primary Fire Switch Bypass, PRI FIRE SWITCH BYP
Description: The primary fire switch is in the Bypass position.
Car Reaction: According to selected Fire Code.
Troubleshooting: <ol style="list-style-type: none"> 1. Check the primary fire recall switch inputs.
Primary Fire Switch On, PRI FIRE SWITCH ON
Description: The primary fire switch is in the On position.
Car Reaction: The car will recall to the Main fire recall floor, position its doors as directed on the Car Operation/Fire/Modify/Fire Recall screen, and wait for activation of the in-car firefighter switch.
Troubleshooting: If in error, check the Primary Fire Recall Switch input.
QPRAM Device Error, QPRAM DEVICE ERROR
Description: Safety Processor A problem writing to QPRAM device.
Car Reaction: Emergency stop: Motor contactor and brake contactor immediately dropped.
Troubleshooting: <ol style="list-style-type: none"> 1. Replace QPRAM on Safety Processor A. Contact MCE.
Rear Door Close Fault, REAR DOOR CLOSE FAULT
Description: One or more rear door failures to close have been detected. The controller will attempt to close the doors as defined by user parameters (door close protection timer and number of attempts) before declaring this fault. iView Car Operation/Doors tab.
Car Reaction: The doors will reopen fully. All car calls are canceled and car removes itself from hall call service (hall calls assigned to this car are canceled or reassigned to other cars if available). Doors may be closed using constant pressure on the rear door close button.
Troubleshooting: <ol style="list-style-type: none"> 1. Door closed status is determined by the rear door close limit and by the rear door position monitor contact if applicable. 2. Check the wiring of these signals. 3. Check the door close protection timer and number of closing attempts on the Operation/Doors tab.

Table 6.3 iControl Messages

iControl Messages
Rear Door Close Fault Recovery Failure, R DR CLS FLT REC FAIL
Description: The Door Close Fault Recovery timer starts when a Door Close Fault is generated. When the timer expires, the Door Close Fault is cleared to allow the doors to again attempt to close (see Rear Door Close Fault). This is repeated the number of times specified by the Door Close Fault Recovery Attempts parameter. If the doors have failed to close when the number of attempts equals the recovery attempts parameter setting, the Rear Door Close Fault Recovery Failure is generated.
Car Reaction: The car is not allowed to run until a mode change is detected or the doors are successfully closed via constant pressure on the Door Close Button.
Troubleshooting: <ol style="list-style-type: none"> 1. Door closed status is determined by the rear door close limit and by the rear door position monitor contact if applicable. Check the wiring of these signals. 2. Check the door close protection timer and number of closing attempts on the Car Operation - Doors tab.
Rear Door Close Time-out
Description: A failure of the rear door to close has been detected. The controller will attempt to close the doors for a period of time defined by the Closing protection timer parameter (Door Motor Protection Timers). If the timer elapses prior to the doors closing fully, this event is generated.
Car Reaction: Doors reopen fully and again attempt to close.
Troubleshooting: <ol style="list-style-type: none"> 1. Door closed status is determined by the rear door close limit and by the rear door position monitor contact if applicable. 2. Check the wiring of these signals. 3. Check the Closing protection timer (iView Car Operation Configuration/Doors Tab/General Tab/Door Motor Protection Timers).
Rear Doors Stopped, REAR DOORS STOPPED
Description: The Door Stop button or Emergency Stop switch was activated causing the doors to be prevented from moving.
Car Reaction: The car is not allowed to move unless the doors are fully closed.
Troubleshooting: This condition can be cleared by activation of the Door Open button, Door Close button or if the car goes into Inspection or Fire Service mode, provided that the Door Stop input is off.
Rear Door Contact Fault, REAR DOOR CONTACT FLT
Description: A faulty rear door contact (gate switch, door lock) has been detected. This is detected when the doors are in their fully open position and either the gate switch contact is closed or the doors appear to be locked.
Car Reaction: All car calls are canceled and the car removes itself from hall call service. The rear doors are not allowed to close and the car is not allowed to run.
Troubleshooting: <ol style="list-style-type: none"> 1. Check the rear door gate switch and door lock contact at the floor at which the car is located. 2. Check associated wiring for these signals.
Rear Door Open Button Bypassed, REAR DOB BYPASSED
Description: The rear door open button has been continuously activated for a user-defined time and is now bypassed according to the user defined setting. (iView/Car Operation/Doors/Advanced.)
Car Reaction: The rear door open button is rendered inoperative.
Troubleshooting: <ol style="list-style-type: none"> 1. Check the corresponding input: Rear Door - Open Button (Normally low). 2. The operation of the door open button can also be restored by setting the Door open button bypass option to off (unchecked) (Car Operation Configuration/Doors Tab/Advanced dialog).

Table 6.3 iControl Messages

iControl Messages
Rear Door Open Fault, REAR DOOR OPEN FAULT
Description: One or more rear door failures to open fully have been detected. After repeated attempts to open the door (as specified by user parameters), a door open failure is declared. The amount of time allowed for the door to open and the number of attempts made are user parameters. iView Car Operation/Doors tab, plus Advanced dialog.
Car Reaction: The door stalls at its last position. Car calls are canceled and the car removes itself from hall call service (hall calls assigned to this car are canceled or reassigned to other cars if available). Doors may be moved via constant pressure on the door open and door close buttons.
Troubleshooting: <ol style="list-style-type: none"> 1. The door open status is determined by the rear door open limit status. 2. Check the wiring of this signal. 3. Check the door open protection timer and number of open attempts on the Operation screen Doors tab and associated Advanced dialog.
Rear Door Open Time-out
Description: A failure of the rear door to open has been detected. The controller will attempt to open the doors for a period of time defined by the Opening protection timer parameter (Door Motor Protection Timers). If the timer elapses prior to the doors opening fully, this event is generated.
Car Reaction: The door open cycle is halted and the door is allowed to reclose. If so configured, repeated attempts will be made to open the door. Otherwise, the car is allowed to leave the landing once the doors are closed.
Troubleshooting: <ol style="list-style-type: none"> 1. Door open status is determined by the rear door open limit and by the rear door position monitor contact if applicable. 2. Check the wiring of these signals. 3. Check the Opening protection timer (iView Car Operation Configuration/Doors Tab/General Tab/Door Motor Protection Timers).
Rear Doors Stopped, REAR DOORS STOPPED
Description: While the rear doors were opening or closing, the Door Stop button or Emergency Stop switch was activated causing the doors to stop.
Car Reaction: The car is not allowed to move unless the doors are fully closed.
Troubleshooting: This condition can be cleared by activation of the Door Open button, Door Close button or by changing to a different mode of operation, e.g. Inspection.
Rear DPM Open - GS Closed, R DPM OPEN-GS CLOSED
Description: The rear door position monitoring contact is open while the gate switch is closed.
Car Reaction: None.
Troubleshooting: Check the rear door position monitoring contact, gate switch and all related circuitry.
Rear Hall Door Open Button Bypassed, REAR HALL DOB BYP
Description: The rear hall door open button has been continuously activated for a user-defined time (Door open bypass timer) and is now bypassed in accordance with the user-defined setting (Car Operation Configuration/Doors tab/Advanced dialog).
Car Reaction: The rear hall door open button is rendered inoperative.
Troubleshooting: <ol style="list-style-type: none"> 1. Check the corresponding input, Rear Door - Hall Door Open Button: Normally low. 2. The operation of the hall door open button can also be restored by setting the Door open button bypass option to off (unchecked) (Car Operation Configuration/Doors tab/Advanced dialog).

Table 6.3 iControl Messages

iControl Messages
Rear Photo Eye Bypassed, REAR PHOTO EYE BYP
Description: The rear photo eye device has been continuously activated for a user-defined time and is now bypassed in accordance to the user-defined setting. (iView/Car Operation/Passenger/Anti Nuisance.)
Car Reaction: The rear photo eye device is rendered inoperative.
Troubleshooting: 1. To restore the operation of the photo eye device, check the corresponding input. 2. Related inputs: PhotoEyeRear: Normally low
Rear Photo Eye Failure, REAR PHOTO EYE FAIL
Description: This event is logged when the photo eye is continuously activated for a predetermined time (4 seconds) while the rear doors are fully closed.
Car Reaction: The rear photo eye is rendered inoperative.
Troubleshooting: 1. Check for abnormal blockage or failure of the rear optical device. 2. Related inputs: RearPhotoEye: Normally low
Rear Safe Edge Bypassed, REAR SAFE EDGE BYP
Description: The rear door safe edge has been continuously activated for a user-defined time and is now bypassed according to the user-defined setting. (iView/Car Operation/Common/Door Device Bypass Timers.)
Car Reaction: The rear safe edge is rendered inoperative.
Troubleshooting: 1. Check the state of the rear safe edge input. 2. Related inputs: SafeEdgeRear: Normally low
Rear Safe Edge Failure, REAR SAFE EDGE FAIL
Description: This event is logged when the rear door safe edge is continuously activated for a predetermined time (4 seconds) while the rear doors are fully closed.
Car Reaction: The rear door safe edge is rendered inoperative.
Troubleshooting: 1. Check for abnormal blockage or failure of the rear door mechanical reopening device. 2. Related inputs: RearSafeEdge: Normally low
Receive Sys Params
Description: Indicates that this controller is receiving system parameters from the Central or Local / Dispatcher. (DO NOT RESET THE CONTROLLER).
Restricted, RESTRICTED
Description: Indicates that this controller has been shipped with Restricted Mode enabled. The controller will run in all modes of operation, but will not accept hall call assignments. Restricted mode can be terminated at any time by entering the Restricted Mode Key as described in document 42-IS-0144, <i>Restricted Mode Instruction for iControl Users</i> . Obtain the Restricted Mode Key by calling MCE's Credit Department at (916) 463-9582. When calling, please provide the controller's job number and car identifier.
R DR CLS FLT REC FAIL. See Rear Door Close Fault Recovery Failure

Table 6.3 iControl Messages

iControl Messages
Retiring Cam Door Lock Fault Activated, Retiring Cam Door Lock Fault, RETIRING CAM DLK FLT
Description: The door locks have failed to make up within a pre-determined user-adjustable time after a user adjustable number of attempts to lock the doors. This fault is detected on cars equipped with a retiring cam door lock mechanism.
Car Reaction: Car is taken out of service and doors re-open fully. The doors can be closed with constant pressure on the door close button.
Troubleshooting: <ol style="list-style-type: none"> 1. Check the door locks and the retiring cam circuitry. 2. Verify that the related user-defined parameters are correct. 3. This fault is cleared by any mode of operation change or if the doors are closed with constant pressure on the door closed button.
Retiring Cam Door Lock Fault Deactivated. See Retiring Cam Door Lock Fault Activated
Retiring Cam Protection Fault Activated, Retiring Cam Protection Fault, RET CAM PROTECTIN FLT
Description: The retiring cam output has been activated for a pre-determined user-adjustable time after the doors have successfully been locked. This fault is monitored in the event the car fails to reach its destination.
Car Reaction: Emergency stop if the car is traveling when the fault is detected. The car is taken out of service. If the car is at a landing, the doors shall re-open fully.
Troubleshooting: <ol style="list-style-type: none"> 1. Check the door locks and the retiring cam circuitry. 2. Verify that the related parameters are correct. 3. This fault is cleared by any mode of operation change or by the iBox Fault Reset button.
Retiring Cam Protection Fault Deactivated. See Retiring Cam Protection Fault Activated
Sabbath Operation Activated, Sabbath Operation, SABBATH OPERATION. The elevator is operating in Sabbath mode initiated by a software command, switched input or timer. Sabbath mode allows the elevator to operate, serving the building without requiring buttons to be pressed for hall calls or car calls. Car behavior is determined by parameters located on the Car Operation Configuration > Sabbath tab.
Sabbath Operation Deactivated. See Sabbath Operation Activated.
Safety A Contract Overspeed Fault, SPA COS FAULT
Description: The car has exceeded the Contract Overspeed setting (iView, Safety Configuration screen). This fault may be bypassed on the Diagnostics > Fault Bypass tab.
Car Reaction: Emergency Stop: Motor contactor and brake contactor immediately dropped.
Troubleshooting: <ol style="list-style-type: none"> 1. The fault will automatically clear 5 seconds after the car stops. The car is then allowed to run again. 2. Check the contract overspeed parameter for proper setting (iView/Safety Configuration/General).
Safety A DETS Level 2 Speed Fault, SPA DETS L2 SPEED FLT
Description: The car contacted the Down Emergency Terminal Switch while traveling at over 95% of contract speed. This fault may be bypassed on the Diagnostics > Fault Bypass tab.
Car Reaction: Emergency stop: Motor contactor and brake contactor immediately dropped.
Troubleshooting: <ol style="list-style-type: none"> 1. The fault will automatically clear 5 seconds after the car stops. The car is then allowed to run again. 2. Check for the proper positioning of the DETS switch in the hoistway.

Table 6.3 iControl Messages

iControl Messages
Safety A IMP Configuration Mismatch
Description: The parameters saved in the Safety system do not match the values saved in the main processor. When Safety screen parameters are changed, this message appears after the Send button is pressed. Complete a Safety learn operation as directed on the iView Safety Configuration screen to learn the new safety configuration.
Car Reaction: Car will not run.
Troubleshooting: <ol style="list-style-type: none"> Using iView, check the values programmed under the Safety Configuration screen. Verify that they are correct. Download correct values to the Safety system by executing the learn process from the Safety screen.
Safety A Inspection Leveling Overspeed Fault, SPA LOS FAULT
Description: The car exceeded the leveling overspeed limit (detected by safety processor A). This fault may be bypassed on the Diagnostics > Fault Bypass tab.
Car Reaction: Emergency stop: Motor contactor and brake contactor immediately dropped.
Troubleshooting: <ol style="list-style-type: none"> The fault will automatically clear 5 seconds after the car stops. The car is then allowed to move again. Check the leveling overspeed parameter for proper setting (iView/Safety Config/General).
Safety A Inspection Overspeed Fault, SPA IOS FAULT
Description: The car has exceeded the inspection overspeed limit of 150 fpm (detected by safety processor A). This fault may be bypassed on the Diagnostics > Fault Bypass tab.
Car Reaction: Emergency stop: Motor contactor and brake contactor immediately dropped.
Troubleshooting: <ol style="list-style-type: none"> The fault will automatically clear 5 seconds after the car stops. The car is then allowed to move again.
Safety A SIB Device Fault, SPA SIB DEVICE FAULT
Description: Safety Processor A has a problem writing Safety Ice Bus.
Car Reaction: Emergency stop: Motor contactor and brake contactor immediately dropped.
Troubleshooting: <ol style="list-style-type: none"> Replace iBox. SAF Board damaged. Contact MCE.
Safety A SIB Device Fault Off (See: Safety A SIB Device Fault)
Safety A UETS Level 2 Speed Fault, SPA UETS L2 SPD FLT
Description: The car contacted the Up Emergency Terminal Switch while traveling at over 95% of contract speed. This fault may be bypassed on the Diagnostics > Fault Bypass tab.
Car Reaction: Emergency stop: Motor contactor and brake contactor immediately dropped.
Troubleshooting: <ol style="list-style-type: none"> The fault will automatically clear 5 seconds after the car stops. The car is then allowed to run again. Check for the proper positioning of the UETS switch in the hoistway.
Safety A Unintended Motion Fault, SPA UNTD MOTION FLT
Description: Safety processor A has detected that both hoistway doors and car gate doors were open as the car moved away from the floor without a command from the iControl main processor (IMP board) to move.
Car Reaction: Emergency stop: Motor contactor and brake contactor immediately dropped. If applicable, the rope brake drops.
Troubleshooting: <ol style="list-style-type: none"> Check for proper door operation and control. Close the hoistway doors and close the car gate. Press the Fault Reset button. Test.

Table 6.3 iControl Messages

iControl Messages
Safety B Contract Overspeed Fault, SPB COS FAULT
Description: The car has exceeded the Contract Overspeed setting. This fault may be bypassed on the Diagnostics > Fault Bypass tab.
Car Reaction: Emergency stop: Motor contactor and brake contactor immediately dropped.
Troubleshooting: 1. The fault will automatically clear 5 seconds after the car stops. The car is then allowed to run again. 2. Check the contract overspeed parameter for proper setting. (iView/Safety Config/General)
Safety B DETS Level 2 Speed Fault, SPB DETS L2 SPEED FLT
Description: The car contacted the Down Emergency Terminal Switch while traveling at over 95% of contract speed. This fault may be bypassed on the Diagnostics > Fault Bypass tab.
Car Reaction: Emergency stop: Motor contactor and brake contactor immediately dropped.
Troubleshooting: 1. The fault will automatically clear 5 seconds after the car stops. The car is then allowed to run again. 2. Check for the proper positioning of the DETS switch in the hoistway.
Safety B Fault Bypass Switch Timed Out
Description: Indicates that a fault bypass has timed out. (Bypasses are allowed for 15 minutes with the iBox Fault/Function Bypass switch in the ON position.) On Inspection mode, this fault is bypassed indefinitely.
Car Reaction: Emergency stop: Motor contactor and brake contactor immediately dropped.
Troubleshooting: 1. To clear this fault, place the Fault/Function Bypass switch to the OFF position.
Safety B Inspection Leveling Overspeed Fault, SPB LOS FAULT
Description: The car exceeded the leveling overspeed limit (detected by safety processor B). This fault may be bypassed on the Diagnostics > Fault Bypass tab.
Car Reaction: Emergency stop: Motor contactor and brake contactor immediately dropped.
Troubleshooting: 1. The fault will automatically clear 5 seconds after the car stops. The car is then allowed to move again. 2. Check the leveling overspeed parameter for proper setting (iView/Safety Config/General).
Safety B Inspection Overspeed Fault, SPB IOS FAULT
Description: The car has exceeded the inspection overspeed limit of 150 fpm (detected by safety processor B).
Car Reaction: Emergency stop: Motor contactor and brake contactor immediately dropped.
Troubleshooting: 1. The fault will automatically clear 5 seconds after the car stops. The car is then allowed to move again.
Safety B SIB Device Fault, SPB SIB DEVICE FAULT
Description: Safety Processor B has a problem writing Safety Ice Bus.
Car Reaction: Emergency stop: Motor contactor and brake contactor immediately dropped.
Troubleshooting: 1. Replace iBox. SAF Board damaged. Contact MCE.
Safety B SIB Device Fault Off (See: Safety B SIB Device Fault)
Safety B Safety Bypass Jumper Timed Out
Description: Safety Processor B has detected that the Safety Bypass Jumper has been on for more than 15 minutes.
Car Reaction: The car will not be allowed to restart after the end of the current run.
Troubleshooting: 1. Remove the iBox Safety Bypass Jumper. 2. If more time is needed in the Safety Bypass mode, then reinstall Safety Bypass Jumper and the 15 minute timer will restart.

Table 6.3 iControl Messages

iControl Messages
Safety B UETS Level 2 Speed Fault, SPB UETS L2 SPD FLT
Description: The car contacted the Up Emergency Terminal Switch while traveling at over 95% of contract speed. This fault may be bypassed on the Diagnostics > Fault Bypass tab.
Car Reaction: Emergency stop: Motor contactor and brake contactor immediately dropped.
Troubleshooting: <ol style="list-style-type: none"> 1. The fault will automatically clear 5 seconds after the car stops. The car is then allowed to run again. 2. Check for the proper positioning of the UETS switch in the hoistway.
Safety B Unintended Motion Fault, SPB UNTD MOTION FLT
Description: Safety processor B has detected that both hoistway doors and car gate doors were open as the car moved away from the floor without a command from the iControl main processor (IMP board) to move.
Car Reaction: Emergency stop: Motor contactor and brake contactor immediately dropped. If applicable, the rope brake drops.
Troubleshooting: <ol style="list-style-type: none"> 1. Check for proper door operation and control. 2. Close the hoistway doors and close the car gate. 3. Press the Fault Reset button. Test.
Safety Bypass Jumper On
Description: Indicates that the Safety Bypass Jumper is in place.
Safety Bypass Jumper Timed Out, SFTY BYP JMPR TMD OUT
Description: Safety Processor A has detected that the Safety Bypass Jumper has been on for more than 15 minutes.
Car Reaction: The car will not be allowed to restart after the end of the current run.
Troubleshooting: <ol style="list-style-type: none"> 1. Remove the iBox Safety Bypass Jumper. 2. If more time is needed in the Safety Bypass mode, then reinstall Safety Bypass Jumper and the 15 minute timer will restart.
Safety C String Open, SAFETY C STRING OPEN
Description: The input has dropped. Input does not come on when bypassed, but the bypass will allow it to run on Test and Machine Room Inspection.
Car Reaction: Emergency stop if running. The car is not allowed to run until the problem is corrected.
Troubleshooting: <ol style="list-style-type: none"> 1. Check the car safety string elements and finally the actual input to the iBox.
Safety C String Open Off (See: Safety C String Open)
Safety Configuration Checksum Fault, SFTY CONFIG CHKSM FLT
Description: Safety configuration parameters stored in nonvolatile memory are corrupt or missing.
Car Reaction: The car is not allowed to move.
Troubleshooting: <ol style="list-style-type: none"> 1. Learn the Safety Configuration. Please refer to "Setup - Safety - Configuration Tab" on page 9-147.
Safety Configuration Learn Fault, SFTY CONFIG LEARN FLT
Description: Safety Processor A had a failure when storing configuration values to nonvolatile memory.
Car Reaction: Car will not run until fault is cleared.
Troubleshooting: <ol style="list-style-type: none"> 1. Make sure the car is on Machine Room Inspection before learning the safety configuration. 2. Check that the installed safety configuration matches the selections on the Safety Configuration screen and that no bypasses are in place. 3. Repeat the learn process. Please refer to "Setup - Safety - Configuration Tab" on page 9-147. 4. If unsuccessful, contact MCE Technical Support. (Possible iBox failure.)

Table 6.3 iControl Messages

iControl Messages
Safety Configuration Mismatch, SFTY CONFIG MISMATCH
Description: The parameters saved in the Safety system do not match the values saved in the main processor.
Car Reaction: Car will not run.
Troubleshooting: <ol style="list-style-type: none"> Using iView, check the values programmed under the Safety Configuration screen. Verify that they are correct. Download correct values to the Safety system by executing the learn process from the Safety tab. Please refer to "Setup - Safety - Configuration Tab" on page 9-147.
Safety Configuration Inventory Cross Check Fault, SFTY VCTR XCHK FLT
Description: The safety-related boards in the controller do not match the learned configuration.
Car Reaction: The car is not allowed to move.
Troubleshooting: <ol style="list-style-type: none"> Verify safety bus inventory against safety configuration. If changes are made, relearn the safety configurator. Please refer to "Setup - Safety - Configuration Tab" on page 9-147. Re-learn the board complement (inventory). Please refer to "Setup - Safety - Inventory Tab" on page 9-150.
Safety H String Open, SAFETY H STRING OPEN
Description: The input has dropped. Input does not come on when bypassed, but the bypass will allow it to run on Test and Machine Room Inspection.
Car Reaction: Emergency stop if running. The car is not allowed to run until the problem is corrected.
Troubleshooting: <ol style="list-style-type: none"> Check the car safety string elements and finally the actual input to the iBox.
Safety H String Open Off (See: Safety H String Open)
Safety Inventory Checksum Fault, SFTY INVTRY CHKSUM FLT
Description: The Safety Ice bus board inventory stored in nonvolatile memory is corrupt or missing.
Car Reaction: The car will not run.
Troubleshooting: <ol style="list-style-type: none"> Relearn the inventory of boards using the Learn operation on the Setup > Safety > Inventory tab. Reset the fault (press the iBox FAULT RESET button).
Safety Inventory Comparison Fault, SFTY INVTRY COMPARE FLT
Description: The Safety boards attached to the iBox do not match the safety board inventory kept in the safety system.
Car Reaction: The car will not run.
Troubleshooting: <ol style="list-style-type: none"> Relearn the inventory of boards using the Learn operation on the Setup > Safety > Inventory tab. Reset the fault (press the iBox FAULT RESET button).
Safety Inventory Creation Fault, SFTY INVTRY CREATION FLT
Description: During a relearn of the Safety board inventory, the safety system had a problem creating a list of boards in non-volatile storage.
Car Reaction: Car will not run.
Troubleshooting: <ol style="list-style-type: none"> Relearn the inventory of boards using the Learn operation on the Setup > Safety > Inventory tab. Reset the fault (press the iBox FAULT RESET button). If the fault does not clear, cycle power to the controller. Repeat the first two steps if the fault reoccurs. If the previous steps are unsuccessful, iBox replacement may be indicated.

Table 6.3 iControl Messages

iControl Messages
Safety Inventory Learn Fault, SFTY INVTRY LEARN FLT
Description: Safety Processor A failed to store inventory values to nonvolatile memory.
Car Reaction: None
Troubleshooting: <ol style="list-style-type: none"> 1. Relearn the inventory of boards using the Learn operation on the Setup > Safety > Inventory tab. 2. Reset the fault (press the iBox FAULT RESET button). 3. If the fault does not clear, cycle power to the controller. Repeat the first two steps if the fault reoccurs. 4. If the previous steps are unsuccessful, iBox replacement may be indicated.
Safety String Open
Description: Contact in safety circuit is open.
Car Reaction: Emergency stop: Motor contactor and brake contactor immediately dropped.
Troubleshooting: <ol style="list-style-type: none"> 1. Refer to the job prints. Verify all safety string switches and wiring. 2. Verify the following have power: SAFC, SAFH, GOV, ESM, and ESC (if the car stop switch bypass is off). Note that SAFC and SAFH can be bypassed by installing the Safety Bypass Jumper on the IRB board if the car needs to be moved off the final limits for example). 3. If a rope gripper is installed and the rope gripper option is selected, check RGOK is equal to 1. 4. If a cartop exit is present and the cartop exit option is selected, check that CTEX input is equal to 1. 5. If Unintended Motion was tripped, clear the Unintended Motion fault. 6. Clear any faults left on the iBox display. 7. When the problem is fixed, the fault will automatically clear after 5 seconds.
Safety String Closed (See: Safety String Open)
SCR AC Phase Fault, SCR AC PHASE FAULT
Description: This fault indicates that the 6 feed wires to the M-contactor at the bottom of the System 12 Drive are incorrectly connected. When incorrectly connected, the 30-degree phase angle between X and Y inputs is lost. DC controls only.
Car Reaction: Emergency Stop.
Troubleshooting: <ol style="list-style-type: none"> 1. Check for a defective or disconnected 32-pin ribbon cable between SCR_LGA board and iBox. 2. Check if the SCR Drive Diagnostic indicators WYE PR, DELTA PR, or 30-Degree PR are ON.
SCR Armature Voltage On, SCR ARM VOLTAGE ON
Description: Indicates presence of a DC voltage between armature terminals A1 and A2 in excess of 0.7VDC before RE relay is enabled. DC controls only.
Car Reaction: Failure prevents a normal run.
Troubleshooting: <ol style="list-style-type: none"> 1. Verify test point TP1 on SCR-LGA board (see Section 8) is 0.0mv when no direction is commanded. Adjust R2 if needed. 2. Check for defective serial cable between iBox and drive. 3. Check SCR-LGA board (see Section 8).

Table 6.3 iControl Messages

iControl Messages
SCR Contactor Fuse Fault, SCR CNTACTR FUSE FLT
Description: Indicates that either the semiconductor fuse has blown or one or more of the 6 contacts within the two contactors has failed. DC controls only.
Car Reaction: Emergency Stop.
Troubleshooting: <ol style="list-style-type: none"> 1. Check secondary wires of drive isolation transformer. 2. Check primary voltage on each of the primary terminals of the drive isolation transformer. 3. Check for harsh motor control, vibration, or humming. 4. Check for motor mechanical defect such as interpole (partially shorted). 5. Set an oscilloscope to 2msec/div, 500mv/div, AC coupling. Verify that the 12 drive pulses have equal amplitudes and periods. 6. Check M1 and M2 contacts. 7. Check semiconductor fuses. (See Section 8.)
SCR Drive Ready Fault, SCR DRIVE READY FAULT
Description: Ready signal from the System 12 SCR Drive is inactive. This signal is inactive when the System 12 Drive detects a fault or is being reset (about 5 seconds). DC controls only.
Car Reaction: The elevator is prevented from moving while this signal is inactive.
Troubleshooting: Check the Event Calendar, Hoistway display or iBox display for active SCR drive faults and follow the recommended troubleshooting for those faults.
SCR Dynamic Brake Fault, SCR DYN BRAKE FAULT
Description: This fault indicates that there is either more than 18-volts across the dynamic braking resistor or the dynamic brake input from the SCR drive is active. DC controls only.
Car Reaction: Emergency Stop.
Troubleshooting: <ol style="list-style-type: none"> 1. If this fault occurs with no other SCR Drive faults in the Event Log, it is likely that a different failure such as an AC Phase Failure has occurred. However, that failure occurred too quickly to be captured. 2. If other SCR drive faults are present, indicates a possible defective dynamic brake SCR or SCR-LG9A) board (see Section 8).
SCR Excessive Armature Current, SCR EXS ARM CURRENT
Description: Armature feedback current exceeded 200% of rated armature current within 250 milliseconds after run enabled. Triggers a Drive Forced fault if encountered 4 times within 7 run attempts. DC controls only.
Car Reaction: Car will not run.
Troubleshooting: <ol style="list-style-type: none"> 1. Run the car on inspection while monitoring armature current versus command current. Verify both values are approximately equal. 2. Check interpole feedback, filter capacitors (SCR page of job prints), any component in the loop feedback from the SCR drive out to the motor and back to the drive. 3. Verify drive header current and voltage. 4. Check serial cable between iBox and drive. 5. Check SCR-LGA board (section 8).
SCR Excessive Current Command, Drive Disabled, SCR EXS CURRENT CMD DD
Description: Current command output greater than 200mV before run enable. DC controls only.
Car Reaction: Car will not run.
Troubleshooting: <ol style="list-style-type: none"> 1. Verify standard control gains (proportional, integral) on drive screens.

Table 6.3 iControl Messages

iControl Messages
SCR Excessive Current Command, Drive Enabled, SCR EXS CURRENT CMD DE
Description: Current command output greater than 7VDC within 300mS after enabling the run enable relay, drive enabled. DC controls only.
Car Reaction: Car will not run.
Troubleshooting: 1. Check serial cable between iBox and drive. 2. Check SCR-LGA board (section 8).
SCR High Temp Fault, SCR HIGH TEMP FAULT
Description: This fault indicates that either the ambient temperature inside the System 12 drive has exceeded 170 degrees F or there is a bad or failing SCR. iControl will attempt to bring the car to the nearest floor before shutting down. The fault clears when the temperature drops below tripping threshold. DC controls only.
Car Reaction: Stop at nearest floor. Car out of service until fault cleared.
Troubleshooting: 1. Check for excessive ambient temperature. 2. Check for insufficient air flow through the drive, especially if the fault is generated when the car is running and clears when the car is stopped. Verify that the fan is operating properly. Check the fan fuse. 3. Check for bad or failing SCR. 4. Check for defective fault-generating thermostat. There are two heat sensors, one on each heat sink. Check the integrity of the heat sensor's normally closed contacts. 5. Check the drive's rated armature current to determine if it is operating close to the limit threshold. Please refer to "Current Limit Adjustments" in Section 2.
SCR Instantaneous Over Current, SCR INST OVER CURRENT
Description: This fault indicates that the System 12 SCR Drive detected excessive armature current. DC controls only.
Car Reaction: Emergency Stop.
Troubleshooting: 1. Check that the main supply is being shut off during regeneration. 2. Check for a clipped door lock. 3. Check for a motor connection problem. 4. Possible failure of an SCR in the System 12 Drive.
SCR Insufficient Armature Current, SCR INSF ARM CURRENT
Description: This fault indicates that insufficient armature feedback current has been detected. This fault is generated if the requested current is at least 20% of the rated armature current yet the detected feedback remains below 10% of the rated armature current. Automatically resets if detected four or fewer times in seven consecutive runs. DC controls only.
Car Reaction: Emergency Stop.
Troubleshooting: 1. Check Armature Voltage Limit and Armature Current Limit settings on iView/Drive/Safety. If this fault occurs when the car is running at speed, adjust Motor Field so that armature voltage is within rated motor armature voltage. 2. Verify current sensor connection on SCR-LGA board (section 8). Check SCR-LGA board. 3. Check serial cable from drive to iBox. 4. Monitor the Up and Down direction inputs on the SCR-LGA board (bottom of R14 down, bottom of R22 up). If there is a momentary drop in the direction signal before the run is complete, use jumpers to determine if a section of the safety string is failing. WARNING: The car must be on Independent Service before performing this test. 5. If the failure persists from the beginning of the run, make sure the current signal on SCR-LGA board test point TP3 is not dropping out.

Table 6.3 iControl Messages

iControl Messages
SCR Loop Over Current, SCR LOOP OVER CURRENT
Description: DC loop current has grossly exceeded the reference value.
Car Reaction: Emergency Stop. DC controls only.
Troubleshooting: <ol style="list-style-type: none"> 1. Verify that the brake is completely lifting. 2. Check that the load in the car is not in excess of full load.
SCR Low Line Caution Activated, SCR Low Line Caution, SCR LOW LINE CAUTION
Description: The iBox has determined that the line voltage to the System 12 Drive is between 80% and 95% of rated armature voltage. The line voltage test occurs every time the elevator stops. The detected percentage is based on the Rated Armature Voltage parameter setting on the iView Drive Configuration screen > General tab. DC controls only.
Car Reaction: None. Elevator speed is limited to the detected line voltage percentage.
Troubleshooting: <ol style="list-style-type: none"> 1. Verify that the Rated Armature Voltage parameter value is correct. The RMS value (AC phase measurement on a voltmeter) at TP4 on the System 12 SCR-LGA board reflects the line voltage divided by one hundred (The RMS values of the line-to-line voltages at the wye and delta connections of the drive or secondary isolation transformer). 2. Verify the voltage into the primary of the Drive Isolation Transformer is not sagging. 3. Check the drive header rating against the voltage on the isolation transformer secondary.
SCR Low Line Caution Deactivated. See SCR Low Line Caution Activated.
Description: The iBox has determined that the line voltage to the System 12 Drive is above 90% of rated armature voltage (see SCR Low Line Caution (Activated)). DC controls only.
SCR Low Line Fault, SCR LOW LINE FAULT
Description: Indicates that AC line voltage to the System 12 Drive has dropped below 95% of the SCR-LGA header value. DC controls only.
Car Reaction: Car will not move.
Troubleshooting: <ol style="list-style-type: none"> 1. Verify that the Rated Armature Voltage parameter value is correct. The RMS value (AC phase measurement on a voltmeter) at TP4 on the System 12 SCR-LGA board reflects the line voltage divided by one hundred (The RMS values of the line-to-line voltages at the wye and delta connections of the drive or secondary isolation transformer). 2. Verify the voltage into the primary of the Drive Isolation Transformer is not sagging. 3. Check the drive header rating against the voltage on the isolation transformer secondary.
SCR Low Line Test Fault
Description: The test to determine the line voltage to the System 12 drive has failed to determine the line voltage (see SCR Low Line Caution Activated). DC controls only.
Car Reaction: None. Previous line voltage test values are used.
Troubleshooting: Possible internal hardware error on iBox trying to update System 12 drive's MDAC.
SCR Phase Lock Loop Fault, SCR PHASE LCK LP FLT
Description: This fault indicates that the phase lock loop circuit PLL LED is ON in the SCR-LGA and that the System 12 SCR Drive was unable to lock onto the incoming line frequency. The PLL LED is normally on for a few seconds during power up. DC controls only.
Car Reaction: Car will not move.
Troubleshooting: <ol style="list-style-type: none"> 1. Contact MCE technical support.

Table 6.3 iControl Messages

iControl Messages
SCR Phase Lock Loop Warning
Description: This fault indicates that the phase lock loop circuit PLL LED is ON in the SCR-LGA and that the System 12 SCR Drive was unable to lock onto the incoming line frequency. The PLL LED is normally on for a few seconds during power up. Detected while the car is not moving. DC controls only.
Car Reaction: Car will not move.
Troubleshooting: <ol style="list-style-type: none"> 1. Verify that the PLL indicator is active on the SCR-LGA board. 2. Verify that the iBox is not resetting the SCR drive. If it is, the PLL indicator will be active for a short interval. For a recurring drive fault, the iBox should reset the SCR drive every 15 seconds. If so, there is probably an underlying fault that the iBox is trying to clear. 3. Contact MCE technical support.
SCR Power Supply Fault, SCR POWER SUPPLY FLT
Description: Indicates that power supplied to the System 12 SCR Drive is insufficient. DC controls only.
Car Reaction: Car will not run.
Troubleshooting: <ol style="list-style-type: none"> 1. Check all supply voltages on the SCR-PS board (section 8). 2. Check the F2D fuse. 3. Verify voltages inside the drive are within 1%. If voltages are correct, check the drive cable from the iBox to the drive. Check the SCR-LGA board (section 8).
Secondary Fire Switch On, SEC FIRE SWITCH ON
Description: The Secondary Fire Recall Switch is in the ON position.
Car Reaction: The car will recall to the Main fire recall floor, position its doors as indicated on the Car Operation/Fire/Modify/Fire Recall screen, and await activation of the in-car firefighter switch.
Troubleshooting: If in error, check the Secondary Fire Recall switch input.
Serial COP Bus 'n' Comm Fault, SCOP BUS 'n' COMM FAULT (n = 1 - 4)
Description: Indicates lost communication between the ICE-CTP (cartop processor) board and the ICE-COP (serial COP) board for at least 1.5 seconds.
Car Reaction: none
Troubleshooting: <ol style="list-style-type: none"> 1. Check for a bad cable between the ICE-CTP and ICE-COP boards. 2. Check for a bad ICE-COP board. 3. Check for high electrical noise interference. 4. Check for proper shielding of the cables (board to board and board to controller).
Serial COP Bus 'n' Inventory Fault, SCOP BUS 'n' INVENTORY FLT (n = 1 - 4)
Description: Can indicate lost communication between the ICE-COP (serial COP) board and one or more ICE-COP-x boards. Could also indicate that an ICE-COP-x board was connected or disconnected after the system was powered up (I/O inventory changed).
Car Reaction: none
Troubleshooting: <ol style="list-style-type: none"> 1. Check for bad cable(s) between the ICE-COP and ICE-COP-x boards. 2. Check for a bad ICE-COP-x board. 3. Press the RESET button on the ICE-COP board (takes a new inventory).

Table 6.3 iControl Messages

iControl Messages
Sheave Brake Drop Fault, SHEAVE BRAKE DROP FLT
Description: The sheave brake was disabled via Sheave Brake Enable output, but the Sheave Brake Monitor input was high. There is a five second delay before fault is generated.
Car Reaction: Emergency stop: Motor contactor and brake contactor immediately dropped. All calls are cancelled. The doors will cycle.
Troubleshooting: <ol style="list-style-type: none"> 1. Verify that the Sheave Brake Monitor input and Sheave Brake Enable output have been programmed (Configuration > I/O Boards > Configuration tab). 2. Check the voltage at the Sheave Brake Monitor input and the internal representation via the <i>View</i> button on the Configuration > I/O Boards > Configuration tab. 3. Check the voltage at the Sheave Brake Enable output and the internal representation via the <i>View</i> button on the Configuration > I/O Boards > Configuration tab. 4. Check the sheave brake mechanism and circuitry.
Sheave Brake Pick Fault, SHEAVE BRAKE PICK FLT
Description: The sheave brake was enabled via Sheave Brake Enable output, but the Sheave Brake Monitor input was low. There is a five second delay before a fault is generated.
Car Reaction: Emergency stop: Motor contactor and brake contactor immediately dropped. All calls are cancelled. The doors will cycle.
Troubleshooting: <ol style="list-style-type: none"> 1. Verify that the Sheave Brake Monitor input and Sheave Brake Enable output have been programmed (Configuration > I/O Boards > Configuration tab). 2. Check the voltage at the Sheave Brake Monitor input and the internal representation via the <i>View</i> button on the Configuration > I/O Boards > Configuration tab. 3. Check the voltage at the Sheave Brake Enable output and the internal representation via the <i>View</i> button on the Configuration > I/O Boards > Configuration tab. 4. Check the sheave brake mechanism and circuitry.
Shuttle Service Activated, SHUTTLE SERVICE ON
Description: Indicates that Shuttle service has been activated via key-switch/input, software command or timer.
Shuttle Service Deactivated, SHUTTLE SERVICE OFF (see Shuttle Service Activated)
Single Channel QUAD Fault, SNG CHANNEL QUAD FLT
Description: This fault indicates the failure of one of the two landing system quadrature signals (DP1 or DP2).
Car Reaction: Emergency stop: Motor contactor and brake contactor immediately dropped.
Troubleshooting: <ol style="list-style-type: none"> 1. Check DP1 and DP2 wiring from the landing system to the iBox.
Software Recall Switch Activated, SOFTWARE RECALL ON
Description: The software recall command has been activated via iMonitor.
Car Reaction: The car recalls to the specified floor. Car calls and doors operate as specified by the software recall command parameters.
Troubleshooting: Check the status of the recall command and related parameters.
SPA Spare Event 'n' (n = 1 to 8)
Description: SPA Spare Events 1 through 8 are used for testing.
Speed Limit, MF Forcing, SPD LMT MF FORCING
Description: The system detected armature current without the armature current command. (The motor field is forced to help dynamic braking slow the car.) DC controls only.
Car Reaction:
Troubleshooting: <ol style="list-style-type: none"> 1. Check that the brake is setting properly.

Table 6.3 iControl Messages

iControl Messages
Stuck Cartop Inspection Input, STUCK CT INSP. INPUT
Description: Stuck inspection monitoring is enabled by the <i>Monitor cartop and car panel inspection inputs</i> option (Setup > Safety > Configuration tab). During passenger (automatic) operation, this message is generated if any of the cartop inspection inputs (CTEN, ICTU, ICTD) remain high for more than 250msec. During inspection operation, this message is generated if any combination of cartop inspection inputs remain high for more than five seconds, except for the following two, Enable plus Up (CTEN + ICTU) and Enable plus Down (CTEN + ICTD).
Car Reaction: None
Troubleshooting: Check and fix the car panel inspection buttons and related circuitry (Enable, Up, Down).
Stuck Car Panel Inspection Input, STUCK CP INSP. INPUT
Description: Stuck inspection monitoring is enabled by the <i>Monitor cartop and car panel inspection inputs</i> option (Setup > Safety > Configuration tab). During passenger (automatic) operation, this message is generated if any of the car panel inspection inputs (ICEN, ICPU, ICPD) remain high for more than 250msec. During inspection operation, this message is generated if any combination of car panel inspection inputs remain high for more than five seconds, except for the following two, Enable plus Up (ICEN + ICPU) and Enable plus Down (ICEN + ICPD).
Car Reaction: None
Troubleshooting: Check and fix the cartop inspection buttons and related circuitry (Enable, Up, Down).
Stuck Inspection Input Fault, STUCK IN. INPUT FLT
Description: This fault is generated when a stuck inspection input is detected during passenger (automatic) operation (see Stuck Cartop / Car Panel Inspection Input message). The fault is not generated if the car was on inspection operation. To avoid entrapment, the fault is not generated until the car has reached a floor.
Car Reaction: All hall calls are reassigned or canceled. The car will complete its run. When the car is at a floor, doors are cycled to let the passengers out and all car calls are canceled. The car is shut down and remains out-of-service until the fault is cleared.
Troubleshooting: Check and fix all inspection inputs/buttons. Then press the iBox Fault reset button.
Swing Operation Activated, Swing Operation, SWING OPERATION
Description: Indicates that the car is in swing car operation, independent of the Group Controller. The car should be servicing a riser of hall calls dedicated to the car. The car will use settings from the Simplex Hall Call and Parking related settings from the car Simplex supervisor screens.
Swing Operation Deactivated. See Swing Operation Activated.
SYSTEM SYNC
Description: The iBox is establishing communication with the cartop and acquiring position data.
Tach Error Fault, TACH ERROR FAULT
Description: Indicates that the difference between the intended speed and the speed feedback signal has exceeded the Following Error parameter.
Car Reaction: Emergency stop: Motor contactor and brake contactor immediately dropped. Followed by normal run.
Troubleshooting: 1. Please refer to "Tach Error Tripping Threshold Adjustment" on page 4-41.
Tach Failure, TACH FAILURE
Description: Indicates that the difference between the synthetic tach signal and the external speed feedback signal has exceeded the tolerance value. DC controls only.
Car Reaction: Emergency stop: Motor contactor and brake contactor immediately dropped. Cancel all calls.
Troubleshooting: 1. Check velocity encoder and re-calibrate tach failure and synthetic tach. Please refer to "Tach Failure Calibration" on page 2-62 and see "synthetic speed Calibration" on page 4-18.

Table 6.3 iControl Messages

iControl Messages
TERMINAL LEARN ON
Description: This status message, on the iBox display, indicates that the system is prepared to learn the speed and position values for the normal (UNT1-5/DNT1-5) and emergency (UETS/DETS) terminal switches.
Terminal Synchronization Fault, TERMINAL SYNC FAULT
Description: The system either did not receive edge position data from the cartop or the system did not detect a floor position magnet where expected.
Car Reaction: The car stops after crossing the floor magnet at the top or bottom terminal landing and is not allowed to move.
Troubleshooting: <ol style="list-style-type: none"> 1. Verify that the car was not moved after power was shut off. 2. Verify that the up/down normal terminal switch #5 opens at the appropriate location. When the up/down switch opens, no LU or LD sensor should be active. Also, only one floor magnet should be encountered in the direction of travel after the up/down switch opens. 3. Move the car past floors around the vicinity of the fault and verify the proper activation of the LU and LD sensors. 4. Verify that the system is communicating with the cartop (no Cartop Communication Fault). 5. Verify that the absolute and cartop positions change by the same amount and same direction while moving the car. 6. Verify that the terminal magnet has not fallen off. 7. Check the clearance between the floor sensor board and the magnets. Sometimes this clearance will be off just enough to make some magnets fail to register properly. Adjust the clearance if necessary. 8. Re-learn the floor heights. 9. The iLink, iLand or iBox may be faulty.
Test Mode, Test
Description: Indicates that the elevator is in the Test mode of operation. iBox Test switch in Test position.
Car Reaction: Door operation is disabled. This setting is used to adjust or test the elevator.
This Car Alternate Fire Sensor Recall, THIS CAR ALT FIRE
Description: Recall to the alternate fire floor due to active or latched smoke detector input(s) from the cars hoistway or machine room.
Car Reaction: Car proceeds to the user-defined alternate fire recall floor. Once at the recall floor, door operation is according to the user-defined door operation under fire recall operation. The fire warning indicator light will flash.
Troubleshooting: <ol style="list-style-type: none"> 1. If in error, inspect the sensors, inputs, and connections. 2. Related Inputs: This Car Alt Recall sensor inputs as shown on the job prints.
This Car Main Fire Sensor Recall, THIS CAR MAIN FIRE
Description: Recall to the main fire floor due to active or latched smoke detector input(s) from the cars hoistway or machine room.
Car Reaction: Car proceeds to the user-defined main fire recall floor. Once at the recall floor, door operation is according to the user-defined door operation under fire recall operation. The fire warning indicator light will flash.
Troubleshooting: <ol style="list-style-type: none"> 1. If in error, inspect the sensors, inputs, and connections. 2. Related Inputs: This Car Main Recall sensor inputs as shown on the job prints.
Unintended Motion Fault (see Safety A Unintended Motion Fault)

Table 6.3 iControl Messages

iControl Messages
Up Direction Limit Open, UP DIR LIMIT OPEN
Description: The up normal terminal direction switch is open
Car Reaction: Immediate stop if moving. Further up direction movement is prevented.
Troubleshooting: <ol style="list-style-type: none"> 1. Verify that the switch is operating properly. 2. Verify correct state of the iBox UNTD input. 3. Verify UNTD switch activating/deactivating at the appropriate location (normally 2" below the bottom terminal landing - see prints).
Up Emergency Terminal Switch Position Fault, UP ETS POSITION FAULT
Description: The reported position upon encountering the Terminal Switch differed from the learned switch position by more than the set position margin. This fault may be bypassed on the Diagnostics > Fault Bypass tab.
Car Reaction: Emergency Stop: Motor contactor and brake contactor immediately dropped. All hall and car calls are cancelled. After the car is stopped, it will run at Correction speed to the next available floor and cycle the door. Door Open button will remain operational. If generated when car is moving, fault will stay latched and the Fault Reset button must be pushed to clear it. If generated when the car is not moving, fault will self clear when condition no longer exists.
Troubleshooting: <ol style="list-style-type: none"> 1. Physically check the integrity of the switch and wiring. 2. Check the iBox input for the switch. 3. On the Diagnostics > Terminal Switches Status tab, compare the Last pass position to the Learned position for this switch. Verify that Position Margin is within a reasonable range (Configuration > Terminal Switches tab). If appropriate, move the switch closer to the terminal landing. 4. Relearn the NTS and ETS switches. Please refer to "Learning Normal & Emergency Terminal Limit Switches" on page 4-9.
Up Emergency Terminal Switch Shutdown, UP ETS SHUTDOWN
Description: The Up Emergency Terminal Switch opened at a speed or position exceeding its specified threshold. The fault stays latched and the Fault Reset button must be pushed to clear it. If generated when the car is stopped, the fault will self clear when the condition no longer exists.
Car Reaction: Emergency stop: Motor contactor and brake contactor immediately dropped.
Troubleshooting: <ol style="list-style-type: none"> 1. This fault is logged in conjunction with either a speed or position fault at UETS. Check the Event Log and follow the troubleshooting recommended for the Up Emergency Terminal Switch Position Fault or Safety A (or B) UETS Level 2 Speed Fault. 2. Press iBox Fault Reset to clear the fault.

Table 6.3 iControl Messages

iControl Messages
Up Normal Terminal Switch 'n' Level 1 Speed Fault, UP NTS'n' L1 SPEED FLT (n = 1 to 5)
Description: A Level 1 Overspeed fault has been detected at Up Normal Terminal switch 'n' (1 to 5). When the switch opened, the car was traveling faster than defined by Level 1 overspeed settings (sum of learned speed plus Overspeed 1 Margin percentage setting on Configuration > Terminal Switches tab) but not fast enough to trigger the Level 2 overspeed fault. This fault may be bypassed on the Diagnostics > Fault Bypass tab.
Car Reaction: Controlled stop using Emergency Slowdown pattern parameters.
Troubleshooting: <ol style="list-style-type: none"> 1. On the Diagnostics > Terminal Switches Status tab, compare the Last pass and Learned speeds for this switch. If appropriate, increase the Overspeed 1 Margin on the Configuration > Terminal Switches tab. 2. May be caused by a change in the Pattern parameters. Always re-learn the terminal switches after any changes to Pattern parameters. 3. One or two floor runs can sometimes come in "hotter" than multi-floor runs. (the switches are learned making full hatch runs). If short runs are causing the problem, increase the Overspeed 1 Margin (Configuration > Terminal Switches tab) or lower the Standard profile - High Roll Jerk parameter (Configuration > Pattern > Modes tab). 4. Can also be caused by a car that is following the pattern poorly, possibly due to heavy load or poor speed loop performance. In this case, adjust the speed loop to follow pattern as well as possible and/or alter the pattern parameters to produce a gentler deceleration and approach to the floor (then re-learn the switches). Please refer to "Terminal Switch Overspeed and Position Faults" on page 4-55.
Up Normal Terminal Switch 'n' Level 2 Speed Fault, UP NTS'n' L2 SPEED FLT (n = 1 to 5)
Description: A Level 2 Overspeed fault has been detected at Up Normal Terminal switch 'n' (1 to 5). The car was traveling faster than defined by Level 2 overspeed settings (105% of sum of learned speed plus Overspeed 1 Margin percentage setting on Configuration > Terminal Switches tab). This fault may be bypassed on the Diagnostics > Fault Bypass tab.
Car Reaction: Emergency stop: Motor contactor and brake contactor immediately dropped.
Troubleshooting: <ol style="list-style-type: none"> 1. Check the Diagnostics > Terminal Switches Status tab to see how fast the car was traveling on the Last pass by this switch. Check this value against the Learned speed for the switch. If appropriate, increase the Overspeed 1 Margin on the Configuration > Terminal Switches tab. 2. May be caused by a change in the Pattern parameters. Always re-learn the terminal switches after any changes to Pattern parameters. 3. One or two floor runs can sometimes come in "hotter" than multi-floor runs. (Remember that the switches are learned making full hatch runs.) If short runs are causing this, you may have to increase the Overspeed 1 Margin or lower the Standard profile - High Roll Jerk parameter. 4. Can also be caused by a car that is following the pattern poorly, possibly due to heavy load or poor speed loop performance. In this case, you need to get the speed loop adjusted to follow pattern as well as possible and/or alter the pattern parameters to produce a gentler deceleration and approach to the floor (then re-learn the switches). Please refer to "Terminal Switch Overspeed and Position Faults" on page 4-55.

Table 6.3 iControl Messages

iControl Messages
Up Normal Terminal Switch 'n' Position Fault, UP NTS'n' POSITION FLT (n = 1 to 6)
Description: When the switch opened or closed, the car's reported position was different from the learned position by a value exceeding the margin set on the Configuration > Terminal Switches tab. This may mean that the switch opened early, late or not at all on approach to the terminal. It may also mean that the switch closed early, late, or not at all on departure from the terminal. Finally, the switch can go open while standing at a floor where its learned position is closed, or go closed at a floor where its learned position is open. This fault may be bypassed on the Diagnostics > Fault Bypass tab.
Car Reaction: If traveling up, the car executes an emergency slowdown, then continue at low speed until it encounters a floor. The car stops at the floor, opens its doors, and performs a floor sync operation. If the fault persists, the car goes out of service. If traveling down, the car continues normally to the first stop, opens its doors and performs a floor sync operation. If the fault persists, the car goes out of service. If stopped at a floor, the car opens its doors, does a floor sync, and, if the fault persists, goes out of service.
Troubleshooting: <ol style="list-style-type: none"> 1. On the Diagnostics > Terminal Switches Status tab, compare the Last pass position to the Learned position for this switch. 2. If the fault is mechanical (switch movement, magnet movement, or bad traveler cable), the fault will tend to repeat at the same position every time. 3. A stuck switch is easy to spot by running the car on inspection and observing the input LEDs on the iBox. 4. Perform a Terminal Sync operation (Terminal button on the Configuration > Pattern > Common tab).
User code accessing an invalid logical indicator (internal event)
User Event 'n' Off (n = 1- 10) (see User Defined Event 'n' On)
User Event 'n' On (n = 1 - 10), User Defined Event Fault, USER DEF EVENT FAULT
Description: Indicates that User Event 'x' (1 - 10) has been activated via User Input 'n' (1 - 10)
Car Reaction: Determined by user programming (Configuration > User Inputs tab)
Troubleshooting: Determined by user programming (Configuration > User Inputs tab)
Vector Checksum Fault (see Safety Inventory Checksum Fault)
Vector Comparison Fault (see Safety Inventory Comparison Fault)
Vector Creation Fault (see Safety Inventory Creation Fault)
Vector Learn Fault (see Safety Inventory Learn Fault)
Watchdog Ordered Control Stop Before Reset
Description: A critical component in the system has locked up.
Car Reaction: The car will come to a controlled stop and the system will reboot automatically.
Troubleshooting:
Watchdog Ordered Emergency Stop Before Reset
Description: A critical component in the system has locked up.
Car Reaction: The car will perform an emergency stop and the system will reboot automatically.
Troubleshooting:

Circuit Boards and Assemblies

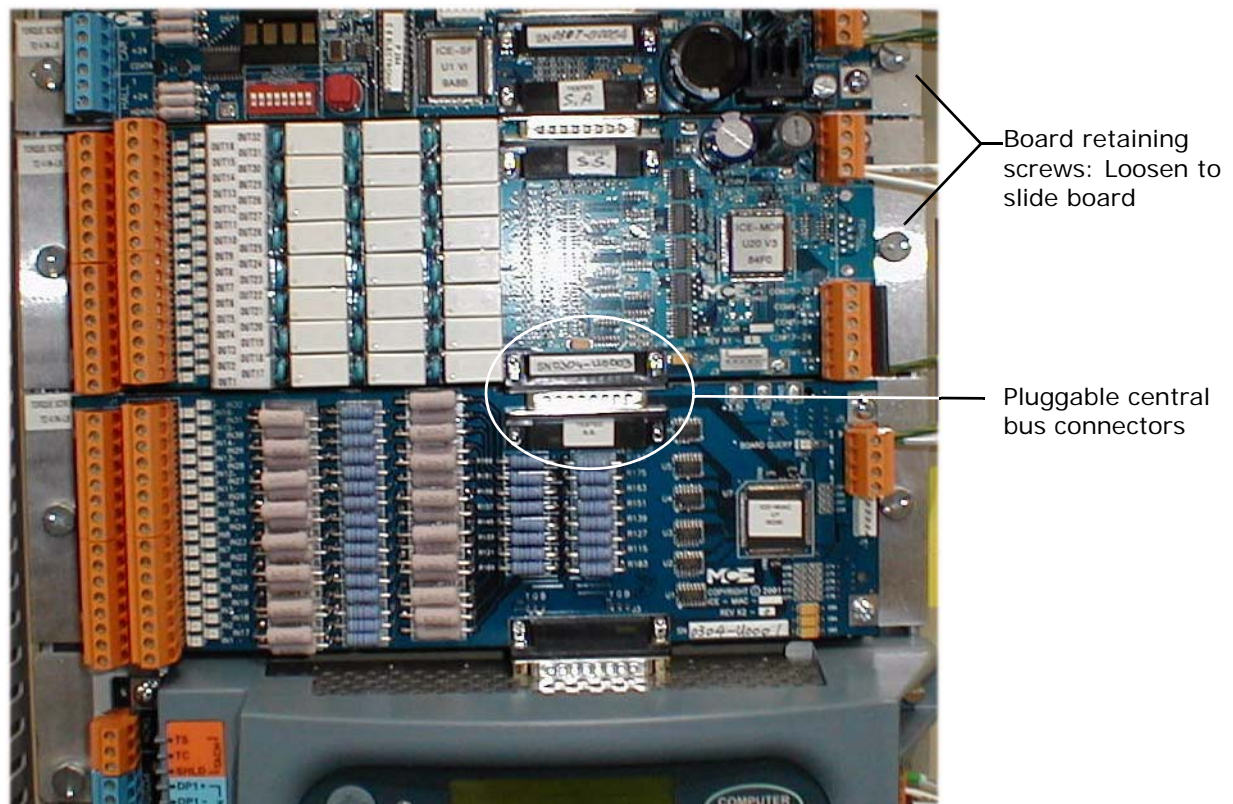
This section contains information to help you troubleshoot and replace iControl circuit boards and assemblies, including:

- Circuit board removal and replacement
- iBox removal and replacement (see “iBox Removal and Replacement” on page 6-80).
- Circuit board QRs (see “iControl Circuit Board Quick References” on page 6-82).

Circuit Board Removal and Replacement

Peripheral circuit boards in iControl and in the iLink cartop box are connected along a central, pluggable bus. The boards are mounted on slide-tracks so that, if you need to replace a board you can loosen the mounting bolts of the boards above or below it, slide them away, then loosen, slide, and remove the board you need to replace. In iControl, the central bus extends both above and below the iBox.

Figure 6.1 Circuit Board Removal and Replacement



6

Note

Before using iView to assign or reassign inputs or outputs to I/O boards, consult MCE so that your job prints can be corrected. Remember that reassigning an input or output will also require appropriate re-routing of the wiring.

iBox Removal and Replacement

The iBox is designed for relatively simple removal and replacement. The configuration file for the original iBox can be uploaded from a computer to the replacement iBox so that many operational settings will be in place. Some information, like floor heights and brake calibration, etc., may need to be “re-learned” when an iBox is replaced. This section contains:

- iBox Archive File
- iBox Removal
- [iBox Installation](#)
- [iBox File Upload](#)

iBox Configuration File

As described in Section 8 of this guide, you can easily save the configuration information for the iBox to a computer hard drive (see [“Saving Parameters to a Configuration File” on page 8-20](#)). Some or all of the information in this file can then be “uploaded” to the same or another iBox, simplifying configuration.

1. Locate the archive file for the iBox you need to replace. If no archive file exists, depending on the nature of the malfunction, you may be able to create an archive file now:
2. Connect to the iBox through its #3 PC Ethernet connector.
3. Select *Save to File* from the *File* menu.

A typical Windows save dialog will appear. The default name suggested for the file will be the controller connection name with param.xml appended, i.e. if the connection name was CarA, the suggested file name would be CarAparam.xml. The default file suggested in the dialog will be the file folder that contains the connection icon for the controller. You may change either or both of the default suggestions and store the file wherever you wish under any name you wish. As with any Windows file, if you change or delete the file extension (.xml) it will lose its association with the application that created it. It is best to leave the file extension as-is.

4. Save the file to the desired location.

iBox Removal

1. Shut off power at the main disconnect.
2. Open the iControl cabinet.
3. Loosen the iBox cover retaining screws and remove the cover.
4. Unplug all connections to the body of the iBox. You can leave the connections to the rail-mounted circuit boards above and below the iBox connected.
5. Slightly loosen the retaining screws for the rail-mounted circuit boards and slide them away from the iBox (disconnecting the pluggable central bus).
6. Loosen the four captive, retaining screws that secure the iBox to the circuit board rails.
7. Remove the iBox.

iBox Installation

1. Verify that power is off at the main disconnect.
2. Open the iControl cabinet.
3. Remove the cover (bezel) from the new iBox.
4. Secure the new iBox in position between the rail-mounted circuit boards.
5. Slide the rail-mounted circuit boards above and below the iBox back into position so that the central bus is plugged back in.
6. Tighten the board retaining screws.
7. Reconnect all cabling to the body of the iBox.

iBox File Upload

While online (connected to a controller, you may select a Configuration (.cfg) file and send all or selected data from that file to the controller. [Please refer to “Loading Parameters from a Configuration File” on page 8-22.](#)

iControl Circuit Board Quick References

This section contains information about iControl circuit boards and assemblies, including photographs with informational call outs, input/outputs, indicators, jumpers, test points and other information pertinent to troubleshooting.

The circuit boards are listed in the table below. If you are viewing this file on a computer, click the page number to jump to the appropriate section.

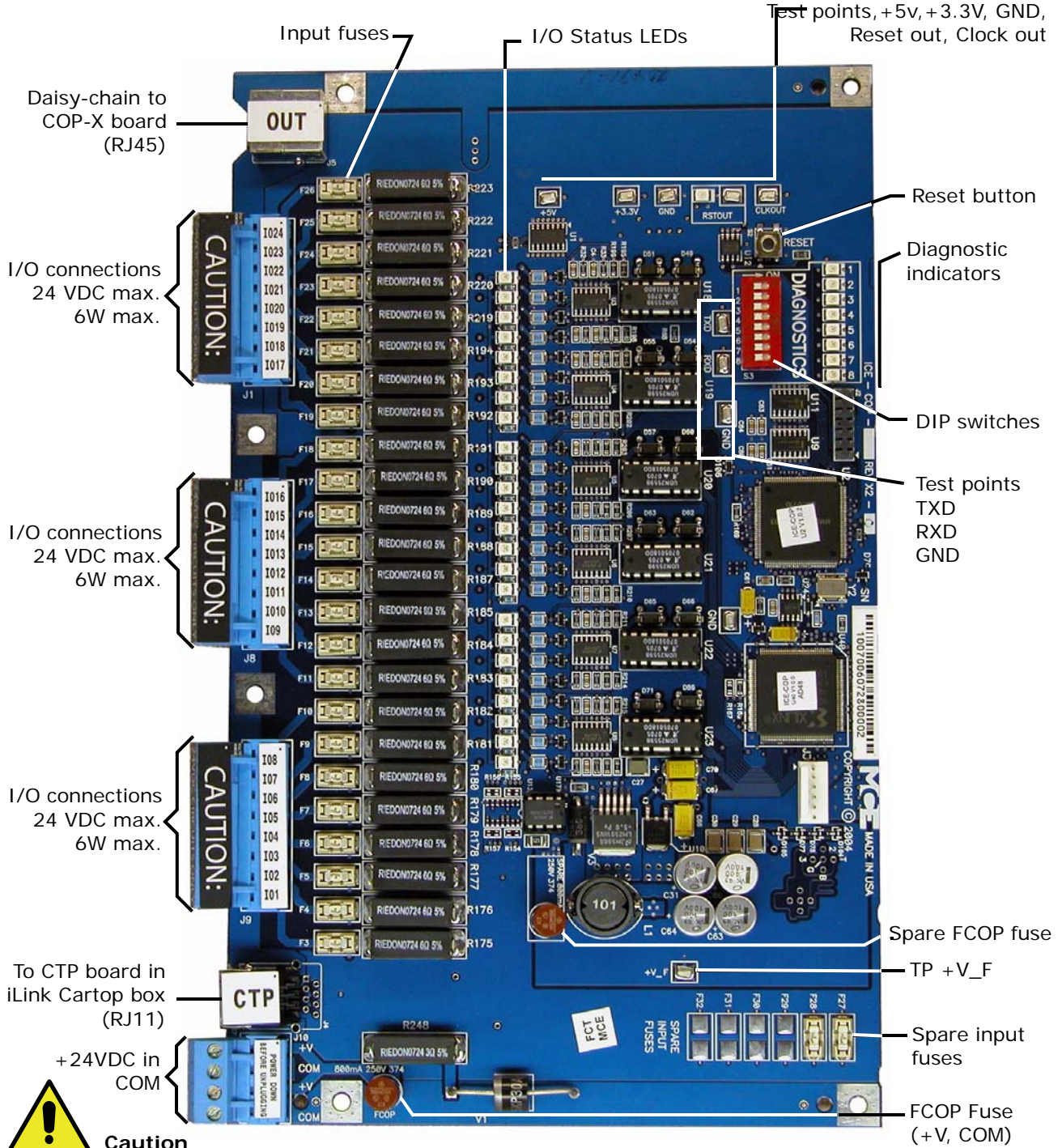
Table 6.4 iControl Circuit Boards

Board	Name	Where Used	See
ICE-COP	Serial Car Operating Panel Board	Car Operating Panels	page 6-83
ICE-CTP	Car Top Processor Board	iLink Car Top Interconnect	page 6-86
ICE-EB	Emergency Brake Board	iControl AC and DC	page 6-92
ICE-FML	Field Module Logic Board	iControl AD, DC	page 6-93
ICE-IEQ	Earthquake Board	iControl AC, DC	page 6-96
ICE-IMP	Main Processor Board	iControl AC, DC	page 6-98
ICE-IRB	Relay Board	iControl AC, DC	page 6-100
ICE-IRD	Rear Door Board	iControl AC, DC	page 6-103
ICE-LCB	Low Current Brake Board	iControl AC, DC	page 6-104
ICE-MIAC	Multiple Input AC Board	iControl AC, DC, iCentral Group, iLink	page 6-104
ICE-MOR	Multiple Output Relay Board	iControl AC, DC, iCentral Group, iLink	page 6-107
ICE-RG	Rope Gripper Board	iControl AC, DC	page 6-109
ICE-SAF	Safety Board	iControl AC, DC	page 6-111
ICE-SF	Serial Fixture Board	iControl AC, DC	page 6-116
SC-HCDA-ISO	Serial Hall Call Driver Isolation Board	iControl AC, DC Simplex / Swing Car	page 6-117
SC-HCE-ME	Serial Hall Call Ethernet - Digi Board	iCentral Group	page 6-118
SC-HCN	Serial Hall Call Node Board	Hall Call Fixture Enclosures	page 6-119
SC-ION	Serial Control I/O Node Board	iCentral Group	page 6-116

ICE-COP Serial Car Operating Panel Board QR

The Serial Car Operating Panel system provides serial communication of the car operating panel signals. Multiple ICE-COP and ICE-COP-X boards daisy-chain together to accommodate high-rise installations.

Figure 7. ICE-COP Serial Car Operating Panel Board



Caution
This system is designed for 24 VDC circuits maximum. Connecting 120VAC or DC will open the input fuses.

ICE-COP Board Diagnostics

The DIP switches and LEDs in the upper right corner of the ICE-COP board provide diagnostic information. Note: The DIP switches must be in the fully ON or fully OFF position to function reliably. Be sure to push the switches firmly in the appropriate direction when setting the switches. The use of a small screwdriver or ballpoint pen is recommended.

LED 1 Regardless of the switch settings, LED 1 is ON when an interrupt is being serviced. In normal operation it turns on and off quickly enough that it is almost as bright as a fully illuminated LED. If LED 1 stays OFF, it indicates that the board is not functioning normally and should be reset (press the RESET button).

Manual Reset Regardless of switch settings, the LEDs have the same meaning during reset and startup.

- When the reset button is held down, all LEDs should illuminate.
- When the reset button is released, the LEDs will light up one at a time in the following sequence - (8, 7, 6, 5, 4, 3, 2, 1, 2, 3, 4, 5, 6, 7, 8). Normal operation should commence immediately following the reset sequence.

If the reset sequence consists of three iterations of all LEDs on at the same time followed by all LEDs off, the board has been programmed with a non-production version of firmware. The board should be reprogrammed.

Normal Operation The normal operating condition is with all DIP switches OFF. This gives the normal operation display as follows:

- LED4: This is the “alive” indicator. It should toggle every 40ms.
- LED5: Toggles when a block of data is sent to the cartop, approximately once every 50ms.
- LED8: Toggles when a block of data is received from the cartop, approximately once every 50ms.

When the cartop is not active, only LED4 will toggle. When the cartop is active and normal operations are in progress, all three LEDs will toggle regularly.



Board Version The version and revision of the ICE-COP board can be determined using the DIP switches and LEDs 3 through 8 (ignore LEDs 1 and 2) The values are in hexadecimal, with LED8 bring the 2^0 bit. For example, if the number were “01”, LED 8 would be ON and LEDs 3 through 7 would be OFF (LEDs 1 and 2 are not part of the value and must be ignored).

- DIP switch 6 = ON, all others = OFF: Major version number displayed on LEDs.
- DIP switch 7 = ON, all others = OFF: Minor version number displayed on LEDs.
- DIP switch 8 = ON, all others = OFF: Revision number displayed on LEDs.

Receive Serial Data Set DIP switches 5 and 7 = ON and all others = OFF. When the LEDs are ON they indicate the following:

- LED3: The CRC check indicates that bad data was received.
- LED4: The CRC check indicates that good data was received.
- LED5: A CRC character has been received.
- LED6: Data characters are being received from the cartop.
- LED7: An STX character has been received from the cartop.
- LED8: A non-STX character has been detected when an STX character was expected.

In normal operation, LEDs 5, 6, and 7 will glow faintly and LED 4 will blink roughly once every 40ms. If LED 3 or 8 is bright, bad data is being received from the cartop. This suggests that there is a serial line quality problem.

Transmit Serial Data Set DIP switch 6 = ON and all others = OFF. When the LEDs are ON they indicate the following:

- LED4: The transmitter was busy when the board attempted to send data.
- LED5: The board is sending CRC characters.
- LED6: The board is sending data characters.
- LED7: The board is sending STX characters.
- LED8: The transmitter is in the RESET condition.

In normal operation, LEDs 5, 6, and 7 will glow faintly. If either LED 4 or 8 comes on and stays on, the board has malfunctioned. If a manual reset does not clear the problem, there is a hardware problem on the ICE-COP board.

ICE-CTP Cartop Processor Board Quick Reference

The Cartop Processor board handles local control and communications for the iLink cartop interconnect. Like the iBox, the Cartop Processor usually has track-mounted expansion boards for extra inputs and outputs.

Figure 6.1 ICE-CTP Cartop Processor Board

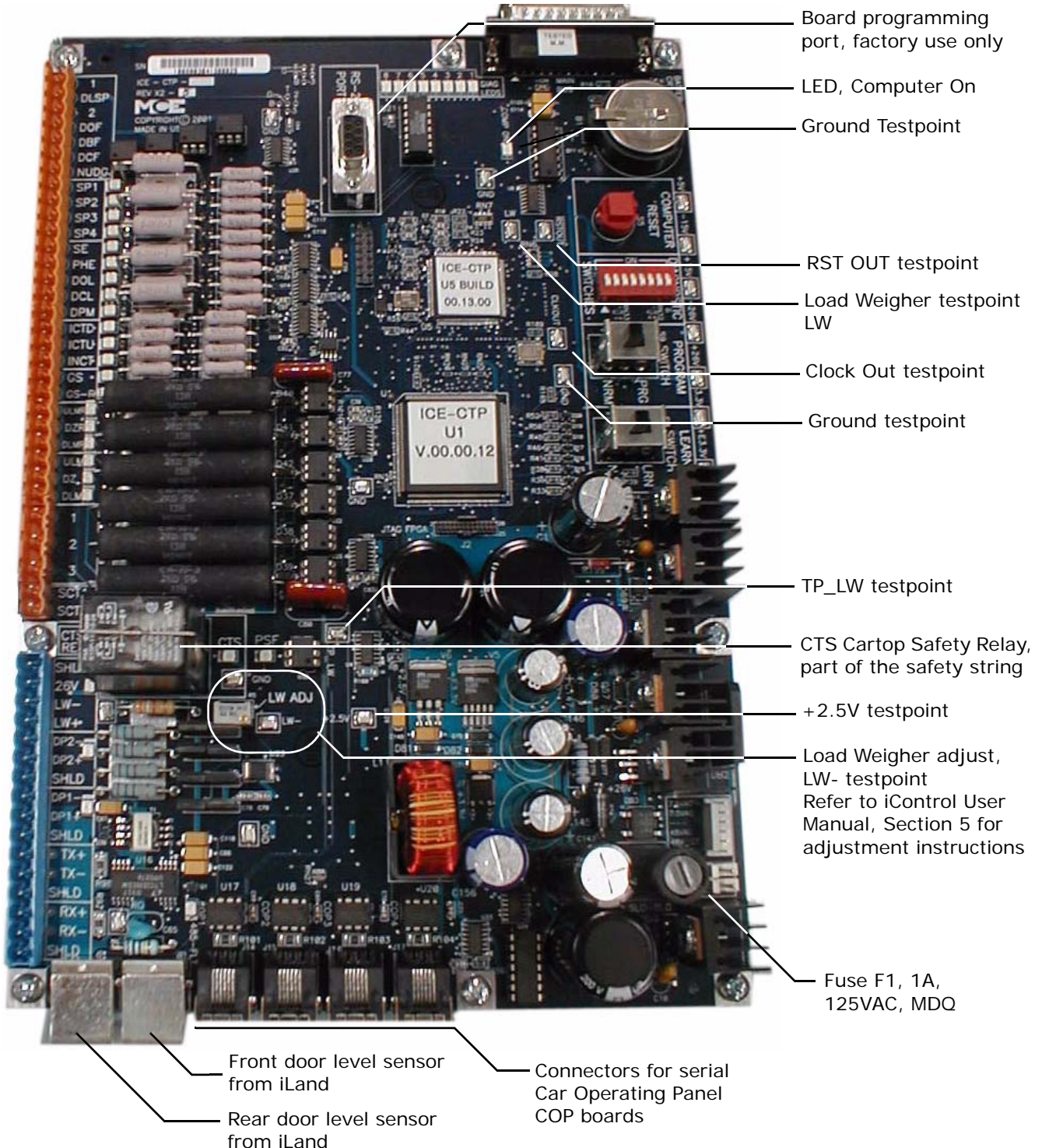


Table 6.5 ICE-CTP Board Connections

Terminal	Description
1	Common
DLSP	Door Logic Supply (See job prints for source level)
2	120VAC
DOF	Door Open Function output (active level =DLSP)
DBF	Door Boost Function output (active level =DLSP)
DCF	Door Close Function output (active level =DLSP)
NUDG	Door Nudge output (active level =DLSP)
SP1	Spare Input (120VAC signal level)
SP2	Spare Input (120VAC signal level)
SP3	Spare Input (120VAC signal level)
SP4	Spare Input (120VAC signal level)
SE	(Door) Safe Edge Input (120VAC signal level)
PHE	Photo Eye input (120VAC signal level)
DOL	Door Open Limit input (120VAC signal level)
DCL	Door Close Limit input (120VAC signal level)
DPM	Door Position Monitor input (120VAC signal level)
ICTD	Cartop inspection down button (110VDC= switch closed)
ICTU	Cartop inspection up button (110VDC= switch closed)
INCT	Cartop inspection switch active (110VDC= switch closed)
GS	Gate Switch input (110VDC= switch closed)
GSR	Gate Switch Rear (110VDC= switch closed)
ULMR	Up Level Marker Rear output (110VDC= output active)
DZR	Door Zone Rear (110VDC= output active)
DLMR	Down Level Marker Rear (110VDC= output active)
ULM	Up Level Marker (110VDC= output active)
DZ	Door Zone (110VDC= output active)
DLM	Down Level Marker (110VDC= output active)
1	Common
2	120VAC
3	110VDC
SCT1	Cartop Safety Contact 1 (110VDC= contact closed)
SCT2	Cartop Safety Contact 2 (110VDC= contact closed)

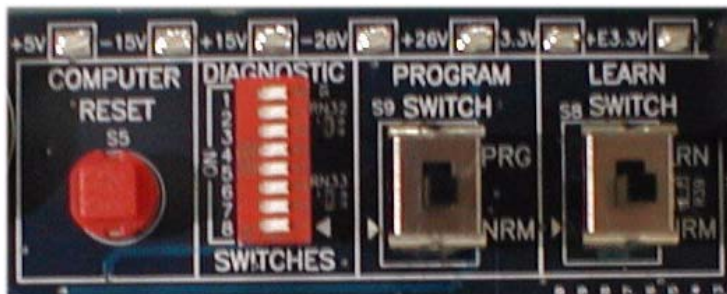
Table 6.6 ICE-CTP Board Connections

Terminal	Description
SHLD	Shield: Common
26V	26V output to load weigher
LW-	Input from Load Weigher (analog voltage)
LW+	Input from Load Weigher (analog voltage)
DP2-	Position input from iLand (balanced pair with DP2+)
DP2+	Position input from iLand (balanced pair with DP2-)
SHLD	Shield: Common
DP1-	Position input from iLand (balanced pair with DP1+)
DP1+	Position input from iLand (balanced pair with DP1-)
SHLD	Shield: Common
TX+	Transmit to iBox (connect to iBox terminal RX+)
TX-	Transmit to iBox (connect to iBox terminal RX-)
SHLD	Shield: Common
RX+	Receive from iBox (connect to iBox terminal TX+)
RX-	Receive from iBox (connect to iBox terminal TX-)
SHLD	Shield: Common

Table 6.7 ICE-CTP Board Testpoints

Testpoint	State
GND (x4)	Ground testpoints
Volt (x8)	+2.5, +3.3, +5, -15V, +15V, -26V, +26V
LW	Measured from LW to TP_LW, 0.3 — 1.0 VDC = Empty car.
LW-	Measured from LW- to TP_L@, -0.3 — -1.0 VDC = Empty car.
TP_LW	Measured from TP_LW to GND, 4 — 8 VDC = Full car.
RSTOUT	0V= computer reset
CLKOUT	33MHz microprocessor clock

Figure 6.2 ICE-CTP Board Switches



- **Computer Reset:** Press to initialize the Cartop Processor board computer.
- **Diagnostic Switches:** Factory board test use only.
- **Program Switch:** Used at the factory during board programming.
- **Learn Switch:** Used at the factory during board programming.
- **Test points:** +5V, -15V, +15V, -26V, +26V, +3.3V, +E3.3V (emergency logic power provided by on board battery).

ICE-CTP Cartop Diagnostics

There are eight diagnostic LEDs on the CTP board inside the iLink enclosure. On power up or reset, these LEDs will light sequentially, first in one direction, then the other, after which they will briefly clear.

Diagnostic LED 1 Regardless of the switch settings, LED 8 is ON when an interrupt is being serviced. In normal operation it turns on and off quickly enough that it is almost as bright as a fully illuminated LED. If LED 8 stays OFF, it indicates that the board is not functioning normally and should be reset (press the RESET button).



Note

If there is a problem with communication between the iBox and the CTP board after initial installation, verify that the iBox TX+ and TX- terminals are connected to the CTP board RX+ and RX- terminals, and the iBox RX+ and RX- terminals are connected to the CTP board TX+ and TX- terminals (see [“ICE-CTP Board Connections” on page 6-88](#)).

Manual Reset Regardless of switch settings, the LEDs have the same meaning during reset and startup.

- When the reset button is release, the LEDs will light up one at a time in the following sequence - (1, 2, 3, 4, 5, 6, 7, 8, 7, 6, 5, 4, 3, 2, 1). Normal operation should commence immediately following the reset sequence.

If the reset sequence consists of three iterations of all LEDs on at the same time followed by all LEDs off, the board has been programmed with a non-production version of firmware. The board should be reprogrammed.

Diagnostic Switches The Diagnostic Switches, see [“ICE-CTP Board Switches” on page 6-88](#), must be in the fully ON or fully OFF position to function reliably. Be sure to push the switches firmly in the appropriate direction when setting the switches. The use of a small screwdriver or ballpoint pen is recommended.

Normal Operation The normal operating condition is with all DIP switches OFF. This gives the normal operation display as follows:

Table 6.8 Diagnostic Indicators (Normal Operation - All DIP Switches OFF)

LED	Description
1	Represents message input from iBox to iLink. With proper communication, toggles approximately every 80mS. Goes OFF and stays OFF if input is lost.
2	Indicates that the cartop detected an unintended motion safety fault. With the car on Passenger operation, after the car had reached a landing, the car moved at a speed greater than 150 feet-per-minute.
3	Indicates that the cartop detected an unintended motion safety fault. With the car on Inspection, after the car had reached a landing, the car moved with doors open.
4	Message output from iLink to iBox. With proper communication, toggles approximately every 80mS. Goes OFF and stays OFF if output is lost.
5	This is the "alive" indicator. It toggles every 80mS during normal operation.
6	Lights when the car is on Inspection mode.
7	Unused.
8	Indicates that an interrupt is being serviced. If it goes off and stays off, the board is not functioning normally and should be reset (press the RESET button).

When the iBox is not active, only LED 5 will toggle. When the iBox is active and normal operations are in progress, LEDs 1, 4 and 5 will toggle regularly.

Firmware Download Firmware updates can be downloaded via iView. [Please refer to "Controller - Firmware Update" on page 9-155.](#) Normally, no manual intervention is needed at the cartop. However, if a problem does develop, the following may be of use in recovering:

1. Set the S1 DIP switches 1, 6 and 8 = ON.
2. Press the manual Reset button on the ICE-CTP board. This tells the cartop firmware to wait for a firmware download without attempting to run the normal cartop application first.
3. Perform the firmware update using iView (File > Firmware Update).

Board Version The version and revision of the ICE-CTP board can be determined using the DIP switches and LEDs 1 through 6 (ignore LEDs 7 and 8) The values are in hexadecimal, with LED1 bring the 2⁰ bit. For example, if the number were "01", LED 1 would be ON and LEDs 2 through 6 would be OFF (LEDs 7 and 8 are not part of the value and must be ignored).

- DIP switch 3 = ON, all others = OFF: Major version number displayed on LEDs.
- DIP switch 2 = ON, all others = OFF: Minor version number displayed on LEDs.
- DIP switch 1 = ON, all others = OFF: Revision number displayed on LEDs.

Receive Serial Data There are five serial connections on the cartop - one to the iBox and up to four to Serial COP boards. Each connection can be monitored by setting the S1 DIP switches as described below:

- To monitor data received from iBox, set DIP switches 1 and 4 = ON.
- To monitor data received from COP1, set DIP switches 1, 2 and 4 = ON.
- To monitor data received from COP2, set DIP switches 1, 3 and 4 = ON.
- To monitor data received from COP3, set DIP switches 1, 2, 3 and 4 = ON.
- To monitor data received from COP4, set DIP switches 1, and 5 = ON.

When the LEDs are ON they indicate the following:

- LED1: A non-STX character has been detected when an STX character was expected.
- LED2: An STX character has been received from the cartop.
- LED3: Data characters are being received from the cartop.
- LED4: A CRC character has been received.
- LED5: The CRC check indicates that good data was received.
- LED6: The CRC check indicates that bad data was received.

In normal operation, LEDs 2, 3, and 5 will glow faintly and LED 4 will blink roughly once every 40ms. If LED 1 or 6 is bright, bad data is being received from the cartop. This suggests that there is a serial line quality problem.

Transmit Serial Data Set the S1 DIP switches as described below:

- To monitor data transmitted to iBox, set DIP switches 2 and 4 = ON.
- To monitor data transmitted to COP1, set DIP switches 3 and 4 = ON.
- To monitor data transmitted to COP2, set DIP switches 2, 3 and 4 = ON.
- To monitor data transmitted to COP3, set DIP switch 5 = ON.
- To monitor data transmitted to COP4, set DIP switches 2 and 5 = ON.

When the LEDs are ON they indicate the following:

- LED1: The transmitter is in the RESET condition.
- LED2: The board is sending STX characters.
- LED3: The board is sending data characters.
- LED4: The board is sending CRC characters.
- LED5: The transmitter was busy when the board attempted to send data.

In normal operation, LEDs 2, 3, and 4 will glow faintly. If either LED 1 or 5 comes on and stays on, the board has malfunctioned. If a manual reset does not clear the problem, there is a hardware problem on the ICE-CTP board.

If LEDs turn on and stay on, the board is not functioning normally and should be reset (press the RESET button). If the condition persists, there is likely a hardware problem on the board.

ICE-EB Emergency Brake Board Quick Reference

The Emergency Brake board is used in iControl AC and DC elevator controllers to control a hoist motor-mounted emergency brake. The emergency brake is typically a separate friction brake mounted on an extended or secondary sheave.

Figure 6.3 ICE-EB Emergency Brake Board

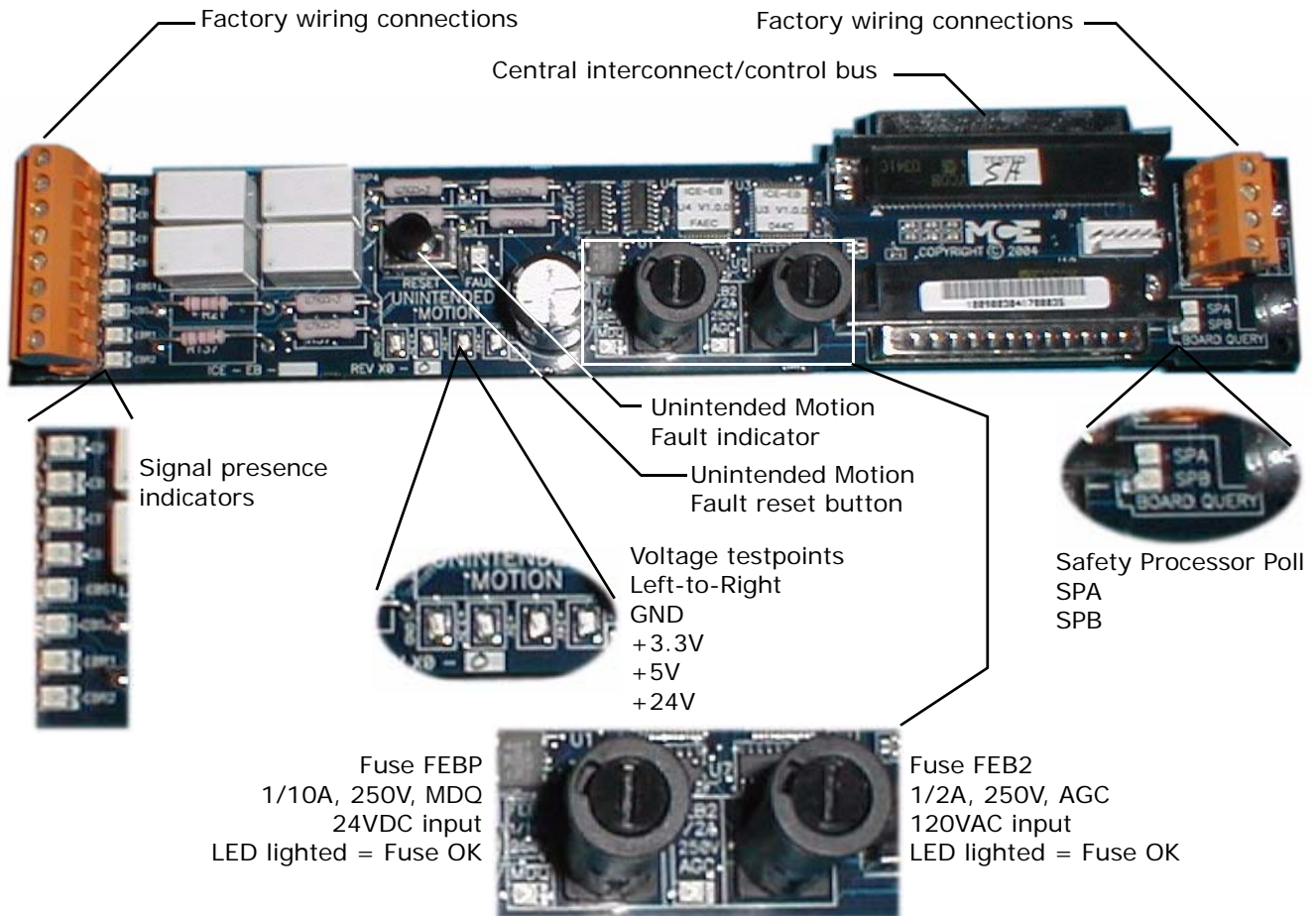


Table 6.9 ICE-EB Board Inputs and Outputs

Connector	Signal	Connector	Signal
	EBP1: 0VAC= Brk picked, 120VAC= Brk engaged		1: Common
	EBP2: 0VAC= Brk picked, 120VAC= Brk engaged		24X2: 24VDC input
	EBP3: 0VAC= Brk picked, 120VAC= Brk engaged		24: 24VDC input
	EBP4: 0VAC= Brk picked, 120VAC= Brk engaged		2: 120VAC input
	EBS1: 120VAC= Brk OK (picked)		
	EBS2: 120VAC= Brk OK (picked)		
	EBR1: 120VAC= Brk picked, 0VAC= Brk engaged		
	EBR2: 120VAC= Brk picked, 0VAC= Brk engaged		

The user makes no direct connections to this board. Refer to job prints for circuit information.

ICE-FML Field Module Logic Board Quick Reference

iField Modules are used to supply power to the brake on iControl AC and DC systems and to the motor field on iControl with DC drive. The iField Modules used for both purposes are the same, with the exception of the wiring to terminal J7 on the ICE-FMP, Field Module Power Board.

IFIELD-MODULE Specifications	
Inputs:	70 VAC min, 300 VAC max, 1 Phase, 50/60Hz, 42 AMPS Maximum
Outputs:	0 VDC minimum, 265 VDC maximum, 45 AMPS Maximum
OVER-CURRENT PROTECTION REQUIRED ON INPUT	
- For loads up to 30A - use Bussman type FNQ or LittleFuse type FLO	
- For loads over 30A - use Ferraz Shawmut type A50QS80-4 or LittleFuse type L50S80	

Figure 6.4 ICE-FML Field Module Logic Board

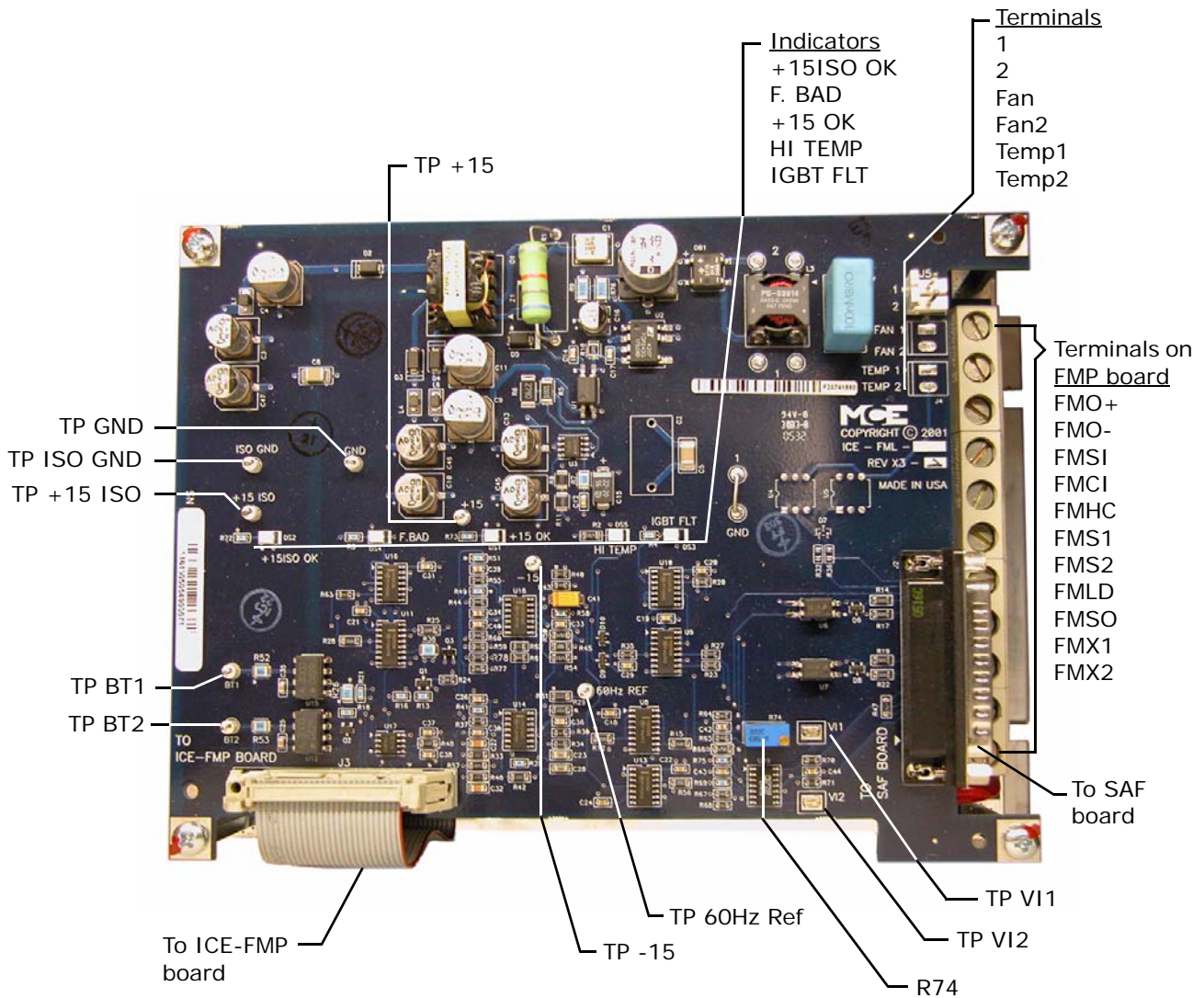


Table 6.10 IFIELD-MODULE Indicators on the ICE-FML Board

Indicators	Description
+15 ISO OK	LED indicator for isolated +15V power supply, measured with respect to isolated Ground, GND-ISO. Normally ON. Turns OFF when module loses +15 ISO voltage.
F. BAD	LED indicator for AC input on FMX1 and FMX2 terminals (on FMP board). Normally ON. Turns OFF when any input side AC fuse opens.
+15 OK	LED indicator for +15V power supply, measured with respect to Ground. Normally ON. Turns OFF when module loses +15V.
HI TEMP	LED turns ON to indicate high temperature on the heatsink. Normally OFF. Turns ON when the temperature of the main IGBT raises above 85°C (185°F).
IGBT FLT	LED turns ON to indicate that the AUX IGBT has failed open.

Table 6.11 IFIELD MODULE Terminals on the ICE-FML Board

Terminal	Description
1	1 BUS: AC input supply to the ICE-FML Board.
2	2B BUS: AC input supply to the ICE-FML Board.
FAN 1	(not used) Terminals for connecting an external fan.
FAN 2	(not used) Terminals for connecting an external fan.
TEMP 1	(not used) Terminals for connecting an external temperature sensor.
TEMP 2	(not used) Terminals for connecting an external temperature sensor.

Table 6.12 IFIELD-MODULE Terminals on the ICE-FMP Board (Brake Module)

Terminal	Description
FMO+	Field Module Output, positive, to brake coil.
FMO-	Field Module Output, negative, to brake coil.
FMSI	Field Module Safety Input: Jumpered to FMSO. FMSI and FMSO are always jumpered together unless there is a requirement for a mechanical safety contact to break between the load and the field module.
FMCI	Field Module Current Input: When load current is higher than 10A, jumper FMCI to FMHC. For load current less than 10A, leave both FMCI and FMHC open.
FMHC	Field Module High Current: See FMCI.
FMS1	Field Module Snubber 1: When used as a Brake Module, a shunt RC parallel network (RB & CB) is connected between FMS1 and FMLD.
FMS2	Field Module Snubber 2: N/C
FMLD	Field Module Load Diode: FMLD is connected to the cathode of a diode on the ICE-FMP board. FMLD is also connected to RC network RB & CB (see FMS1).
FMSO	Field Module Safety Output: Jumpered to FMSI. (see FMSI)
FMX1	AC power input to Field Module from brake contacts (70 VAC min, 300 VAC max)
FMX2	AC power input to Field Module from brake contacts (70 VAC min, 300 VAC max)

Table 6.13 IFIELD-MODULE Terminals on the ICE-FMP Board (Motor Field Module)

Terminal	Description
FMO+	Field Module Output, positive, to motor field.
FMO-	Field Module Output, negative, to motor field.
FMSI	Field Module Safety Input: Jumpered to FMSO. FMSI and FMSO are always jumpered together unless there is a requirement for a mechanical safety contact to break between the load and the field module.
FMCI	Field Module Current Input: When load current is higher than 10A, jumper FMCI to FMHC. For load current less than 10A, leave both FMCI and FMHC open.
FMHC	Field Module High Current: See FMCI.
FMS1	Field Module Snubber 1: When used as a Motor Field Module, an RC filter network (RM & CM) is connected between FMS1 and FMS2. FMS1 is also jumper to FMLD.
FMS2	Field Module Snubber 2: Connect to RC filter (CM) see FMS1.
FMLD	Field Module Load Diode: FMLD is connected to the cathode of a diode on the ICE-FMP board. FMLD is also jumpered to FMS1.
FMSO	Field Module Safety Output: Jumpered to FMSI. (see FMSI)
FMX1	AC power input to Field Module (70 VAC min, 300 VAC max)
FMX2	AC power input to Field Module (70 VAC min, 300 VAC max)

ICE-IEQ Earthquake Board Quick Reference

The Earthquake board provides an interface between motion sensing devices and the iControl elevator controller.

Figure 6.5 ICE-IEQ Earthquake Board

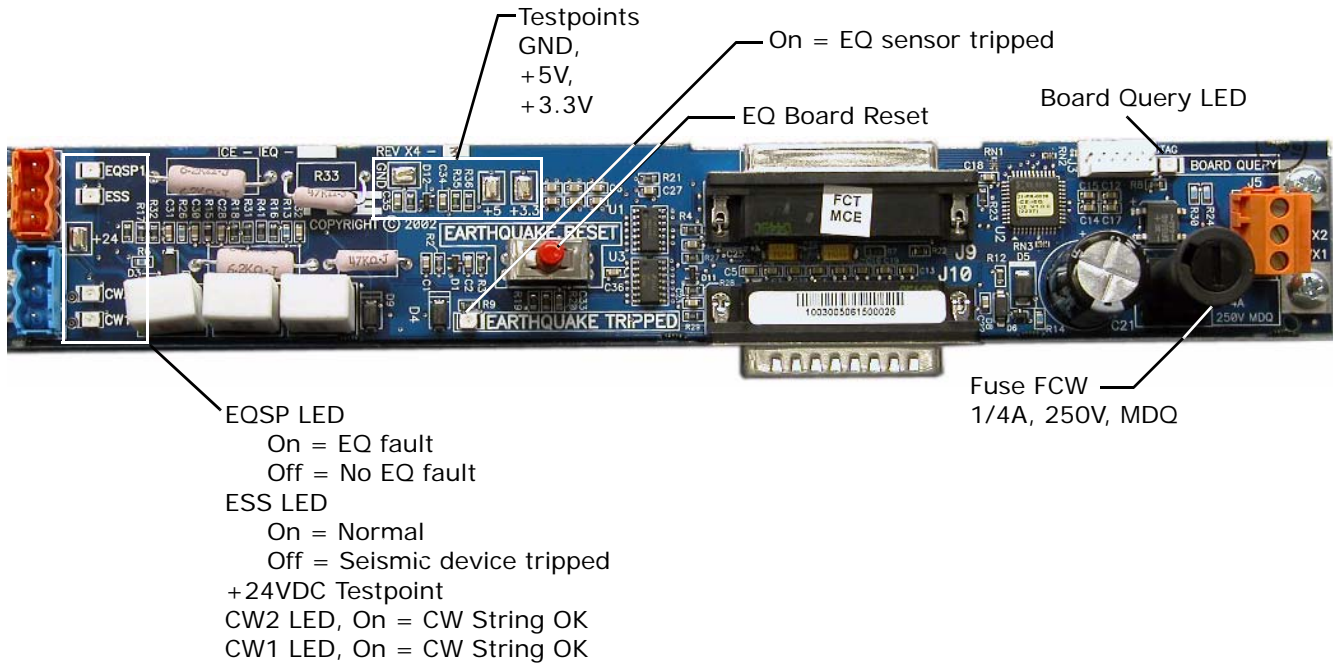
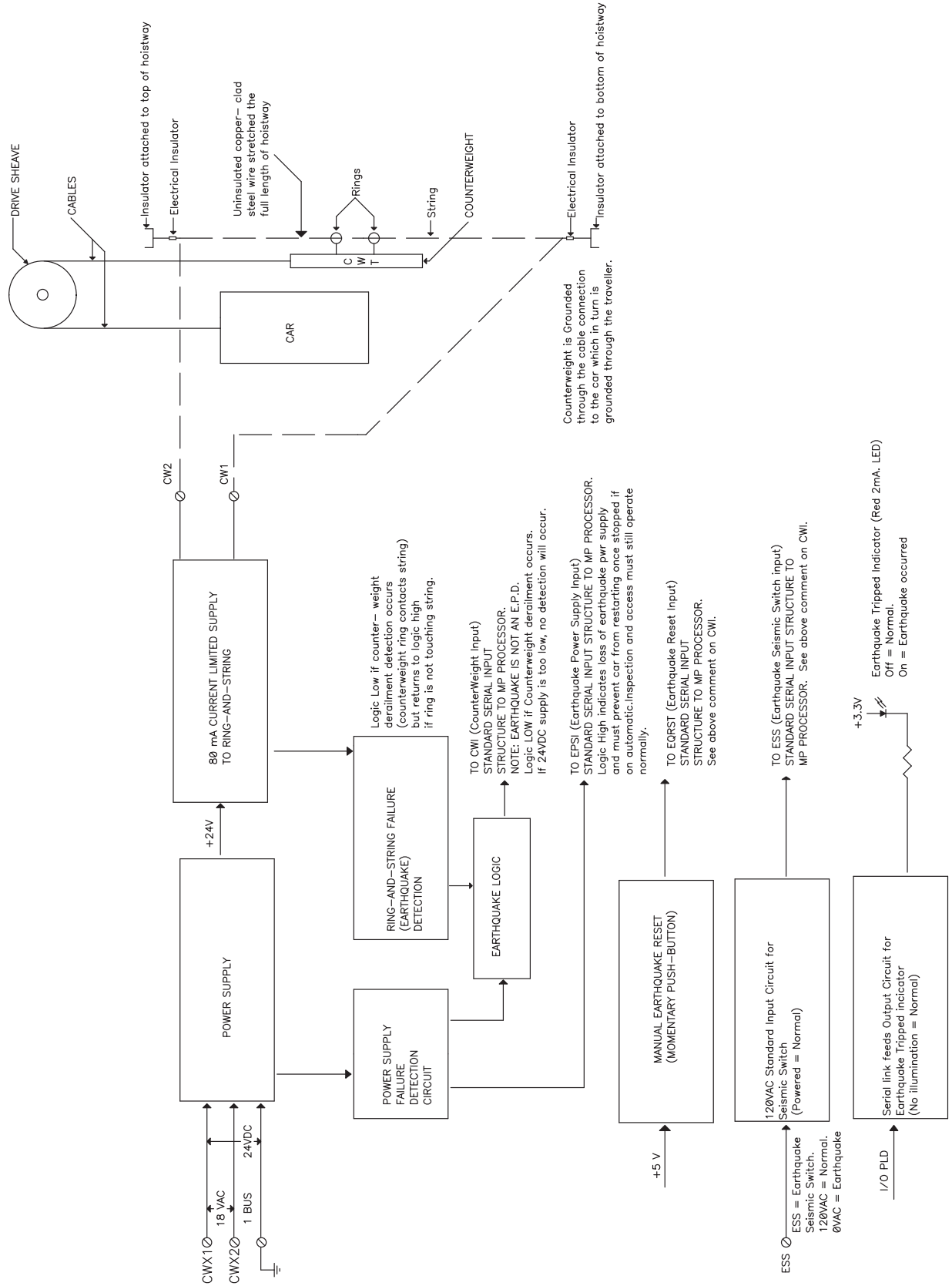


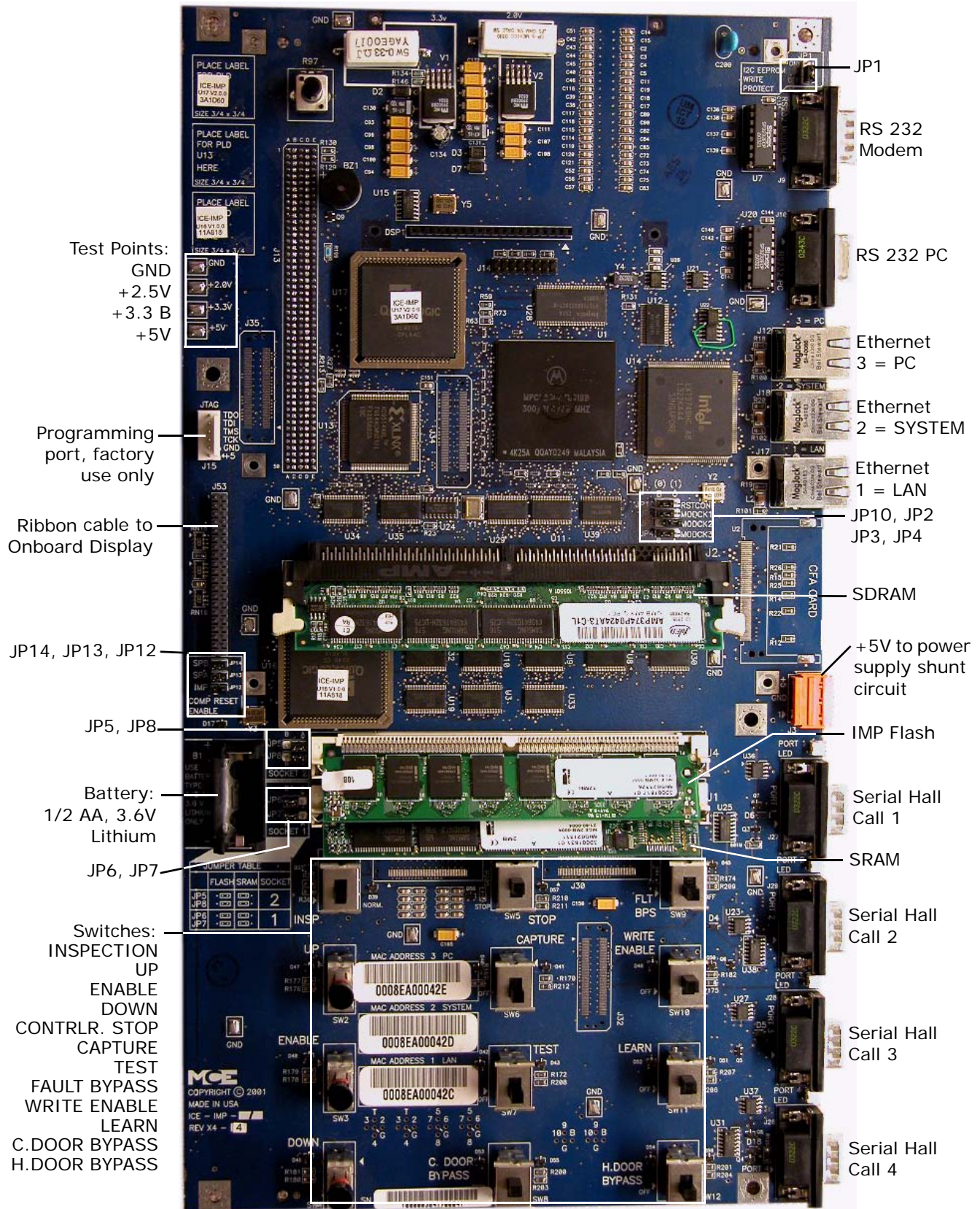
Table 6.14 Earthquake Board Connections

Connector	Signal	Connector	Signal
	EQSP 1: Spare. 0V=Normal. 120VAC=Tripped		1: Common
	ESS: 120VAC= Normal, 0V= Tripped (120VAC from #2 bus, through sensor to ESS)		CWX2: 18VAC
	CW2: 24VDC= Normal, 0V= String shorted		CWX1: 18VAC
	CW1: 24VDC= Normal, 0V= String shorted		

Figure 6.6 Earthquake Board, Supporting Information



ICE-IMP Main Processor Board Quick Reference



The ICE-IMP Main Processor Board is the heart of the iController. It provides the central processing, data storage, control switches and communication for each iControl AC or DC controller. The Onboard display and ICE-SAF boards plug into the ICE-IMP board.

Table 6.15 ICE-IMP Jumper Table

Jumper	Setting	Description
JP1	B	I ² C EEPROM Write Protect, A = ON, B = OFF
JP2	B	MODCK1, processor speed setting
JP3	A	MODCK2, processor speed setting
JP4	B	MODCK3, processor speed setting
JP5	A	Socket 2 setting, A = Flash, B = SRAM
JP6	B	Socket 1 setting, A = Flash, B = SRAM
JP7	B	Socket 1 setting, A = Flash, B = SRAM
JP8	A	Socket 2 setting, A = Flash, B = SRAM
JP10	B	RSTCONF, A = used for debugging, B = normal setting
JP12	ON*	IMP (iControl Main Processor): ON = enables iBox COMPUTER RESET button to reset this processor. *iBox Rev. 7 thru 10 have a wire from this jumper to the ICE-SAF board which allows resetting if any power supply voltages are out of tolerance. iBox Rev. 11 and above use an internal circuit for this purpose.
JP13	ON	SPA (Safety Processor A): ON = enables iBox COMPUTER RESET button to reset this processor.
JP14	ON	SPB (Safety Processor B): ON = enables iBox COMPUTER RESET button to reset this processor.

ICE-IRB Relay Board Quick Reference

The Relay Board is an integral part of the iBox. The three system relays mounted on the board are socketed and can be separately replaced. There are also six fuses protecting the 110VDC and 120VAC iBox output buses that may be replaced. Electrically, the Relay Board is between the iBox processor and the motor and brake field modules inside the iPower Box. The SB and 3 terminals are accessible through the front of the iBox and bypass the safety string when “jumped” together. If a jumper is placed, it “times out” automatically after 15 minutes.

Figure 6.7 ICE-IRB Relay Board

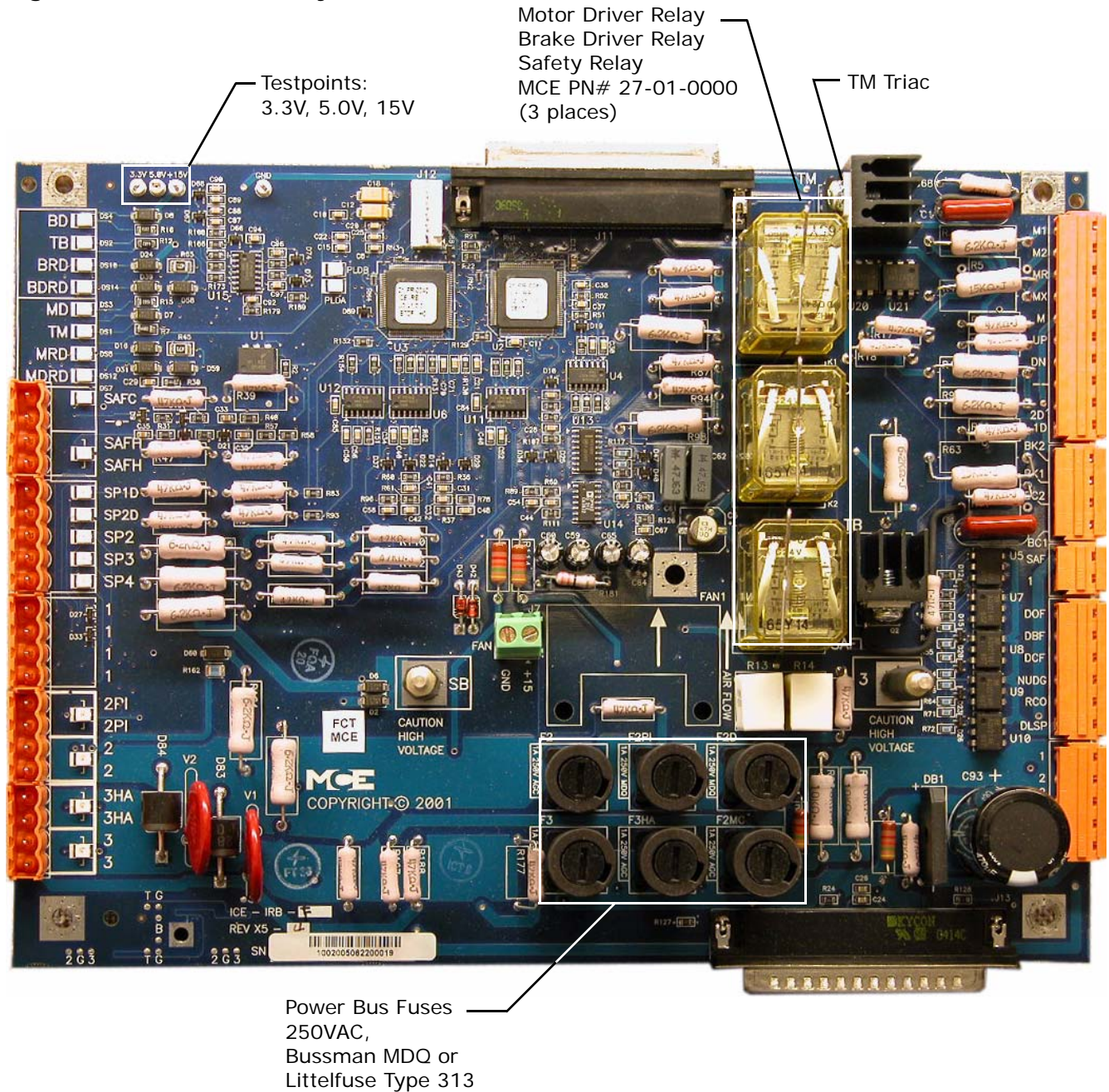


Table 6.16 ICE-IRB Relay Board

Signal (Left Edge)	Signal (Right Edge)
BD: Brake Driver relay indicator. When the BD relay on the Relay board is closed to pick the brake, this LED will light. Monitored by Safety Processor A.	M1: Drive contactor coil connection.
TB: Brake Triac active indicator. When the brake triac on the Relay board is active (completes circuit for BD relay), this LED will light. Monitored by Safety Processor B.	M2: Drive contactor coil connection.
BRD: Brake Redundancy. This LED lights when the main brake contactor drops out.	MR: Connects to drive contactor auxiliary contact for redundancy input.
BDRD: Brake Drive Redundancy. This LED lights when the BD relay drops out.	MX: Connects to drive contactor auxiliary contact for brake qualification.
MD: Motor Drive relay indicator. When the MD relay on the Relay board is closed to enable the motor, this LED will light. Monitored by Safety Processor A.	M: Part of MX circuit.
TM: Motor Triac active indicator. When the motor triac on the Relay board is active (completes circuit for MD relay), this LED will light. Monitored by Safety Processor B.	UP: Up direction output to MCE System 12 SCR Drive.
MRD: Motor Redundancy. This LED lights when the main motor contactor drops out.	DN: Down direction output to MCE System 12 SCR Drive.
MDRD: Motor Drive Redundancy. This LED lights when the MD relay drops out.	_ _ : Not connected.
SAFC: Safety Cartop input. Cartop safety relays and switches are wired in series between SAFH (Safety Hoistway) and SAFC. If any contact in the safety string opens, there will be 0VDC on this input and the car will not run. If all safety contacts in the string are closed, there will be 110VDC on this input.	2D: 120VAC power to the drive. Fused on IRB board (fuse F2D).
SAFH: Safety Hoistway input. Hoistway safety relays and switches are wired in series between the #3 bus and SAFH. The patch also includes the Governor switch, with the GOV connection providing access to the #3 bus via the governor switch. (#3 to GOV through governor switch, GOV to SAFH through hoistway safety relays and switches). The job prints for the job provide specific wiring instructions. If any contact in the safety string opens, there will be 0VDC on this input and the car will not run. If all safety contacts in the string are closed, there will be 110VDC on this input.	1D: System common to the drive - source is the 1 bus.
SP1 D: Optional input. See job prints.	BK2: Connects to the brake contactor for redundancy checking. The source of power for this circuit comes from fuse F2 on the IRB board.
SP2 D: Optional input. See job prints. (When used as a brake pick switch input: Set brake = 110VDC. Picked brake = 0VDC.	BK1: Connects to the brake contactor for redundancy checking. The source of power for this circuit comes from fuse F2 on the IRB board.
SP2: Optional input. See job prints.	BC1: Connects to the brake contactor coil (see job prints for connection).
SP3: Optional input. See job prints.	BC2: Connects to the brake contactor coil (see job prints for connection).

Signal (Left Edge)	Signal (Right Edge)
SP4: Optional input. See job prints.	SAF: When used, provides an additional SAF relay.
1: (4x) Common bus connections. 0VDC	1: Common bus.
2PI: (2x) 120VAC outputs for position indicator. LED ON = bus powered.	DOF: Door Open output.
2: (2x) #2 bus outputs. 120VAC. 2 LED lighted when bus is powered.	DBF: Door Boost Output.
3HA: (2x) #3 bus outputs for hoistway. 110VDC. 3HA LED lighted when bus is powered.	DCF: Door Close Output.
3: (2x) #3 bus outputs. 110VDC. 3 LED lighted when bus is powered.	NUDG: Door Nudging Output.
	RCO: Retiring Cam Output.
	DLSP: Door Logic Supply Voltage. Selectable (by wiring) power input to door control relays. See job prints.
	1: Common bus.
	2: (2x) 120VAC bus.
	3D: (2x): 110VDC bus.

Checking TM Triac on ICE-IRB Board

If the PM or M contactors are not picking, you might see the following fault messages:

- Motor Contactor Driver Proofing Fault
- Drive Ready On Fault
- Drive Enable Feedback Fault
- SCR Insufficient Armature Current



These faults do not necessarily mean that the problem is with the TM Triac. It is recommended to first consult the iControl Messages table in the Troubleshooting section and follow the troubleshooting tips for the message(s) displayed.

To check the TM triac:

1. With controller power off remove the cover on the iBox.
2. The TM triac is in the upper right hand corner of the ICE-IRB board, which is the lowest board under the iBox cover and has three relays on it.
3. Measure the resistance across the outside legs of the TM triac. The legs can be hard to get to depending on the probe leads used. You can get to the upper leg from the left and the lower leg from below.
4. If the resistance is 60-70 ohms then the triac is good and continue troubleshooting the fault. If the resistance is 15 ohms or less the ICE-IRB board needs to be replaced.

ICE-IRD Rear Door Board Quick Reference

The Rear Door board provides additional door zone inputs.

Figure 6.8 ICE-IRD Rear Door Board

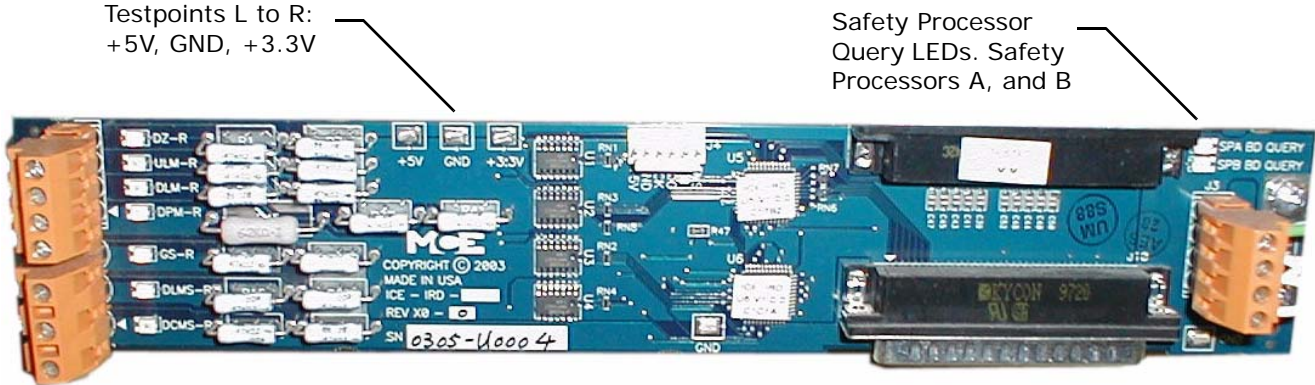


Table 6.17 Rear Door Board Connections

Connector	Signal	Connector	Signal
	DZ-R: Rear Door Zone signal from iLink. 110VDC active signal level. Off = 0.		1 (4x): Common bus connections.
	ULM-R: Rear Up Level Marker signal from iLink. 110VDC active signal level Off = 0.		
	DLM-R: Rear Down Level Marker signal from iLink. 110VDC active signal level. Off = 0.		
	DPM-R: Rear Door Position Monitor input. Door closed, input inactive. 120VAC. Door not closed, 0VAC.		
	GS-R: Rear Gate Switch input. The gate switch makes up when the elevator doors close. When the switch is made, there will be 110VDC on this input. When the switch is open, there will be 0VDC on this input. The gate switch may be wired in series with other switches or locks on the elevator doors (as shown in the job prints) so that, if any of the switches do not make, the GS input will remain low and the car will not run.		
	DLMS-R: Rear Door Lock Main String input. If top and bottom hoistway access is not provided, all hoistway rear door locks are wired in series between the #3 bus and this input. When the switch is made, there will be 110VDC on this input. When any switch is open, there will be 0VDC on this input and the car will not run.		
	DCMS-R: Rear Door Contact Main String input. If top and bottom hoistway access is not provided, all hoistway rear door contacts are wired in series between the #3 bus and this input. When the switch is made, there will be 110VDC on this input. When any switch is open, there will be 0VDC on this input and the car will not run.		

ICE-LCB Low Current Brake Board Quick Reference

Most iControls use the iField brake module for precise control of brake picking, holding, and application. If the requirements of the job permit, the Low Current Brake board may be used instead to provide simple brake pick and hold control. If used, the Low Current Brake board is usually mounted on the right wall inside the iPower Box. Brake adjusting components (resistors, capacitors, diodes) may be “wired in” to the board circuitry using AWG 18 wire and on-board screw terminals to modify the performance of the circuit. The job prints will show the Low Current Brake board connections clearly if it is used.

Table 6.18 Low Current Brake Board Signals

Signal	Use
B2 -, B1+	Brake voltage feedback signals to iControl Safety Board.
BKX1, BKX2	110VAC (typical) inputs to Low Current Brake Board rectifier.
BKD1	Brake Diode D1 cathode (used to include D1 in the circuit)
B2MCE	Used to include external components in the circuit
FBS1	Brake Diode D1 anode (used to include D1 in the circuit)
FBS2	Used to include external components in the circuit
BK2	Used to include external components in the circuit
BK1	Used to include capacitor C1 in the circuit
B1	Positive voltage output to brake coil via controller B1 terminal
B2	Return from brake coil via controller B2 terminal

ICE-MIAC Multiple Input AC Board Quick Reference

The ICE-MIAC board is used in AC and DC iControls and in the iLink cartop interconnect as a general purpose input board suitable for industry-common 117VAC input signal levels.

Figure 6.9 ICE-MIAC Multiple Input AC Board

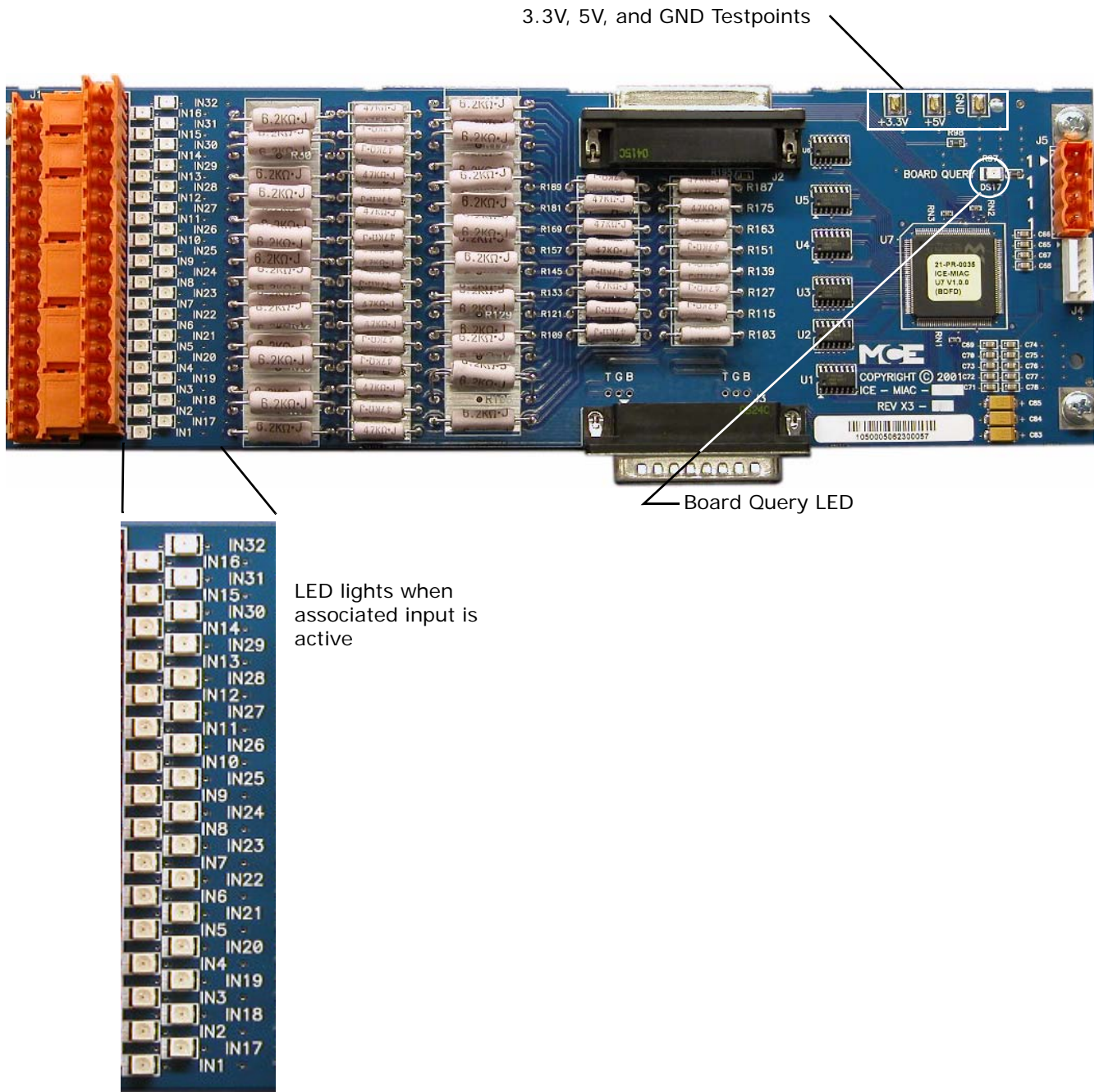
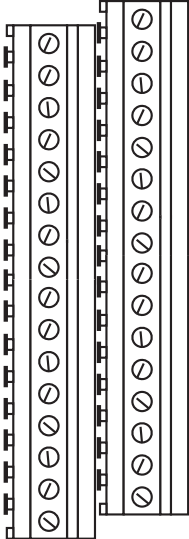
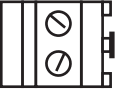
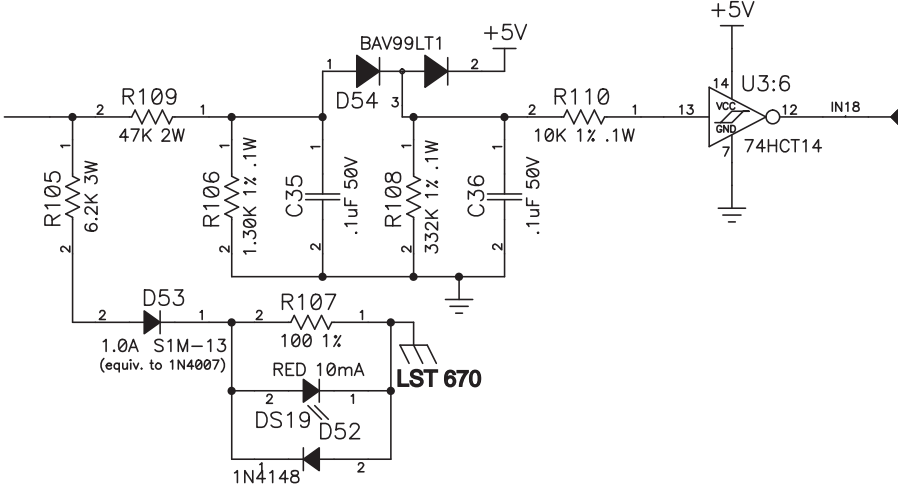


Table 6.19 ICE-MIAC Board Connections

Connector	Signal	Connector	Signal
	Inputs 1 - 32. 110VAC = input active		1: Common 1: Common
<p>Typical Input Circuit</p> 			

ICE-MOR Multiple Output Relay Board Quick Reference

The ICE-MOR board is a multi-purpose, relay-closure output board. ICE-MOR boards are used in iControl elevator controllers and in iLink cartop enclosures.

Output Connections

Connect outputs as shown in your job prints. Outputs may be configured (in specific groups) to provide either a path to ground or current to drive indicator lamps/LEDs.

Output State Selection The outputs are divided into five groups. Each group shares a common. The common may be wired to provide a current source or a path to ground. The groups are:

- Relays 1 – 4
- Relays 5 – 8
- Relays 9 – 16
- Relays 17 - 24
- Relays 25 - 32

The commons for the groups are determined by the connections made to board connector J5. The appropriate connections are determined during the job survey. Each system is configured before shipment. You need only connect outputs as shown on the job prints.

Table 6.20 ICE-MOR Board Connections

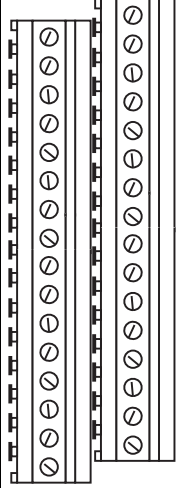
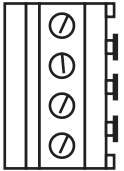
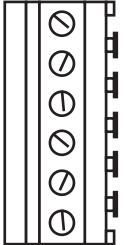
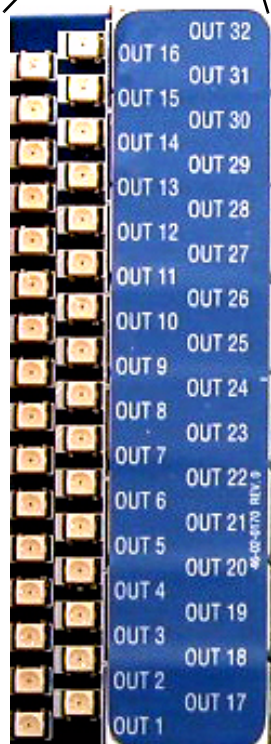
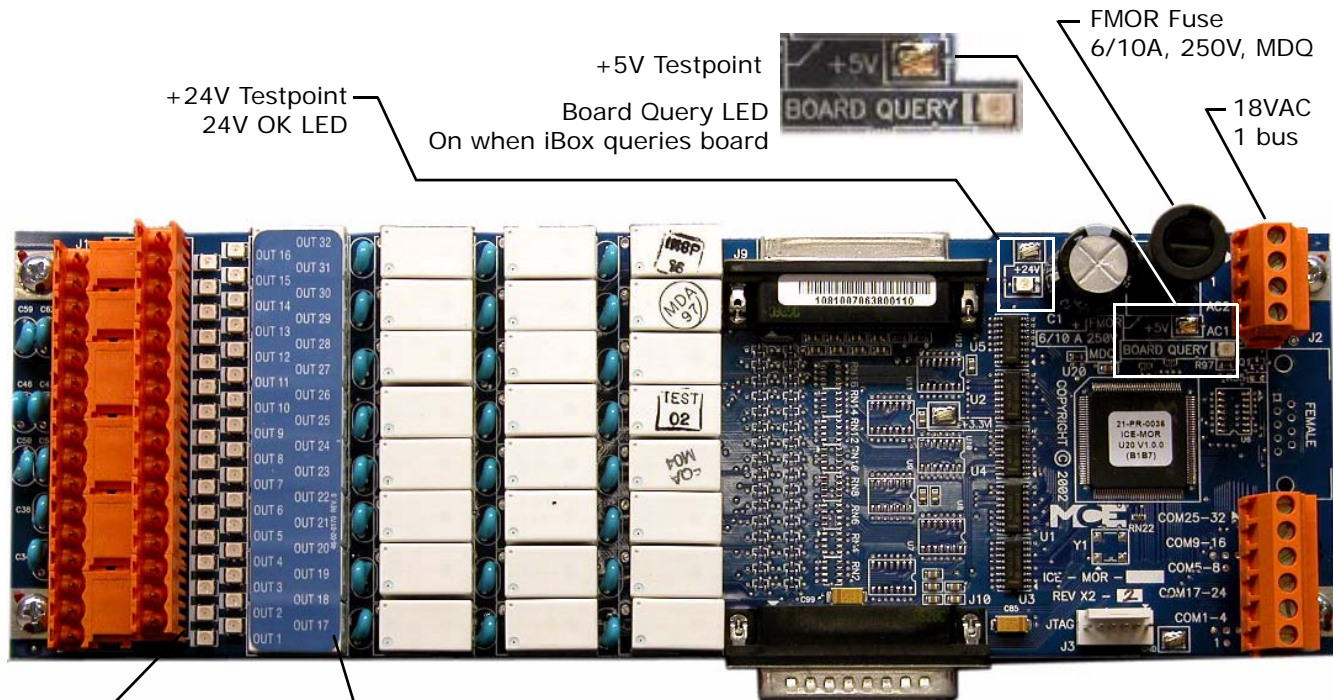
Connector	Signal	Connector	Signal
	Output determined by Common connection to board connector J5.		1: Common 1: Common AC2: MOR2, typical 18VAC AC1: MOR1, typical 18VAC
			Common 25 - 32 Common 9 - 16 Common 5 - 8 Common 17 - 24 Common 25 - 32 1: Common

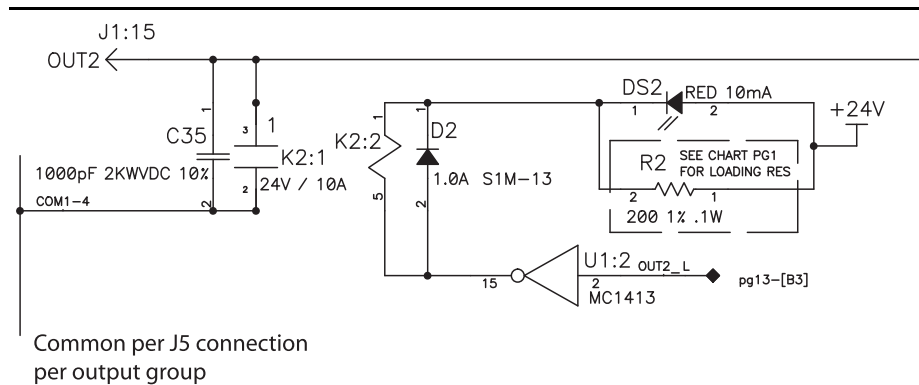
Figure 6.10 ICE-MOR Board



LED lights when corresponding output relay is active.

Active = Open
Active = Closed
Determined by iView settings according to user requirements.

Typical output circuit



ICE-RG Rope Gripper Board Quick Reference

The Rope Gripper board monitors and resets a rope gripper (emergency brake). The board is used in both AC and DC iControls.

Figure 6.11 ICE-RG Rope Gripper Board

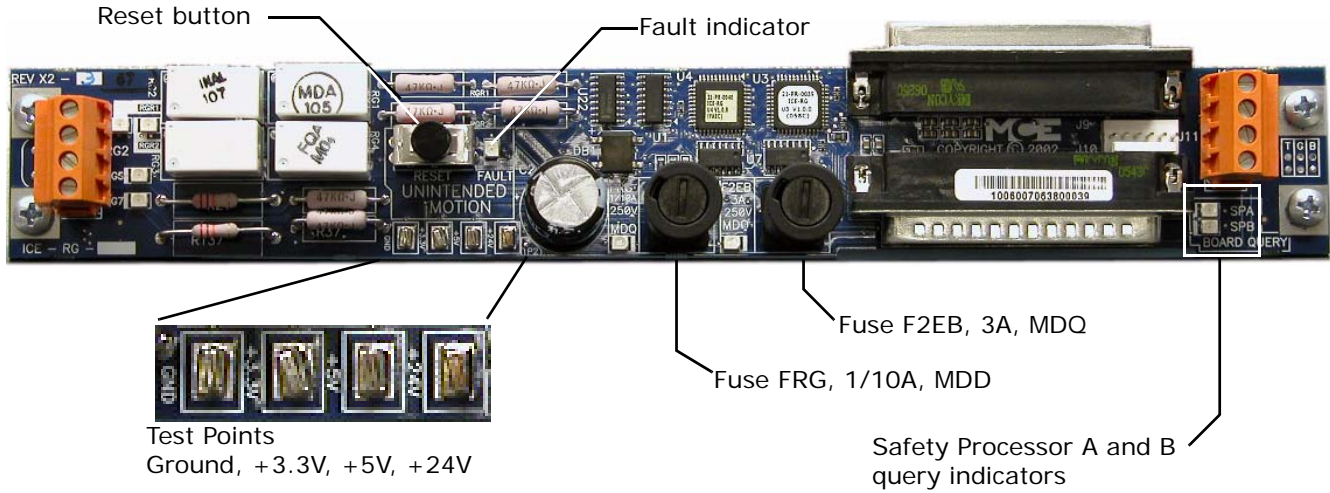


Table 6.21 Rope Gripper Board Connections

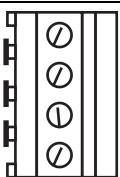

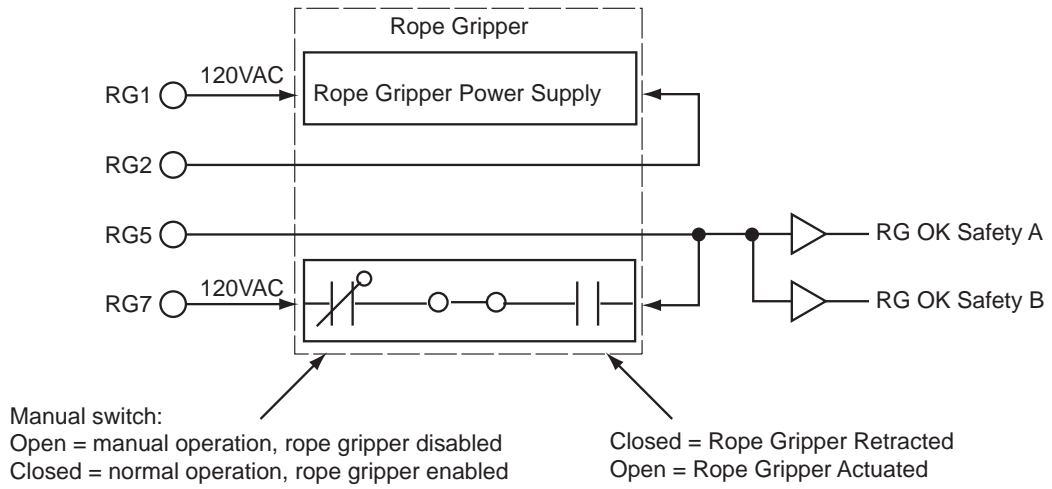
Connector	Signal	Connector	Signal
	RG1: 120VAC to RG power supply		1: Common
	RG2: RG power supply return		24x2: 18VAC in
	RG5: 120VAC=rope gripper OK 0V=rope gripper tripped		24: 18 VAC in
	RG7: 120VAC signal to rope gripper		2: 120VAC in

Figure 6.12 Simplified Rope Gripper Operation



ICE-SAF Safety Board Quick Reference

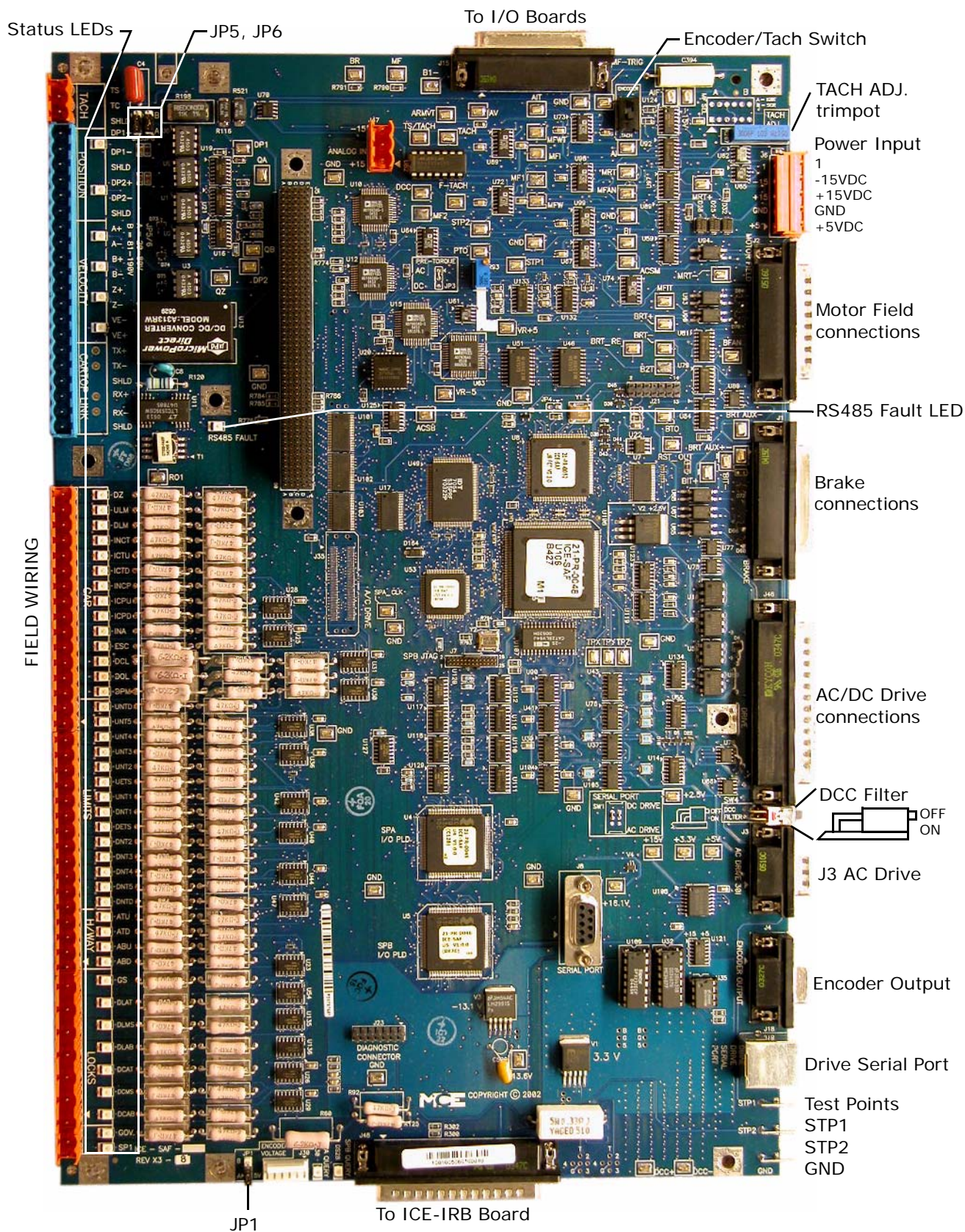


Table 6.22 ICE-SAF Board Jumper Table

Jumper	Setting	Description
JP1	A	Encoder Voltage. A = +5V, B = +15V
JP3	AC	Pre-Torque Filter (AC / DC): AC setting is hard wired, adds filtering to the pre-torque output.
JP5	B	Tach input range. A = 20-80V, B = 81-190V
JP6	B	Tach input range. A = 20-80V, B = 81-190V

Table 6.23 ICE-SAF Board Switches

Switch	Description
SW1	Serial Port switch: Setting for the Drive Serial Port (AC Drive / DC Drive). DC Drive setting hard wired.
SW2	Encoder / Tach: Encoder = AC drive with velocity encoder connected to AC drive. Tach = DC drive or AC drive with velocity encoder connected to iBox VELOCITY inputs.
SW4	DCC Filter (ON / OFF) Default = ON, adds filtering to Drive Current Command output.

Table 6.24 iBox Field Connections on ICE-SAF Board

Source	Connection	Signal Description
TACH	TS	Tach positive signal. Analog. 0 - 30 VDC (15 VDC @ 1000 RPM).
	TC	Tach common (negative in respect to TS when car moving down)
	SHLD	Tach shield connection (connect at iBox-end only)
POSITION	DP1+	Positive going, +15V, digital pulse stream from iLand to iLink to iBox (DP1 leads DP2 when car moves up). Please refer to "iLand Landing System" on page 3-2.
	DP1-	Negative going, -15V, digital pulse stream from iLand to iLink to iBox.
	SHLD	Shield connection for twisted-pair DP1+/DP1-
	DP2+	Positive going, +15V, digital pulse stream from iLand to iLink to iBox (DP2 leads DP1 when car moves down)
	DP2-	Negative going, -15V, digital pulse stream from iLand to iLink to iBox
	SHLD	Shield connection for twisted-pair DP2+/DP2-
VELOCITY ENCODER	A+	Positive going, +12V, digital pulse from motor velocity encoder. Please refer to "Velocity Encoder Installation and Wiring" on page 2-24.
	A-	Negative going, -12V, digital pulse from motor velocity encoder.
	B+	Positive going, +12V, digital pulse from motor velocity encoder.
	B-	Negative going, -12V, digital pulse from motor velocity encoder.
	Z+	Positive going, +12V, digital pulse from motor velocity encoder.
	Z-	Negative going, -12V, digital pulse from motor velocity encoder.
	VE-	Encoder power return
	VE+	+12 VDC power to encoder (relative to VE-)

Table 6.24 iBox Field Connections on ICE-SAF Board

Source	Connection	Signal Description
CARTOP LINK	TX+	iBox transmit, positive going serial communication stream from iBox to iLink. Connects to iLink ICE-CTP Board terminal RX+. TX+ and TX- comprise a differential communications pair. Please refer to "Installing iLink" on page 3-13.
	TX-	iBox transmit, negative going serial communication stream from iBox to iLink. Connects to iLink ICE-CTP Board terminal RX-.
	SHLD	Shield connection for twisted-pair TX+/TX-
	RX+	iBox receive, positive going serial communication stream from iLink to iBox. Connects to iLink ICE-CTP board terminal TX+. RX+ and RX- comprise a differential communications pair.
	RX-	iBox receive, negative going serial communication stream from iLink to iBox. Connects to iLink ICE-CTP board terminal TX-.
	SHLD	Shield connection for twisted-pair RX+/RX-
CAR	DZ	Door Zone Sensor input. Activated = 110 VDC.
	ULM	Up Leveling Marker Sensor input. Activated = 110 VDC.
	DLM	Down Leveling Marker Sensor input. Activated = 110 VDC.
	INCT	Cartop Inspection Station INSP/AUTO Switch input. Activated = 110 VDC.
	ICTU	Cartop Inspection Station UP Button input (includes SAF button). Activated = 110 VDC.
	ICTD	Cartop Inspection Station DN Button input (includes SAF button). Activated = 110 VDC.
	INCP	COP Inspection Station INSP/AUTO Switch input. Activated = 110 VDC.
	ICPU	COP Inspection Station UP Button input. Activated = 110 VDC.
	ICPD	COP Inspection Station DN Button input. Activated = 110 VDC.
	INA	Car Panel (Hoistway) Access Enable switch input. 0 VDC active signal level. Off = 110 VDC.
	ESC	Car Panel Emergency Stop switch input. 0 VDC active signal level stops car. Off = 110 VDC.
	DCL	Door Close Limit input. Door fully closed, input inactive, 0 VAC. Door not closed signal level, 120 VAC.
	DOL	Door Open Limit input. Door fully open, input inactive, 0 VAC. Door not open signal level, 120 VAC.
DPM	Door Position Monitor input. Door closed, input inactive, 120 VAC. Door not closed, 0 VAC.	

Table 6.24 iBox Field Connections on ICE-SAF Board

Source	Connection	Signal Description
LIMITS	UNTD	Up Normal Limit Direction switch input. 110 VDC = input on/switch closed. 0 VDC = input off/switch open.
	UNT5	Up Slowdown Limit switch #5 input. (see UNTD)
	UNT4	Up Slowdown Limit switch #4 input. (see UNTD)
	UNT3	Up Slowdown Limit switch #3 input. (see UNTD)
	UNT2	Up Slowdown Limit switch #2 input. (see UNTD)
	UETS	Up Emergency Terminal Limit switch input. (see UNTD)
	UNT1	Up Slowdown Limit switch #1 input. (see UNTD)
	DNT1	Down Slowdown Limit switch #1 input. (see UNTD)
	DETS	Down Emergency Terminal Limit switch input. (see UNTD)
	DNT2	Down Slowdown Limit switch #2 input. (see UNTD)
	DNT3	Down Slowdown Limit switch #3 input. (see UNTD)
	DNT4	Down Slowdown Limit switch #4 input. (see UNTD)
	DNT5	Down Slowdown Limit switch #5 input. (see UNTD)
	DNTD	Down Normal Limit Direction switch input. (see UNTD)
H/WAY	ATU	Hoistway Access Top Up switch input. When the Car Panel Access Enable switch (INA input) is on, an active input (key switch closure) here (110 VDC) will cause the car to move up the hoistway. A hoistway limit switch electrically between the ATU input and the activating switch will open and stop the car after it has moved the required distance up the hoistway (if installed). Normal/Off state = 0 VDC. Refer also to the -MRW drawing in the job prints.
	ATD	Hoistway Access Top Down switch input. When the Car Panel Access Enable switch (INA input) is on, an active input (key switch closure) here (110 VDC) will cause the car to move down the hoistway. A hoistway limit switch electrically between the ATD input and the activating switch will open and stop the car after it has moved the required distance down the hoistway (if installed). Normal/Off state = 0 VDC. Refer also to the -MRW drawing in the job prints.
	ABU	Hoistway Access Bottom Up switch input. When the Car Panel Access Enable switch (INA input) is on, an active input (key switch closure) here (110 VDC) will cause the car to move up the hoistway. A hoistway limit switch electrically between the ABU input and the activating switch will open and stop the car after it has moved the required distance up the hoistway (if installed). Normal/Off state = 0 VDC. Refer also to the -MRW drawing in the job prints.
	ABD	Hoistway Access Bottom Down switch input. When the Car Panel Access Enable switch (INA input) is on, an active input (key switch closure) here (110 VDC) will cause the car to move down the hoistway. A hoistway limit switch electrically between the ABD input and the activating switch will open and stop the car after it has moved the required distance down the hoistway (if installed). Normal/Off state = 0 VDC. Refer also to the -MRW drawing in the job prints.

Table 6.24 iBox Field Connections on ICE-SAF Board

Source	Connection	Signal Description
LOCKS/CONTACTS	GS	Gate Switch input. The gate switch makes up when the elevator doors close. When the switch is made, there will be 110 VDC on this input. When the switch is open, there will be 0 VDC on this input. The gate switch may be wired in series with other switches or locks on the elevator doors (as shown in the job prints) so that if any of the switches do not make, the GS input will remain low and the car will not run.
	DLAT	Door Lock Access Top input. When a top hoistway access is provided (see INA, ATU, and ATD), the hoistway door lock associated with that landing is connected between the #3 bus and this input. When the switch is made, there will be 110 VDC on this input. When the switch is open, there will be 0 VDC on this input and the car will not run unless INA is active and then only in response to the ATU or ATD input.
	DLMS	Door Lock Main String input. If top and bottom hoistway access (see INA, ATU, ATD, ABU, and ABD) is not provided, all hoistway door locks are wired in series between the #3 bus and DLMS. When the switches are made, there will be 110 VDC on this input. When any switch is open, there will be 0 VDC on this input and the car will not run.
	DLAB	Door Lock Access Bottom input. When a bottom hoistway access is provided (see INA, ABU, and ABD), the hoistway door lock associated with that landing is connected between the #3 bus and this input. When the switch is made, there will be 110 VDC on this input. When the switch is open, there will be 0 VDC on this input and the car will not run unless INA is active and then only in response to the ABU or ABD input.
	DCAT	Door Contact Access Top input. When a top hoistway access is provided (see INA, ATU, ATD, and DLAT), the hoistway door contact associated with that landing is connected between the #3 bus and this input. When the switch is made, there will be 110 VDC on this input. When the switch is open, there will be 0 VDC on this input and the car will not run unless INA is active and then only in response to the ATU or ATD input.
	DCMS	Door Contact Main String input. If top and bottom hoistway access (see INA, ATU, ATD, ABU, and ABD) is not provided, all hoistway door contacts are wired in series between the #3 bus and DCMS. When the switches are made, there will be 110 VDC on this input. When any switch is open, there will be 0 VDC on this input and the car will not run.
	DCAB	Door Contact Access Bottom input. When a bottom hoistway access is provided (see INA, ABU, ABD, and DLAB), the hoistway door contact associated with that landing is connected between the #3 bus and this input. When the switch is made, there will be 110 VDC on this input. When the switch is open, there will be 0 VDC on this input and the car will not run unless INA is active and then only in response to the ABU or ABD input.
	GOV	Governor input. The governor is connected between the #3 bus and this input. When the governor switch is made, there is 110 VDC on this input. If the governor switch trips/opens, there is 0 VDC on this input and the car will not run.
	SP 1	Spare input 1. If used, connect as shown in the job prints.

ICE-SF-x Serial Fixtures Board Quick Reference

The Serial Fixtures board is used in iControl elevator controllers to communicate with serial-control audible and visual indicators, e.g., voice annunciators or character displays. The board provides two identical outputs — one for hall displays and one for car displays. The “x” in the part number refers to the fixture type:

- CE = CE Electronics
- EM = E-Motive
- HJ = Hong Jiang

Figure 6.13 ICE-SF Serial Fixtures Board

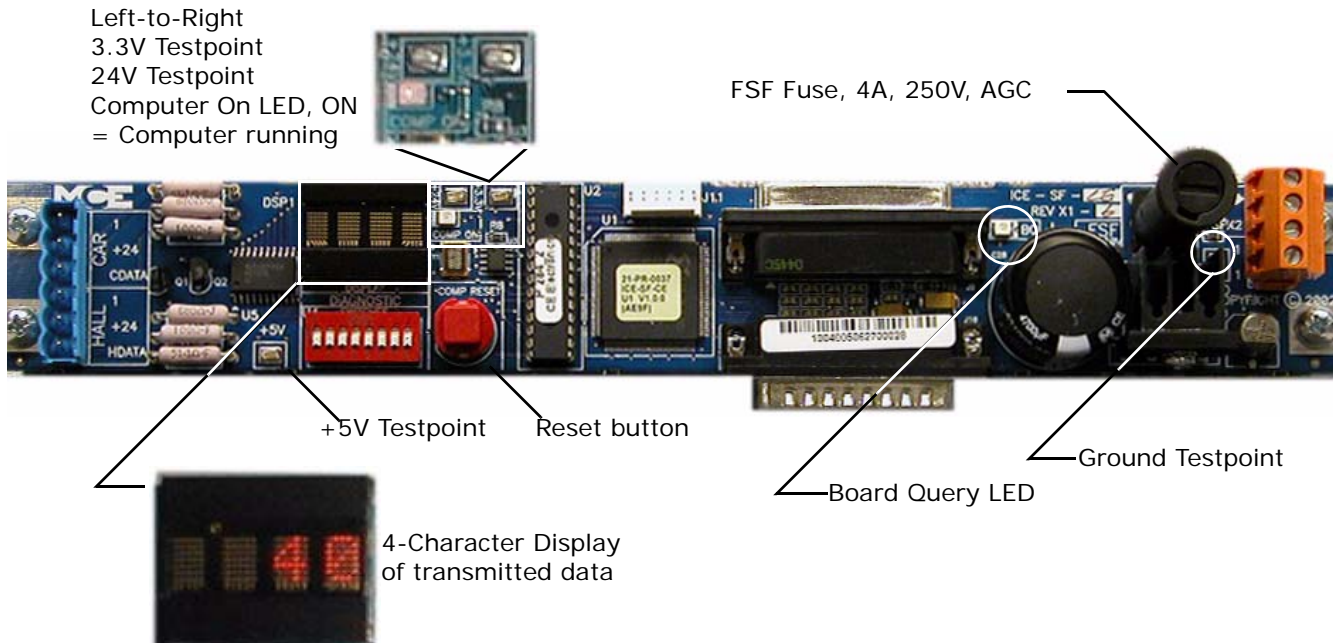


Table 6.25 Serial Fixture Board Connections

Connector	Signal	Connector	Signal
	1: Common		18VAC
	+24: 24VDC		18VAC
	CData: Data to car		1: Common
	1: Common		1: Common
	+24: 24VDC		
	HData: Data to hall		

SC-HCDA-ISO Serial Hall Call Driver Isolation Board QR

The SC-HCDA-ISO Serial Hall Call Driver Isolation Board is used on iControl AC and DC Simplex and Swing car controllers. The isolation board is placed between the SC-HCDA Serial Hall Call Driver (usually mounted inside the iPower Box) and the Serial Hall Call Input on the right side of the iBox. Revision 6.0 and later of the ICE-IMP board incorporates the isolation circuitry thereby eliminating the need for the SC-HCDA-ISO. [Please refer to “Serial Hall Call” on page 5-30](#) for additional information.

Figure 6.14 SC-HCDA-ISO Serial Hall Call Driver Isolation Board



SC-HCE-ME Serial Hall Call Ethernet - Digi ME Board QR

The SC-HCE-ME Serial Hall Call Ethernet board is used to convert signals from the SC-HCDA Serial Hall Driver Assembly to Ethernet for transmit and receive via the 2 = SYSTEM bus. The -ME indicates that the Digi Connect ME device is being used on this board.

Figure 6.15 SC-HCE-ME Serial Hall Call Ethernet - Digi ME Board

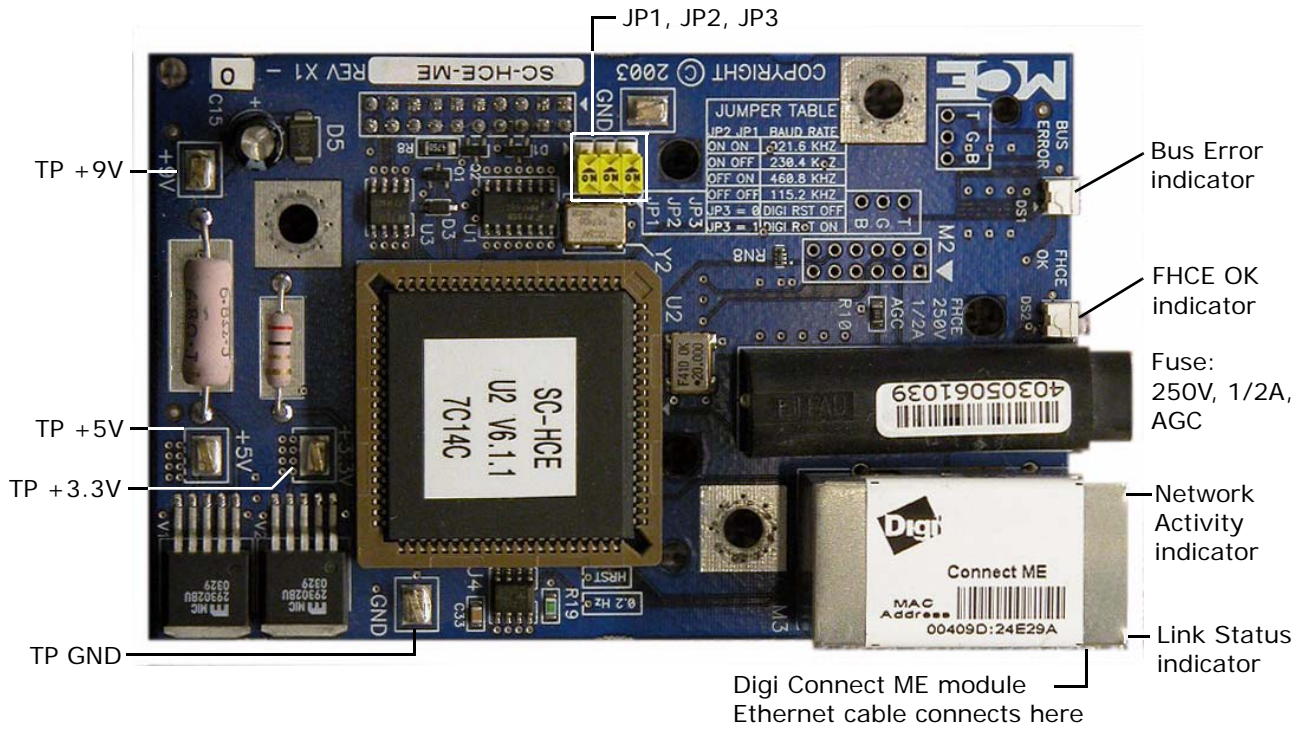


Table 6.26 SC-HCN-ME Indicators

Indicator	Description
Bus Error	ON = Communication problem
FHCE OK	ON = Power to the board and fuse OK
Link Status	Yellow indicator, ON = Network link is operational.
Network Activity	Green indicator, ON = Network traffic detected.

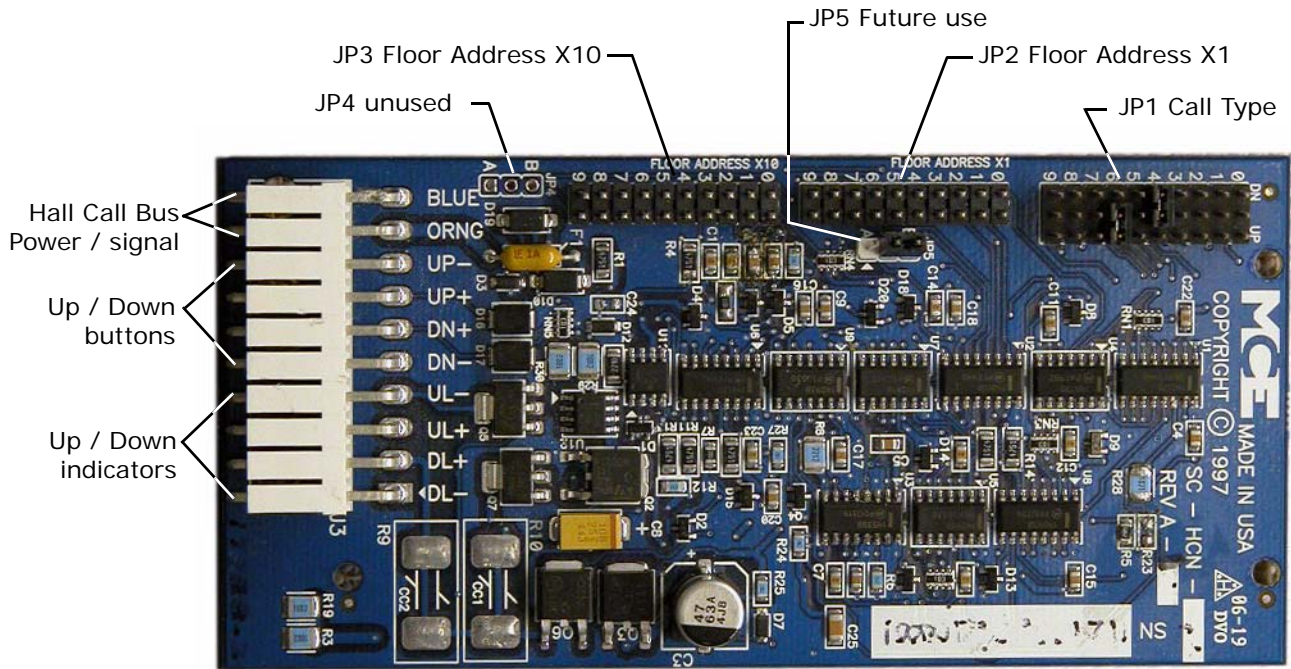
Table 6.27 SC-HCN-ME Jumpers

JP1	JP2	JP3	Description
OFF	OFF		115kHz baud rate (default setting)
OFF	ON		230.4 kHz baud rate
ON	OFF		460.8 kHz baud rate
ON	ON		921.4 kHz baud rate
		OFF	Board address cannot be changed (default setting)
		ON	Board address can be programmed

SC-HCN Serial Hall Call Node Board Quick Reference

In a typical installation, an SC-HCN Serial Hall Call Node board is mounted in each hall call fixture enclosure. Please refer to “Hall Call Installation” on page 5-32. The board provides two outputs to power the hall call lamps or LEDs, two inputs for the hall call buttons, and jumpers to set the floor ID and hall call “type”.

Figure 6.16 SC-HCN Serial Hall Call Node Board



For more information on setting the node board addresses, see “Setting Node Board Addresses” on page 5-33.

SC-ION: Serial Control I/O Board Quick Reference

One or more SC-ION boards may be used in an iCentral group controller. The SC-ION board provides a communications interface between discrete signal level or relay-oriented field equipment and the serial communications bus used by iCentral for serial hall call and other serial messaging. Inputs and outputs on the SC-ION board are assigned unique serial addresses at the factory according to customer requirements. Using iView, customers can view the function assigned to each address and may even assign a different (MCE-supported) function if their needs change. Each SC-ION board provides 16 user-configurable inputs and 16 user-configurable outputs.

I/O Connections

Connect inputs and outputs as shown in your job prints. SC-ION board inputs are always 117VAC. Outputs may be configured (in specific groups) to provide either a path to ground or current to drive indicator lamps/LEDs.

Output State Selection The outputs are divided into three groups. Each group shares a common. The common may be wired to provide a current source or a path to ground. The groups are:

- Relays 1 – 4
- Relays 5 – 8
- Relays 9 – 16

The commons for the groups are determined by the connections made to board connector J4. The appropriate connections are determined during the job survey. Each system is configured before shipment. You need only connect the inputs and outputs as shown on the job prints.

Board Addresses Each of the 16 inputs and 16 outputs on the board has an address on the system bus. The addresses are assigned as indicated by the job survey before the system is shipped. A software tool, running on a Windows platform, is used to set individual addresses and also to set the address range (10-489 or 10-989) used for the job. To configure the board, a Windows PC running the software tool must be connected to the board serial port.

Figure 6.17 SC-ION Serial Control I/O Board

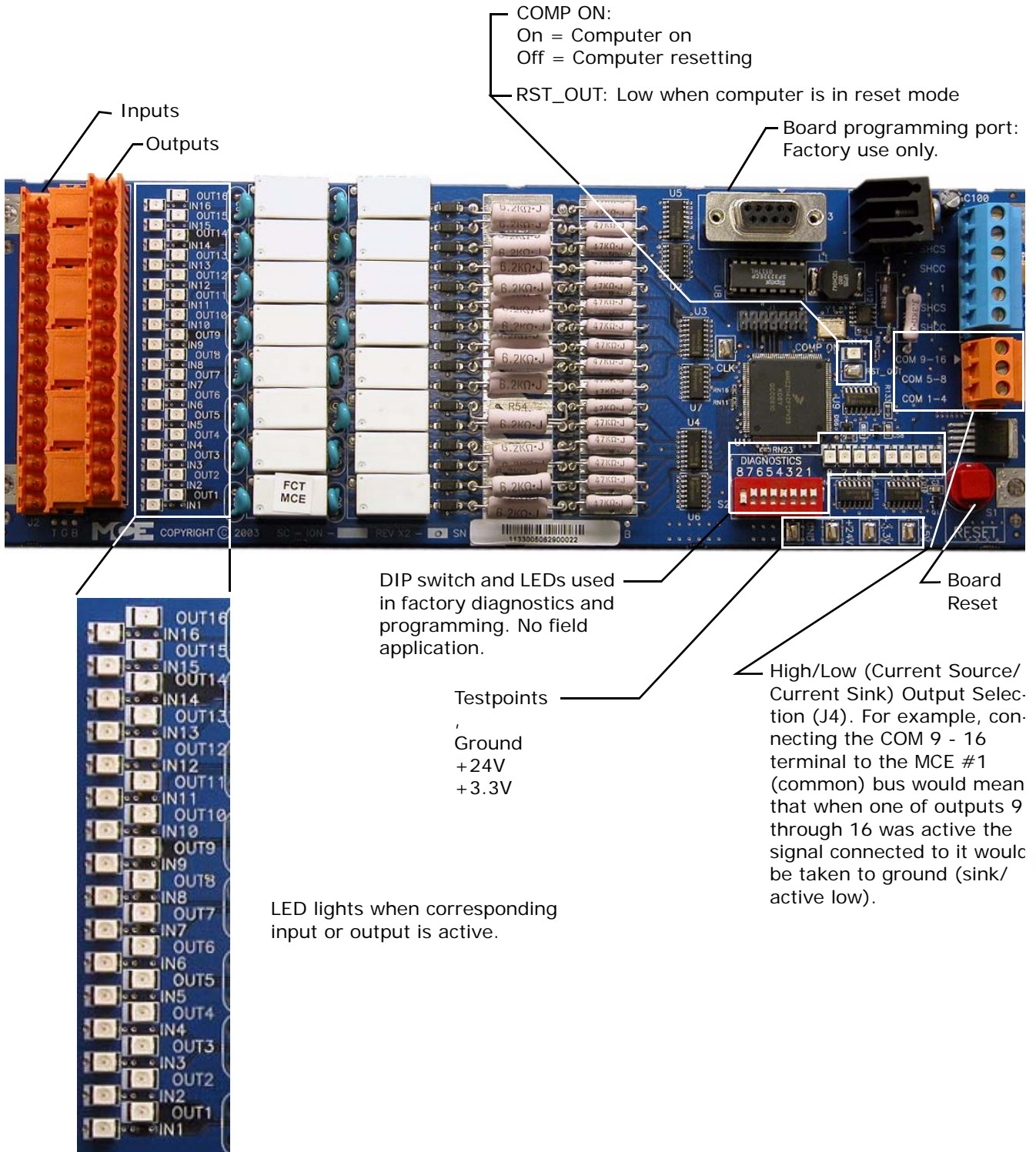
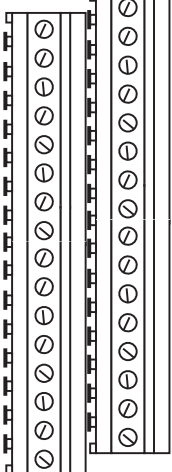
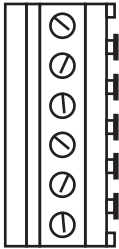



Table 6.28 SC-ION Board Inputs and Outputs

Connector	Signal	Connector	Signal
	In 1-16: 117VAC when active		1: Common
	Out 1-16: Determined by common connection		SHCS: Serial signal, +/-15V bit stream
			SHCC: Serial signal, common
			1: Common
			SHCS: Serial signal, +/- 15V bit stream
			SHCC: Serial signal, common
			COM 9-16: Connect to select active output for outputs 9-16.
			COM 5-8: Connect to select active output for outputs 5-8.
			COM 1-4: Connect to select active output for outputs 1-4.



Quick Topics

- About the Front Panel
- LCD Display and Keypad
- Setting iBox Ethernet
- System Status Display
- System Control Switches



iBox Front Panel Controls



About the iBox Front Panel

System status indicator LEDs and function control switches are accessible on the iBox front panel. The front panel also provides:

- LCD display and entry keypad (see [page 7-3](#)).
- Access to iBox Ethernet Port addresses (see [page 7-9](#)).
- System-level diagnostic LED display (see [page 7-11](#)).
- System function control switches (see [page 7-12](#)).

Front panel controls allow you to:

- Directly view and adjust iBox configurable parameters (see [page 7-3](#)).
- Quickly ascertain system status (see [page 7-11](#)).
- Access Controller mode and other function switches (see [page 7-12](#)).

The following illustration shows iBox front panel controls.

Figure 7.1 *iBox*



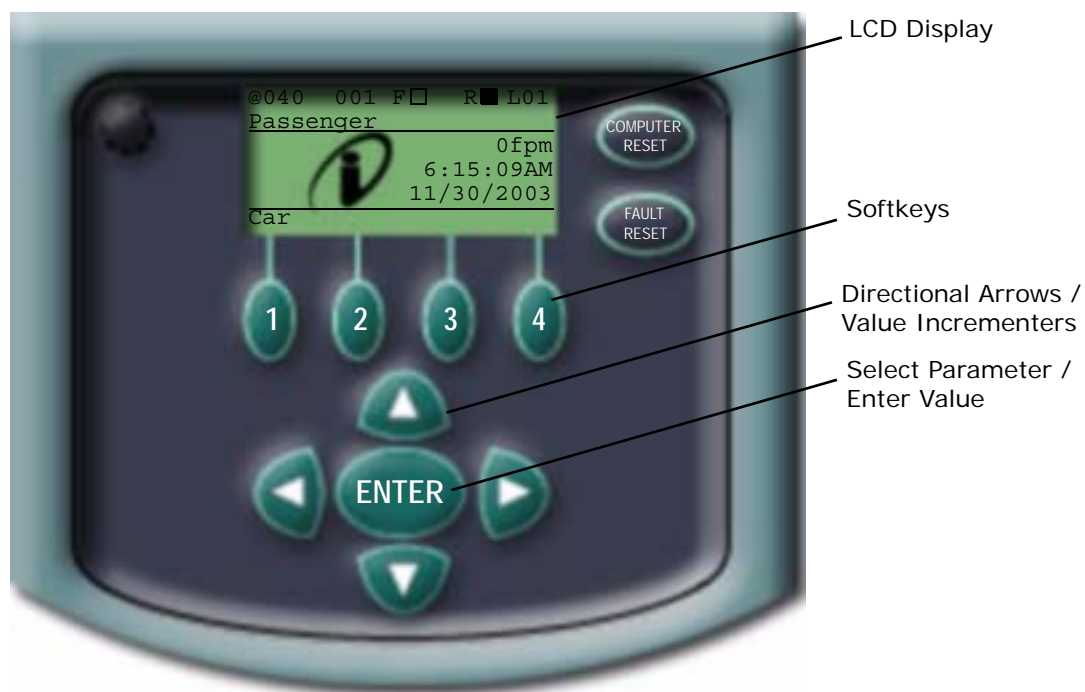
LCD Display and Keypad

The iBox LCD display and keypad allow you to:

- View and change parameter settings
- View and register calls
- View the status of inputs, outputs, and flags
- View error messages and the system event log

Typically, when you need to view or change parameters in an iControl, you connect to the iBox through the PC or LAN ethernet port and use the iView graphical user interface running on a Windows OS PC to easily access, view, or edit any desired parameter. However, during initial system setup when setting the parameters that allow PC access to your system, or when a PC is not available, some parameters can be directly accessed and edited through the keypad and LCD display located on the front panel of every iBox.

Figure 7.2 iBox Data Entry Keypad and LCD Display



Keypad Controls

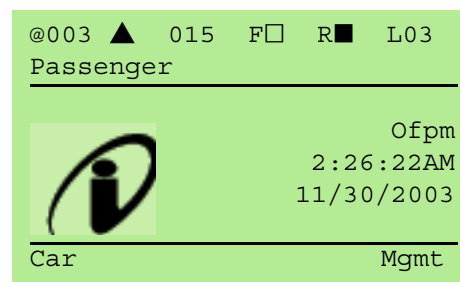
Keypad controls include:

- Display Contrast — adjusts the LCD display
- Computer Reset — resets the iBox computers
- Fault Reset — initializes the fault list
- Softkeys — selects the associated topic across the bottom of the LCD display
- Up Arrow — moves the selection bar up or increases a parameter value
- Down Arrow — moves the selection bar down or decreases a parameter value
- Left Arrow — moves the cursor left (digit selection)
- Right Arrow — moves the cursor right (digit selection)
- ENTER — confirms a selection or enters a parameter value

LCD Display

The LCD display allows you to view iBox parameters. The top line of each display “screen” provides a status “snapshot” for the car associated with the controller. In our example:

- @ (door zone) —
 - @: in door zone
 - -: below door zone
 - +: above door zone
- 003 — current floor
- ▲ or ▼ (direction arrows)
- 015 — next floor
- F (front doors) —
 - Open
 - Closed
 - Opening/Closing
 - Invalid door position
- R (rear doors) —
 - Open
 - Closed
 - Opening/Closing
 - Invalid door position
- S or L (Simplex or Local)
- 03 (Car ID)



The second line of the display shows the mode of operation (Passenger in the example) displayed in rotation with any active status or error messages. If a soft key is pressed (Car or Mgmt) the remaining display lines change to display appropriate information. The labels in the bottom line change to indicate the function of their associated soft key.

Parameter Entry

To edit or view a parameter, you select a broad topic by pressing the Enter soft key, then select and view or edit a parameter. For example, to change or edit a Car-associated parameter.

1. Press the soft key (1) beneath the Car label. The LCD will change as shown to the right.
2. Use the arrow keys to scroll to a topic.
3. With the topic selected (Network Setup in our example), press ENTER.

```
@003 ▲ 015 F□ R■ L03
Passenger
Network Setup
View Event Log
View/Register Calls
Set Time/Date
View Factory Data
Home Back PgUp PgDn
```

Note that the soft key labels have changed:

- Home — Returns you to the home screen.
 - Back — Takes you back one screen.
 - PgUp — When there are more topics than can be listed on a single screen, PgUp moves you up the list a full “screen” at a time.
 - PgDn — When there are more topics than can be listed on a single screen, PgDn moves you down the list a full “screen” at a time.
4. Use the arrow keys to scroll to a topic.
 5. With the topic selected, press ENTER.

When you press ENTER, the display updates.

6. Use the arrow keys to scroll to a topic.
7. With the topic selected, press ENTER.

When you press ENTER, the display updates. The cursor/arrow indicates a parameter can be edited.

8. Use the left/right arrow keys to position the arrow below the number to be changed.
9. Use the up/down arrow keys to increment or decrement the value.
10. Repeat positioning and incrementing/decrementing as necessary. Press ENTER to enter the new value.
11. The soft key labels will indicate Save and Cancel. Press Save to save your changes after a yes or no acknowledgement.

or,

12. Press Cancel to leave the screen without saving your changes (after a yes or no acknowledgement).

Editing a Controller Parameter

To edit a parameter:

1. Navigate to the desired screen.
2. Edit the parameter.
3. Save the edited parameter.

The following illustration shows which parameter groups are accessible on the Car and Mgmt menu LCD screens. Use the illustration and Table 6.1 to help you locate a parameter to be adjusted.

Figure 7.3 Onboard Diagnostics Car Menu Tree

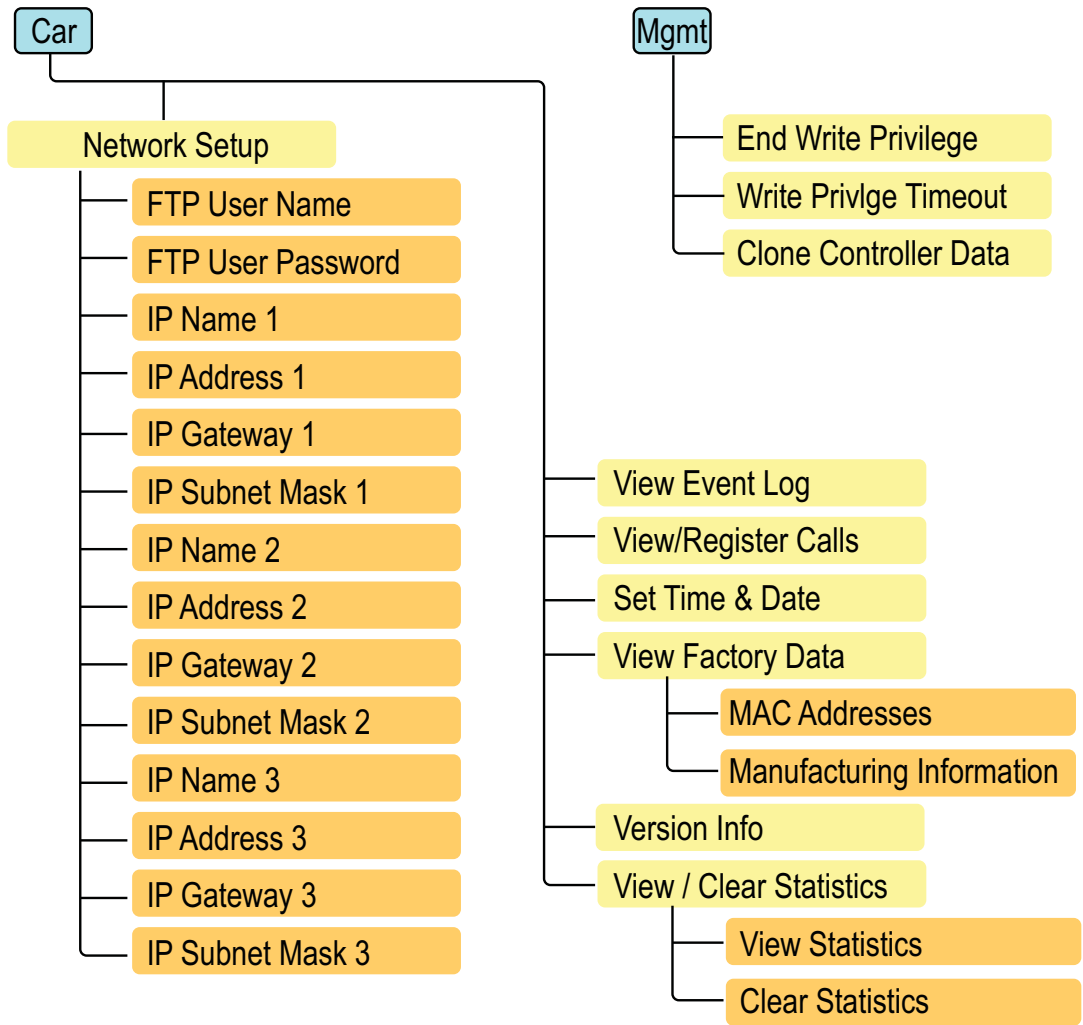


Table 7.1 Car Menu Parameters

Car Menu Parameters
Network Setup
<p>There are three Ethernet ports on the iBox. #1 is the Local Area Network connection used to connect Group and Elevator controllers to your Local Area Network. #2 is the MCE equipment connection used to interconnect Group and Elevator controllers for equipment control purposes. #3 is the PC Direct connection used to connect a PC directly to a Controller for immediate access. Network setup parameters allow the IP information to be set for each of the three ports. Additionally, an FTP User Name and Password must be set here without which the File Transfer Protocol server may not be accessed.</p> <p>There are many websites that are helpful in learning about TCP/IP.</p>
<p>To set the FTP User Name: Enter a User Name that must be employed to access the FTP server.</p>
<p>To set the FTP User Password: Enter a password that must be employed to access the FTP server.</p>
<p>To set the IP Name 1: Enter a name for the #1 port. This is the peripherals port used for local area network connection, typically for networked PCs running iView.</p>
<p>To set the IP Address 1: Enter an address for the #1 port. Please refer to "System, LAN, & 3=PC TCP/IP Addresses" on page 7-9.</p>
<p>To set the IP Gateway 1: Enter a gateway address for the #1 port. Please refer to "System, LAN, & 3=PC TCP/IP Addresses" on page 7-9.</p>
<p>To set the IP Subnet Mask 1: Enter a subnet mask address for the #1 port. Please refer to "System, LAN, & 3=PC TCP/IP Addresses" on page 7-9.</p>
<p>To set the IP Name 2: Enter a name for the #2 port. This is the system port used to connect to the hub that supports MCE controllers, serial hall call, etc.</p>
<p>To set the IP Address 2: Enter an address for the #2 port. Please refer to "System, LAN, & 3=PC TCP/IP Addresses" on page 7-9.</p>
<p>To set the IP Gateway 2: Enter a gateway address for the #2 port. Please refer to "System, LAN, & 3=PC TCP/IP Addresses" on page 7-9.</p>
<p>To set the IP Subnet Mask 2: Enter a subnet mask address for the #2 port. Please refer to "System, LAN, & 3=PC TCP/IP Addresses" on page 7-9.</p>
<p>To set the IP Name 3: Enter a name for the #3 port. This is the PC port, meant for direct connection to a PC running iView using a standard Ethernet cable and NO HUB.</p>
<p>To set the IP Address 3: Address for the #3 port. Default at 192.168.193.1.</p>

Table 7.1 Car Menu Parameters

Car Menu Parameters
<p>To set the IP Gateway 3: Enter a gateway address for the #3 port. Please refer to “System, LAN, & 3=PC TCP/IP Addresses” on page 7-9.</p>
<p>To set the IP Subnet Mask 3: Enter a subnet mask address for the #3 port. Please refer to “System, LAN, & 3=PC TCP/IP Addresses” on page 7-9.</p>
<p>View Event Log</p>
<p>View Event log accesses the event database maintained by the controller. This database lists messages by ID Number, ordered by time-of-occurrence. Additional data is also stored, e.g. Type, Date, Time, Acknowledgement Status, and Event (name) for each event. A listing of iBox Event Log ID Numbers and a cross-reference to iControl Messages and descriptions can be found in Section 6 of this User Guide. Please refer to “Cross Reference: iBox Event Log ID Numbers to iControl Messages ” on page 6-4 and see “iControl Messages” on page 6-13</p>
<p>To view the Event Log: Press softkey (1) beneath the <i>Car</i> label, scroll down to <i>View Event Log</i> and press Enter. To view event details, scroll to the desired event and press Enter. <i>Scroll down to see all of the data, including the event name.</i></p>
<p>View/Register Calls</p>
<p>The View/Register Calls dialog allows you to send transport commands to the controller.</p>
<p>To View/Register Calls: Allows you to enter car and hall calls for Front or Rear Car Operating Panels.</p>
<p>Set Time/Date</p>
<p>This parameter sets the real time clock for the controller.</p>
<p>To set the Set Time/Date: Enter the current time and date for use by the controller real time clock.</p>
<p>View Factory Data</p>
<p>View Factory Data accesses serial number, date, and MAC address information for the controller. This information is very useful should you ever have to contact MCE about your equipment.</p>
<p>MAC Addresses: A six-byte, unique, identifying code used by LANs to positively identify communicating equipment. This parameter allows you to view the MAC address for each of the three Ethernet ports.</p>
<p>Manufacturing Info: View the controller serial number, revision, and ICE-IMP information.</p>
<p>Version Info</p>
<p>Version Info provides version information for the software currently installed on your controller.</p>
<p>Version Info: View the software version information for the controller and car top processors.</p>
<p>View / Clear Statistics</p>
<p>View and/or clear statistical data collected by the controller. The statistical data includes the odometer, power-up cycles, front and rear door cycles, motion cycles, floor time, floor runs, inspection runs, auto runs, and auto relevels.</p>

Table 7.2 Mgmt Menu Parameters

Mgmt Menu Parameters
<p style="text-align: center;">End Write Privilege</p> <p>Use to cancel write privilege which has been granted to an iView PC connected to the controller.</p>
<p style="text-align: center;">Write Privlge Timeout</p> <p>Use to change the write privilege timeout timer setting. The default value is 15 minutes.</p>
<p style="text-align: center;">Clone Controller Data</p> <p>This option is used for field replacement of an iBox. It allows the controller's parameter settings to be saved to flash memory. That memory can then be transferred to the new iBox, thus eliminating the need to manually enter and learn the parameter settings. Specific instructions for using this feature are provided with the replacement iBox.</p>

Setting iBox Ethernet Port Addresses

The table below lists the factory default addresses TCP/IP addresses. The iBox 3 = PC port (PC direct) is set to 192.168.193.001 and should not be changed.

Table 7.3 System, LAN, & 3=PC TCP/IP Addresses

Hub	Group	Group IP, Primary & Backup	Car ID	Car IP	System/Serial Hall Call Bus 1 - 4	iView PC
System	all	192.168.192.201-202	1-20	192.168.192.001-020	192.168.192.211-214	
LAN	A	192.168.191.201-202	1-20	192.168.191.001-020		192.168.192.101-200*
LAN	B	192.168.191.203-204	1-20	192.168.191.021-040		
LAN	C	192.168.191.205-206	1-20	192.168.191.041-060		
LAN	D	192.168.191.207-208	1-20	192.168.191.061-080		
LAN	E	192.168.191.209-210	1-20	192.168.191.081-100		
Port #3 = PC (iBox ONLY), NO HUB				192.168.193.001		

*192.168.191.101 is typically used for the iView PC.

The default Subnet Mask for all ports is 255.255.255.000.

The default Gateway for the #1 (LAN or Peripheral Port) is 192.168.191.254.

The default Gateway for the #2 and #3 ports is 000.000.000.000.

You should not need to change the factory-set IP information. If you are having problems connecting to an iBox Ethernet port, refer to the following topic to verify and, if necessary, set IP addresses.



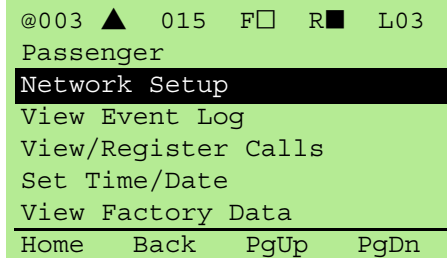
Note

The Group ID setting in iView determines the iCue System IP address at which iCue will accept messages. **NO NOT set the Group ID to a setting other than 1** unless instructed to do so by MCE. Group IDs other than 1 are reserved for future use and will cause group-to-car communication to fail. If you need advanced System addressing information, please contact MCE.

IP Address Verification/Setting

You should not need to change the factory-set IP information. If you are having problems connecting to an iBox Ethernet port, verify that IP information is correct as described here. If you find an incorrectly set port, these instructions will help you correct it. These instructions are for Port 1 but the procedure is the same for all iBox ports.

1. Press the soft key (1) beneath the Car label. The LCD will change as shown to the right.
2. With Network Setup selected, press ENTER.
3. Scroll down to IP Address 1, press ENTER.
4. Verify that the Address displayed is correct (see preceding table). For example, Car A of Group 1 should be 192.168.191.001.
5. If you are using the default addresses, and the address displayed is incorrect, set it according to the table using Left and Right arrow keys to select a number and Up and Down arrow keys to change the value. Continue until the address is correct, then press ENTER. Press SAVE to save your changes (if any).
6. Scroll down to IP Gateway 1. The default for the #1 Port is 192.168.191.254. (The default for the #2 and #3 Ports is 000.000.000.000) If necessary, change it as described above.
7. Scroll down to IP Subnet Mask 1. The default is 255.255.255.000. If necessary, change as described above.
8. Continue as above to verify the IP information for the #2 and #3 Ports respectively. Check the preceding table for factory default addresses.



@003 ▲ 015 F□ R■ L03
Passenger
Network Setup
View Event Log
View/Register Calls
Set Time/Date
View Factory Data
Home Back PgUp PgDn

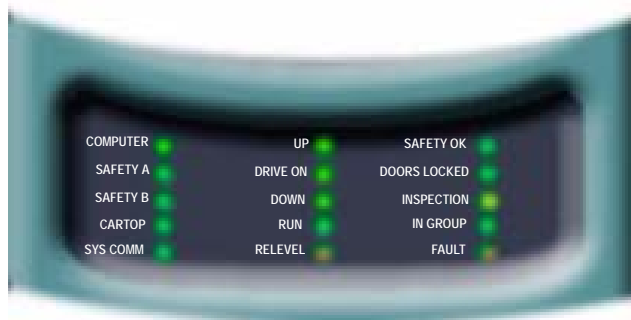
System Status Display

iBox front panel LEDs and the LCD display both provide status information.

LED Status Display

The LEDs of the front panel display provide immediate controller status information:

- **Computer:** Lights green when the controller microprocessor is running properly.
- **Safety A:** Lights green when Safety System A is functioning properly.
- **Safety B:** Lights green when Safety System B is functioning properly.
- **Car Top:** Lights green when the Cartop microprocessor is running properly.
- **Sys Comm:** Lights green when controller is communicating with Group.
- **Up:** Lights amber when car is moving up.
- **Drive On:** Lights amber when drive has control of car. Drive On may be ON while UP and DOWN are OFF indicating no movement but drive is holding zero speed.
- **Down:** Lights amber when car is moving down.
- **Run:** Lights green when car is making a run between floors. Remains off during re-leveling operations.
- **Relevel:** Lights red when car is releveling.
- **Safety OK:** Lights green when safety path is made up.
- **Doors Locked:** Lights green when doors are locked.
- **Inspection:** Lights amber when car is on Cartop, In-Car, Machine Room, or Hoistway Access Inspection.
- **In Group:** Lights green if car is able to respond to group hall call demand.
- **Fault:** Lights red if one or more system faults are active.

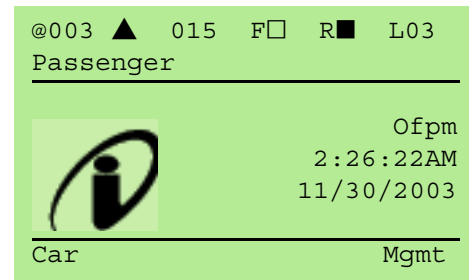


Note

These displays are frequently used when the elevator controller is being configured. Please refer to Sections 3 and 4 of this guide for use descriptions.

LCD Status Display

The LCD screen displays text messages advising of system status. The second line of the display shows the mode of operation (Passenger in the example) displayed in rotation with any active status messages. [Please refer to “iControl Messages” on page 6-13](#) for description.

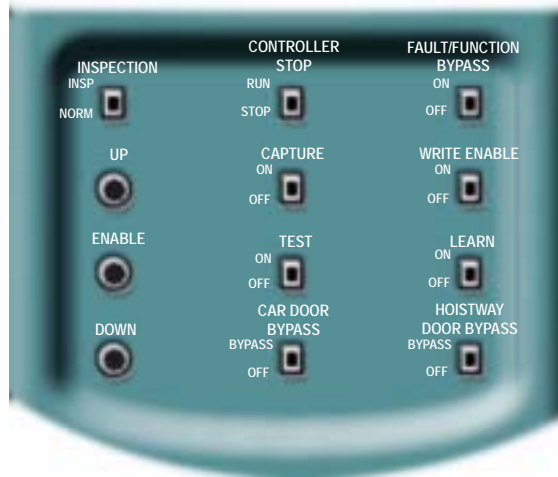


System Control Switches

The front panel system control switches allow you direct access to system functions including:

- **Inspection:** Switch used to place the car on Machine Room Inspection (Insp) or Normal operation (Norm).
- **Up:** Push switch used to run the car up when the system is on Machine Room Inspection and the Enable button is simultaneously pressed and held.
- **Enable:** Push switch used to run the car up or down when the system is on Machine Room Inspection and the Up or Down button is simultaneously pressed and held.
- **Down:** Push switch used to run the car down when the system is on Machine Room Inspection and the Enable button is simultaneously pressed and held.
- **Controller Stop:** Switch used to immediately remove hoist motor and brake power (Stop) or apply power to those systems (Run).
- **Capture:** Switch used to place Car on Capture operation (On). While this switch is On, the car will not respond to hall call demand or Parking.
- **Test:** Switch used to place the car on Test Mode operation (On).
- **Fault/Function Bypass:** Switch to allow specific faults and safety functions (as determined by Keypad/LCD settings) to be bypassed. Car must be in Test mode.
- **Write Enable:** (Factory only) Switch used to allow special data to be saved (On).
- **Learn:** Switch used to confirm intended Learn operation. The learn procedure must be selected. For Hoistway Learn, the car must be on Inspection mode. For Terminal Switch Learn, the car must be on Test mode.
- **Car Door Bypass:** Switch used to bypass the car door electric contacts (Bypass position). When set to Bypass, the car will run only on Inspection mode. The ability to set this bypass must be enabled at the factory and is only available if allowed by safety regulations in your area. Check the iView Safety Configuration screen to see if the feature is enabled in your installation.

- **Hoistway Door Bypass:** Switch used to bypass the hoistway door electric contacts (Bypass position). When set to Bypass, the car will run only on Inspection mode. The ability to set this bypass must be enabled at the factory and is only available if allowed by safety regulations in your area. Check the iView Safety Configuration screen to see if the feature is enabled in your installation.



 **Note**

These control switches are used when the elevator controller is being configured. Please refer to Sections 3 and 4 of this guide for use descriptions.

Safety Bypass Jumper and Fuses

The iBox provides four fused outputs:

- 120v/60Hz AC: Fuses F2 and F2PI.
- 110v DC: Fuses F3 and F3HA.
- 120v/60Hz AC: Motor Drive. Fuse F2D.
- 120v/60Hz AC: Motor Contactor. Fuse F2MC.

When installed, the Safety Bypass jumper electrically connects the SB and 3 terminals on the IRB Relay Board. Information about the Safety Bypass jumper is in Section 6 of this guide (see [“Safety String Bypass Jumper” on page 6-3](#)).

7



Danger

The fuses and the bypass jumper expose dangerous high voltages that can cause bodily harm or death. **ONLY TRAINED, AUTHORIZED PERSONNEL** should have access to these areas.





Quick Topics

- [About *iVIEW*](#)
- [How *iVIEW* Works](#)
- [Getting Started](#)
- [Working Online](#)
- [Working Offline](#)
- [iVIEW Windows](#)
- [Resizing Windows](#)
- [Unpinning Windows](#)
- [Undocking Windows](#)
- [Printing Screens](#)
- [Setting Date / Time](#)
- [Edit Graphic Displays](#)



Using *iVIEW*



About *iVIEW*

iVIEW is a graphical user interface running on a Windows PC or laptop computer. The computer may be connected directly to the iBox PC Ethernet port or, through a Local Area Network, to the iBox LAN ethernet port. Using *iView*, you can quickly and easily:

- [View and adjust all user-configurable controller parameters](#) (see [page 8-17](#)).
- Diagnose performance issues — on location, from a remote site, or both.
- [Work in an offline file, then upload data to a controller](#) (see [page 8-23](#)).

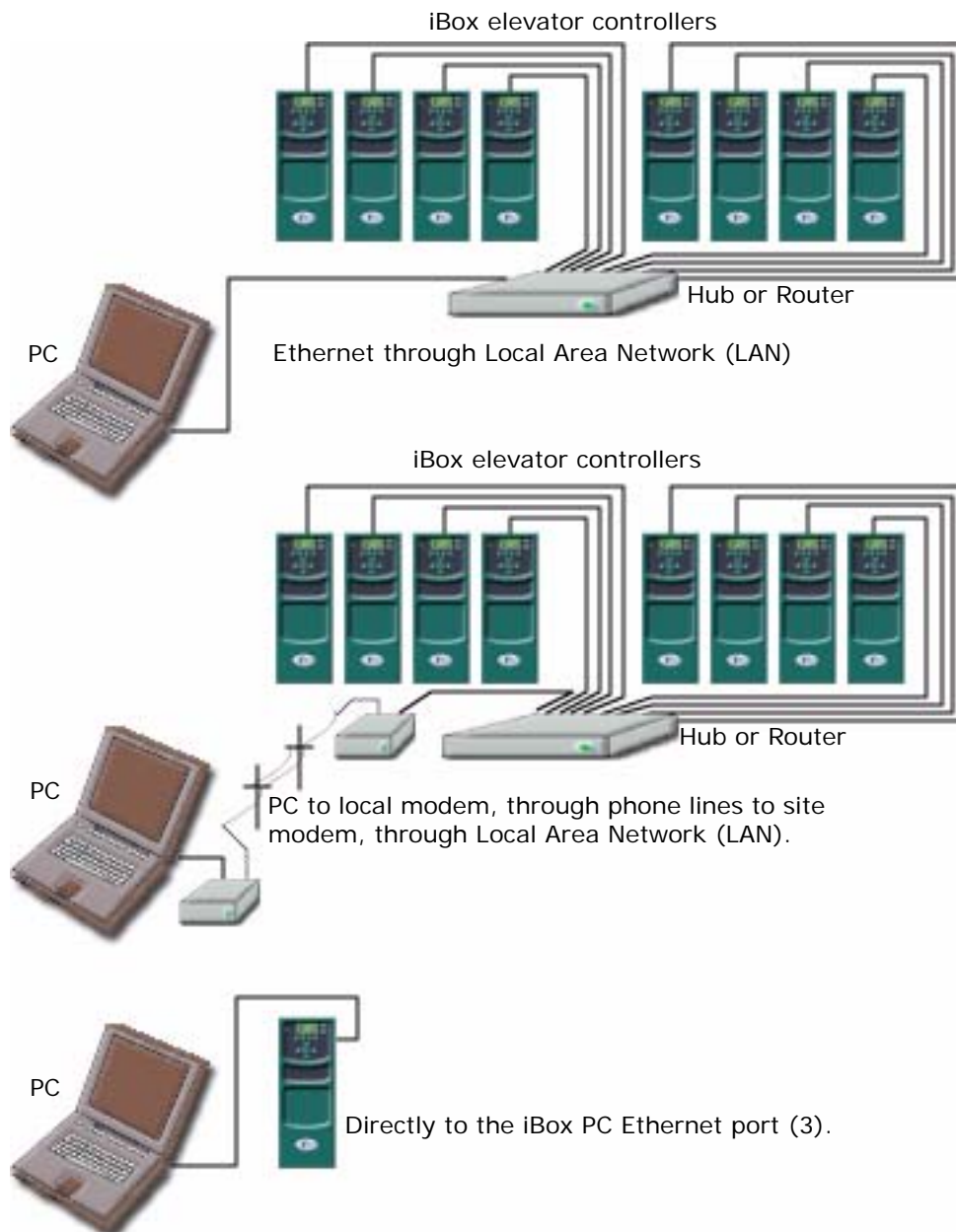
This section provides a detailed description of *iView*. *iView* on-line Help provides even greater detail and is updated whenever a software revision is released. This section contains:

- **How *iView* Works** (see [page 8-2](#))
- **Getting Started** (see [page 8-4](#))
- **LAN Connections** (see [page 8-13](#))
- **Working Online** (see [page 8-17](#))
- **Saving Parameters to a Configuration File** (see [page 8-20](#))
- **Saving Default Parameters to a Configuration File** (see [page 8-21](#))
- **Loading Parameters from a Configuration File** (see [page 8-22](#))
- **Working Offline** (see [page 8-23](#))
- **Accessing Online Help** (see [page 8-24](#))
- **iView Windows and Tabs** (see [page 8-25](#))
- **Resizing Windows & Docking/Undocking Windows** (see [page 8-34](#) & [page 8-35](#)).

How iView Works

iView software runs on any PC using the Windows 2000 or later operating system. iView communicates with a controller through an Ethernet connection and loads operating parameters stored on the controller into iView screens. The iView user can view virtually any controller parameter and can edit/adjust any user-configurable parameter, then send changed parameters to the controller.

Because iView communicates with elevator controllers through an Ethernet connection, a single PC can be used to administer multiple elevators or even multiple groups of elevators (with each group operating under the direction of a group dispatcher). Elevator adjusters who service multiple sites will find it convenient to connect directly to a controller, then easily upload proven settings from a file on their hard drive to the controller. The diagram below illustrates just a few of the ways Ethernet connectivity allows iView to communicate with elevator controllers.



Installing iView

If you purchased your iView PC from MCE, iView was installed at the factory. If not, you will need to install iView from a CD-ROM or other source. Minimum requirements for the iView PC are:

- At least 1GB free hard drive space for installation
- Minimum 256MB RAM
- Windows 2000 or XP operating system
- CD-ROM drive
- 10/100 Ethernet capable
- Simple text or comparable text editing software

These instructions assume familiarity with personal computers. To install iView:

1. Insert the iView CD-ROM in the computer CD-ROM drive.
2. Launch the CD.
3. Double-click the ReadMeFirst (or other accompanying text file) to review the latest iView instructions.
4. Double-click on the Setup.exe application.
5. Follow on-screen instructions to install iView.

After installation, the iView icon will appear on your desktop



Getting Started

There are two ways to connect the iBox to a PC:

- **Direct Connection:** Connect the PC directly to the iBox through the iBox 3 = PC port.
- **Peripheral LAN Connection:** Connect the PC to the LAN hub supporting one or more iBox controllers (iBox 1 = LAN port). (This hub is part of the iCue/iCentral installation.)

Connections are stored in the iControl Connections folder. To make a LAN connection, you launch iView, click File > Connection > Open and double-click the connection you wish to open. If the connection has not yet been created, you will need to create it as described in this section before you can connect to the controller. [Please refer to “Creating a New LAN Connection” on page 8-13](#) if you need to create a connection. When entering addresses on a PC, do not use leading zeros, i.e., .020 is entered as .20. (When entering IP addresses through the iBox keypad, leading zeros are required.)

About LANs: LAN stands for Local Area Network. A LAN is basically several computers (or smart equipment with a computer inside — like the iBox or iCue) all connected at a common point (the hub) so they can communicate with each other. In order for a message from one computer to reach the computer (or iCue/iBox) it wants to talk to, all the computers connected to the LAN have to have their own unique address. The address is called a TCP/IP number. The table below lists iControl default IP addresses. Your job prints provide specific instructions as to how all of your IP addresses are set.

Table 8.1 System, LAN, & 3=PC TCP/IP Addresses

Hub	Group	Group IP, Primary & Backup	Car ID	Car IP	System/Serial Hall Call Bus 1 - 4	iView PC
System	all	192.168.192.201-202	1-20	192.168.192.001-020	192.168.192.211-214	
LAN	A	192.168.191.201-202	1-20	192.168.191.001-020		192.168.191.101-200*
LAN	B	192.168.191.203-204	1-20	192.168.191.021-040		
LAN	C	192.168.191.205-206	1-20	192.168.191.041-060		
LAN	D	192.168.191.207-208	1-20	192.168.191.061-080		
LAN	E	192.168.191.209-210	1-20	192.168.191.081-100		
Port #3 = PC (iBox ONLY), NO HUB				192.168.193.001		

*192.168.191.101 is typically used for the iView PC.

The default Subnet Mask for all ports is 255.255.255.000.

The default Gateway for the #1 (LAN or Peripheral Port) is 192.168.191.254.

The default Gateway for the #2 and #3 ports is 000.000.000.000.

Note

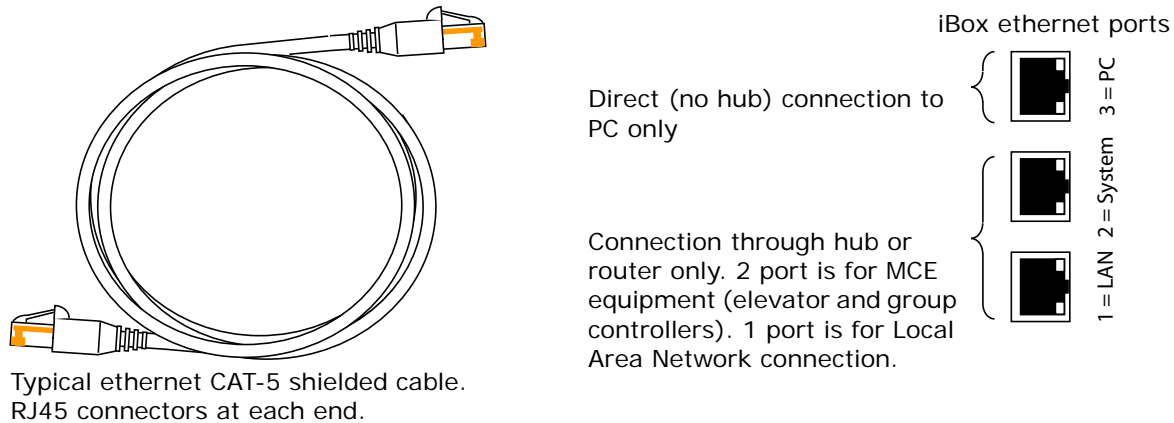
The Group ID setting in iView determines the iCue System IP address at which iCue will accept messages. **NO NOT** set the Group ID to a setting other than 1 unless instructed to do so by MCE. Group IDs other than 1 are reserved for future use and will cause group-to-car communication to fail. If you need advanced System addressing information, please contact MCE.

Direct Connections

Unless a Local Area Network (Ethernet) hub has already been installed, you will find it easiest to connect a PC to the iBox using the 3 = PC port on the iBox (direct connection). To make a direct connection:

1. Connect the iView PC to the controller 3 = PC port using only a standard Ethernet cable. **(Do not connect the #3 port through a hub or router.)**

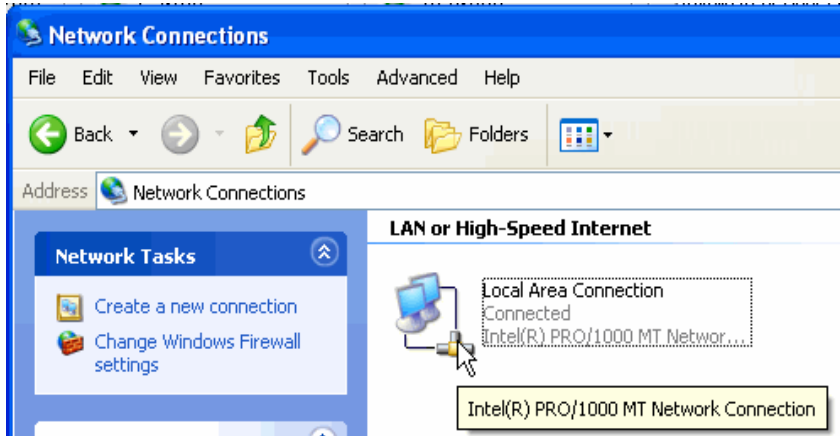
Figure 8.1 Ethernet Cable and iBox Ethernet Ports



Note

The iBox 3 = PC Ethernet port address, gateway, and mask are set to default values by MCE. If you have used your PC to connect to other iBoxes, you probably only need to connect the cable, launch iView, and select the connection with the appropriate IP information and use that to connect. When creating direct connections in the iView connections folder, it is a good practice to name them clearly so they are easy to distinguish (i.e., “CarA Direct”). The instructions here are intended to help a first-time user make a direct Ethernet connection between a PC and the iBox. [Please refer to “System and LAN Ethernet” on page 11-15](#) for more detail.

2. Start the PC.
3. From the Windows XP *Start* menu, click *Control Panel*.
4. Double click *Network and Internet Connections* to open the Network and Internet Connections dialog.
5. Double click *Network Connections* to open the Network Connections dialog.
6. Double-click the *Local Area Connection icon* to open the Local Area Connection Status dialog.

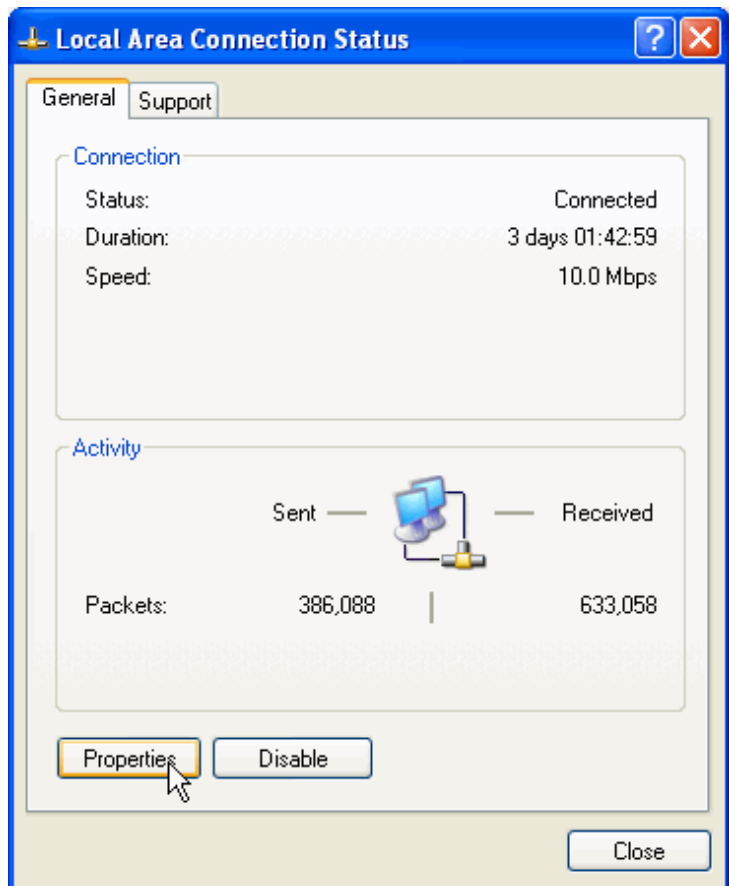


7. Click *Properties* to open the Local Area Connection Properties dialog.

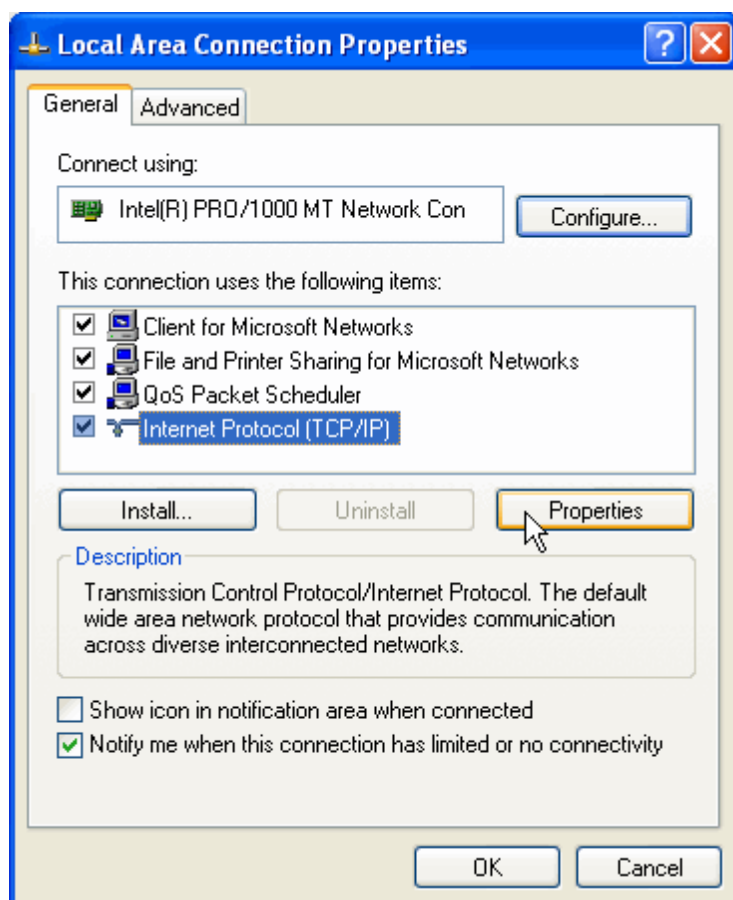


Note

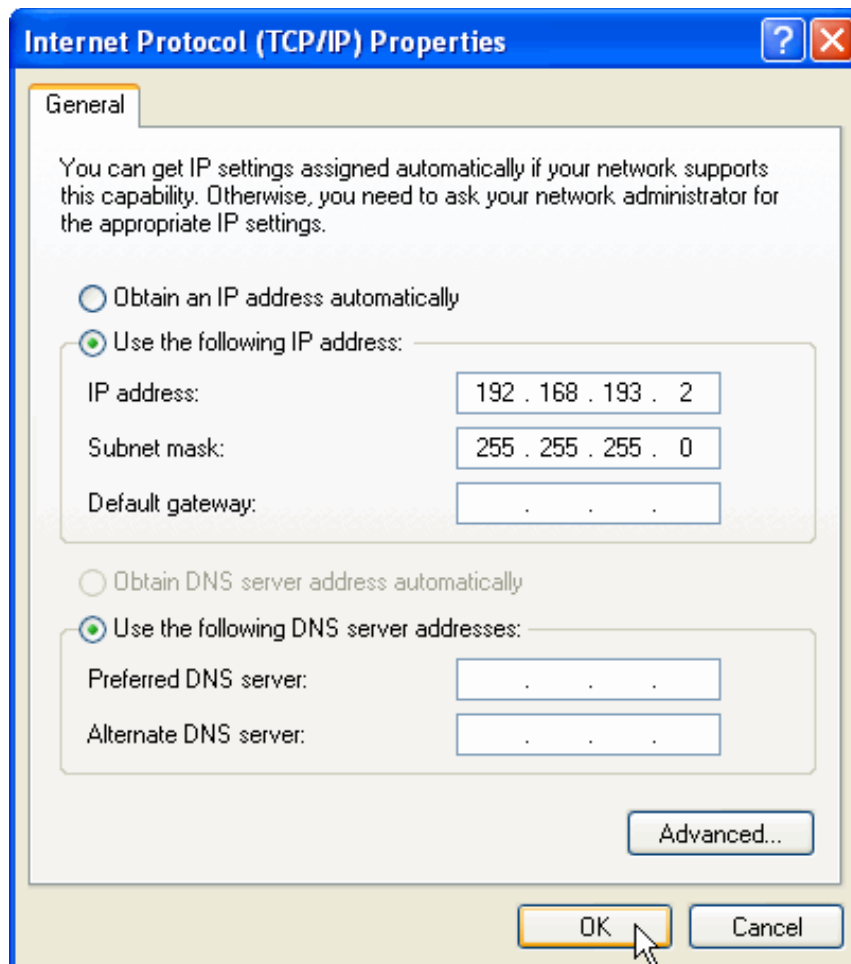
Sample screens are Windows XP™ operating system.



8. In the Local Area Connection Properties dialog, select *Internet Protocol (TCP/IP)*.
9. Click *Properties* to open the Internet Protocol (TCP/IP) Properties dialog.



10. Set the IP Address to match the iBox EXCEPT FOR the last set of numbers. The #3 iBox port is defaulted to 192.168.193.1. Typically, you can set your PC's IP address to 192.168.193.2.



11. Set the Subnet Mask to 255.255.255.0.
12. Click OK and follow any instructions to save the changes you made.

**Note**

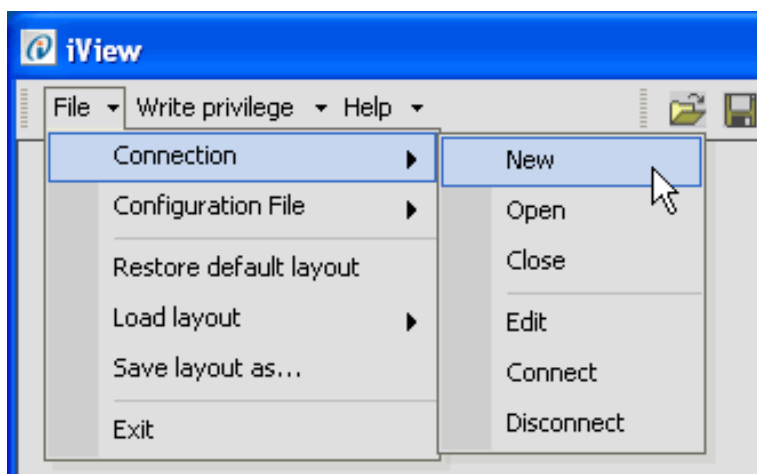
Sample screens are Windows XP™ operating system.

**Note**

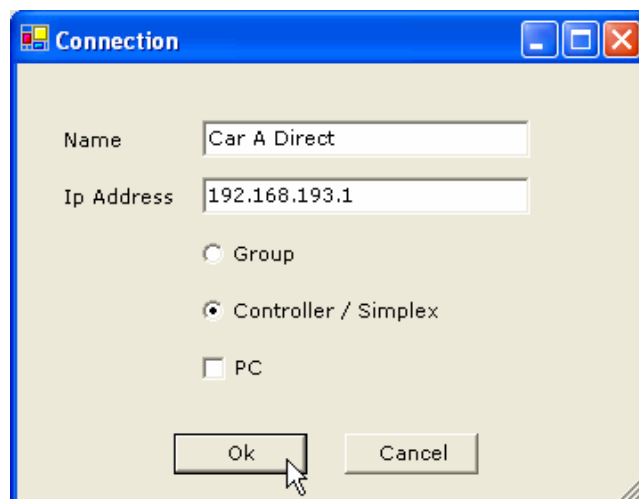
It is important that the PC have only one IP address assigned. Click the *Advanced* button and verify that the PC is configured for only a single IP Address (192.168.193.2). If there is more than one IP Address, highlight the additional IP Address and then click *Remove*.

Creating a Direct Connection in iView Once you have set your computer TCP/IP as described previously, you need to create a connection in iView.

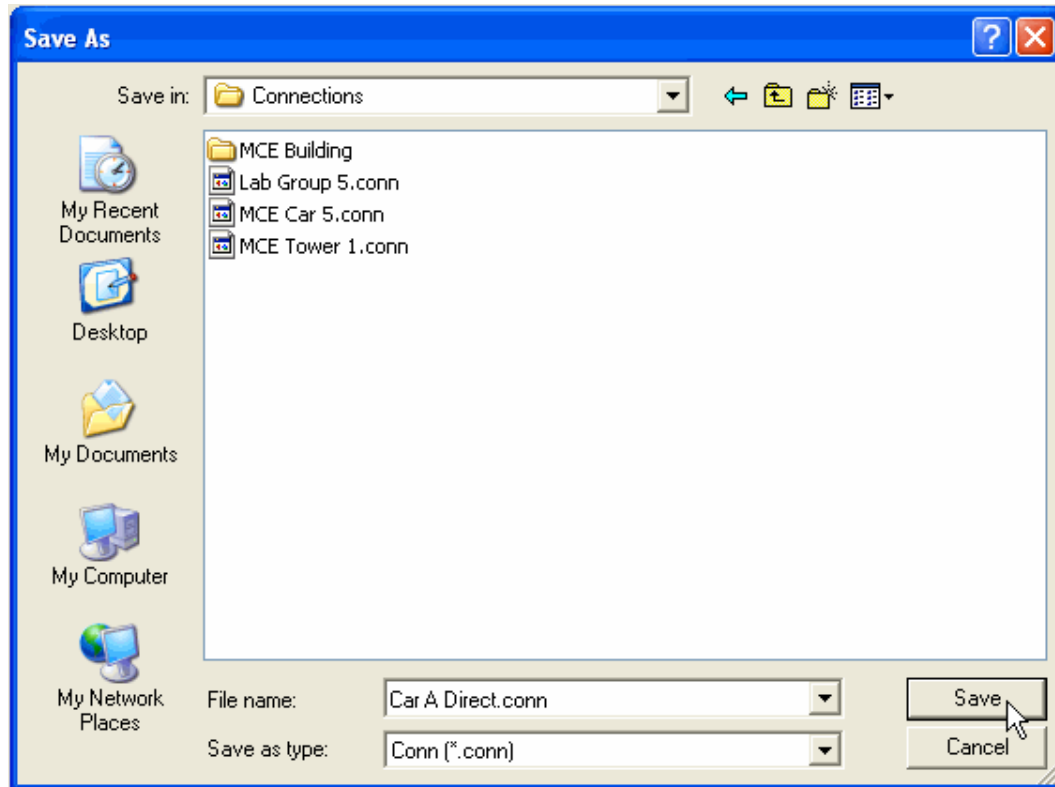
1. Double-click on the iView icon on your computer screen to launch iView.
2. Click *File* on the menu bar.
3. Select *Connection* and click *New* to open the Connection dialog.




4. Type in a name for the connection.
5. Enter the direct connection IP Address for the iBox (192.168.193.1).
6. Select *Controller/Simplex*.
7. Click *OK*. The Save As dialog opens.

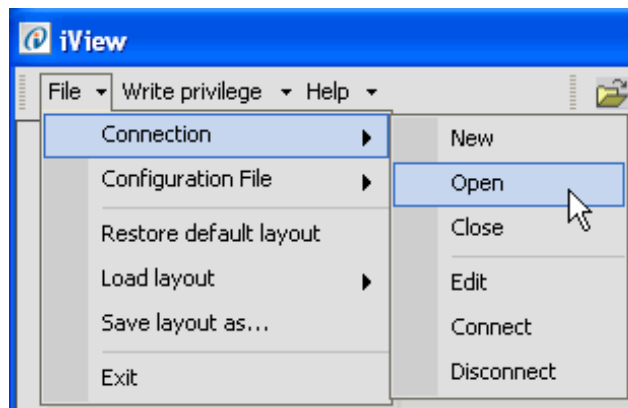


8. Enter a *File name* for this connection in the Save As dialog.
9. The suggested (default) location for connections is the *Connections* folder (My Documents > Motion Control Engineering > iView > Connections). You may choose another location using standard windows methods. You may also create sub-folders inside the iController Connections folder in which groups of connections can be stored.
10. Click *Save* to save the connection.

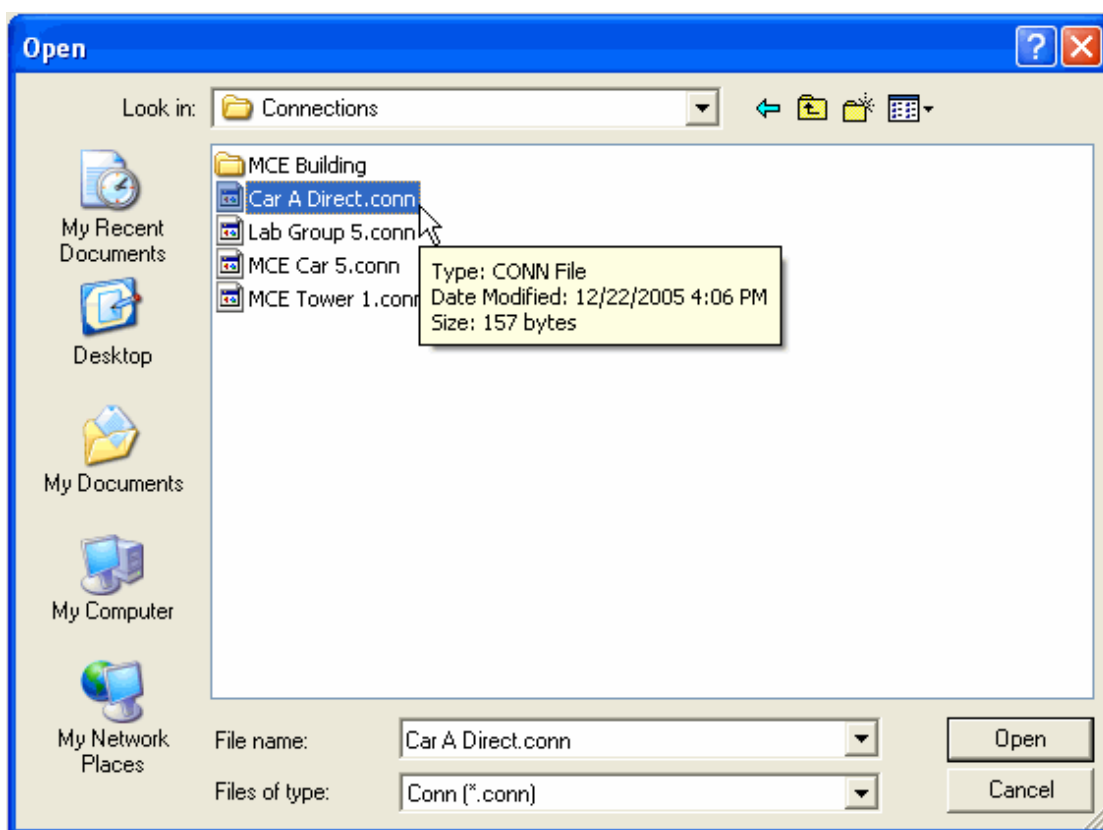


Connecting to the iBox Once the connection is created and saved, you are ready to connect.



1. Click the *Open Connection* button 
2. or click *File* on the menu bar, select *Connection* and click *Open*. The Open dialog appears.



3. To connect to a controller, double click the desired connection or select the connection and click Open.





4. When iView is communicating with a controller, this symbol  is displayed in the bottom left corner of the iView screen.
5. When iView is not communicating with a controller, this symbol  is displayed in the bottom left corner of the iView screen.
6. When the connection is established, the Operational Status tab and Hoistway window are displayed.

The screenshot displays the iView software interface for MCE Car 5. The main window is titled "iView | MCE Car 5" and includes a menu bar (File, Write privilege, View, Help) and a toolbar with icons for Controller and System. The "Operational Status" tab is active, showing several data panels:

- Speed:** Commanded 0 fpm, Actual 0 fpm, Motor 0 rpm.
- Processor health:** Safety A, Safety B, and Cartop, all indicated by green lights.
- In-service:** Safety OK, System comm, and In group, all indicated by green lights.
- Motion:** Cmd direction (black square), Actual direction (white square), and Category (AutoIdle).
- Position:** Logical 170.016 ft, Actual 170.016 ft, and Cartop 13563.39 ft.
- Leveling sensor:** Front and Rear sections with Up and Down leveling markers and Door zones, all indicated by green lights.
- Machine:** Mode (Stop), Arm voltage (-0.18 Vrms), Arm current (0.01 Arms), Field voltage (38.28 Vrms), Field current (0.10), Brake voltage (0.47 Vdc), and Brake current (0.03).
- Door Lock:** Front and Rear, both indicated by green lights.
- Pattern:** Profile (Idle) and Phase (Idle).

On the right side, the "Hoistway" window shows a vertical scale from 98,000 to 206,000 feet. A car icon is positioned at approximately 170,000 feet. The window also displays "Passenger" information with a count of 15 and "Speed" and "Load" indicators with color-coded scales. The bottom status bar shows "Local (Alternate Dispatcher)" and the date/time "12/15/2008 11:41:05 AM".

LAN Connections

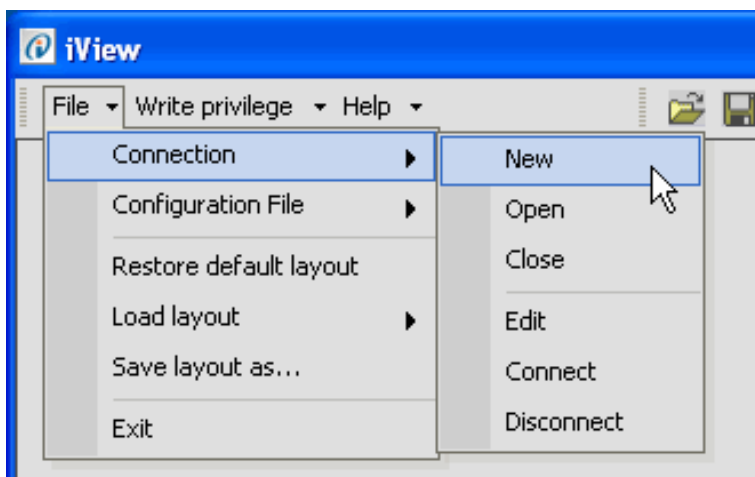
In most installations, there will be at least one iView PC continuously connected to the Local Area Network on which the iBox controllers reside. LAN TCP/IP addresses and associated settings for any hubs, routers, or other equipment involved are resolved when network equipment is installed. In these instances, the iView PC is already connected through the network to the controllers.

Creating a New LAN Connection

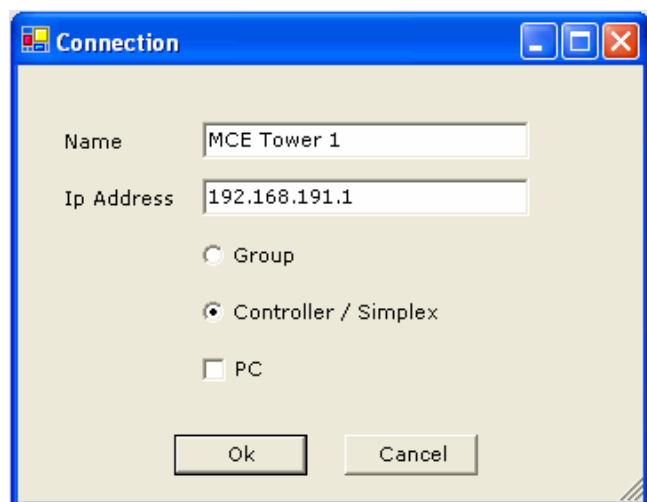
A controller connection must be created before it appears in the iView Connections folder. This is typically completed at the factory, before the system is shipped (if your PC was purchased through MCE). Creating a new LAN connection is similar to creating a new Direct connection.

To create a LAN connection:

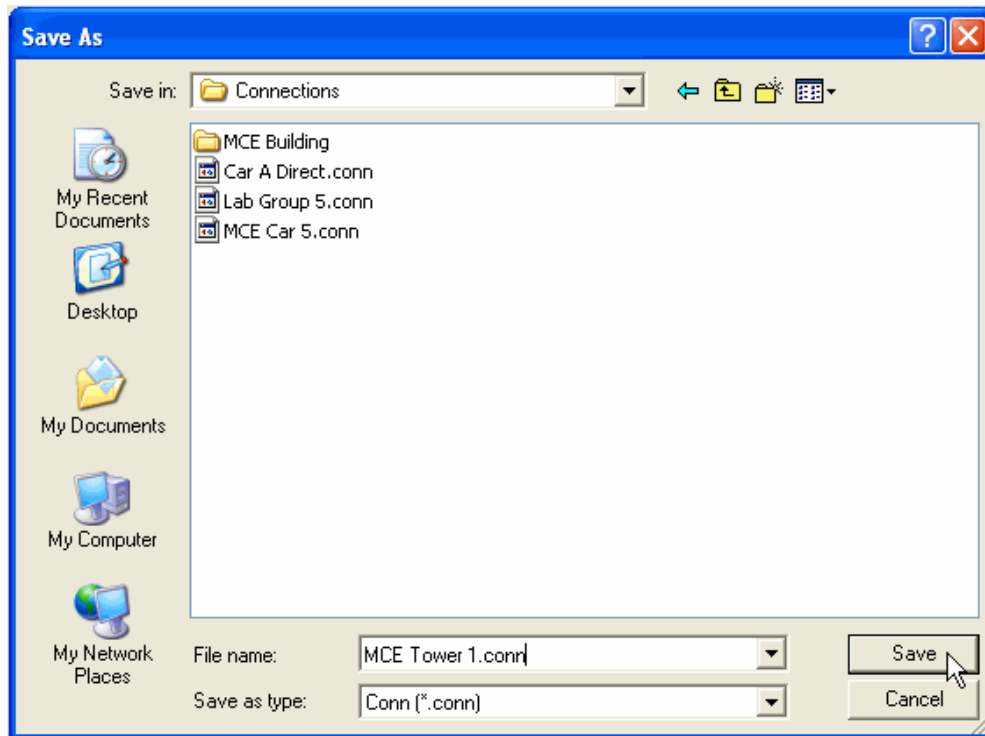
1. Double-click on the iView icon on your computer screen to launch iView.
2. Click *File* on the menu bar.
3. Select *Connection* and click *New* to open the Connection dialog.




4. Type in a name for the connection.
5. Enter the Ip Address, the controllers #1 (LAN) Ethernet port address. The site network administrator should have this information for you. [Please refer to “System, LAN, & 3=PC TCP/IP Addresses” on page 8-4](#) for the factory default settings.
6. Select *Controller/Simplex*.
7. Click *OK*. The Save As dialog opens.

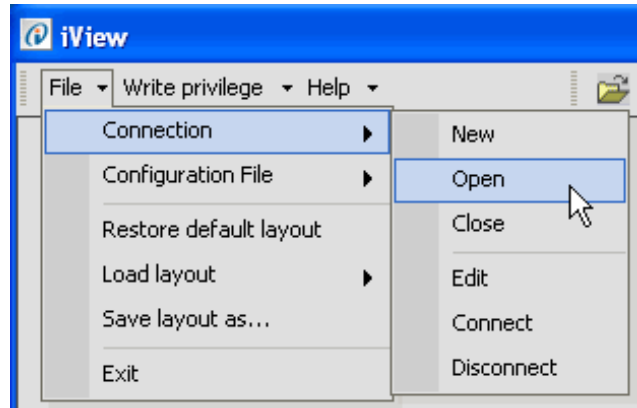


8. Enter a *File name* for this connection in the Save As dialog (the Connection automatically suggested).
9. The suggested (default) location for connections is the *Connections* folder (My Documents > Motion Control Engineering > iView > Connections). You may choose another location using standard windows methods. You may also create sub-folders inside the iController Connections folder in which groups of connections can be stored.
10. Click *Save* to save the connection.

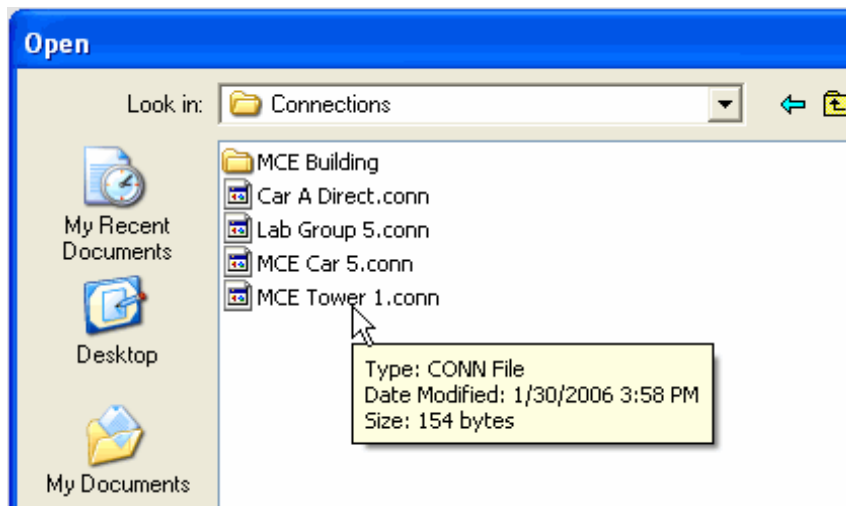


Connecting to the iBox Once the connection is created and saved, you are ready to connect.

1. Click the *Open Connection* button 
2. or click *File* on the menu bar, select *Connection* and click *Open*. The Open dialog appears.



3. To connect to a controller, double click the desired connection. The connection will take a moment or two to establish, then a main screen will appear.



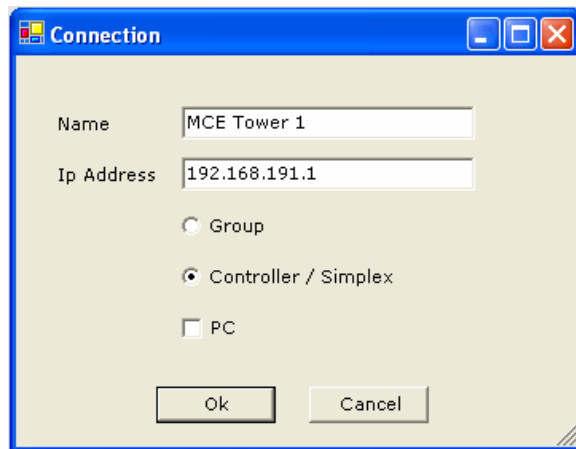
Note 

The default location for connection (.conn) files is the *Connections* folder (My Documents > Motion Control Engineering > iView > Connections). The default location for configuration (.cfg) files is the *Configuration* folder (My Documents > Motion Control Engineering > iView > Configuration). If you want to work online, connected to a controller, select *Connection > Open* from the File menu. Connection (.conn) files will be displayed in the Open dialog. If you want to work in an offline configuration file, select *Configuration File > Edit* from the File menu. Configuration (.cfg) files will be displayed in the Open Configuration File dialog. Refer to the [Working Online](#) and [Working Offline](#) topics later in this section for more information.

Editing an Existing LAN Connection

1. Click Edit on the File > Connection menu.
2. The Open dialog is displayed. Double click the connection you wish to edit. The connection dialog is displayed. Click in any field and correct the information you wish to edit.
3. Click **OK**.

You can edit existing LAN connections:

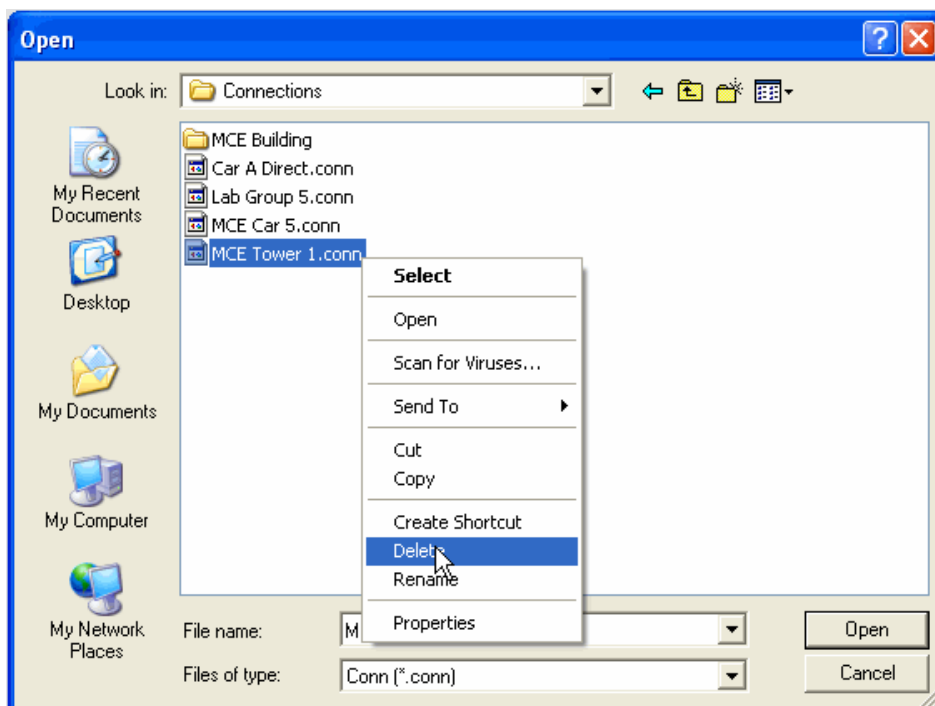


Delete an Existing LAN Connection

iControl Connections folder:

You can delete an existing connection from the

1. Select Edit on the File > Connection menu.
2. The Open dialog is displayed. Right-click on the connection you wish to delete.
3. Select *Delete* from the popup menu.



4. A warning dialog will appear. Click **Yes** to delete the connection or **No** to cancel without deleting.

Working Online

Working Online means that you are connected to an iController and are viewing or adjusting its parameters. To work online, select Open from File > Connection menu and double click the desired connection in the Open dialog.

When the connection is established, the Operational Status tab and Hoistway window are displayed with the Controller's *connection name* on the top left side of the title bar.

When iView is communicating with a controller, this symbol is displayed in the bottom left corner of the iView screen.



When iView is not communicating with a controller, this symbol is displayed in the bottom left corner of the iView screen.



The screenshot shows the iView software interface for MCE Car 5. The main window displays the 'Operational Status' tab, which is divided into several monitoring panels:

- Speed:** Commanded 0 fpm, Actual 0 fpm, Motor 0 rpm.
- Processor health:** Safety A, Safety B, and Cartop, all indicated as OK with green lights.
- In-service:** Safety OK, System comm, and In group, all indicated as OK with green lights.
- Faults:** An empty panel for displaying faults.
- Time remaining for:** Learn switch 15:00 min, Safety bypass 15:00 min, Fault bypass 15:00 min.
- Motion:** Cmd direction (black square), Actual direction (white square), and Category (AutoIdle).
- Position:** Logical 170.016 ft, Actual 170.016 ft, and Cartop 13563.39 ft.
- Machine:** Mode Stop, Arm voltage -0.18 Vrms, Arm current 0.01 Arms, Field voltage 38.28 Vrms, Field current 0.10, Brake voltage 0.47 Vdc, Brake current 0.03.
- Leveling sensor:** Front and Rear sections for Up leveling marker, Door zone, and Down leveling marker, all indicated as OK with green lights.
- Pattern:** Profile Idle and Phase Idle.
- Door Lock:** Front and Rear, both indicated as OK with green lights.
- Car status:** An empty panel for displaying car status.

On the right side, the 'Hoistway' window shows a 'Passenger' section with a speed and load gauge. The speed gauge is at 0 fpm and the load gauge is at 0%. Below the gauges is a vertical position scale with a 'Passenger' icon at the 150,000 ft mark. The scale ranges from 98,000 ft to 206,000 ft.

The status bar at the bottom of the window shows 'Local (Alternate Dispatcher)' and the date/time '12/15/2008 11:41:05 AM'.

When working online, you may:

- View and adjust any configurable settings.
- [Send adjusted settings to the controller.](#)
- [Save parameters to a Configuration file.](#)
- [Get parameters from a Configuration file and send them to the controller.](#)
- [Access Online Help](#)

Viewing and Adjusting Settings

To view and/or adjust settings, you first select the Configuration tab associated with those settings. There are two ways to select Configuration tabs:

1. Click the desired tab on the View > Configuration menu.
2. To display all of the configuration tabs (this takes a few seconds), click View > Layouts > Configuration. You can then click the desired tab (Configuration layout shown with Pattern/Modes tab selected).

The screenshot shows the 'Modes' configuration tab. At the top, there are several sub-tabs: Terminal Switches, Timer Tables, Serial I/O, Car Call Enable, Simplex Security, Simplex Configuration, IBox Configuration, Operational Status, Pattern, Brake, Car Operation, General, Drive, Safety, Load Weigher, I/O Board, and Motor Field. Below these, there are two main sections: 'Common' and 'Modes'. The 'Modes' section contains a table of profiles with the following data:

	Initial jerk	Acceleration	High roll jerk	High speed	Low roll jerk	Deceleration	Flare jerk	Approach deceleration	Approach jerk	Low speed
Standard	6.00	1.00	6.00	500.00	4.00	3.00	2.00	1.50	2.00	
Earthquake	6.00	2.00	6.00	150.00	4.00	2.00	2.00	1.00	2.00	
Emergency power	6.00	3.00	6.00	500.00	4.00	3.00	2.00	1.50	2.00	
Emergency slowdown	25.00	6.00	25.00	500.00	25.00	6.00	15.00	3.00	10.00	
Correction	6.00	1.00	6.00	50.00	6.00	1.00	2.00	0.50	3.00	
Inspection	6.00	1.00	6.00	50.00	6.00	1.00	2.00	0.50	2.00	25.00
Alternate 1	6.00	3.00	6.00	500.00	4.00	3.00	2.00	1.50	2.00	
Alternate 2	6.00	3.00	6.00	500.00	4.00	3.00	2.00	1.50	2.00	

At the bottom right of the 'Modes' section, there is a 'Send' button.

Some tabs have one or more “sub-tabs,” each supporting a related set of controls or displays. For example, if you want to adjust a timer associated with the brake, click the Brake tab and then click the Control tab. The Timer settings will appear.

To adjust a particular setting, Pick delay for example, you may either drag the cursor over the existing value and type in a new value or you may use the associated control (up/down arrows) to increase or decrease the setting.

The 'Timer' configuration sub-tab displays the following settings:

- Pick delay: 0.000 sec
- Hold delay: 2.000 sec
- Weakening delay: 0.000 sec
- Repick time: 0.000 sec
- Speed pick delay 1: 0.000 sec
- Speed pick delay 2: 0.000 sec
- Contactor drop delay: 1.100 sec
- Brake drop delay: 0.000 sec
- Voltage decay time: 0.000 sec
- Relevel drop delay: 0.000 sec

Sending Adjustments to the Controller

After making adjustments you will want to send the new parameter values to the controller. To send the new values:

1. Select *Acquire* from the Write privilege menu.
2. Press the “*Yes*” softkey on the iBox to grant the privilege request.
3. Then click *Send* to send changes to the controller. (The Send button becomes active when parameter changes have been made.)

Saving Parameters to a Configuration File

All of the iView settings associated with a controller can be saved in a configuration (.cfg) file. The .cfg extension identifies a file used to store information in a predetermined, fixed structure (XML).


Using configuration files to store settings on a hard drive, floppy diskette, CD-ROM, or other storage media provides some great capabilities:

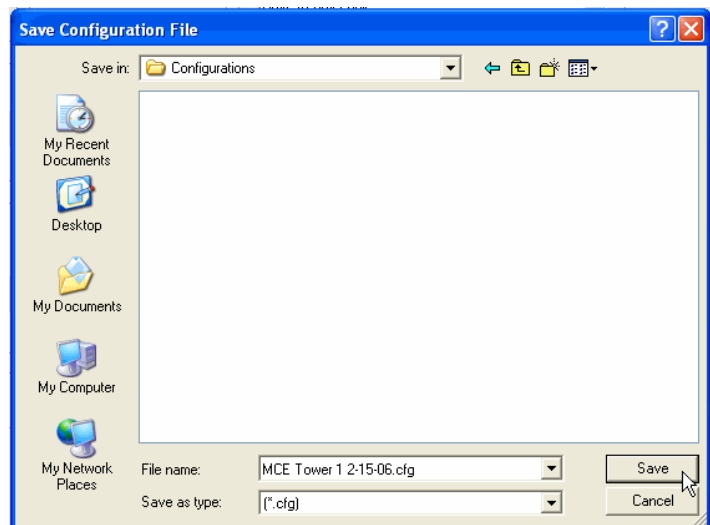
- **Working Offline:** Using iView, you can open a file and work with its settings without necessarily having access to the controller itself.
- **File Uploading:** When connected to a controller, you can choose to get some or all of the settings in a configuration file and send them to the controller.
- **Adjuster Portability/Flexibility:** Elevator adjusters can store configuration files associated with all the controllers they service on their laptop PC. They can edit values offline, then coordinate with on site, machine room personnel to connect and upload those changes to the controller through the elevator Local Area Network or, through modems, DSL, T1 or other internet connections, from virtually anyplace in the world.
- **Archiving controller data for future use.**

You create configuration files by saving controller parameters to a file while you are working online.

Save to File

While connected to a controller, you can easily save all controller parameters to a configuration (.cfg) file.

1. Click the *Save Configuration File* button 
2. or select *Save* from the *File > Configuration* menu. A typical Windows save dialog appears.
 - The default name suggested for the file will be the controller connection name with .cfg appended. **Caution:** If the parameters for this controller have previously been saved using the default name, those previously saved parameters will be overwritten unless you change the file name. You may want to add a number or date to the file name.
 - The default folder suggested in the dialog is the Configurations folder (My Documents > Motion Control Engineering > iView > Configurations).
3. Click *Save* to save the file.
4. Once you have saved the file, it will appear in the Open Configuration File dialog the next time you select either Load or Edit from the File > Configuration menu.

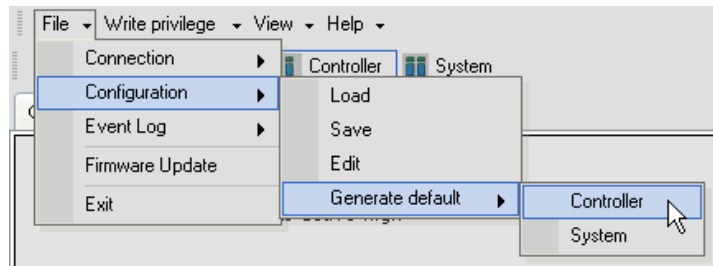


Saving Default Parameters to a Configuration File

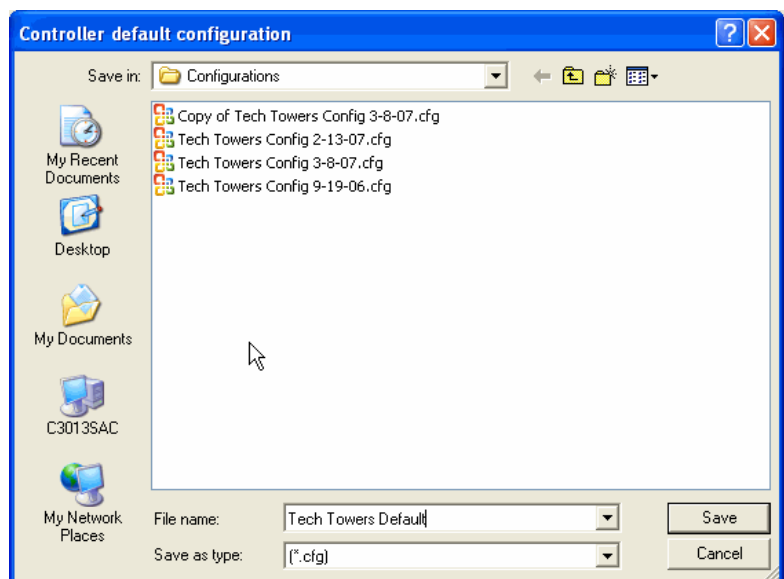
The Controller and/or System default parameter settings can be saved to a configuration (.cfg) file. The default parameter values can then be loaded onto the controller should you determine that you want to start making adjustments beginning with the default values.

To Save the Default Parameters:

1. Select *Controller* or *System* from the *File > Configuration > Generate default* menu. The Controller or System default configuration dialog appears.



2. In the *Controller or System default configuration* dialog, enter the desired file name.
3. The default folder suggested is the *Configurations* folder (My Documents > Motion Control Engineering > iView > Configurations). You may change this if you so desire.
4. Click *Save* to save the file.
5. Once you have saved the file, it will appear in the Open Configuration File dialog the next time you

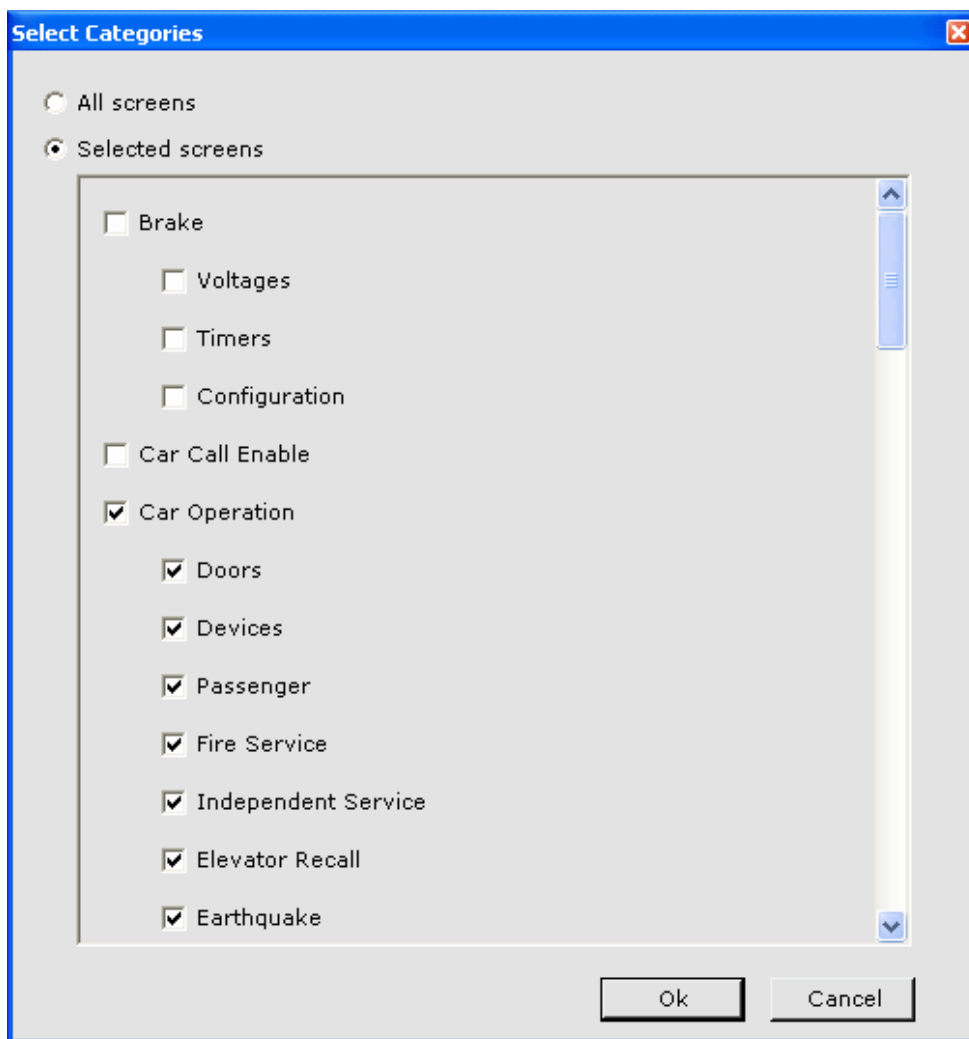
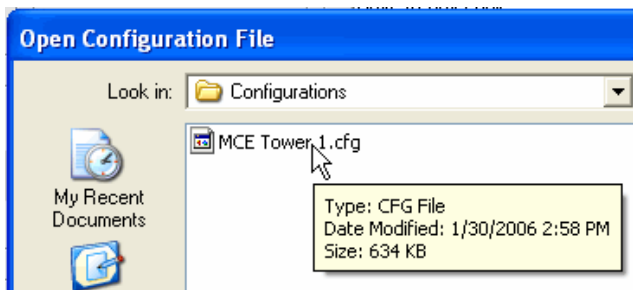


select either Load or Edit from the *File > Configuration* menu. You can load the default parameters onto the controller by selecting *Load* from the *File > Configuration* menu as described on the next page.

Loading Parameters from a Configuration File


When working online (connected to a controller), you may load (send) selected data from a previously saved configuration (.cfg) file to the controller (after ensuring that it is safe to do so and setting the iBox Controller Stop switch appropriately).

1. Acquire Write Privilege (select Acquire from the Write Privilege menu).
2. Select *Load* from the File > Configuration menu.
3. The Open Configuration File dialog is displayed, allowing you to choose the desired configuration file. Select the file and click *Open* or double click the file.
4. The Select Categories dialog opens allowing you to choose the data to send: “All screens” or data from “Selected screens”.
5. After selecting the desired data, click *Ok* to send or *Cancel*. If you selected “All categories” or any “Security” parameters, you must enter the Security Password and click *Ok*. The default security password is “manager”.



Working Offline

Working offline means that you are not connected to a controller but are working with a configuration (.cfg) file. You must have previously created the configuration file by saving it while working *on line* with a controller. Please refer to “Saving Parameters to a Configuration File” on page 8-20. To work offline:

1. Launch iView.
2. Select *Edit* from the File > Configuration menu.
3. The Open Configuration File dialog opens. Double-click or select the desired configuration file and click Open. The .cfg extension indicates that this is a configuration file used when working off-line.
4. A top level screen resembling the controller screen will appear. The title bar of the screen displays the path and file name. You access the parameter screens and edit parameters just as you do online. However, you cannot send parameters to a controller while offline. Please refer to “Loading Parameters from a Configuration File” on page 8-22.
5. To save changes, click the Save button .

Note

While working offline you will not be able to view some real-time data screens such as Hoistway and Floor Heights.

To copy a configuration file: You may not want to modify the original configuration file. Instead, you can make a copy of the original and then edit the copy.

1. Click the *Start* button.
2. Click *My Documents*.
3. Double click the *Motion Control Engineering* folder.
4. Double click the *iView* folder.
5. Double click the *Configurations* folder.
6. Select the configuration file and click “Copy this file” in the File and Folder Tasks list.
7. Select a location from the *Copy Items* dialog and click *Copy*.
8. Right click the copied file and select *Rename*.
9. Type the new name and press *Enter*.
10. From the File menu in iView, select *Configuration > Edit*.
11. Select the file from the *Open Configuration File* dialog and click *Open*.
12. Edit and Save the file.

Accessing Online Help

iView offers extensive online help. Help is available whether you are working online or offline. On-line help is incorporated into iView to provide information about iControl screens and parameters. You can access iView On-line Help in the following ways:

Context Sensitive Help You can view On-line Help information about any screen or tab by pressing function-key one (F1) while a screen or tab has focus. Do the following:

- Click the title bar of a window, e.g., the Hoistway window, to bring focus to the window. The background color of the window's title bar darkens indicating that the window has focus. Then press the F1 key. iView Help will display the topic that describes the window.
- Click a tab (title). An outline will appear around the tab title indicating that the tab has focus. Then press the F1 key. iView Help will display the topic that describes the tab.

Context Sensitive Event Help The Controller logs status and error information in the Event Log (see [“Diagnostics - Diagnostic Outputs” on page 9-13](#)). To view the Event Log, Event Properties and Context Sensitive Event Help:

1. In the Controller view, click View > Diagnostics > Event Log to display the Event Log.
2. Double click an event in the Event Log to display the Event Properties dialog.
3. Click the Help button in the Event Properties dialog to display the Troubleshooting Tips dialog which provides a description of the event, an indication of what action is taken, and troubleshooting tips if appropriate.

Help Viewer iView On-line Help provides three additional ways of locating information. The Contents and Index tabs let you find general information. The Search tab lets you look up specific words or phrases.

To start iView On-line Help:

1. On the iView menu bar, click Help.
2. On the Help menu, click iView Help. The help viewer is displayed. Use the Contents, Index or Search tabs to locate the desired information.

iView On-line Help provides the following kinds of information:

- Using iView Help - A description of the many options, capabilities and ways of using iView On-line Help.
- Using iView - Provides information and instructions on how to use the iView graphical user interface.
- iView Windows and Tabs - Lists all of the iView windows and tabs and provides links to descriptions of the parameters on each tab.
- Message Reference - An alphabetical listing of iControl status and error messages. Each listing includes a description, an indication of what action is taken, and troubleshooting tips.
- Parameter Reference - a tab by tab listing of all of the Controller and System parameters including a description of each parameter.

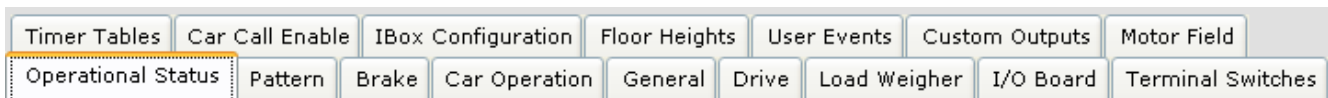
iView Windows and Tabs

The *View* menu is used to navigate to the various windows and tabs in the Controller view and System view. Many tabs have subordinate tabs that are not shown here, but are documented in the Content Overview tables that follow.

Controller - Configuration Tabs

Controller parameter settings are displayed and may be changed on the Controller - Configuration tabs. The Configuration tabs may be accessed in one of two ways.

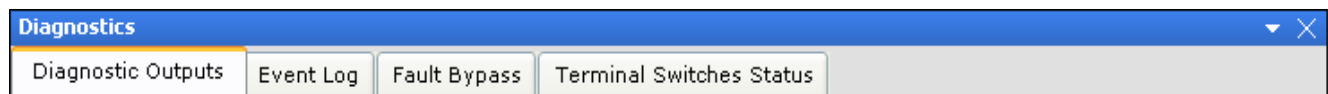
1. While in Controller view (see “[Selecting Controller View](#)” on page 9-1), select the desired tab from the View > Configuration menu.
2. Display all of the Configuration tabs by selecting *Configuration* from the View > Layouts menu. Then click the desired configuration tab.



Controller - Diagnostic Tabs

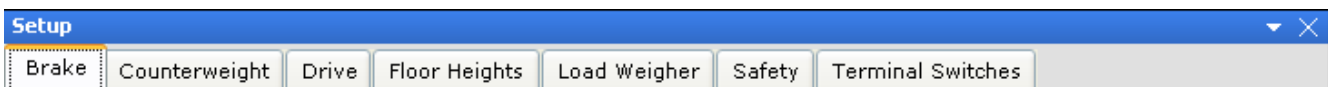
The Controller - Diagnostic tabs contain information about the status and condition of the controller. The Diagnostic tabs can be accessed in one of two ways.

1. Select the desired tab from the View > Diagnostics menu.
2. Display all of the Diagnostic tabs by selecting *Diagnostics* from the View > Layouts menu. Then click the desired diagnostics tab.



Controller - Setup Tabs

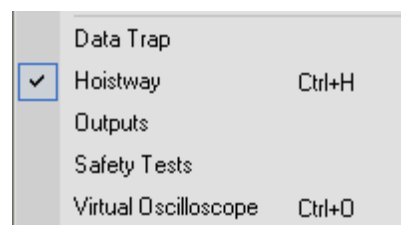
The Controller - Setup tabs are used to perform the iControl automatic and semi-automatic setup procedures. The Setup tabs can be accessed by selecting *Setup* from the View menu. Then click the desired calibration tab.



Additional Windows

Additional windows can be accessed from the View menu. They include:

- Data Trap
- Hoistway
- Outputs
- Safety Tests
- Virtual Oscilloscope



Specific contents will vary depending on the hardware installed at your site and on the revision level of your iView and iBox software. Always refer first to the online help available within iView. Online help contains the most detailed and current information about your iView software. For detailed parameter or display descriptions, refer also to [Section 9](#) of this manual.

Table 5.2 lists the items on the *View* menu and tables 5.3 through 5.5 list the tabs found on the Configuration, Diagnostics and Setup menus. Click the “see page” links to jump to that page.

Table 8.2 Controller - View Menu

Window	Content
Configuration	Parameter settings are displayed and may be changed on the Configuration tabs. The tabs include Brake, Car Operation, Drive, General, I/O Board, Load Weigher, Motor Field, Pattern, Safety, Serial I/O Simplex Configuration, Simplex Security, Terminal Switches and Timer Tables (see page 9-24).
Diagnostics	The Diagnostic tabs contain information about the status and condition of the controller. The tabs include Diagnostic Outputs, Event Log, Fault Bypass, Operational Status and Terminal Switches Status. Three additional diagnostic screens, Data Trap, Diagnostic Outputs and Virtual Oscilloscope, are displayed each in their own window. This allows them to be used with other windows (see page 9-11).
Setup	The Setup tabs are used to perform the automatic and semi-automatic setup procedures. The tabs include Brake, Counterweight, Drive, Floor Heights, Floor Offsets, Load Weigher, Safety and Terminal Switches (see page 9-140).
Hoistway	A graphical representation of the car in the hoistway, including assigned car and hall calls. Shows the current mode of operation, direction preference, speed and actual floor height information (see page 9-4).
Safety Tests	Automated control of acceptance test procedures (see page 9-152).
Layouts	Pre-programmed screen layouts can be displayed. Custom screen layouts can be created and saved and displayed (see page 9-153).

Table 8.3 Controller - Configuration Tabs

Tab	Sub-Tab	Content
Advanced	Custom Outputs	Allows existing inputs, outputs and internal flags to be combined in a logic equation which can then generate a custom output (see page 9-139).
	User Events	Configure User Events (see page 9-138)
Brake	Control	Brake voltage, timer and filter settings (see page 9-25).
	Configuration	Brake voltage, Output timer, and Current reference settings for braking progression at 10% increments (brake fine tuning) (see page 9-27).
Car Call Enable		Configure the enable inputs to be active high or low (see page 9-28).
Car Operation (see page 9-29)	Doors	Door motor protection timer settings, safe edge and photo eye bypass selections, plus front and rear door closing delay, etc. (see page 9-30).
	Devices	Hall and car gong settings, emergency alarm monitoring and serial fixture parameters (see page 9-33).
	Passenger	Anti-nuisance, nudging, exercise operation, automatic swing operation, and door operation settings for car in normal passenger service (see page 9-37).

Table 8.3 Controller - Configuration Tabs

Tab	Sub-Tab	Content
Car Operation (continued)	Fire Service	Main and alternate recall, fire code selection, and door functionality for car in fire service operation (see page 9-44).
	Independent Service	Door and call functionality for car on Independent service (see page 9-59).
	Elevator Recall	Recall floor, call disposition, door operation, and override settings for car on recall operation (see page 9-61).
	Earthquake	Counterweight displacement sensor enable/disable, and earthquake code selection for car on earthquake operation (see page 9-64).
	EMS	Emergency Medical Service settings (recall floor, switch, and doors etc.) (see page 9-66).
	Emergency Power	Includes recall, generator and door settings for car on Emergency Power operation (see page 9-70).
	CFSS	Commandeer for Special Services. Parameters determine car behavior when operating in CFSS Recall and In-car modes (see page 9-73).
	Flood operation	Determines Flood operation floors, substitute Emergency Power and Fire recall floors, and Flood operation bypass settings (see page 9-76).
	Attendant service	Set front and rear door operation parameters used during Attendant Service operation (see page 9-78).
	Auto stop	Parameters determine car behavior during Automatic Stop operation (see page 9-79).
	Sabbath operation	Enable/disable, select floors and other parameters that determine car behavior while on Sabbath operation (see page 9-81).
	Shuttle Service	Allows a car to provide express service for a subset of the building's floors (see page 9-84).
Drive	General	Drive type selection, speed reference selection, speed reference configuration, and system drive-related selections for drive (see page 9-88).
	Safety	Speed reference and over-current settings (see page 9-90).
	Filters	Drive notch and system filter settings (see page 9-91).
	Pre-Torque	Pretorque enable/disable and option settings (see page 9-92).
	Calibration	Drive offset settings (see page 9-93).
Floor Heights	Configurations	Use to view the learned values for the floor heights (see page 9-94).
	Floor Offsets	Use to view the learned values of the floor offsets (see page 9-94).
General	General	Job information, car label, ID, simplex car and backup dispatcher options (see page 9-95).
	Floors Data	Front and rear opening settings for all floors (see page 9-96).
	Car Call Eligibility	Car Call eligibility settings for all floors. Default eligibility configurations to be used during special modes of operation, e.g. Independent service (see page 9-97).
I/O Board	Configuration	Graphical display and organization of controller and cartop I/O boards including specific input and output assignment on connectors (see page 9-100).
	Configurable outputs	Determines during which modes of operation the Door Enable Output, Automatic Closing Output and/or Hall Door Button Output are disabled.
IBox Configuration		IP information for iControl (see page 9-125).
Load Weigher		Load Weigher configuration and threshold settings (see page 9-126).

Table 8.3 Controller - Configuration Tabs

Tab	Sub-Tab	Content
Pattern	Common	Display and edit parameters common to all pattern profiles. Position encoder resolution, leveling and releveling speeds, pattern scaling, dead zone distance, door pre-opening distance, and position synchronization by floor or terminal switches (see page 9-128).
	Modes	Parameter settings for Standard, Earthquake, Emergency power, Emergency slowdown, Correction, Inspection, and Alternate 1-2 profiles.
Terminal Switches		Position margin settings for up and down normal terminal and emergency terminal switches, and Overspeed 1 margin setting (see page 9-134).
Timer Tables		Programming of timed operations (Sabbath, Swing and Auto stop operation). (see page 9-135).

Table 8.4 Controller - Diagnostics Tabs

Tab	Sub-Tab	Content
Operational Status		Displays the car status including: motion, speed, position, pattern, motor and brake, processor, in-service, leveling, door locks, faults and car status (see page 9-8).
Data Trap		Use this tool to record and analyze controller data including input and output states, internal flags and parameter values (see page 9-11).
Diagnostic Flags	Car Operation	Displays status of car operation input and output flags, including front and rear doors, e.g. car call above, car call below. Click arrow buttons to display dependent outputs (see page 9-12).
	Motion	Displays the status of Passenger (automatic) and Inspection mode motion related inputs and outputs, e.g. Ready, Synchronization and Qualifier status.
	Drive	Displays the status of Drive related inputs and outputs, e.g. Up direction request, Pattern enable, and Motor run mode.
	Safety	Displays the status of Safety related inputs and outputs, e.g. Car top exit open, Governor open, and Safety (Car) open.
Diagnostic Outputs		Selection and display of up to sixteen system outputs for monitoring or diagnosis. Hundreds of outputs are available (see page 9-13).
Event Log		Display of recorded controller events (see page 9-14).
Fault Bypass		Enable/disable selected system faults to facilitate adjustment and testing. Display of faults currently bypassed (see page 9-17).
Terminal Switches Status		Displays the learned terminal switch speeds and positions, overspeed and position fault thresholds and last pass positions and speeds (see page 9-19).
Virtual Oscilloscope		An on-board oscilloscope with software selection of test point signals to be monitored and customizable display (see page 9-21).

Table 8.5 Controller - Setup Tabs

Tab	Content
Brake	Calibrate the brake voltage settings (see page 2-48 and page 9-140).
Counterweight	Learn the position where counterweight is adjacent to the car (see page 3-28 and page 9-141).
Drive	Learn the values for the Drive Offsets (see page 2-48 and page 9-142).
Floor Heights	Learn the absolute floor positions (distance to each floor from the lowest landing). Also used to assist in measuring and entering the floor offsets (deviation of floor magnet position from actual floor stopping position) (see page 4-2, page 4-26, page 9-143 and page 9-145).
Load Weigher	Learn the car empty and full load weights (see page 4-32 and page 9-146).
Safety	Verify that the configurations of the main and safety processors match. Perform the Inventory learn procedure (see page 9-147 and page 9-150).
Terminal Switches	Learn the speeds and positions of the normal and emergency terminal switches (see page 4-9 and page 9-151).

Table 8.6 Controller - Miscellaneous Dialogs/Controls

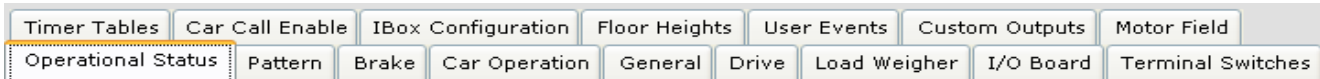
Tab	Content
Call Registration	Allows you to register car and hall calls. This control is accessed by clicking the Call Registration button on the button bar (see page 9-154).
Firmware Update	Guides you through the process of updating iControl firmware. This control is accessed by selecting Firmware Update from the File menu (see page 9-155).
Refresh	Updates the information displayed on iView windows and tabs. This control is accessed by clicking the Refresh button on the button bar.

Controller - Layouts

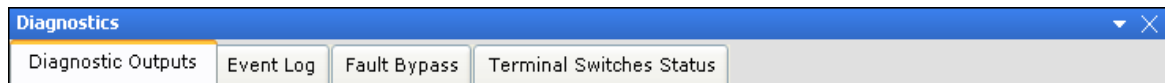
With iView, you can move and size tabs to suit the task to be performed. When you find a particular arrangement to be useful, you can save it as a custom layout (View > Layouts > Save as). You can then display that layout at any time by selecting your custom layout from the View > Layouts > Custom menu.

Some useful layouts have been pre-programmed and are supplied with iView. They include:

- **Configuration:** This layout displays all of the configuration tabs for easy selection.



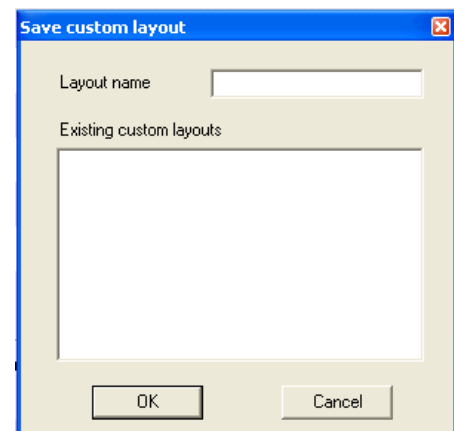
- **Diagnostics:** Displays all of the diagnostic tabs for easy selection.



- **Default:** Displays the default (initial connection) layout.

-
- **Brake:** Used to perform the brake calibration procedure. Displays the Brake setup and configuration tabs plus the Hoistway pane.
 - **Drive:** Used to perform the drive offsets calibration. Displays the Drive setup and configuration tabs plus the Hoistway pane ([see page 2-48](#)).
 - **Floor Heights:** Used to perform the hoistway (floor heights) learn operation. Displays the Floor Heights setup and configuration tabs plus the Hoistway pane.
 - **Load Weigher:** Used to perform the Load Weigher learn procedure. Displays the Load Weigher setup and configuration tabs plus the Hoistway pane.
 - **Motor Field:** Used to perform the Motor Field calibration procedure. Displays the Motor Field setup and configuration tabs plus the Hoistway pane.
 - **Terminal Switches:** Used to perform the Terminal learn procedure. Displays the Terminal Switches setup, configuration and diagnostics tabs plus the Hoistway pane.

-
- **Custom:** Used to select a custom layout to be displayed. This is the listing of custom layouts created using View > Layouts > Save as.
 - **Save As:** Used to create and save a custom layout.
 - Enter the name for the custom layout.
 - Click OK.



System View Windows and Tabs

System - Configuration Tabs

System parameter settings are displayed and may be changed on the System - Configuration tabs. The Configuration tabs may be accessed in one of two ways.

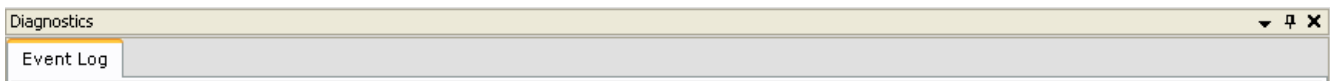
1. While in System view (see “[Selecting System View](#)” on page 10-1), select the desired tab from the View > Configuration menu.
2. Display all of the Configuration tabs by selecting *Configuration* from the View > Layouts menu. Then click the desired configuration tab.



System - Diagnostic Tabs

The System - Diagnostic tabs contain information about the status and condition of the system. The Diagnostic tabs can be accessed in one of two ways.

1. Select the desired tab from the View > Diagnostics menu.
2. Display all of the Diagnostic tabs by selecting *Diagnostics* from the View > Layouts menu. Then click the desired diagnostics tab.



Additional Windows

Additional windows can be accessed from the View menu. They include:

- Hoistway
- System Performance
- Layouts

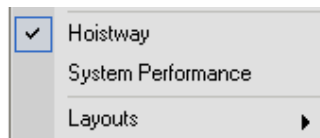


Table 8.7 System - View Menu

Window	Content
Configuration	System parameter settings are displayed and may be changed on the Configuration tabs. The tabs include Emergency Power, System Configuration, Legacy Group Interface, Security, System I/O, Timer Tables, User Inputs and User Outputs (see page 10-2).
Diagnostics	The System Diagnostic tabs contain information about the status and condition of the system. The tabs include Event Log (see page 10-68).
Hoistway	A graphical representation of the cars in the system hoistways, including assigned car and hall calls. Shows the current mode of operation, direction preference and current floor for each elevator (page 10-70).
System Performance	Graphical representation of system performance statistics (see page 10-74).
Layouts	Use to load Configuration, Diagnostic or Custom layouts (see page 10-75).

Table 8.8 System - Configuration Tabs

Tab	Sub-Tab	Content
Emergency Power		Use to indicate cars connected to each generator and define how switching to and from emergency power is handled (see page 10-33).
System Configuration	Building	Floor definition and labeling. Car definition and labeling (see page 10-7).
	CFSS	Definition of Commander For Special Services modes 1 and 2 (see page 10-9).
	Dispatching	Define system dispatching options and manually select dispatching configurations (see page 10-11)
	Hall Call Eligibility	Define up to eight Hall call eligibility configurations (see page 10-13).
	Mode of Operation	Define up to eight dispatching Mode of Operation configurations (see page 10-14).
	Parking	Define up to eight Parking configurations (see page 10-21).
	Parking Eligibility	Define up to eight Parking Eligibility configurations (see page 10-27).
	Split Bank	This capability is only available through the Central Dispatcher (see page 10-29).
Legacy Group Interface		Select either Cross-cancellation or Cross-registration (see page 10-36).
Security	General	Shows the status of System Security. Use these controls to configure car and hall call restrictions for a simplex or swing car or car assigned to be the backup or local dispatcher for a group (see page 10-38).
	Hall Calls	
	Car Calls	
System I/O	System	Configuration of system input/output settings (see page 10-51).
	Bus	Serial bus troubleshooting.
Timer Tables		Use to configure timer tables to control system functions, e.g., Hall call eligibility, Parking, Parking eligibility, Mode of operation, Security, and User outputs 1 through 3 (see page 10-62).
User Events		Define User Events which, when assigned a hardware input, are logged on the System Event Log when activated and deactivated(see page 10-65).
Remote Outputs	Configuration	Define and configure up to 32 Remote Outputs which can be wired to any input or other device as needed (see page 10-66).
	Trigger	

Table 8.9 System - Diagnostic Tabs

Tab	Content
Event Log	Display of recorded system events (page 10-68).

Table 8.10 System - Miscellaneous Dialogs/Controls

Tab	Content
Call Registration	Allows you to register car and hall calls. This control is accessed by clicking the Call Registration button on the button bar (see page 10-73).
Refresh	Updates the information displayed on iView windows and tabs. This control is accessed by clicking the Refresh button on the button bar.

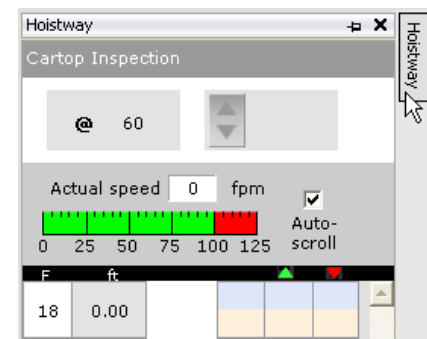
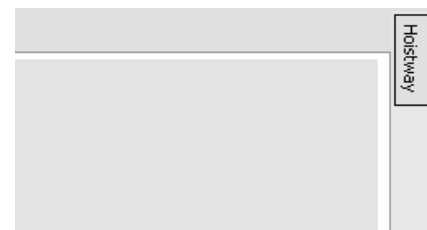
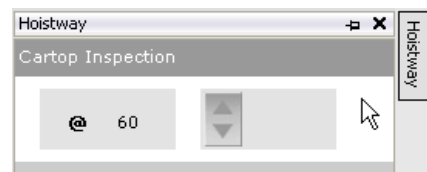
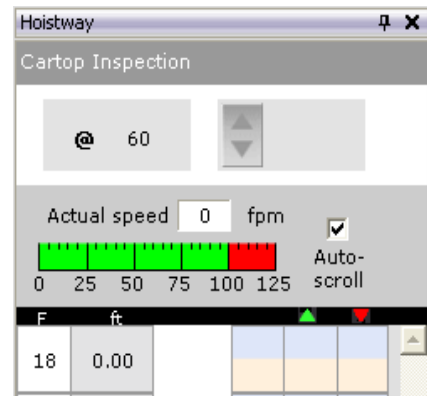
Pinning and Unpinning Windows

Notice that iView windows have a little push-pin icon in the upper right corner, e.g. the Hoistway window shown on the right.

- When the pin is pointing down, the window is “pinned” in its designated position.
- If you click the pin icon, it points to the left and a button, labeled Hoistway, appears to the right of the window.
- The window remains in view if the window has focus (click the window title bar) or as long as the mouse cursor remains on the window or button.
- But if another window has focus and you move the mouse cursor off of the window or button, the window collapses out of view.
- To temporarily bring the window into view again, place the mouse cursor over the button. The window slides into view and will remain in view if you click the window’s title bar or as long as the cursor remains on the button or window.

To permanently display the window again:

1. Bring the window into view by placing the cursor over the button.
2. Click the pin so that it is pointing down again.

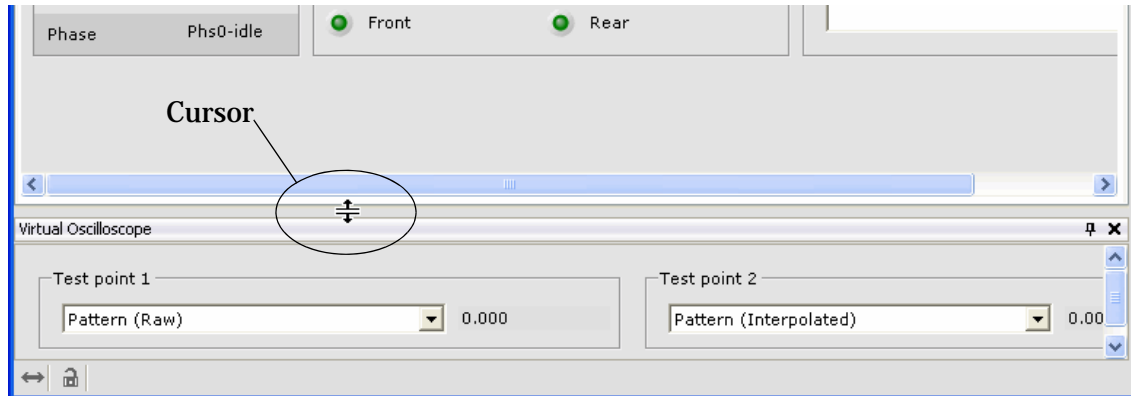



Resizing Windows

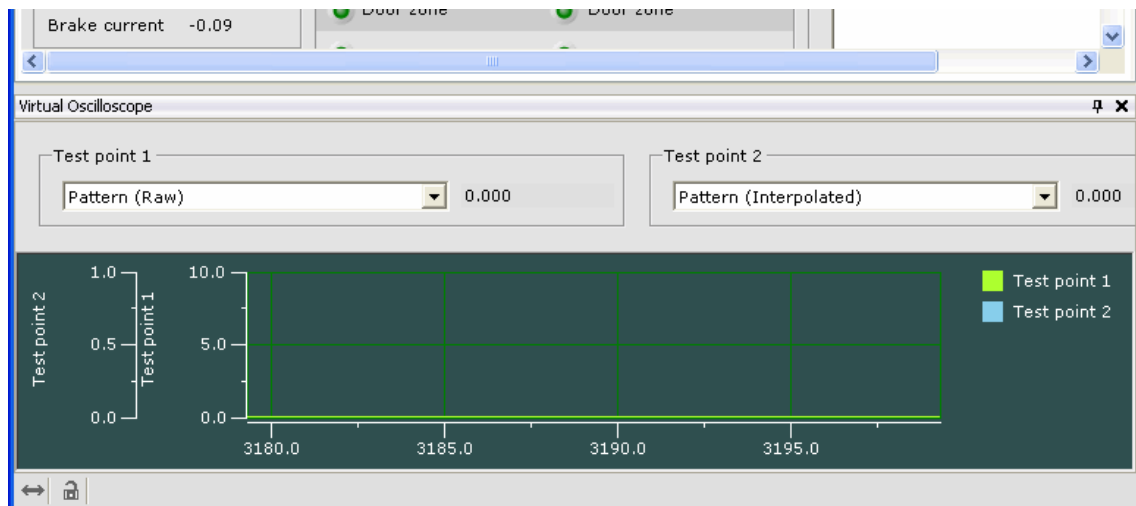
iView windows can be resized so that you see just the data you need to perform a test or task.

To resize a window:

1. Place the mouse cursor in the space between the windows.



2. When the cursor changes to a double line with arrows,  you can click and drag (hold the left mouse button down while moving the mouse) the window boundary and resize the window.

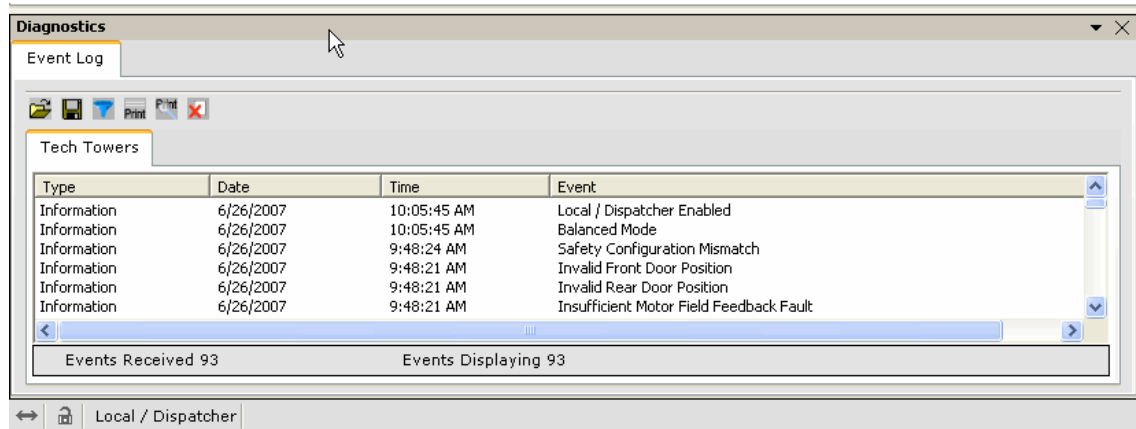


Docking and Undocking Windows

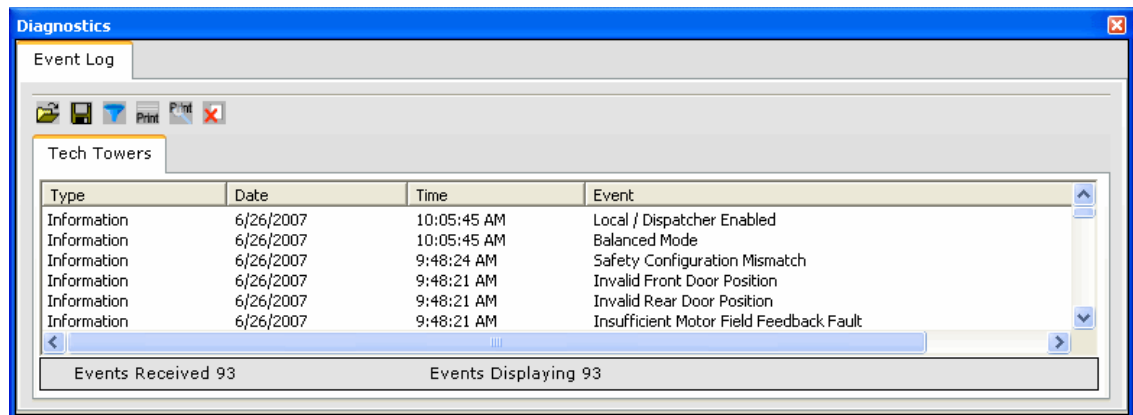
iView windows can be undocked from their assigned position and moved to another position on the screen.

To undock and move a window:

1. Notice that the Diagnostics window is positioned at the bottom of the screen (connection arrows at bottom left corner). Double click the window title bar.



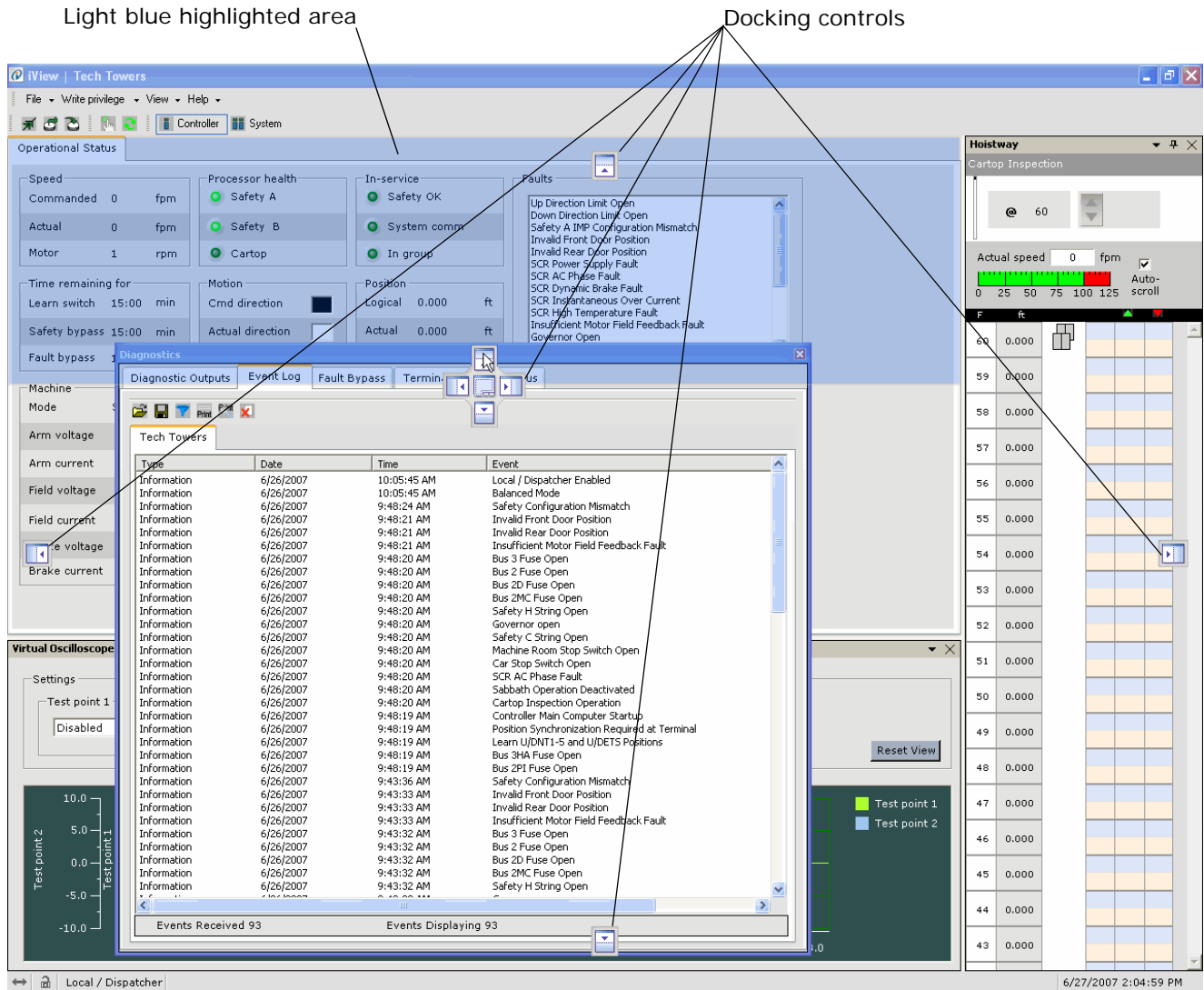
2. The title bar and frame around the Diagnostics window change to a solid blue line indicating that the window is now undocked and can be moved.



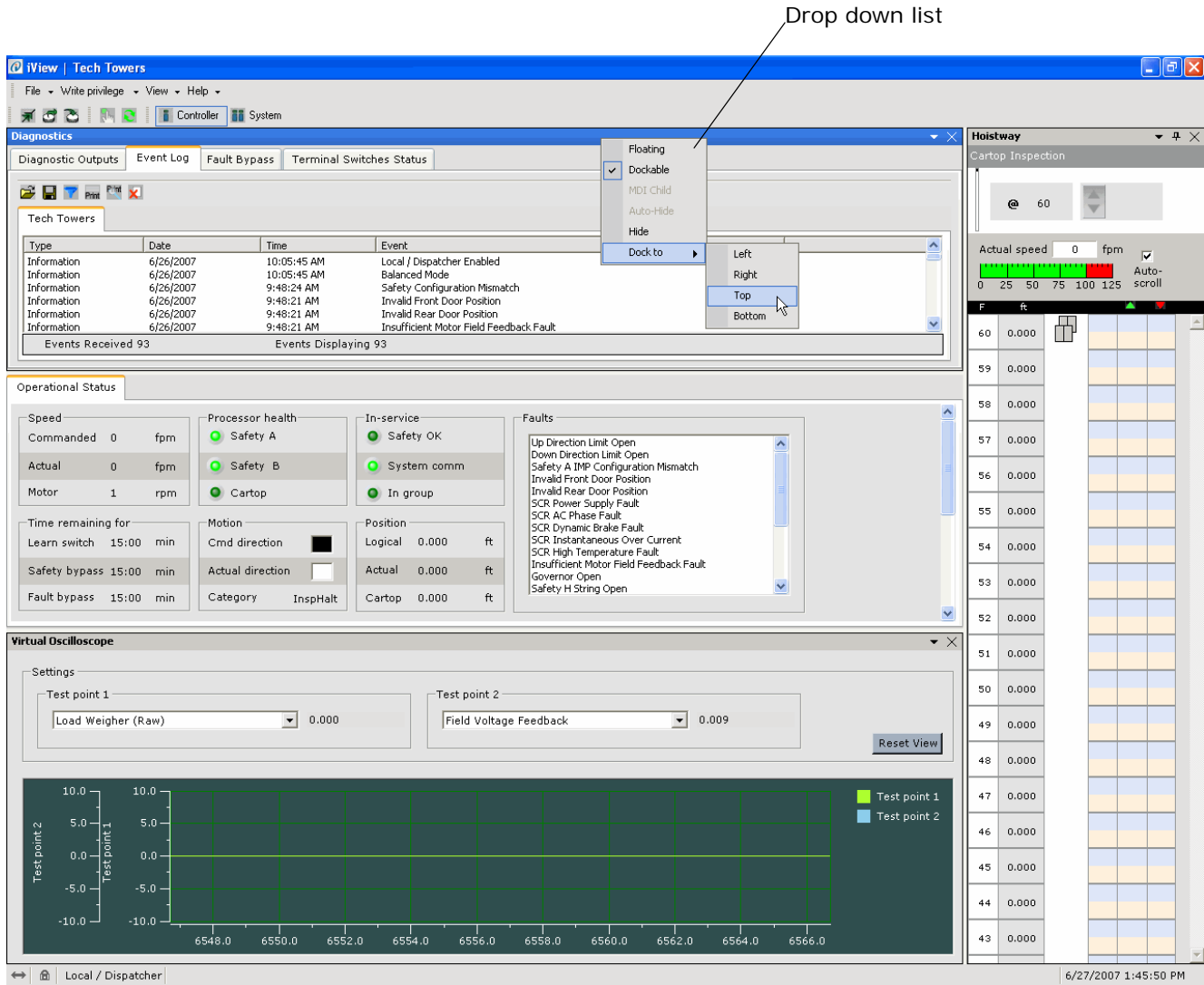
3. Click the title bar and drag (hold down the left mouse button while moving the mouse) the window to a new location.
4. Release the mouse button. The undocked window will appear in the new location, on top of what ever is in that location. You can tell that it is undocked because the solid blue frame remains.
5. You can quickly return the window to its original docked location by double-clicking in the window's title bar.

To dock a window in a new location:

1. Notice that while moving an undocked window, docking controls appear near the center and at the top, bottom and sides of the screen. As you slide the cursor over the controls, a light blue highlight indicates the position to which the window will be moved. Release the mouse button and the window docks in the new location.



- An alternate method of moving a window is to right click the title bar of the window. In the drop down list that appears, select *Dock to* and click the desired location. In the example below, the Diagnostics window has been moved to the top of the screen.



- If you like this arrangement and would like to be able to easily display this arrangement in the future, you can save it as a Custom Layout. Please refer to “Controller - Layouts” on page 8-30.

Printing Screens

1. With the screen displayed, press the Print Screen key to send the entire screen to the clipboard (PC memory).
2. To send only the selected item (window or dialog) to the clipboard, press and hold the Alt key, then press the Print Screen key.

Items sent to the clipboard can be pasted into any of several applications. One that you should definitely have on your PC is Wordpad.

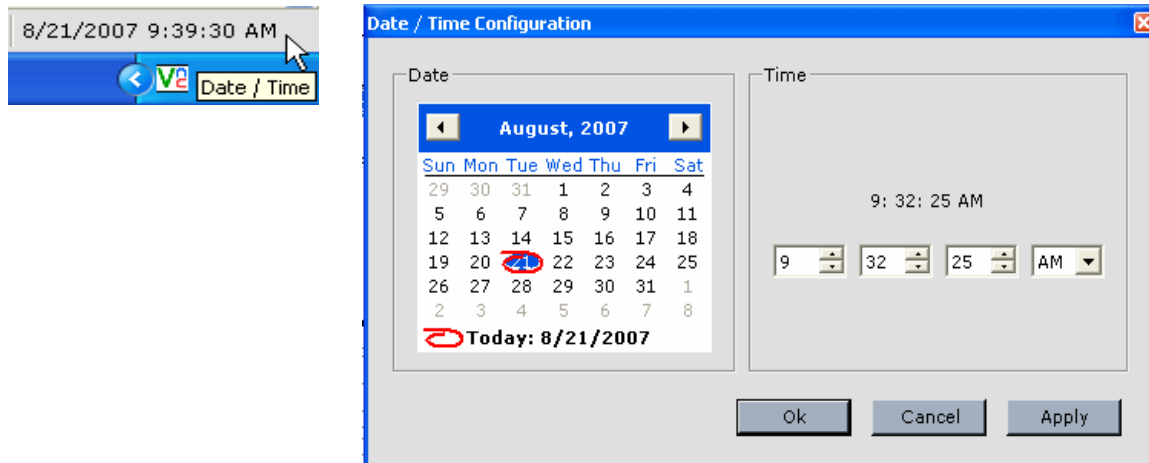
3. Open the Wordpad application (Start > All Programs > Accessories > Wordpad).
4. Select *Paste* from the *Edit* menu or press and hold the Ctrl key while pressing and releasing the “v” key to paste the captured screen into Wordpad.
5. Select *Print* from the *File* menu to print the screen.
6. Save the file if you want to keep a record of the screen on the PC hard drive.

Setting the System’s Date and Time

The iControl system’s time and date can be set using the iView application connected to the Central Dispatcher (iCue PC), Local/Dispatcher or Simplex car controller. The dispatcher’s time and date are transferred to all local cars that are running (communicating) and all other cars as they power up.

To set the time and date:

1. Establish an iView connection to the system dispatcher or simplex car.
2. Double-click the time/date display at the bottom-right of the *status bar* (shown below). The **Date / Time Configuration** dialog will appear:



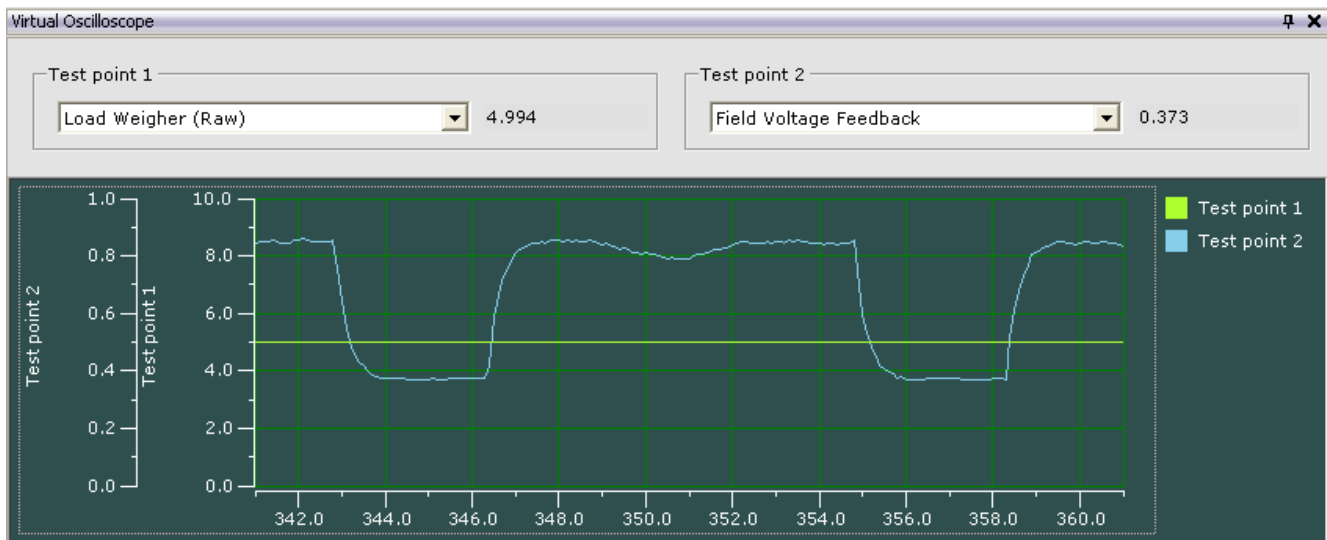
3. Use the controls to set the date and/or time and click Apply or OK. The date and time will be updated on all controllers communicating with the dispatcher.

Note

The iView PC’s time, which is displayed at the very bottom-right corner of the screen, is not the same as the iControl system’s date and time. The iControl system’s date and time are displayed on the *iView status bar* and are set using the *Date / Time Configuration* dialog shown above.

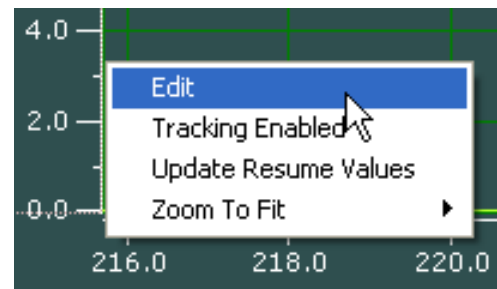
Editing Dynamic Displays

The virtual oscilloscope display is editable. You may easily modify labels, displays, animation, and more to suit your immediate display needs. When a display is closed, then re-opened, it reverts to its default values.

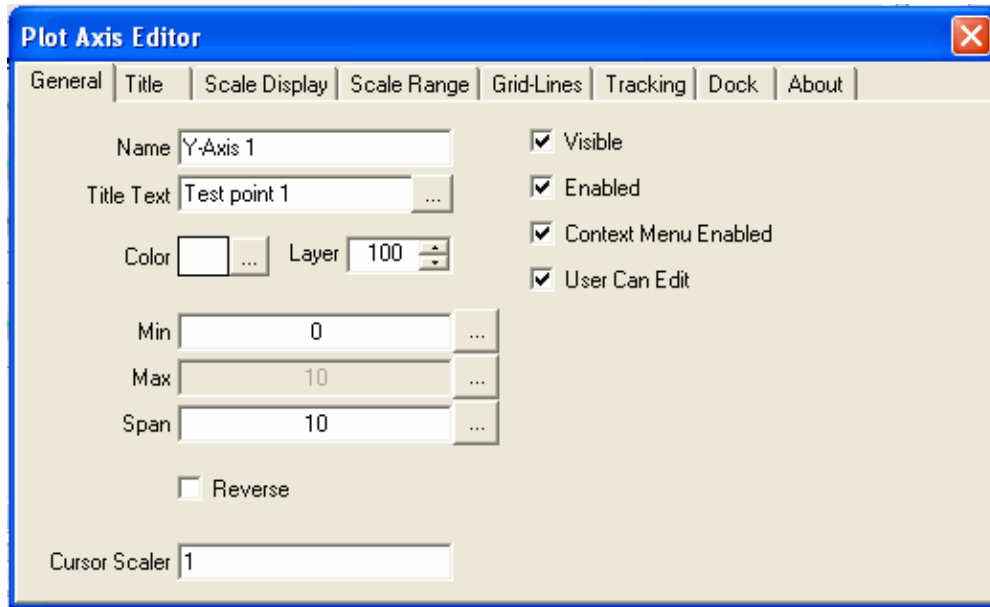


To edit a display:

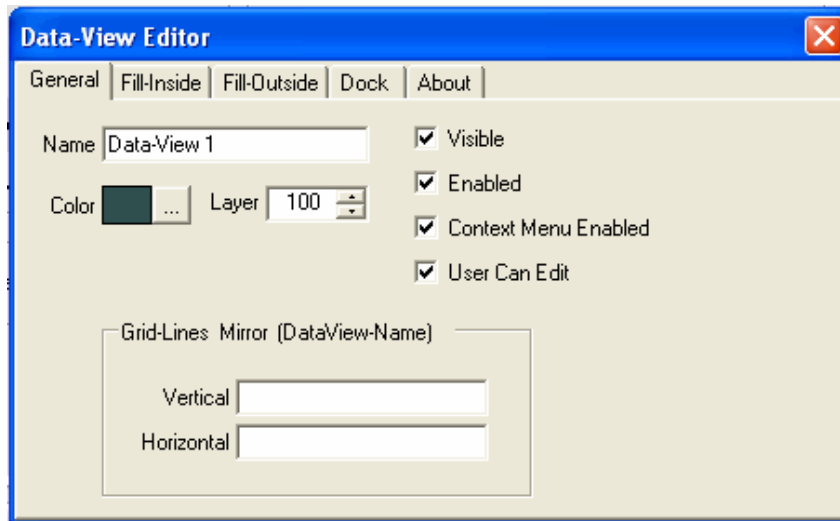
1. Right-click on the graph or on one of the scales to reveal a popup menu. Select *Edit* from the menu.



2. Experiment with modifying the display to find the combinations that suit the signal types you are currently examining. The Edit menu is extensive:



3. Several different editors are available depending on where you click in the graphic display.



Quick Topics

- About this Section
- Selecting Controller View
- iVIEW Windows and tabs
- Hoistway
- Operational Status tab
- Diagnostic tabs
- Configuration tabs
- Setup tabs
- Data Trap
- Outputs
- Safety tests
- Virtual Oscilloscope
- Layouts
- Call registration
- Firmware update



iView - Controller View



About this Section

This section contains detailed information about:

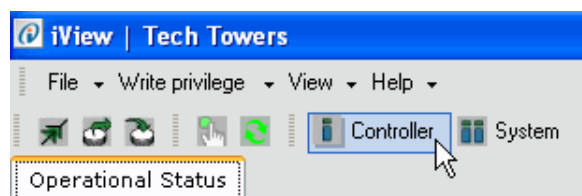
- Selecting Controller view:
- **Controller View Windows and tabs:** A complete list of iView windows and tabs, and information about the parameters on each.

Selecting Controller View

iView is used to view and adjust the Controller and System parameters. iView is divided into two main sections:

- Controller View - used to view and adjust the controller parameters, e.g., Brake, Drive, Pattern, Car Operation, etc. When iView first connects to an iController, the Controller view is displayed.
- System View - used to view and adjust the System parameters, e.g., Dispatching, Parking, Emergency Power, Security, etc. When iView is connected to a central dispatcher (iCentral), the Controller and System buttons are missing and System view is always displayed. [Please refer to “Selecting System View” on page 10-1.](#)

To select Controller view, click the Controller view button at the top of the iView screen.





Controller View Windows and Tabs

The parameters displayed in the Controller view are related to the operation and control of the connected car. Table 9.1 lists the locations where the parameters and settings are explained. If you are viewing this as a PDF file, click the page number link to jump to the description of the parameters on that tab.

Table 9.1 Controller View Windows and Tabs

Windows	Tabs	See
Default	Operational Status	page 9-8
Configuration	Advanced > Custom Outputs	page 9-139
	Advanced > User Events	page 9-138
	Brake	page 9-24
	Car Call Enable	page 9-28
	Car Operation	page 9-29
	Drive	page 9-87
	Floor Heights	page 9-94
	General	page 9-95
	I/O Boards	page 9-100
	iBox Configuration	page 9-125
	Load Weigher	page 9-126
	Pattern	page 9-128
	Terminal Switches	page 9-134
	Timer Tables	page 9-135
Diagnostics	Data Trap	page 9-11
	Diagnostic Flags	page 9-12
	Diagnostic Outputs	page 9-13
	Event Log	page 9-14
	Fault Bypass	page 9-17
	Terminal Switches	page 9-19
	Virtual Oscilloscope	page 9-21
Setup	Brake	page 9-140
	Counterweight	page 9-140
	Drive	page 9-142
	Floor Heights	page 9-143
	Load Weigher	page 9-146
	Safety	page 9-147
	Terminal Switches	page 9-151
Hoistway		page 9-4
Safety Tests		page 9-152
Layouts	Configuration	page 9-153
	Diagnostics	
	Default	
	Brake	
	Drive	
	Floor Heights	
	Load Weigher	
	Motor Field	
	Terminal Switches	
	Custom	

iView Button Bar

Table 9.2 lists the locations where the functions of the buttons are explained.

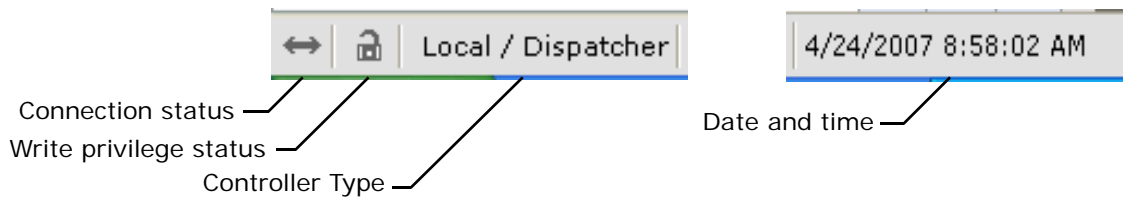


Table 9.2 Buttons and Dialogs

Buttons / Dialogs	Description	See
Open Connection	Displays the Open dialog	page 8-11
Open Configuration File	Displays the Open Configuration File dialog	page 8-22
Save Configuration File	Displays the Save Configuration File dialog	page 8-20
Call Registration	Place car calls and hall calls	page 9-154
Refresh	Refreshes the parameters being displayed	
Firmware Update	Update the iBox imbedded firmware	page 9-155
Controller	Causes the Controller view to be displayed	page 9-1
System	Causes the System view to be displayed	page 10-1

iView Status Bar

The status bar at the bottom of the iView screen provides the following information:



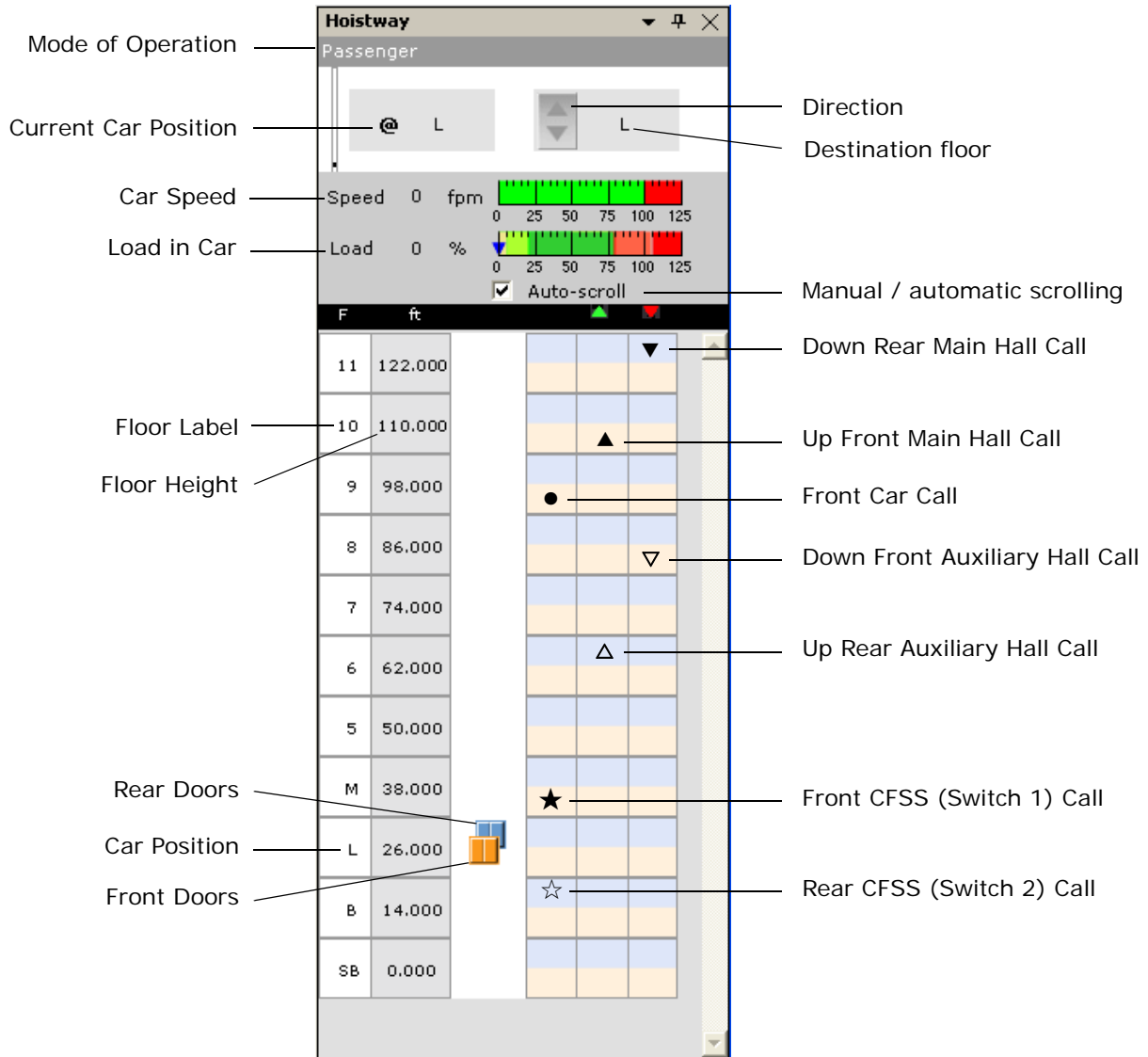
Connection Status Connected arrows, shown above, indicate that iView is communicating with the controller. Broken arrows indicate that the connection has been broken.

Write Privilege Status/Time Remaining An unlocked lock, shown above, indicates that this connection does not have write privilege. A locked lock indicates that write privilege has been granted, and the time remaining before timeout is displayed.

Controller Type Indicates the type of controller to which iView is connected. For a description of each type see “An Overview of System Options” on page 10-4 The controller types include:

- Simplex - a single car that is not part of a group.
- Local - a car that is part of a group.
- Local (Swing) - a local car that can swing away (detach from the group).
- Swing - a local car that is currently detached from the group and is acting like a simplex.
- Local (Alternate Dispatcher) - a local car that can assume dispatching responsibilities.
- Local / Dispatcher - a local car that is also currently the dispatcher. iCue dispatching software is running on the local car’s iBox.
- iCentral - a central dispatcher with iCue dispatching software running on a dedicated PC or embedded micro controller.

Hoistway window



The Hoistway pane shows the following:

- Position of the car in the hoistway
 - Real time position of the doors
 - Floor labels
 - Registered calls assigned to this car
 - Floor heights (distance from lowest landing)
 - Load in car - % of full load:
 - Yellow = Empty load
 - Light Green = Light load
 - Light Red = Heavy load
 - Red = Overload
- Mode of operation
 - Direction of travel
 - Destination floor
 - Car speed

Mode of Operation

The top line of the Hoistway pane shows the current car operation mode:

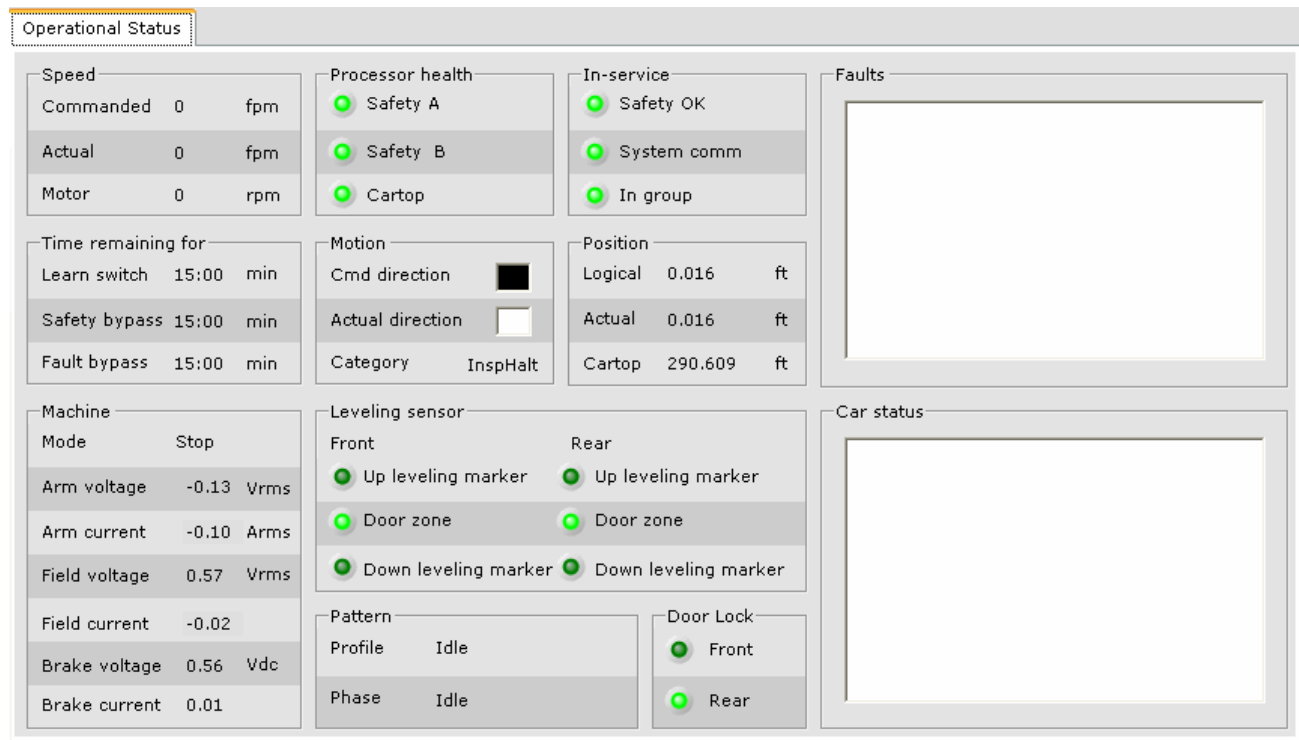
- **Attendant Service:** The car is operating in Attendant service mode. Usually initiated by a key-operated switch inside the car to allow the elevator to be operated by an in-car Attendant. While on Attendant service, hall and car call buttons remain active. The elevator will respond to car calls that have been enabled via different settings as specified by the car call eligibility and card reader options. During Attendant service, the Attendant inside the car controls direction of travel using the Attendant service Up and Down switches. The Attendant can also bypass hall calls using the Attendant service Non-Stop switch. Door operation is typically automatic open with constant pressure on the door close button required to close the doors. However, user settings are available to modify door operation if desired. The parameters and descriptions are the same as for the Independent Service > Front / Rear tabs. [Please refer to “Car Operation - Independent Service Tab” on page 9-59.](#)
- **Capture:** The car has been placed in Capture mode using the Capture switch on the iBox or by activating the Capture Input. When placed in Capture mode the car is taken “out” of public service. It will not respond to hall call demand or parking instructions. It will continue to service car call demand so that current passengers are not inconvenienced. The intent is to allow the car to service current passengers and then remain empty at the last serviced floor so that it may be captured for test, adjustment, or other non-passenger use.
- **Car Panel Inspection:** The car has been placed on Inspection mode using the car operating panel switch. Use the car panel inspection switches to move the car.
- **Cartop Inspection:** The car has been placed on Inspection mode using the cartop switch. Use the cartop Up, Down and Safe switches to move the car.
- **CFSS Mode 1 (2) at Floor: Commander for Special Services -** The car has recalled to the CFSS floor and is waiting for a person to commandeer it according to the settings selected on the Configuration > Car Operation > CFSS > Mode 1 (2) tab. [Please refer to “Car Operation - CFSS Tab” on page 9-73.](#)
- **CFSS Mode 1 (2) In-car: Commander for Special Services -** The in-car switch has been activated (or the car is at the recall floor if no switch). Car behavior is determined by the In-car settings on the Configuration > Car Operation > CFSS > Mode 1 (2) tab. [Please refer to “Car Operation - CFSS Tab” on page 9-73.](#)
- **CFSS Mode 1 (2) Recall: Commander for Special Services -** A CFSS call has been initiated via a hall switch. Any other hall calls will be un-assigned from the car. Any existing car calls will be disposed of according to the Recall settings selected on the Configuration > Car Operation > CFSS > Mode 1 (2) tab and the car will then recall to the floor at which the CFSS call was latched. [Please refer to “Car Operation - CFSS Tab” on page 9-73.](#)
- **Construction Car Panel Inspection:** Construction mode is enabled (Configuration > Safety tab), and the car operation panel inspection switch has been activated. However, while in Construction mode, the car panel inspection switches are ignored. The car can only be operated via the machine room or cartop inspection switches while in Construction mode.
- **Construction Cartop Inspection:** Construction mode is enabled (Configuration > Safety tab), allowing the car to be run on Inspection with a bare minimum of field wiring installed, and the cartop Inspection switch has been activated. Use the cartop Up, Down and Safe switches to move the car. Place the car on machine room or cartop inspection and operate the car with the appropriate switches.

- **Construction Hoistway Access Inspection:** Construction mode is enabled (Configuration > Safety tab), and the hall mounted Access switch has been activated. However, while in Construction mode, the hoistway access inspection switches are ignored. The car can only be operated via the machine room or cartop inspection switches while in Construction mode. Place the car on machine room or cartop inspection and operate the car with the appropriate switches.
- **Construction Inspection:** Construction mode is enabled (Configuration > Safety tab), allowing the car to be run on Inspection with a bare minimum of field wiring installed, and the car is therefor operating on Inspection operation. The car can be moved using either the cartop or machine room inspection operation switches.
- **Construction Machine Room Inspection:** Construction mode is enabled (Configuration > Safety tab), allowing the car to be run on Inspection with a bare minimum of field wiring installed, and the iBox INSPECTION switch has been placed in the INSP position. Use the iBox Up, Down and Enable switches to move the car.
- **EMS In-car (Switch 1 / 2):** Emergency Medical Service - The EMS in-car switch has been activated. The car remains on EMS operation until it is returned to the recall floor and the in-car switch is deactivated.
- **EMS Recall (Switch 1 / 2):** Emergency Medical Service has been activated via a hall switch (1 or 2). Car behavior, including the designated recall floor, are determined by the General settings on the Configuration > Car Operation > EMS > Switch 1 (2) tab. [Please refer to “Car Operation - EMS Tab” on page 9-66.](#)
- **Fire Service In-car:** In-car Firefighter's Service has been activated via the in-car fire service key-switch. Car and door behavior is determined by the fire code settings on the Configuration > Car Operation > Fire service > Fire code > In-car tab. [Please refer to “Fire Code - In-Car - General Tab” on page 9-52.](#)
- **Fire Service Recall Alternate:** Fire Recall Operation (Phase I), to the alternate fire recall floor has been initiated. Generally this is initiated by the activation of a smoke detector at the main fire recall floor. The car proceeds to the alternate fire recall floor designated on the Configuration > Car Operation > Fire service tab. Car and door behavior is determined by the fire code settings on the Configuration > Car Operation > Fire service > Fire code > Recall tab. [Please refer to “Fire Code - Recall - General Tab” on page 9-47.](#)
- **Fire Service Recall Main:** Fire Recall Operation (Phase I), at the main fire recall floor, has been initiated. Generally this is initiated by the activation of a smoke detector on a floor other than the main fire recall floor. Can also be initiated by the activation of the fire recall switch input. The car proceeds to the main fire recall floor designated on the Configuration > Car Operation > Fire service tab. Car and door behavior is determined by the fire code settings on the Configuration > Car Operation > Fire service > Fire code > Recall tab. [Please refer to “Fire Code - Recall - General Tab” on page 9-47.](#)
- **Hoistway Access:** The car has been placed on Hoistway Access Inspection mode using one of the hall panel mounted switches. The car can be positioned to allow access to the cartop or bottom.

- **Independent Service:** Independent service is usually initiated by a key-operated switch inside the car to allow the elevator to be operated by an in-car Attendant. While on Independent service, hall call buttons and lamps for the elevator are disabled. The elevator will respond only to car calls that have been enabled via different settings as specified by the car call eligibility and card reader options. Door operation is typically automatic open with constant pressure on the door close button required to close the doors. However, user settings are available to modify door operation if desired. [Please refer to “Car Operation - Independent Service Tab” on page 9-59.](#)
- **Inspection:** One of the inspection modes (in-car, machine room or cartop) is active and the car is operating in Inspection mode. The Inspection profile parameters are used.
- **Machine Room Inspection:** The car has been placed on Machine Room Inspection mode using the iBox Inspection switch. (All other Inspection modes must be inactive before Machine Room Inspection may be enabled.)
- **Passenger:** The car is operating in normal passenger mode, responding to dispatching and parking instructions and to hall and car call demands. Car and door operation are determined by settings on the Configuration > Car Operation > Passenger tab. [Please refer to “Car Operation - Passenger Tab” on page 9-37.](#)
- **Sabbath Operation:** The elevator is operating in Sabbath mode initiated by a software command, switched input or timer. Sabbath mode allows the elevator to operate, serving the building without requiring buttons to be pressed for hall calls or car calls. Car behavior is determined by parameters located on the Configuration > Car Operation > Sabbath operation tab. [Please refer to “Car Operation - Sabbath Tab” on page 9-81.](#)
- **Shuttle service:** The elevator is operating in Shuttle service mode initiated by a key-switch/ input, software command or timer. This option allows the car to be used to provide express service for a subset of the building’s floors. Car behavior is determined by parameters located on the Configuration > Car Operation > Shuttle service tab. [Please refer to “Car Operation - Shuttle Service” on page 9-84.](#)
- **Test:** Indicates that the iBox Test switch is in the Test position and the elevator is in Test mode, generally used to adjust or test the elevator. The elevator operates the same as in normal passenger mode except that the doors are disabled and no hall calls are registered.

Operational Status tab

The Operational Status tab is displayed, along with the Hoistway pane, when iView first connects to an iController.



Speed		
Commanded	0	fpm
Actual	0	fpm
Motor	0	rpm

Processor health	
Safety A	●
Safety B	●
Cartop	●

In-service	
Safety OK	●
System comm	●
In group	●

Time remaining for	
Learn switch	15:00 min
Safety bypass	15:00 min
Fault bypass	15:00 min

Motion	
Cmd direction	
Actual direction	
Category	InspHalt

Position	
Logical	0.016 ft
Actual	0.016 ft
Cartop	290.609 ft

Machine	
Mode	Stop
Arm voltage	-0.13 Vrms
Arm current	-0.10 Arms
Field voltage	0.57 Vrms
Field current	-0.02
Brake voltage	0.56 Vdc
Brake current	0.01

Leveling sensor			
Front		Rear	
Up leveling marker	●	Up leveling marker	●
Door zone	●	Door zone	●
Down leveling marker	●	Down leveling marker	●

Pattern	
Profile	Idle
Phase	Idle

Door Lock	
Front	●
Rear	●

Speed

- **Commanded:** The speed commanded by the control system
- **Actual:** The actual car speed determined by the landing system encoder.
- **Motor:** Speed determined by the motor encoder/tachometer.

Processor health

- **Safety A:** Indicates that Safety processor A is ok.
- **Safety B:** Indicates that Safety processor B is ok.
- **Cartop:** Indicates that the Cartop processor is ok.

In-service

- **Safety OK:** Indicates that the safety string is made up.
- **System communication:** Indicates that system communication is ok.
- **In group:** Indicates that the car is operating under group dispatcher control.

Time Remaining for

- **Learn switch:** Time remaining until the Learn switch timer elapses. Reset the timer by toggling the iBox LEARN switch OFF and then back to ON.
- **Safety bypass:** Time remaining until the Safety bypass timer elapses. Reset the timer by removing and then reinstalling the jumper (SB to 3 on the iBox).
- **Fault Bypass:** Time remaining until the Fault bypass timer elapses. Reset the timer by toggling the iBox FAULT/FUNCTION BYPASS switch to OFF and then back to ON.

Motion

- **Cmd direction (Commanded direction):** Indicates the car's commanded direction of travel.
- **Actual direction:** Indicates the car's actual direction of travel.
- **Category:** (Note: Insp = Inspection mode, all others = Automatic (Passenger) mode.)
 - **AutoHalt:** An emergency stop has been initiated.
 - **AutoIdle:** Waiting for a request to move to a different floor or relevel at current floor.
 - **AutoWait:** Waiting for the actual speed to indicate that the car has stopped moving.
 - **InspHalt:** An emergency stop has been initiated.
 - **InspIdle:** Waiting for a request to move.
 - **InspMove:** Received permission to move and movement initiated.
 - **InspStart:** Received a request to move and determined it is safe to do so.
 - **InspStop:** A normal stop has been initiated.
 - **InspWait:** Waiting for the actual speed to indicate that the car has stopped moving.
 - **LevMove:** Received permission to relevel and movement initiated.
 - **LevStart:** Received a request to relevel and determined it is safe to do so.
 - **LevStop:** While releveling, a normal stop has been initiated.
 - **RunMove:** Received permission to move and movement initiated.
 - **Run Slow:** Slowdown has been initiated.
 - **RunStart:** Received a request to move and determined it is safe to do so.
 - **RunStop:** A normal stop has been initiated.

Position

- **Logical:** The idealized position of the car. Indicates where the car would stop if so commanded, taking into account current speed and deceleration rate.
- **Actual:** The true position of the car reported by the position encoder.
- **Cartop:** Raw position from cartop, no offset included.

Machine

- **Mode:**
 - **Brake Contact Enable:** The contactor for the brake subsystem has been energized. Voltage is available at the input of the brake subsystem.
 - **Brake Electric Enable:** The brake subsystem has been enabled. Along with an energized brake contactor, the brake subsystem is able to produce brake output voltage.
 - **Drive Electric Enable:** The drive subsystem has been enabled. Along with an energized motor contactor, the drive system is able to produce output voltage (armature voltage).
 - **Motor Contact Enabled:** The contactor for the drive subsystem has been energized. Voltage is available at the input of the drive subsystem.
 - **Run:** The system has received permission to energize the motor and has done so.
 - **Start:** The system has received a request to energize the motor and determined that it is safe to do so.
 - **Stop:** The system has begun the process to de-energize the motor.
- **Arm voltage (Armature voltage):** Voltage applied to the armature.
- **Arm current (Armature current):** Armature current expressed as a function of voltage.

- Field voltage: Actual voltage applied to the motor field. (DC only)
- Field current: Value proportional to the current flowing through the motor field (DC only).
- Brake voltage: Actual voltage applied to the brake.
- Brake current: A value proportional to the actual current flowing through the brake.

Door lock

- Front and Rear: Indicates when the front and rear door locks are made up.

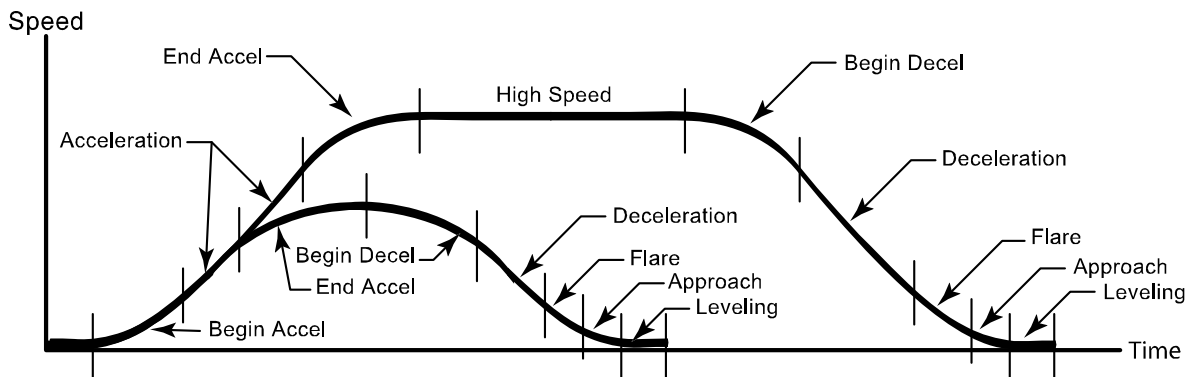
Leveling sensor

- Up leveling marker (Front and Rear): Indicates when front and rear Up leveling markers sensors are On.
- Door zone (Front and Rear): Indicates when front and rear door zone sensors are On.
- Down leveling marker (Front and Rear): Indicates when front and rear down leveling marker sensors are On.

Pattern

- Profile:

• Alternate 1	Emergency Power	Idle
• Alternate 2	Earthquake	Inspection
• Correction	Emergency slowdown	Standard
- Phase: (Please see the graphic below)
 - Idle
 - Begin Accel
 - Acceleration
 - End Accel
 - High Speed
 - Begin Decel
 - Deceleration
 - Flare
 - Approach Leveling



Faults

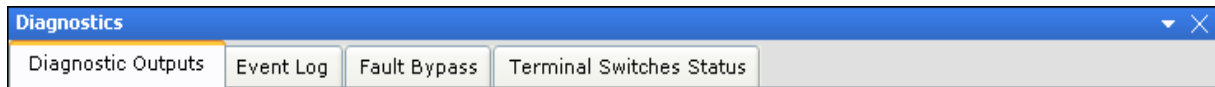
- All active fault messages are displayed in the Faults list box. A complete listing of fault messages is provided in Section 6. [Please refer to “iControl Messages” on page 6-13.](#)

Car status

- All active car status messages are displayed in the Car status list box. A complete listing of status messages is provided in Section 6. [Please refer to “iControl Messages” on page 6-13.](#)

Diagnostics Tabs

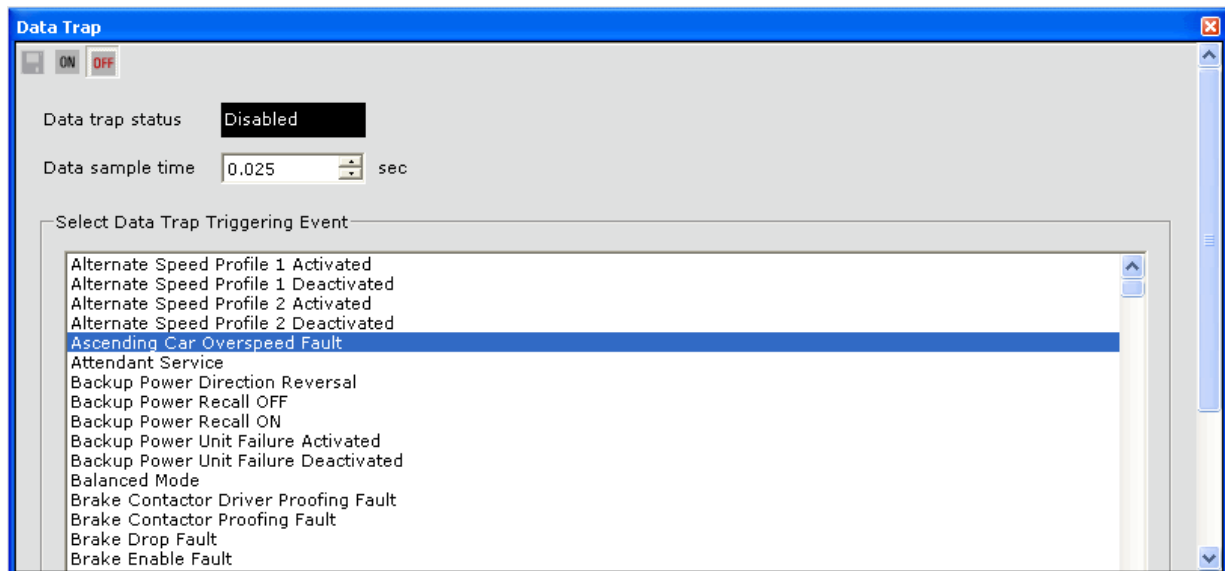
The following four Diagnostics tabs can be displayed one at a time by selecting each one from the Controller > Diagnostics menu or they can all be displayed by selecting Diagnostics from the Controller > Layouts menu.



Three other diagnostic screens, Data Trap, Diagnostic Outputs and Virtual Oscilloscope, are displayed each in their own window. This allows them to be used simultaneously with other windows.

Diagnostics - Data Trap

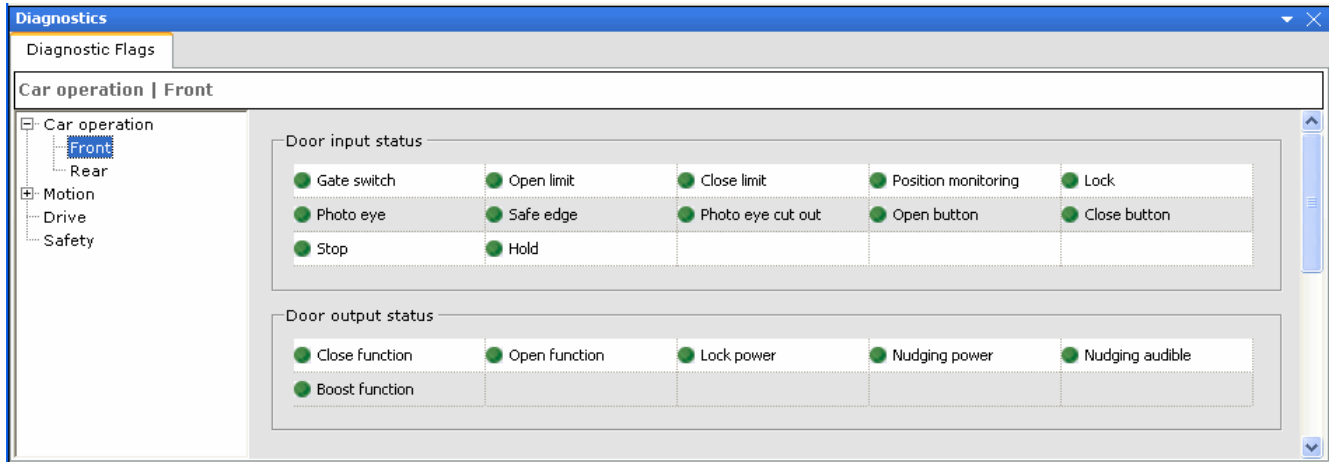
The data trap diagnostic tool allows you to record and analyze controller data including input and output states, internal flags and parameter values. When the trap is ON (Running), the controller samples data at specified intervals (Data sample time). The most recent 500 samples are retained in a buffer. The user selects a specific event to "trigger" the data trap. When the selected event occurs, sampling stops and the data in the buffer can be saved to disk and then viewed. The data leading up to the event can be examined to help diagnose controller problems.



- **ON/OFF buttons:** Click the ON button to turn the data trap ON. The *Data trap status* changes to *Running*. Click the OFF button to turn the data trap OFF. The *Data trap status* changes to *Disabled*.
- **Data trap status:** Indicates the status of the data trap, Disabled or Running.
- **Data sample time:** Sets the duration of the data sample.
- **Select Data Trap Triggering Event:** Select from the list of signals and events and then Send to the controller.
- **Save button:** Once the data trap has been triggered, the Data trap status changes to *Disabled (OFF)* and no further samples are taken. Click the *Save* icon to display the Save dialog box. Choose a name and a location for the file and click *Save*. The saved files (.csv) can be viewed using a spreadsheet program such as Microsoft Excel.

Diagnostics - Diagnostic Flags

During an elevator run, a number of “events” occur in a particular sequence. Examining this sequence is useful in determining the status of the elevator. The Diagnostics flags provide a near real-time, graphical display of system diagnostic flags. LEDs indicating currently active flags are lighted.

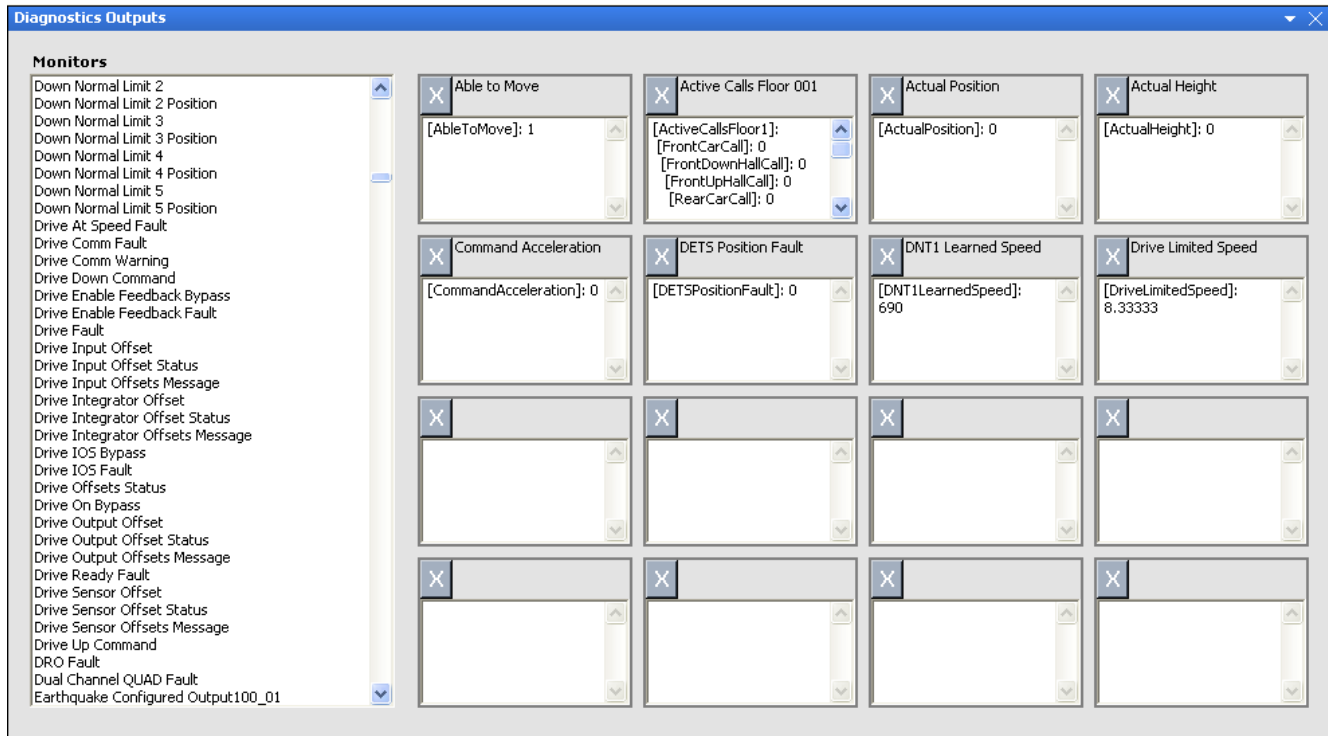


The tree in the left pane allows you to view the status of input and output flags arranged into four groups:

- **Car Operation:** Active car and hall calls, direction of travel, recall status, parking status flags, OK to start status, etc.
- **Motion:** Operational flags that determine whether or not the elevator is “allowed” to move.
- **Drive:** Run state flags for drive and motor.
- **Safety:** Safety flags.

Diagnostics - Diagnostic Outputs

The Diagnostic Outputs pane allows you to select from hundreds of system outputs and display those outputs (up to sixteen at a time) on the screen for easy monitoring.



To select outputs to monitor:

- Click an output in the table on the left and drag it into the title bar of one of the sixteen output monitors. The value of that output will appear in the window below the title bar.

To remove an output being monitored:

- Click the “X” next to the output’s name in the title bar of the monitor.

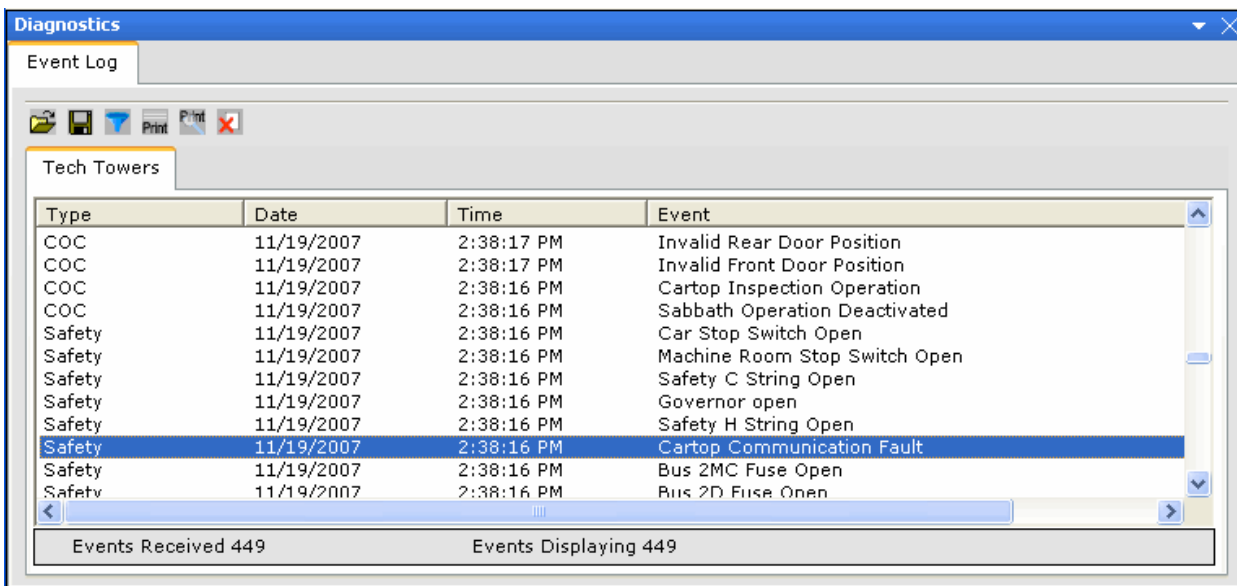
Diagnostics - Event Log

The Event Log (Controller > Diagnostics > Event Log) provides a way to view controller events logged by iControl. This is an invaluable troubleshooting tool. A complete listing of iControl messages, a description and trouble shooting tips can be found in Section 6 and in the iView on-line help. [Please refer to “iControl Messages” on page 6-13.](#)

The Controller Event Log lists the following for the events recorded:

- Type of event Time
- Date Event


Events may be sorted by any of the above by clicking the column heading.




Type	Date	Time	Event
COC	11/19/2007	2:38:17 PM	Invalid Rear Door Position
COC	11/19/2007	2:38:17 PM	Invalid Front Door Position
COC	11/19/2007	2:38:16 PM	Cartop Inspection Operation
COC	11/19/2007	2:38:16 PM	Sabbath Operation Deactivated
Safety	11/19/2007	2:38:16 PM	Car Stop Switch Open
Safety	11/19/2007	2:38:16 PM	Machine Room Stop Switch Open
Safety	11/19/2007	2:38:16 PM	Safety C String Open
Safety	11/19/2007	2:38:16 PM	Governor open
Safety	11/19/2007	2:38:16 PM	Safety H String Open
Safety	11/19/2007	2:38:16 PM	Cartop Communication Fault
Safety	11/19/2007	2:38:16 PM	Bus 2MC Fuse Open
Safety	11/19/2007	2:38:16 PM	Bus 2D Fuse Open

Events Received 449 Events Displaying 449



Save event log / Open event log The Event Log can be saved to a file for future reference. To save a Controller Event Log to a file:

- Click the Save button  on the Controller > Diagnostics > Event Log tab.
- Navigate to the folder you want to save the file in.
- Name the file and click Save.

The Event Log file can be viewed using iView. To view a previously saved Event Log file:

- Click the Open file button  on the Controller > Diagnostics > Event Log tab.
- Navigate to the file you want to view and double-click it.

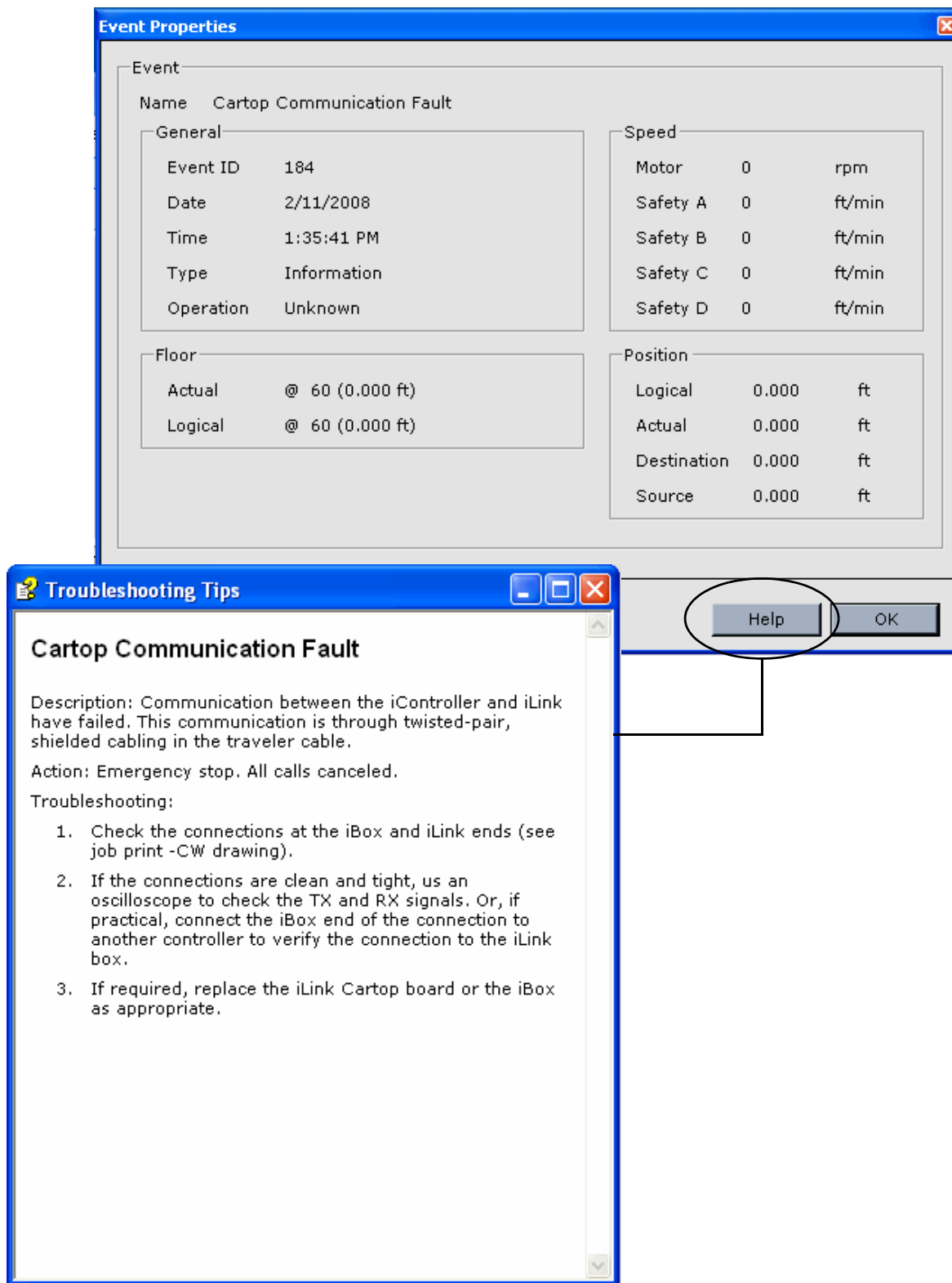
Print / Print Preview To print the event log or to view a print preview and/or print the event log from the print preview dialog:

- Click the Print button , choose a printer from the Print dialog and click Print.
- Click the Print Preview button  and use the controls to display and/or print the desired pages.


Clear All Click the Clear All button  to delete all of the events in the Event Log.

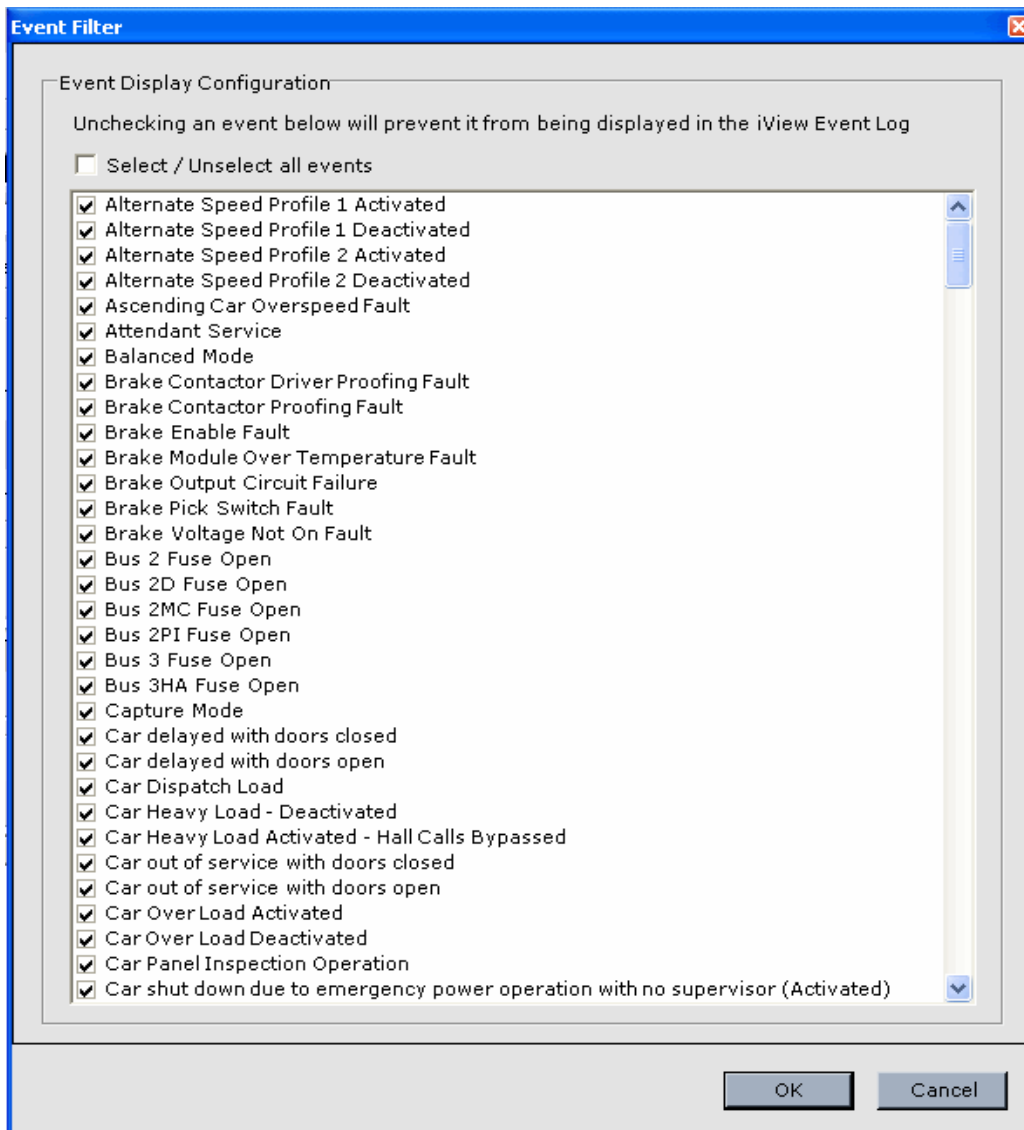
Event Properties To view greater detail about an event:

- Double-click the event in the Event Log. The Event Properties dialog is displayed.
- Click **Help** in the Event Properties dialog. The Troubleshooting Tips dialog is displayed



Event Filter The Event Filter controls which events will be displayed in iView.

- Click the  button on the Event Log tab. The check events will be displayed.
- Click to remove the check mark from events that you don't want displayed.
- Click again to add a check mark to events that you want to be displayed.

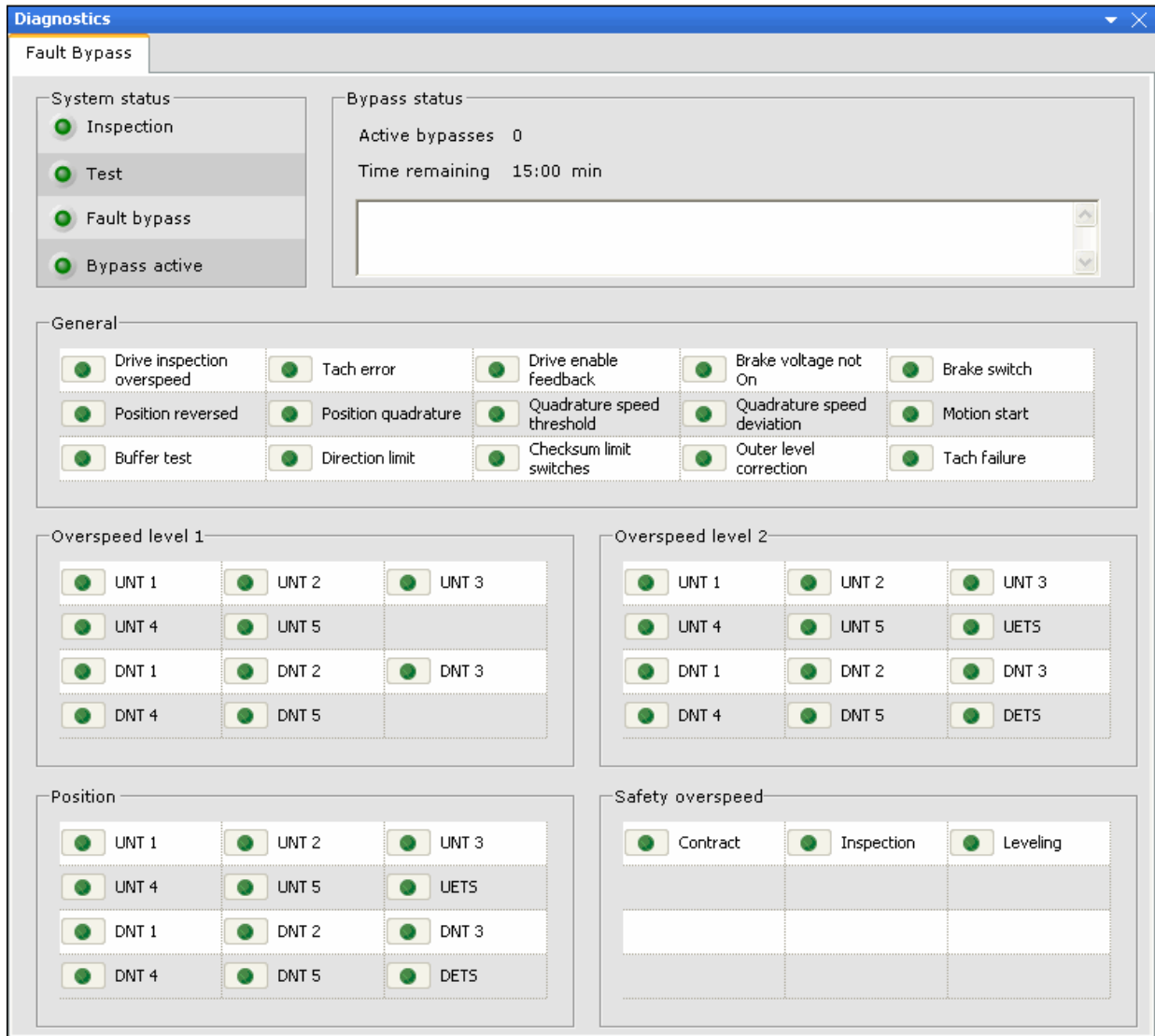


Events Received Shown at the bottom of the Event Log window, this indicates the number of events that have been received from the controller.

Events Displaying This indicates the number of events that are being displayed. By comparing the Events Received versus the Events Displaying, you can determine how many events are being filtered out by the Event Filter.

Diagnostics - Fault Bypass

The Fault Bypasses allow you to temporarily bypass the normal system reaction to certain faults. This can be helpful when diagnosing system problems or operating the elevator under abnormal conditions. Bypasses can only be activated when not on normal (passenger) operation.



To bypass faults:

1. In iView, display the Diagnostics > Fault Bypass tab. The message window provides instructions.
2. Set the iBox INSPECTION switch to the INSP position (or set the TEST switch to ON).
3. Set the iBox FAULT/ FUNCTION BYPASS switch to ON. (see "Time remaining" below)
4. When the message window indicates "ABLE TO BYPASS FAULTS" click the button(s) for the fault(s) you wish to bypass. The LEDs on the buttons turn on when the bypass is active, off when a bypass is inactive and the buttons are grayed out when a bypass is unavailable.

System status

- Inspection - lights when the iBox INSPECTION switch is in the INSP position.
- Test - lights when the iBox TEST switch is ON.
- Fault bypass - lights when the iBox FAULT/FUNCTION BYPASS switch is ON.
- Bypass active - lights when any fault bypass is active.

Bypass status

- Active bypasses - indicates the number of active bypasses.
- Time remaining - the bypass remains active for fifteen minutes from the time the iBox Fault/ Function Bypass switch is turned ON. This display indicates the remaining time. When the time elapses, the message window indicates “FAULT BYPASS SWITCH TIMED OUT”. If you need additional time, turning the Fault/Function Bypass switch to OFF and then back to ON within one second will reset the selected bypasses.
- Message window - shows instructional information.

Fault Bypasses The following bypasses are provided. When enabled, the fault will be ignored and the system will not respond to the fault as programmed.

Table 9.3 Fault Bypasses

Drive inspection overspeed	Tech error
Drive enable feedback	Brake voltage not on
Brake switch	Position reversed
Position quadrature	Quadrature speed threshold
Quadrature speed deviation	Motion start
Buffer test	Direction limit
Limit switch checksum	Outer level Correction
UNT1 through 5 Level 1 Overspeed	DNT1 through 5 Level 1 Overspeed
UNT1 through 5 Level 2 Overspeed	DNT1 through 5 Level 2 Overspeed
UETS Level 2 Overspeed	DETS Level 2 Overspeed
UNT1 through UNT5 Position	DNT1 through DNT5 Position
UETS Position	DETS Position
Safety Contract Overspeed	Safety Inspection Overspeed
Safety Leveling Overspeed	Tach Failure

Diagnostics - Terminal Switches Status

The Terminal Switches Status shows information about the speed and position of the car when each Normal Terminal Switch (U/DNT1 - U/DNT5) and Emergency Terminal Switch (U/DETS) opened. The parameters are divided into the following groups:

- Switch data: U/DNT1 through U/DNT5: Speed and position parameters for Up and Down Normal Terminal Switches 1 through 5. Also, U/DETS: Speed and position for the Emergency Terminal Switches.
- Position at speed transition points - Last run: Car position at various speed transition points during the last run.

Diagnostics
✕

Terminal Switches Status

Switch data

	Position (ft)				Speed (ft/min)			
	Learned	Lower limit	Upper limit	Last pass	Learned	Over speed 1	Over speed 2	Last pass
UNT 5 ●	0.000	-2.000	2.000	0.000	394.00	433.00	454.00	0.00
UNT 4 ●	0.000	-2.000	2.000	0.000	394.00	433.00	454.00	0.00
UNT 3 ●	0.000	-2.000	2.000	0.000	394.00	433.00	454.00	0.00
UNT 2 ●	0.000	-2.000	2.000	0.000	394.00	433.00	454.00	0.00
UETS ●	0.000	-2.000	2.000	0.000	234.00		951.00	0.00
UNT 1 ●	0.000	-2.000	2.000	0.000	681.00	749.00	786.00	0.00
DNT 1 ●	0.000	-2.000	2.000	0.000	690.00	759.00	796.00	0.00
DETS ●	0.000	-2.000	2.000	0.000	0.00		951.00	0.00
DNT 2 ●	0.000	-2.000	2.000	0.000	414.00	455.00	477.00	0.00
DNT 3 ●	0.000	-2.000	2.000	0.000	414.00	455.00	477.00	0.00
DNT 4 ●	0.000	-2.000	2.000	0.000	414.00	455.00	477.00	0.00
DNT 5 ●	0.000	-2.000	2.000	0.000	414.00	455.00	477.00	0.00

Position at speed transition points - Last run

100 %	0.000	ft	80 %	0.000	ft
95 %	0.000	ft	75 %	0.000	ft
90 %	0.000	ft	50 %	0.000	ft
85 %	0.000	ft	25 %	0.000	ft

Switch Data

- **Position (ft.)**
 - Learned: Learned position of the car when this switch opened during the Learn operation.
 - Lower limit: Variance below the learned switch position required to generate an Up or Down Normal Terminal Switch (n) Position Fault or an Up or Down Emergency Terminal Switch Position Fault, causing the car to stop using the Emergency Slowdown Profile parameters.
 - Upper limit: Variance above the learned switch position required to generate an Up or Down Normal Terminal Switch (n) Position Fault, causing the car to stop using the Emergency Slowdown Profile parameters.
 - Last pass: Position of the car when this switch opened during the last run.
- **Speed (ft./min.)**
 - Learned: Learned speed of the car when this switch opened during the Learn operation.
 - Overspeed 1: Variance from the learned speed required to generate an Up or Down Normal Terminal Switch (n) Level 1 Speed Fault, causing the car to stop using the Emergency Slowdown Profile parameters.
 - Overspeed 2 (DNT or UNT switch): Variance from the learned speed required to generate an Up or Down Normal Terminal Switch (n) Level 2 Speed Fault, causing the car to perform an Emergency Stop by dropping the brake.
 - Overspeed 2 (DETS or UETS switch): Variance from the learned speed required to generate a Safety A UETS (or DETS) Level 2 Speed Fault, causing the car to perform an Emergency Stop by dropping the brake.
 - Last pass: Speed of the car when this switch opened during the last run.



Note

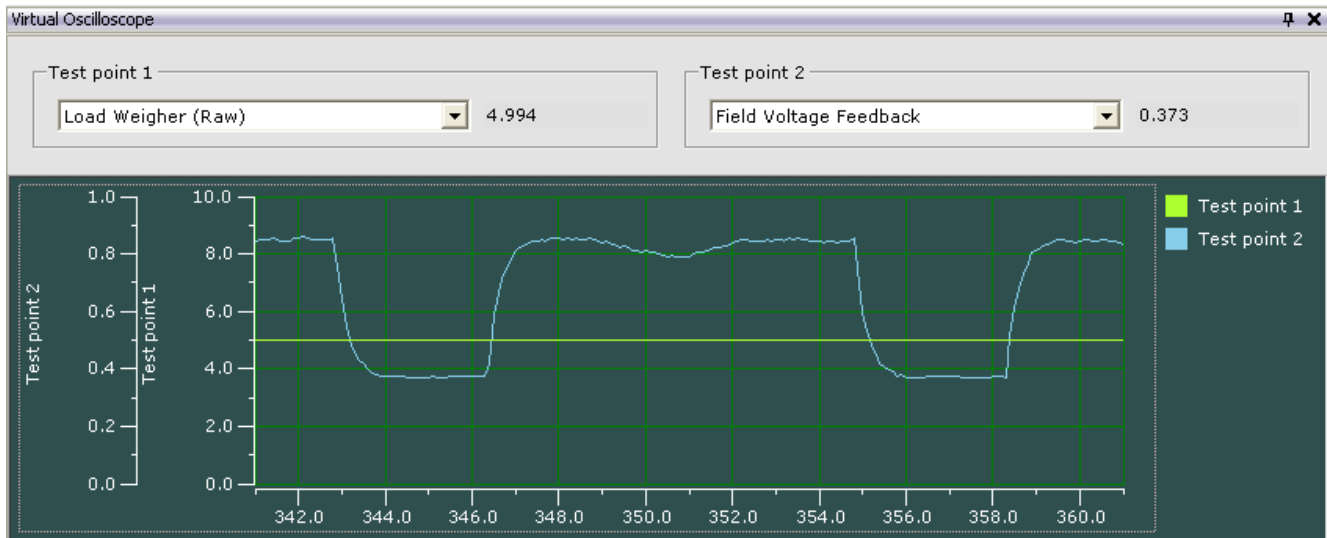
Emergency Terminal Overspeed is hard-coded at 95% of Contract Speed. Be certain that the car is traveling well below this speed when an Emergency Terminal switch is opened to avoid an emergency stop. In some instances, it may be necessary to re-position an Emergency Terminal switch to achieve this. Contact MCE Technical Support if needed.

Position at speed transition points - Last run:

- Position of the car in the hoistway at various speed transition points measured during the last run. These position values can be useful, especially if the last run was to a terminal landing.

Diagnostics - Virtual Oscilloscope

The Virtual Oscilloscope allows you to display and track two signals over time simultaneously. The selected signal values are shown on the Test point 1 and 2 displays and output on the STP 1 and STP 2 physical test points on the iBox.



- Acquire write privileges (select *Acquire* from the *Write privilege* menu).
- Using the drop down list, select the Test point 1 signal. This signal will be tracked in green on the oscilloscope, displayed numerically in the Test point 1 window and output to iBox test point STP1.
- Using the drop down list, select the Test point 2 signal. This signal will be tracked in blue on the oscilloscope, displayed numerically in the Test point 2 window and output to iBox test point STP2.
- You can freeze and reposition the display by clicking and dragging.

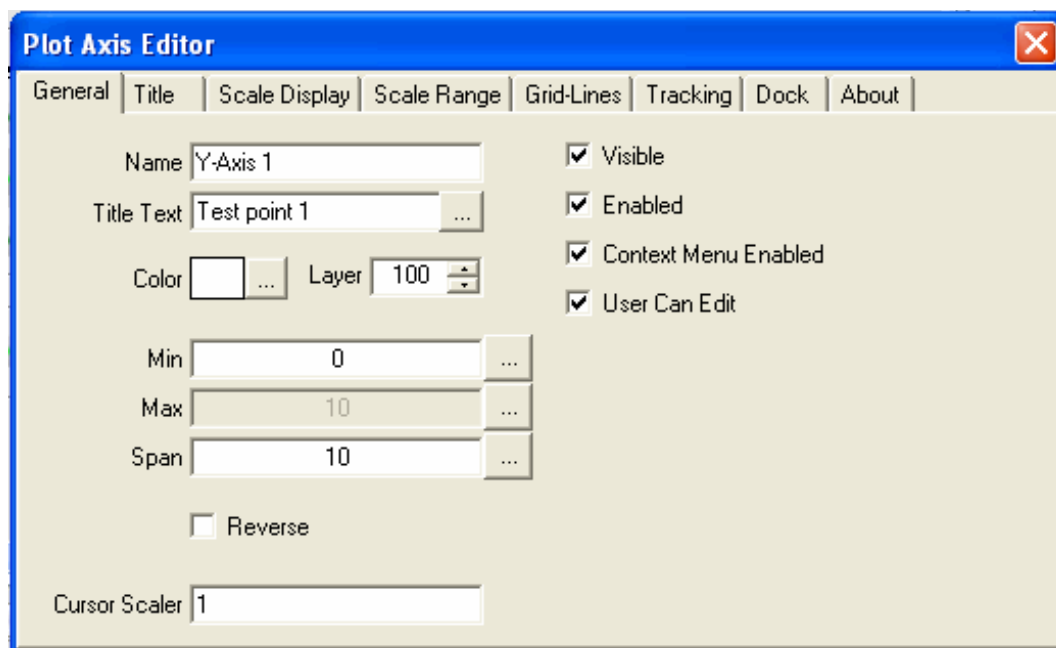
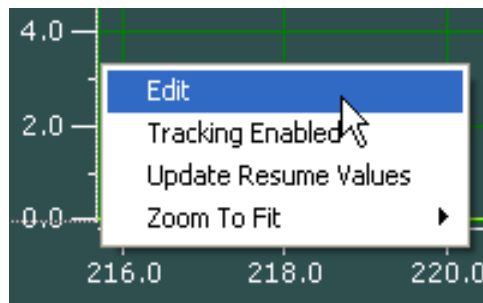
Note

Some signals are scaled, e.g. motor field and brake voltage are scaled by a factor of 100. Other signals are scaled based on parameter values, e.g. pattern High speed (contract speed).

Display Editing

The virtual oscilloscope display is editable. You may easily modify labels, displays, animation, and more to suit your immediate display needs. When a display is closed, then re-opened, it reverts to its default values. To edit a display:

- Right-click on the graph or on one of the scales to reveal a popup menu.
- Select *Edit* from the menu. An editor dialog is displayed. The editor dialog will be different depending on where you click in the oscilloscope display.
- Experiment with modifying the display to find the combinations that suit the signal types you are currently examining. The Edit menu is extensive:

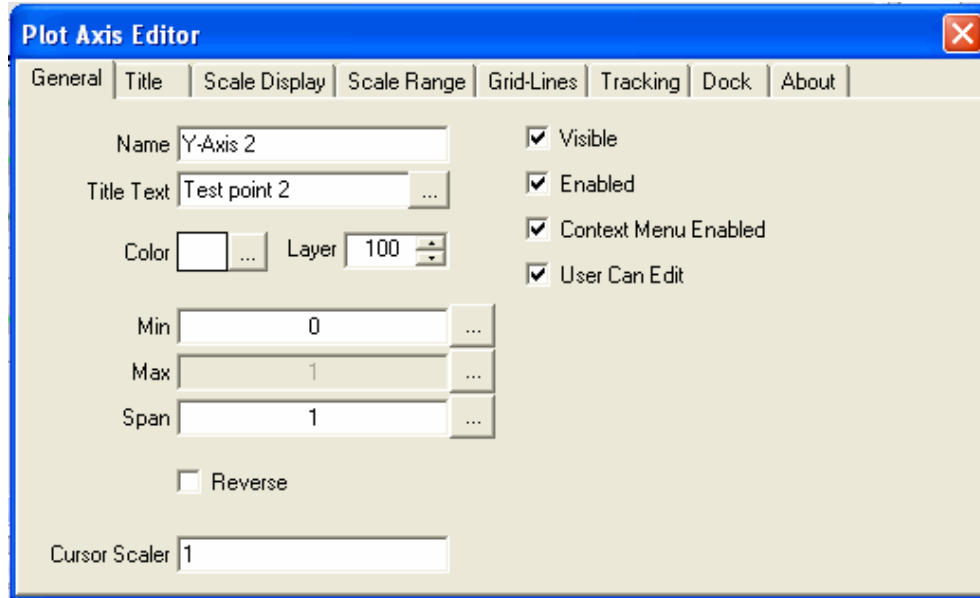


Tracking Enable Tracking from the popup (right-click) menu to track a signal over time. Disable tracking if you want to drag the horizontal scale to look at a particular moment in time.

- Click on a scale, then press the keyboard <Home> to decrement the scale one full “screen.”
- Click on a scale, then press the keyboard <End> key to increment the scale one full screen.
- Click on a scale, then press the keyboard right or left arrow keys to increment or decrement by units.
- While tracking, clicking on any keyboard key will stop tracking.

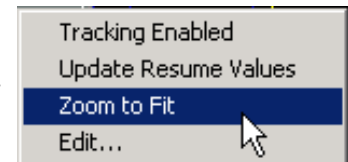
Scale One typical modification you might want to make is to the scale of a display. For example, if you wanted to change the scale of the Test point 2 vertical display (Y axis):

1. Right-click on the Test point 2 display scale and select edit.



2. Set the Minimum value for the scale (Min = zero in our example).
3. Set the Span, number of units to display (Span = one in our example).
4. Close the Plot Axis Editor dialog.

Zoom to Fit Zoom to Fit is another very useful tool. If you are monitoring two signals, and they diverge so that both are not visible, use Zoom to Fit to instantly bring each back into view (vertical scale). Conversely, if two signals are very close together in the display, use Zoom to Fit to expand the display and see fine changes in the signal.

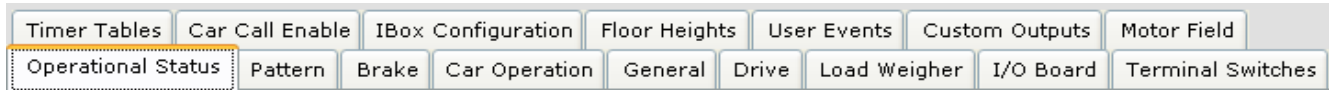


- Right-click on the scale display then select Zoom to Fit.

For the horizontal scale, Zoom to Fit resets the left margin to zero time and scales the display to include total elapsed time at that point. In other words, if you are tracking a signal over time, then want to see all its transitions since you began tracking, use Zoom to Fit on the (lower) horizontal scale.

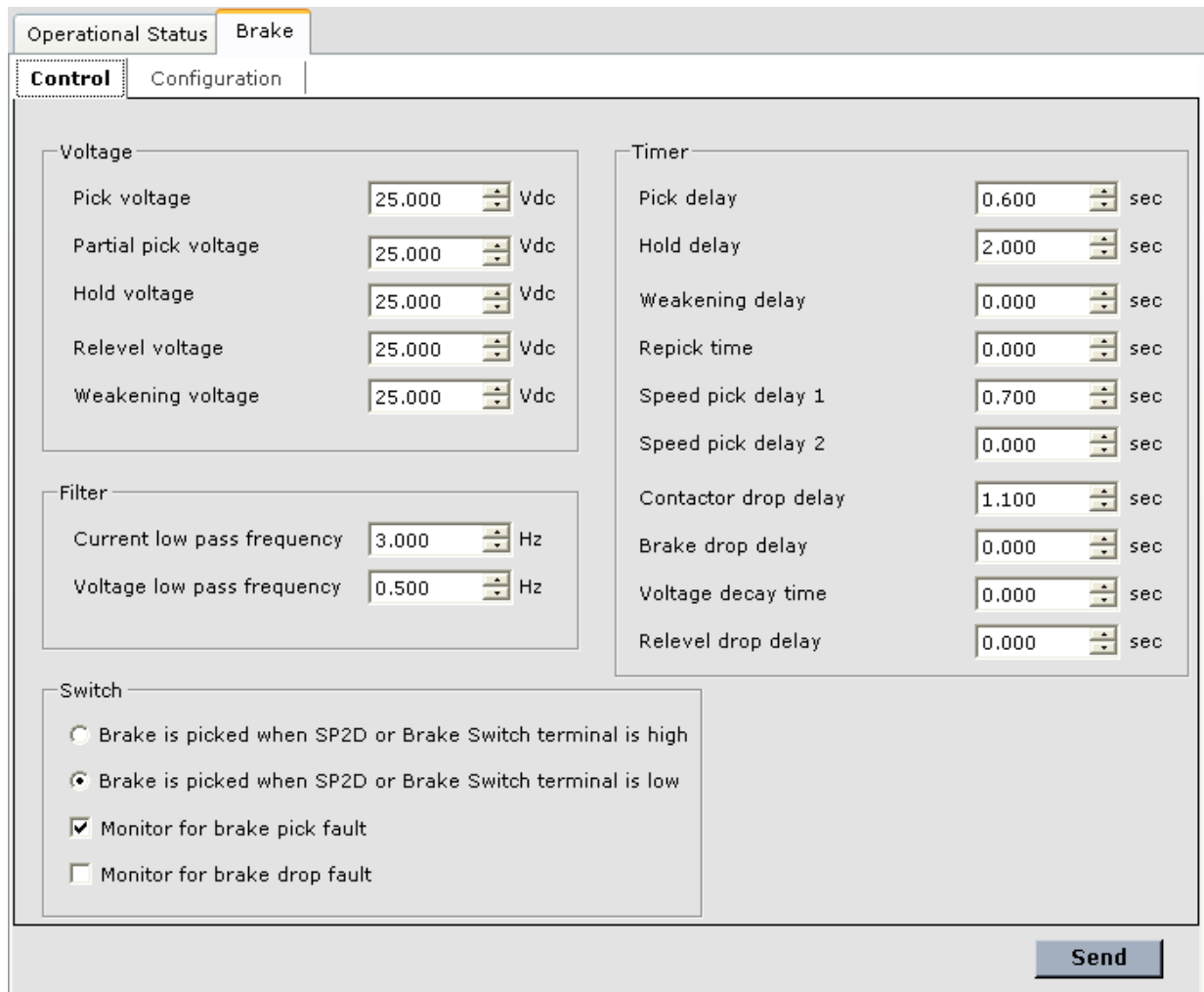
Configuration Tabs

The Controller Configuration tabs are used to view and enter (change) iController parameter values. The Configuration tabs are accessed from the Controller View menu (Controller > Configuration) or you can display all of the configuration tabs by selecting *Configuration* from the Controller > Layouts menu.



Configuration - Brake Tab

The Configuration > Brake tab is used to set the brake voltage and brake timer parameters. Also, on the Brake > Configuration tab, you can view the values determined by the brake setup procedure.



Section	Parameter	Value	Unit
Voltage	Pick voltage	25.000	Vdc
	Partial pick voltage	25.000	Vdc
	Hold voltage	25.000	Vdc
	Relevel voltage	25.000	Vdc
	Weakening voltage	25.000	Vdc
Filter	Current low pass frequency	3.000	Hz
	Voltage low pass frequency	0.500	Hz
Switch	Brake is picked when SP2D or Brake Switch terminal is high	<input type="radio"/>	
	Brake is picked when SP2D or Brake Switch terminal is low	<input checked="" type="radio"/>	
	Monitor for brake pick fault	<input checked="" type="checkbox"/>	
	Monitor for brake drop fault	<input type="checkbox"/>	
Timer	Pick delay	0.600	sec
	Hold delay	2.000	sec
	Weakening delay	0.000	sec
	Repick time	0.000	sec
	Speed pick delay 1	0.700	sec
	Speed pick delay 2	0.000	sec
	Contact drop delay	1.100	sec
	Brake drop delay	0.000	sec
	Voltage decay time	0.000	sec
Relevel drop delay	0.000	sec	

Send

Brake - Control Tab - Voltage

The Brake Control tab allows you to set brake operating voltage outputs. [Please refer to “Brake Parameter Adjustments” on page 4-20.](#)

- **Pick voltage:** Enter the necessary brake Pick voltage (from the job prints) for the brake used on this job.
- **Partial pick voltage:** Applied only if a “While doors are closing with motor and partially picked brake” pre-start sequence is selected. Under this restricted condition, it is only applied if the motor and brake contactor are picked before the door locks make up. If partial pick voltage is applied, full pick voltage will be applied after the door locks make up and Speed pick delay 1 expires. Under this scenario, Speed pick delay 2 needs to expire after full pick voltage is applied before the elevator is allowed to move. When partial pick voltage is applied, the brake should still apply some pressure on the brake drum.
- **Hold voltage:** After the brake picks, the brake voltage will change from Pick voltage to Hold voltage. This is the brake “cooling” voltage. Set Hold voltage = Pick voltage, if not used.
- **Relevel voltage:** The desired brake releveling voltage. This voltage must be sufficient to reduce brake pressure so the car can relevel under the brake. On gearless machines it is important to partially reduce brake pressure, therefore, Relevel voltage should be less than Pick voltage, usually about 50%. [Please refer to “Releveling Operation” on page 4-29.](#)
- **Weakening voltage:** Used to smoothly pick the brake when there is rollback. Set Weakening voltage = Pick voltage, if not used.

Brake - Control Tab - Filter

The Brake > Control tab - Filter section allows you to adjust the filters associated with brake operation.

- **Current low pass frequency:** This parameter adjusts the amount of filtering (smoothing) that is applied to the analog brake current feedback. Generally the default value does not need to be modified. If a change is required, a reduction of the default value will most likely be needed.
- **Voltage low pass frequency:** This parameter adjusts the amount of filtering (smoothing) that is applied to the analog brake voltage feedback. Generally the default value does not need to be modified. If a change is required, a reduction of the default value will most likely be needed.

Brake - Control Tab - Switch

Brake monitoring via an independent contact is required by code only for disc brakes.

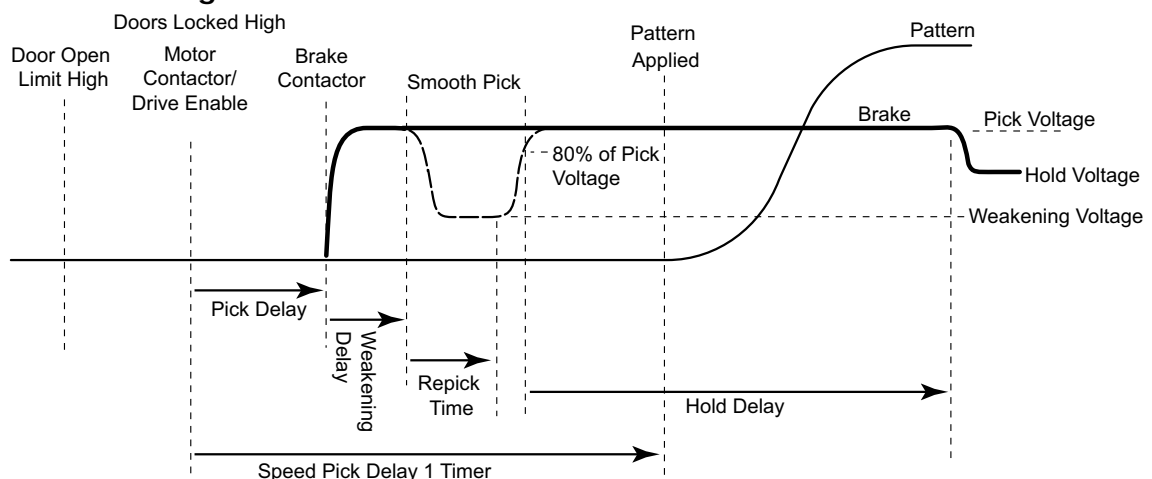
- **Brake is picked when SP2D or Brake Switch terminal is high:** Sets polarity of the brake contact input.
- **Brake is picked when SP2D or Brake Switch terminal is low:** Sets polarity of the brake contact input.
- **Monitor for brake pick fault:** Specifies brake pick fault monitoring via an independent contact. [Please refer to the Brake Pick Fault message description\(see page 6-16\).](#)
- **Monitor for brake drop fault:** Specifies brake drop switch fault monitoring. [Please refer to the Brake Drop Fault message description\(see page 6-15\).](#)

Brake - Control Tab - Timers

The Brake > Control tab - Timer section allows you to set the various delays associated with brake operation.

- **Pick delay:** The delay between when the drive is enabled for a run and when the brake voltage is set to Pick voltage. [Please refer to “Speed Pick Delay” on page 4-7.](#) [Please refer to “Empty Car Tests” on page 3-31.](#)
- **Hold delay:** Determines how long the brake voltage remains at Pick voltage before Hold voltage is applied. The timer starts after Repick time expires.
- **Weakening delay:** Determines how long the brake voltage remains at Pick voltage before Weakening voltage is applied. This timer starts after Pick delay expires. If there is no rollback, set Weakening delay = 0.00 sec.
- **Repick time:** Determines how long the brake voltage remains at Weakening voltage before Pick voltage is reapplied. This timer starts after Weakening delay expires. If there is no rollback, set Repick delay = 0.00. [Please refer to “Brake Parameter Adjustments” on page 4-20.](#)
- **Speed pick delay 1:** Determines the time between when the drive is enabled for a run and pattern application. Used to coordinate brake picking with the beginning of acceleration. Adjust this parameter for minimum rollback without moving through the brake. [Please refer to “Speed Pick Delay” on page 4-7](#)
- **Speed pick delay 2:** This delay is applied after the door locks are made up and Speed pick delay 1 expires. It has the potential of being applied only if a “While doors are closing with motor and partially picked brake” pre-start sequence is selected. Under this restricted condition, it would only be applied if the motor and brake contactor are picked before the door locks make up. If the door locks are made up or any other pre-start sequence is selected, only a Speed pick delay 1 would be applied.
- **Contactor drop delay:** Determines how long the motor and brake contactors remain picked after the Drive Enable signal is dropped.
- **Brake drop delay:** Used to allow the car to stop completely after a normal run before dropping the brake. The timer starts when the Direction signal is dropped (Stop Command). [Please refer to “Final Stop” on page 4-26.](#)
- **Voltage decay time:** Determines the amount of time over which the brake voltage will “decay” and gradually drop the brake. A longer Voltage Decay Time will lead to a more gradual brake drop. [Please refer to “Final Stop” on page 4-26.](#)

Figure 9.1 Brake Timing





Danger

Warning! Possibility of losing control of the car at the end of the run if Drop Delay and Voltage Decay time exceed Contactor Drop Delay!

Brake - Configuration Tab



Caution

The parameters on this tab are set automatically during brake calibration. Do not modify these parameters unless advised to do so by an MCE representative.

- **Voltage:** The voltage output to the brake coil at various percentages of maximum voltage, measured during calibration (**see Caution above**).
- **Output Timer:** The amount of OFF time during each cycle (delay before turning on the brake output) required to output the appropriate voltage to the brake coil at various percentages of maximum voltage (**see Caution above**).
- **Current Reference:** The voltage feedback that represents the brake current at various percentages of maximum voltage, measured during calibration (**see Caution above**).

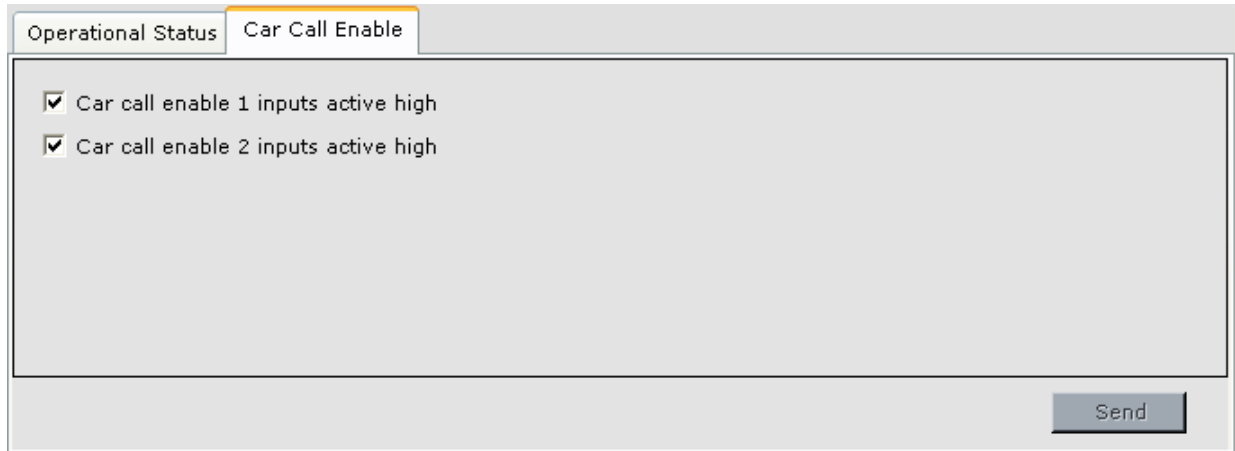
Operational Status		Brake			
Voltages		Timers		Configuration	
	Voltage Vdc	Output Timer ms	Current Reference		
At 100%	500.000	0.440	0.400		
At 90%	400.000	0.830	0.400		
At 80%	300.000	1.660	0.400		
At 70%	250.000	2.490	0.400		
At 60%	200.000	3.320	0.400		
At 50%	150.000	4.160	0.400		
At 40%	100.000	4.990	0.400		
At 30%	75.000	5.820	0.400		
At 20%	50.000	6.840	0.400		
At 10%	25.000	7.480	0.400		

Table 9.4 Typical Configuration Values for 300V AC Brake Supply

Typical Values for a 300VAC Brake Supply			
Percent of V max	Voltage VDC	Output Timer	Current Reference
At 100%	249.639V	0.100ms	0.243V
At 90%	225.484V	2.084ms	0.214V
At 80%	200.253V	2.852ms	0.194V
At 70%	174.083V	3.492ms	0.171V
At 60%	149.155V	4.608ms	0.149V
At 50%	125.508V	4.580ms	0.128V
At 40%	99.164V	5.156ms	0.105V
At 30%	73.632V	5.735ms	0.082V
At 20%	49.092V	6.308ms	0.069V
At 10%	25.041V	7.012ms	0.040V

Configuration - Car Call Enable

Car Call Enable inputs are used with card reader or key switch security devices. The inputs are programmed using the Controller > Configuration > I/O Boards tab. When Elevator Security is on, the appropriate car call enable input must be activated in order for a call to be registered to the corresponding secured floor. This screen allows you to specify the polarity (active high or active low) of the Car call enable 1 and 2 inputs. Other parameters relating to these inputs are programmed using iCue.



Operational Status Car Call Enable

- Car call enable 1 inputs active high
- Car call enable 2 inputs active high

Send

Configuration - Car Operation

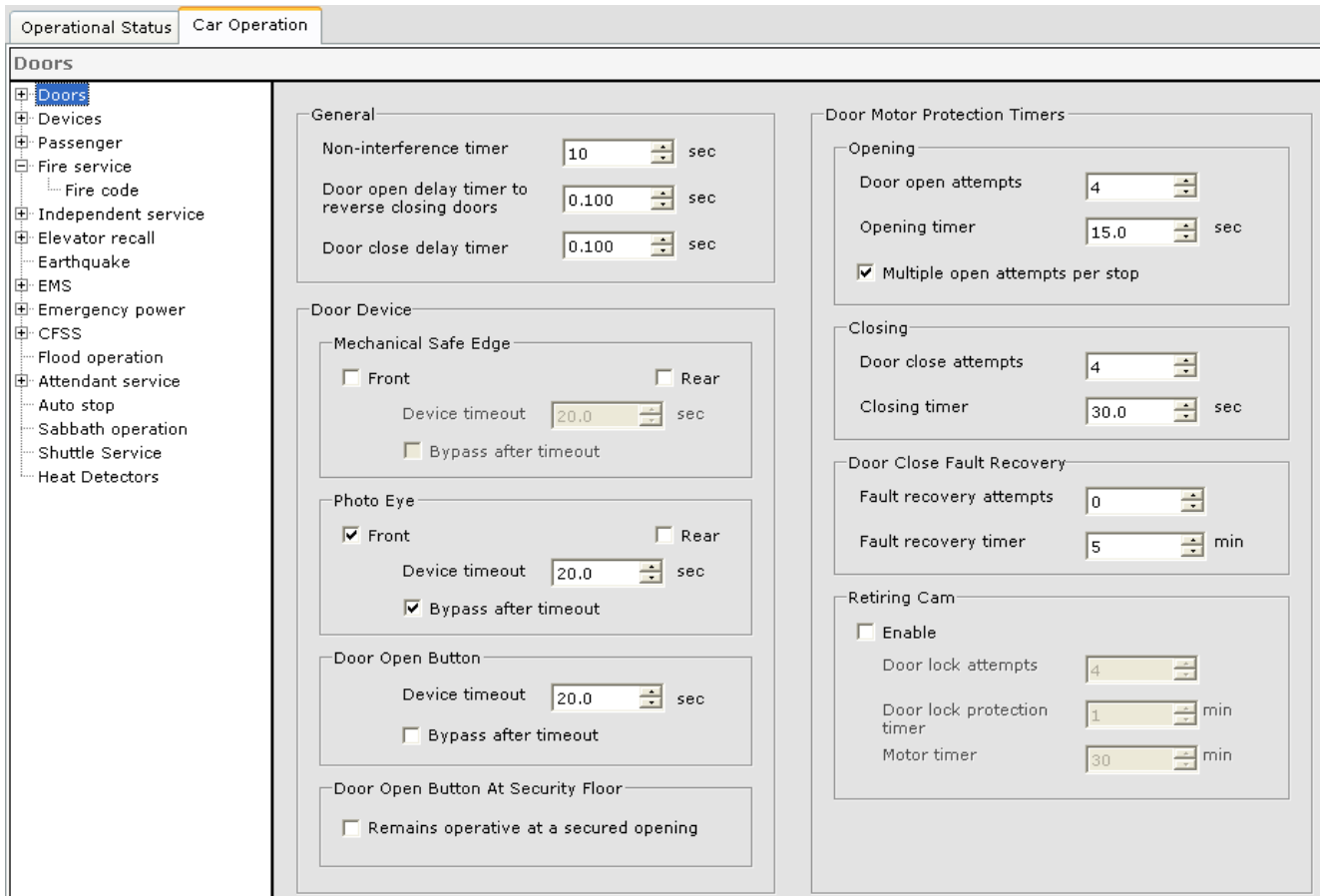
The Configuration > Car Operation tab is used to view and adjust car door and device behavior under different operating modes. If you are viewing this as a PDF file, click the page number link to jump to the description of the parameters on that tab. The car operation sub-tabs include:

Table 9.5 Configuration - Car Operation Sub-tabs

Sub-tab	Description	See
Doors	Door device bypass timers, door motor protection timers, and door closing delay parameters.	page 9-30
Devices	Arrival fixture, CE Electronics fixture and voice communicator parameters.	page 9-33
Passenger	Door opening and closing, photo eye, dwell timers, load weigher, car delayed timer, and call cancel parameters.	page 9-37
Fire Service	Applicable code Fire Service Recall and In-Car Fire-fighter's Service parameters.	page 9-44
Independent Service	Independent Service parameters.	page 9-59
Elevator Recall	Elevator recall switches configuration.	page 9-61
Earthquake	Applicable code and advanced EQ parameters. Counterweight device.	page 9-64
EMS	Emergency Medical Service operation parameters.	page 9-66
Emergency power	Emergency Power operating parameters.	page 9-70
CFSS	Commandeer for Special Service parameters.	page 9-73
Flood Operation	Determines car behavior during flood operation.	page 9-76
Attendant service	Attendant Service operation parameters.	page 9-78
Auto stop	Auto Stop operation parameters.	page 9-79
Sabbath operation	Sabbath operation parameters.	page 9-81
Shuttle Service	Shuttle service parameters.	page 9-84
Heat Detectors	Heat Detector operation parameters.	page 9-86

Car Operation - Doors tab

The Doors tab allows you to set bypass timers for elevator safe edge and photo eye devices, set door protection timers, enable simplex operation, latch open or close door power, and disable door contact monitoring.



General

- **Non-interference timer:** Determines the number of seconds a car with non-automatic door operation waits at a floor in response to a call before proceeding to answer other demands.
- **Door Open delay timer to reverse closing doors:** This timer is used to delay the door open command on closing doors.
- **Door close delay timer:** This timer is used to delay the door close command.

Door Device

- **Mechanical Safe Edge:** Check *Front* and/or *Rear* to indicate that the doors have a mechanical safe edge. If, after a period of time, an active safe edge input should be bypassed and the doors closed, enable bypass (check *Bypass after timeout*) and set the timer (*Device timeout*) to the desired time. This option works in conjunction with Nudging (see “Nudging” on page 9-37).

- **Photo Eye:** Check *Front* and/or *Rear* to indicate that the doors have a photo eye. If, after a period of time, an active photo eye input should be bypassed and the doors closed, enable bypass (check *Bypass after timeout*) and set the timer (*Device timeout*) to the desired time. This option works in conjunction with Nudging (see “Nudging” on page 9-37).
- **Door Open Button:** If, after a period of time, an active door open button input should be bypassed and the doors closed, enable bypass (check *Bypass after timeout*) and set the timer (*Device timeout*) to the desired time. This option works in conjunction with Nudging (see “Nudging” on page 9-37).
- **Door Open Button At Security Floor:**
 - **Remains operative at a secured opening:** When checked, the Door Open Button will remain operative for the side that has opened at a secured/locked floor (meaning that someone has access to that side via a car call or hall call). Otherwise the DOB will only be enabled as long as the doors are not fully closed.

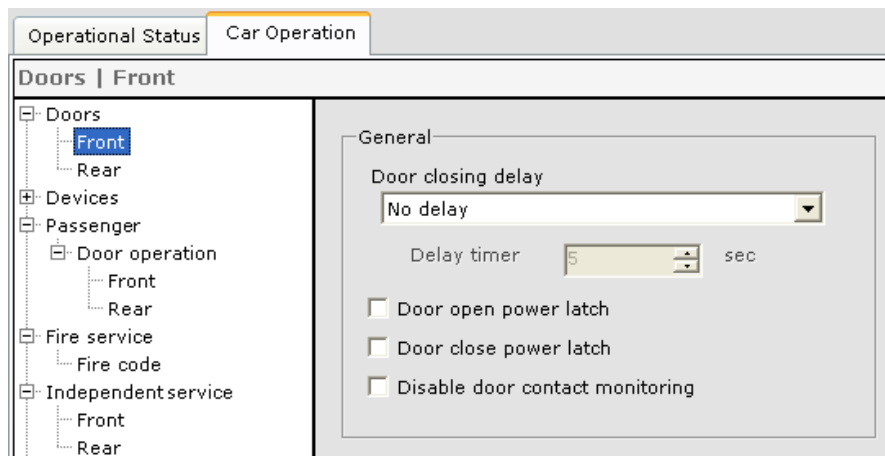
Door Motor Protection Timers

- **Opening:**
 - **Door open attempts:** Determines the number of opening cycles the door should attempt before a door open fault is declared.
 - **Opening timer:** This setting determines the amount of time, in seconds, that the elevator car should continue to attempt to open its doors if the initial open attempt is not successful. When this timer expires, the doors will close fully. The subsequent action of the elevator depends upon the setting of *Multiple open attempts per stop*.
 - **Multiple open attempts per stop:** If enabled, the elevator will stay at the floor and the doors will attempt to reopen the number of times determined by the Door Open Attempts setting. After the selected number of open attempts has been reached, a door open fault will be declared. If the Door Open button is pressed and held, the doors will attempt to open without any close attempts between cycles. The fault is cleared when the doors successfully open.
 - If Multiple Open Attempts Per Stop has not been enabled, the elevator will proceed to answer the next call or demand (once the doors have fully closed), unless there are additional attempts to open the door (hall call, car call, or open button activation). In either case (whether it has left the floor or remained because of additional open attempts), a door open fault will be declared if the door fails to successfully open for the set number of consecutive times.
- **Closing:**
 - **Door close attempts:** Determines the number of closing cycles the door should attempt before a door close fault is declared.
 - **Closing timer:** This setting determines the amount of time, in seconds, that the elevator car should continue to attempt to close its doors. When this timer expires, the doors will reopen fully, stand open for a short time, and then initiate another close attempt. This cycle will repeat until the doors reach the closed position or a pre-determined number of closing attempts has been made (Door close attempts). When this occurs, a door close fault will be declared. If the Door Close button is pressed and held, the doors will attempt to close without any open attempts between cycles. The fault is cleared when the doors successfully close.

- **Door Close Fault Recovery:**
 - Fault recovery attempts: (see Fault recovery timer).
 - Fault recovery timer: Timer starts when a Door Close Fault is detected. When the timer expires, the Door Close Fault is cleared to allow the doors to again attempt to close. If the doors still do not successfully close, another Door Close Fault is declared and the Fault recovery timer runs again. When the number of recovery attempts reaches the value of the Fault recovery attempts parameter, a Fault Recovery Failure is declared and the message is displayed. The car is shut down until a mode change is detected or the doors are successfully closed via constant pressure on the Door Close Button.
- **Retiring cam:**
 - Enable: Enables the retiring cam feature and motor protection functions.
 - Door lock attempts: The number of attempts made to lock the doors with the retiring cam before declaring a Retiring Cam Door Lock fault and re-opening the doors.
 - Door lock protection timer: The amount of time to attempt to lock the doors with the retiring cam before declaring a Retiring Cam Door Lock fault and re-opening the doors.
 - Motor timer: The amount of time to energize the retiring cam motor in an attempt to lock the doors before declaring a Retiring Cam Protection fault and re-opening the doors.

Doors - Front / Rear

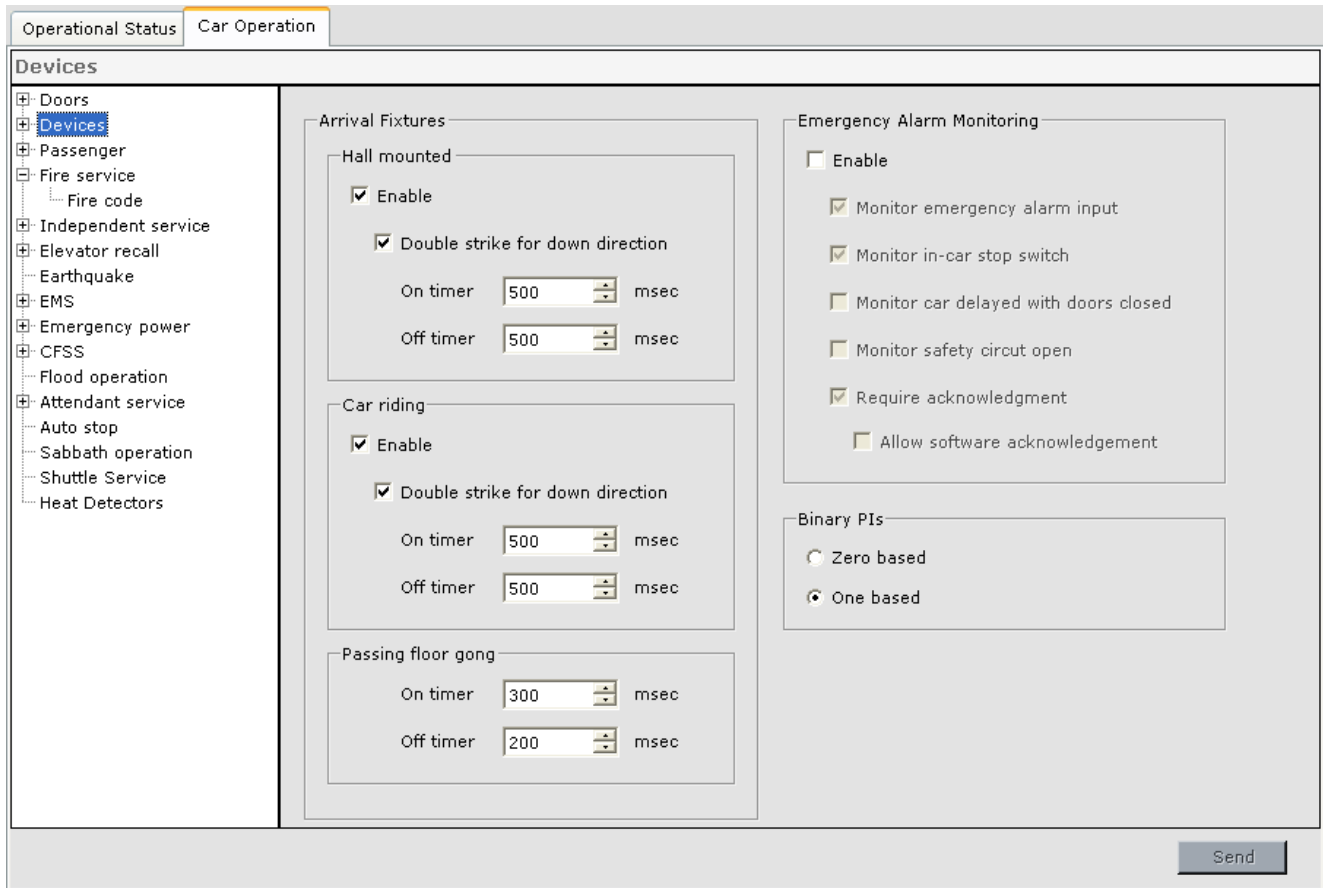
- **Door Closing Delay:** Determines under what conditions (No delay, Always delay, Delay only if closed with hall door close button, Sabbath delay) and how much door closing delay shall be applied. These parameters may be set independently for front and rear doors.



- **Door open power latch:** If enabled, the controller will sustain the door open command to the door operator, preventing the possibility of doors drifting closed when the command is dropped.
- **Door close power latch:** If enabled, the controller will sustain the door close command to the door operator, preventing the possibility of doors drifting open when the command is dropped.
- **Disable door contact monitoring:** If enabled, door contact monitoring is disabled.

Car Operation - Devices Tab

The Devices tab allows you to configure the car arrival “announcement” devices, emergency alarm monitoring and serial fixture parameters.



Arrival Fixtures

- **Hall Mounted:** Enable if hall-mounted arrival notification devices are used for this car.
 - **Double Strike on Down Direction:** Sound hall-mounted arrival fixtures twice when announcing down direction. If the fixtures themselves support double-striking, this feature should not be enabled.
 - Set the On Timer for the amount of time the gong output should be active. Set the Off Timer to establish the pause between first and second gongs.
- **Car Riding:** Enable if car-riding arrival notification devices are used for this car.
 - **Double Strike on Down Direction:** Sound car-riding arrival fixtures twice when announcing down direction arrival. If the fixtures themselves support double-striking, this feature should not be enabled.
 - Set the On Timer for the amount of time the gong output should be active. Set the Off Timer to establish the pause between first and second gongs.
- **Passing Floor Gong:** Set the On Timer for the amount of time the gong output should be active. Set the Off Timer to establish the minimum pause between gongs.

- **Emergency Alarm Monitoring:**
 - **Enable:** Enables emergency alarm monitoring.
 - **Monitor alarm button input:** By default, the alarm button alarm input is monitored with visible and audible indicators driven by the Alarm Light and Alarm Buzzer outputs.
 - **Monitor in-car stop switch:** By default, the in-car stop switch is monitored with visible and audible indicators driven by the Alarm Light and Alarm Buzzer outputs.
 - **Monitor car delayed with doors closed:** When enabled, if the car is delayed with doors closed an amount of time in excess of the Car delayed timer setting, the Alarm Light and Alarm Buzzer outputs will be activated.
 - **Monitor safety circuit open:** If enabled, any condition that causes a safety string switch, contact, or relay to open will activate the Alarm Light and Alarm Buzzer outputs.
 - **Require acknowledgement:** Requires that the emergency alarm be acknowledged in order to turn off the Alarm light and buzzer. Typically this is done via the Alarm Reset input.
 - **Allow software acknowledgement:** If enabled, emergency alarms may also be acknowledged via iMonitor.
 -
- **Binary PIs:**
 - **Zero based:** Specifies that the binary outputs to the position indicators shall be zero based.
 - **One based:** Specifies that the binary outputs to the position indicators shall be one based.

**Note**

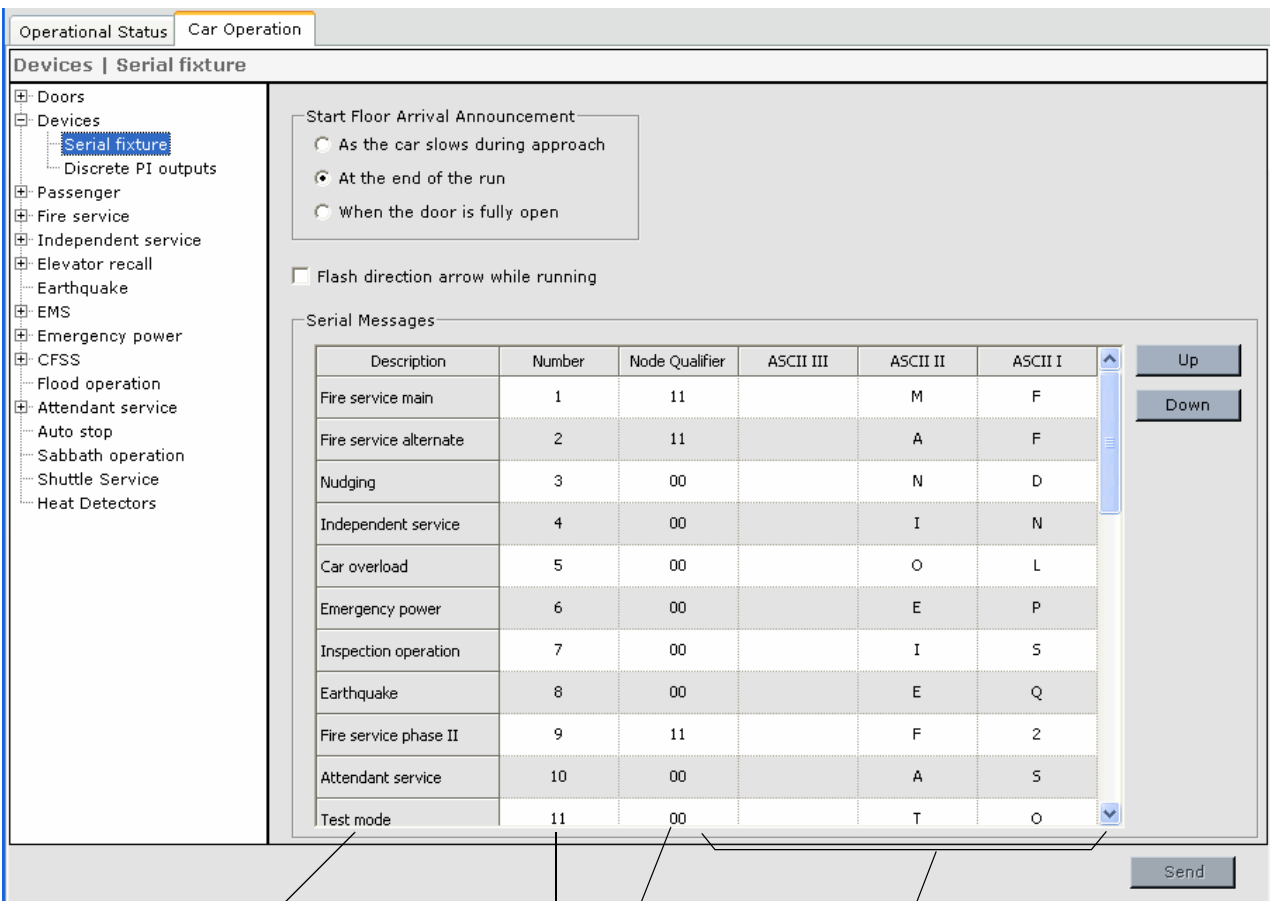
Alarm Light: Typically, the Alarm Light is placed where it will be visible to security personnel. The output remains latched until acknowledged by activation or the Alarm Reset input (typically a keyed switch).

**Note**

Alarm Buzzer: Typically, the Alarm Buzzer is placed where it will be audible to security personnel. The standard (in-car stop or alarm open) output is constant and causes a constant tone. The additional (delayed with doors closed or other open safety condition) output is pulsating and causes a pulsating tone. This output does not latch but remains active only so long as the monitored condition exists (switch, contact, or relay remains open).

Serial Fixture Tab on this tab.

If the installation uses CE Electronics serial fixtures, configure them

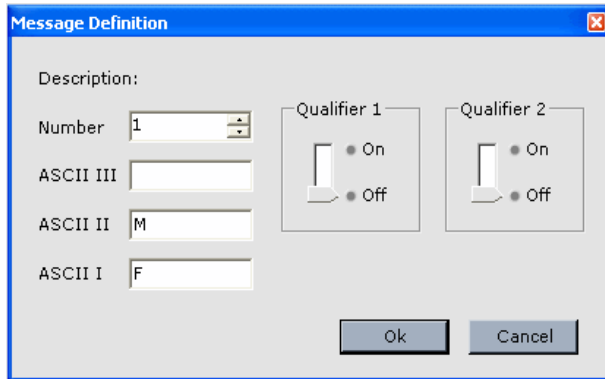


Message name Message number Node qualifier ASCII characters

- **Start Floor Arrival Announcement:** Select the time at which you want the voice arrival announcement to occur — As the car slows during approach, At the end of the run, or When the door is fully open.
- **Flash direction arrow while running:** Specifies that the direction arrow will flash while the car is running.
- **Serial Messages:** This control box allows you to configure announcements to be displayed or annunciated by the CE fixtures. Serial Messages are text or audible messages pre-programmed into the serial fixture (character display or “talking”) and triggered by the elevator controller. Configuring a message requires providing a number (matched to a fixture message number to display or announce the correct message), a node qualifier (determines which fixtures will display or annunciate the message), and if appropriate, three ASCII characters (letters A-Z, numbers 0-9: used by character displays to show an abbreviated message, e.g., FSA for Fire Service Alternate).
- **Up and Down Buttons:** Some fixtures display only one message at a time. If two or more messages are valid, the message highest on the list is displayed. To move a message up or down on the list, click the message to select it, click the up or down button to move the message, and click *Send* to send the change to the controller.

To configure a serial message description:

1. Double click a serial message *description* to open the message definition dialog.



2. Check the fixture manufacturers documentation to determine the message number to message correlation. Enter the number in the Number entry box.
3. If character displays (i.e., floor position indicators) should display the message condition abbreviation, enter the characters into the ASCII entry boxes from top to bottom as they should appear from left to right. For example, to display FSA, enter F in the ASCII III box, S in the ASCII II box, and A in the ASCII I box. Displays that display fewer than three characters will display the right most letters of the condition. (For FSA, a two character display would show “SA”; a one character display “A”).
4. Set the node qualifier. The node qualifier determines which fixtures will accept the message. Fixtures have switches that allow them to be designated 00, 01, 10, or 11 (two switches, on=1, off=0). Fixtures with a 00 address will display all messages. Refer to the following table to see which fixtures will display the node qualified messages.

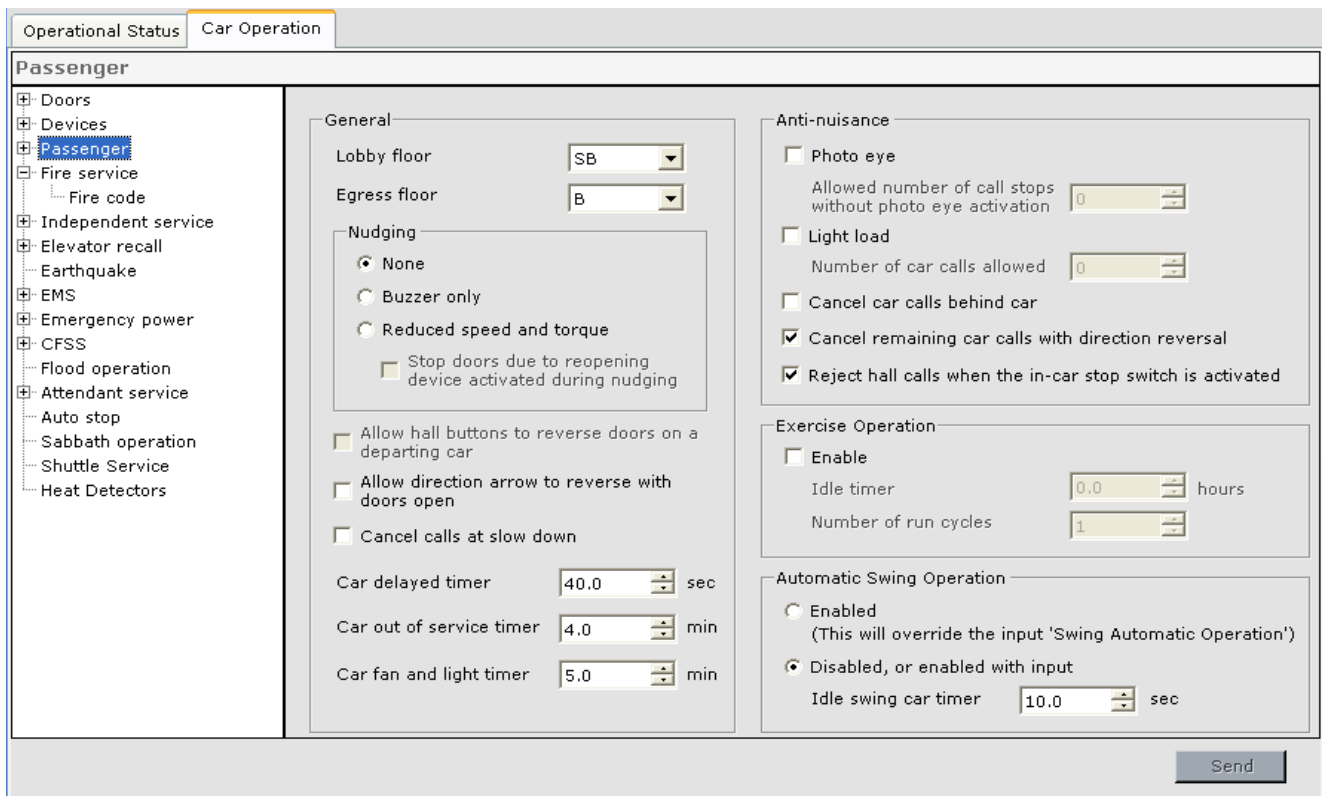
Table 9.6 Serial Fixture Message Display or Annunciation

Fixture Switch	Node Qualifier	Action
00	00	Accept
	01	Accept
	10	Accept
	11	Accept
01	00	Accept
	01	Accept
	10	Reject
	11	Reject
10	00	Accept
	01	Reject
	10	Accept
	11	Reject
11	00	Accept
	01	Reject
	10	Reject
	11	Accept

5. Click OK to set the message.
6. Message priority determines which message will be displayed first if more than one message is active at a time. Messages higher in the table have higher priority. To change a message priority, highlight the message name, then use the arrow buttons to move it up or down in the table.

Car Operation - Passenger Tab

The Passenger tab is used to configure car and door behavior on Passenger (Norm) operation.



General

- **Lobby floor:** This setting determines which floor will use the lobby dwell timer. If the car is part of a group, the group dispatcher settings for primary and alternate lobby floors supersede this selection.
- **Egress floor:** The *Egress Floor Gong* output will activate for 500 ms when the car arrives at this floor in response to a car or hall call. This output is used to activate an audible indicator to alert the visually impaired that the car has arrived at the main egress floor.

Nudging Nudging is intended to discourage passengers from holding the doors open for excessive lengths of time. These options work in conjunction with the Door Device settings (see [“Door Device” on page 9-30](#)). The nudging options are:

- **None:** Nudging is disabled.
- **Buzzer only:** When the reopening device bypass timer expires, only the buzzer will sound.
- **Reduced speed and torque:** An open door will attempt to close at reduced speed and torque if it is held open for an extended period of time. This time is determined by the reopening device bypass timer.
 - **Stop doors due to reopening device activated during nudging:** If enabled, activation of a safe edge during nudging will stop the doors from closing. Otherwise they will fully reopen.

To see how the Nudge and Buzzer outputs and Door operation after device timeout are affected by the various nudging and door device settings, see [Table 9.7 Nudging Operation Table](#).

Table 9.7 Nudging Operation Table

Nudging Option	Bypass Option	Safe Edge Option	Nudge Output	Buzzer Output	Door Operation After Device Timeout
None	No	-	Off	Off	Remain open
None	Yes	No	Off	Off	Remain open
None	Yes	Yes	Off	Off	Close at normal speed
Buzzer only	No	-	Off	On	Remain open
Buzzer only	Yes	No	Off	On	Remain open
Buzzer only	Yes	Yes	Off	On	Close at normal speed
Reduced speed and torque	No	-	Off	Off	Remain open
Reduced speed and torque	Yes	-	On	On	Close at reduced speed

- Allow hall call button to reverse doors on a departing car: (*Not implemented on this screen*) Please refer to the iCue > Group Configuration > Dispatching tab “Allow same floor hall calls to reverse doors on a departing car” parameter.
- Allow direction arrow to reverse with doors open: If the car is at a destination floor and the next demand is in the opposite direction of the last run, determines whether the direction arrow is allowed to reverse while the elevator doors are open. Enable if the direction arrow is allowed to reverse with the elevator doors open.
- Cancel calls at slow down: By default, when answering a call, the call is canceled when the car reaches door zone. This option specifies that calls are to be canceled when the car begins slow down when approaching the floor.
- Car delayed timer (seconds) - If a car is delayed in satisfying a demand an amount of time in excess of this timer setting, it will be taken out of hall call service. All calls remain registered. Hall calls are reassigned if the car is in a group.
- Car out of service timer (minutes) - This timer starts once the Car delayed timer (above) expires. If the Car delayed condition persists for this amount of time, the car is taken out of service and all calls are cancelled.
- Car fan and light timer (minutes): Set the number of minutes the car fan and light should remain on when the car is parked before automatically shutting off. The fan and light will become active again when the car responds to a demand.

Anti-Nuisance Anti-nuisance functions help the controller recognize and avoid nuisance operation, for example, a passenger intentionally interfering with elevator operations by unnecessarily selecting multiple stops, etc.

- Photo eye: All remaining car calls are canceled if the photo eye has not been activated and the number of car call stops exceeds the “Allowed number of car call stops without photo eye activation” parameter.
- Light load: All car calls are canceled if the number of registered calls exceeds the “Number of car calls allowed” parameter and the car weight (percentage of full load), as measured by the load weigher, is less than the “Light Load Threshold” parameter.
- Cancel car calls behind car: If enabled, car calls entered in the opposite direction to current or upcoming direction of travel are not allowed.
- Cancel remaining car calls with direction reversal: If enabled, when the car reverses direction of travel, any remaining calls in the previous direction are cancelled. For example, an up travelling car has car calls registered below it. Those calls will be cancelled when the car switches direction to down.

- Reject hall calls when the in-car stop switch is activated:
 - If checked, the car is taken out of hall call service and hall calls are re-assigned when the in-car stop switch is pulled. If no other car is available, calls remain registered but unassigned. If the stop switch is still pulled after ten seconds, the car is taken out of service and any unassigned hall calls are canceled if this is the only car.
 - If not checked, when the in-car stop switch is pulled the car remains in service and assigned hall calls remain assigned to the car. If the stop switch is still pulled after ten seconds, the car is taken out of service and all assigned hall calls are re-assigned or canceled if this is the only car.

Exercise Operation This option is used to cause the elevator to perform a number of full hatch runs after being idle (on normal passenger service) for a number of hours. Once exercised, the car returns to normal operation.

- Enable: Check to enable exercise operation.
 - Idle timer: The exercise operation will be performed when the car has been idle (on normal passenger operation) for more than the set number of hours.
 - Number of run cycles: Sets the number of run cycles to be performed. One cycle is a full hatch run up and down.

Automatic Swing Operation Swing operation removes a car from some aspects of central dispatcher or Local/Dispatcher control. During Swing operation the car responds to hall call demand from a dedicated set of hall calls (a Swing riser).

- Enable: If enabled, the car will automatically enter Swing operation when a hall call is received from the Swing riser. Automatic Swing operation assumes an “always active” Swing riser. This option will override the “Swing Automatic Operation” input.
- Disabled, or enabled with input: This option allows Automatic Swing operation to be enabled by activation of the “Swing Automatic Operation” input. The car will automatically enter Swing operation when a hall call is received from the Swing riser.
 - Idle swing car timer: Automatic Swing operation is monitored. An idle Swing car will return to normal service if no Swing riser inputs are activated for the period of time set by this control. Idle is defined as a car with no assigned calls, parking demand, or door dwell times.

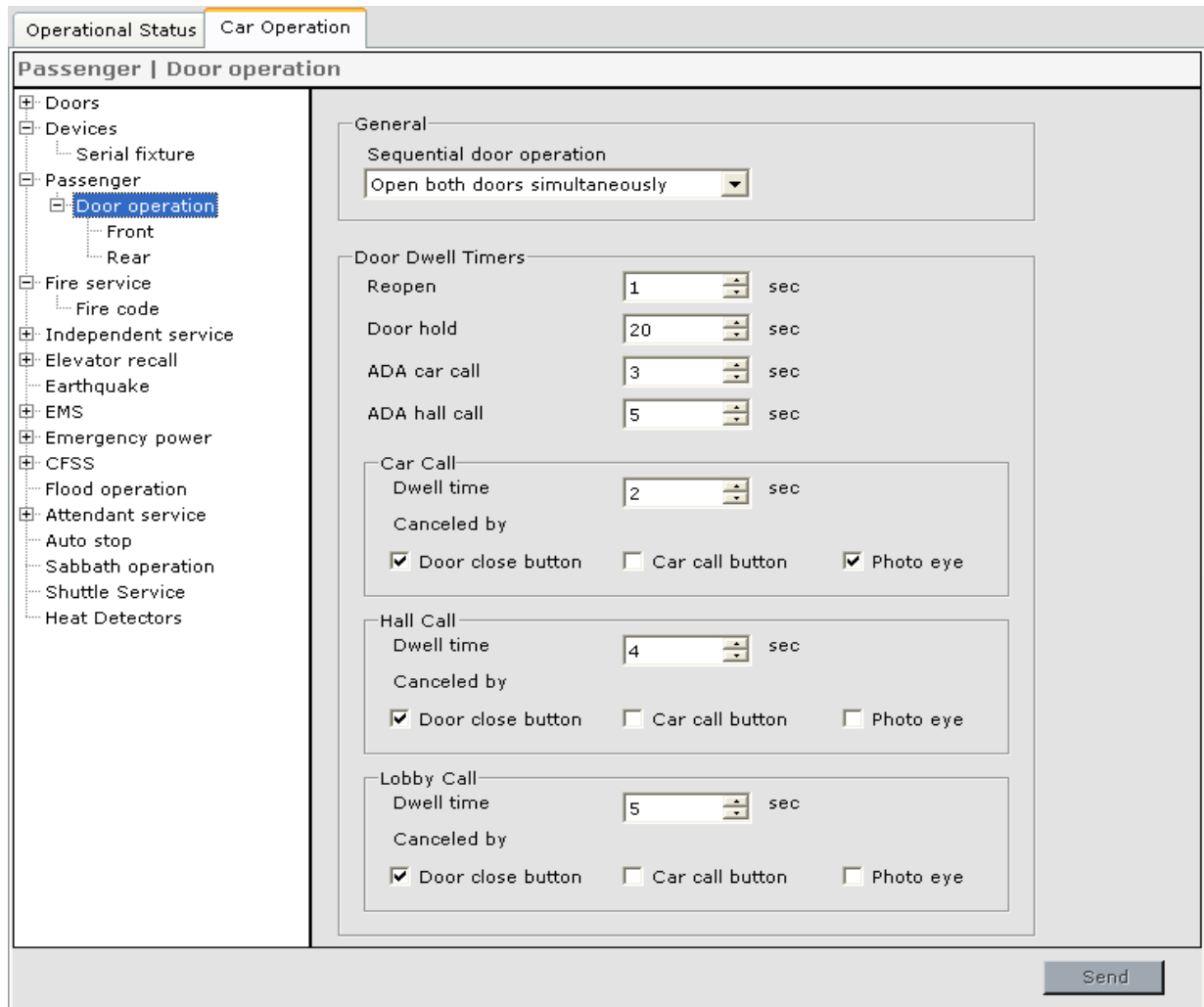
While Swing operation is active:

- The car does not use the dispatching and security parameter settings from the central or local dispatcher. It uses parameter settings stored on its own iBox. With Swing operation enabled either by enabling Automatic Swing Operation or by assigning the Swing Operation Switch input to an I/O board terminal, these parameters must be programmed using iView connected to the Swing car’s iBox.
- The Swing car does not service group hall calls. Any existing group hall calls for the car are canceled or reassigned. Hall call eligibility for the swing car must be programmed using the Swing car’s System View > System Configuration > Hall Call Eligibility tab.
- The car parks at the floor assigned on the Swing car’s System Configuration > Parking tab.
- Existing car calls are not affected unless an alternate car call eligibility set is assigned by activation of a constant closure switch, in which case car calls are disposed of according to settings for that eligibility set. Up to eight alternate car call eligibility sets may be defined. [Please refer to “General - Car Call Eligibility Tab” on page 9-97.](#)

- The Swing car uses normal passenger settings pertaining to door operation, door dwell timers, etc.
- The Swing car uses elevator security settings that are stored on its own iBox. The security parameters must be programmed using the Swing car's System View > Configuration > Security tab.
- Emergency dispatching caused by loss of communication between the car and the central or Local/Dispatcher+ is disabled.

Passenger - Door operation tab

The Configure > Car Operation > Passenger > Door operation tab determines door behavior for both front and rear doors while on Passenger (Norm) operation.



The screenshot shows the 'Passenger | Door operation' configuration window. On the left is a tree view with the following items: Doors, Devices (Serial fixture), Passenger (Door operation, Front, Rear), Fire service (Fire code), Independent service, Elevator recall, Earthquake, EMS, Emergency power, CFSS, Flood operation, Attendant service (Auto stop, Sabbath operation, Shuttle Service, Heat Detectors). The 'Door operation' sub-tab is selected. The main area contains the following settings:

- General:** Sequential door operation: Open both doors simultaneously (dropdown).
- Door Dwell Timers:** Reopen: 1 sec; Door hold: 20 sec; ADA car call: 3 sec; ADA hall call: 5 sec.
- Car Call:** Dwell time: 2 sec; Canceled by: Door close button, Car call button, Photo eye.
- Hall Call:** Dwell time: 4 sec; Canceled by: Door close button, Car call button, Photo eye.
- Lobby Call:** Dwell time: 5 sec; Canceled by: Door close button, Car call button, Photo eye.

A 'Send' button is located at the bottom right of the configuration area.

General

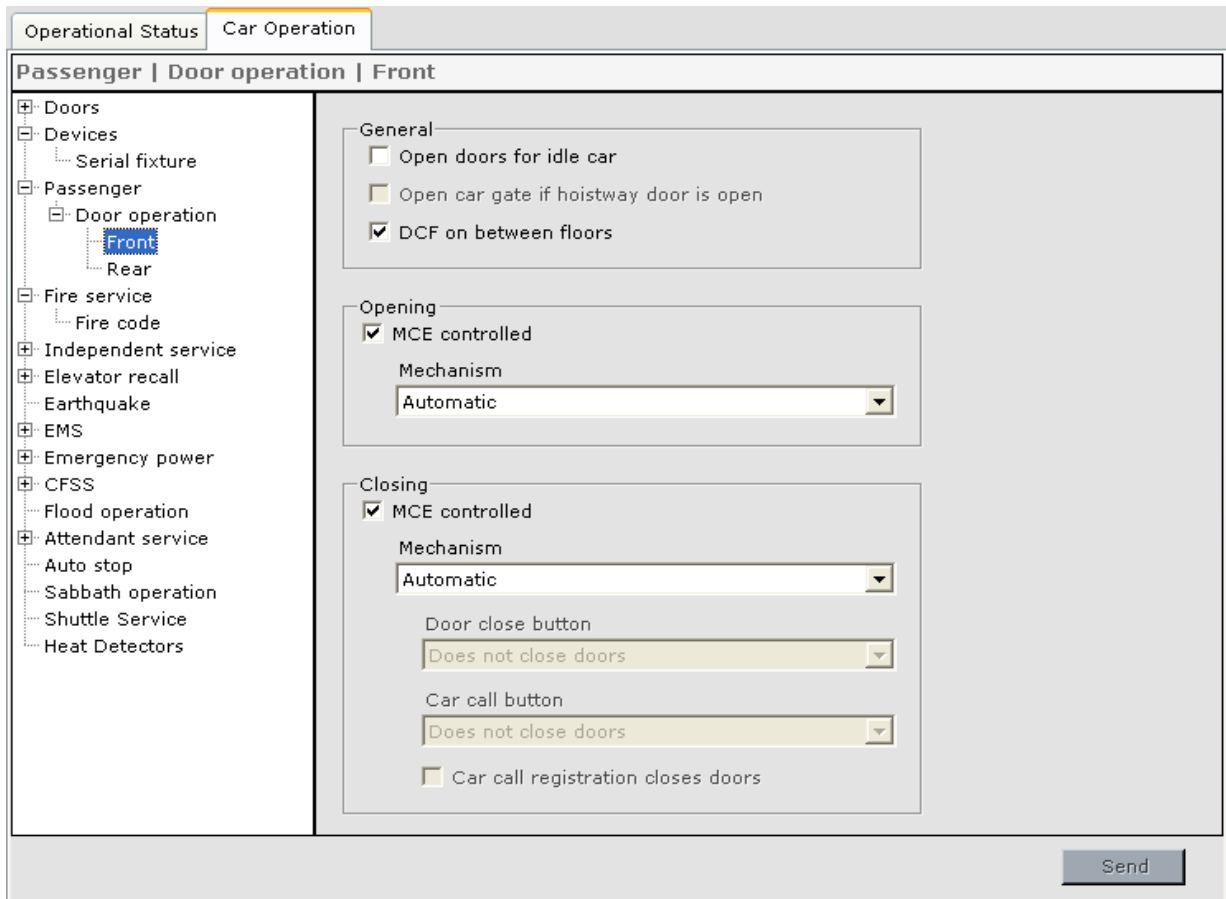
- Sequential Door Operation
 - Open both doors simultaneously: If enabled, both doors are allowed to open at the same time.
 - Open front doors first: If enabled, the front doors will be opened first.
 - Open rear doors first: If enabled, the rear doors will be opened first.

Door Dwell Timers These timers set the door dwell times.

- **Reopen:** The amount of time that the doors are to remain open (dwell) when a door reopening device or open button has been activated.
- **Door hold:** The amount of time that the doors are to remain open when reopened by the activation of the Door Hold button.
- **ADA car call:** The minimum amount of time that the doors are to remain open after arriving at a floor selected by a car call per ADA requirements. Door dwell is not shortened by activation of a button or door reopening device (call or door close button, etc.). Timer starts when doors are fully open.
- **ADA hall call:** The minimum notification time from activation of the hall gong to when the door is about to close as required by the Americans with Disabilities Act. This dwell is not shortened by activation of a car call or door close button.
- **Car Call**
 - **Dwell time:** The amount of time that the doors are to remain open when responding to a car call. Any of the following may be specified to cancel car call dwell time:
 - **Door close button:** Pressing the door close button will cancel car call dwell time.
 - **Car call button:** Pressing a car call button will cancel car call dwell time.
 - **Photo eye:** Activation of the photo eye detector will cancel car call dwell time.
- **Hall Call**
 - **Dwell time:** The amount of time that the doors are to remain open when responding to a hall call. Any of the following may be specified to cancel hall call dwell time.
 - **Door close button:** Pressing the door close button will cancel hall call dwell time.
 - **Car call button:** Pressing a car call button will cancel hall call dwell time.
 - **Photo eye:** Activation of the photo eye detector will cancel hall call dwell time.
- **Lobby Call**
 - **Dwell time:** The amount of time that the doors are to remain open when responding to a call at the lobby floor. Any of the following may be specified to cancel lobby call dwell time:
 - **Door close button:** Pressing the door close button will cancel lobby call dwell time.
 - **Car call button:** Pressing a car call button will cancel lobby call dwell time.
 - **Photo eye:** Activation of the photo eye detector will cancel lobby call dwell time.

Passenger - Door operation - Front / Rear tabs

The Configure > Car Operation > Passenger > Door operation > Front and Rear tabs determine door behavior for front or rear doors while on Passenger (Norm) operation.



The screenshot shows the 'Car Operation' tab selected, with the 'Passenger | Door operation | Front' sub-tab active. The left sidebar contains a tree view with 'Door operation' expanded to show 'Front' and 'Rear'. The main configuration area is divided into three sections:

- General:**
 - Open doors for idle car
 - Open car gate if hoistway door is open
 - DCF on between floors
- Opening:**
 - MCE controlled
 - Mechanism: Automatic
- Closing:**
 - MCE controlled
 - Mechanism: Automatic
 - Door close button: Does not close doors
 - Car call button: Does not close doors
 - Car call registration closes doors

A 'Send' button is located at the bottom right of the configuration area.

General •

- **Open doors for idle car:** The car will park with doors open. If the parking option is not set, the car will remain at the last floor answered with doors open.
- **Open car gate if hoistway door open:** The car gate will open if the hoistway door is open.
- **DCF on between floors:** Specifies that the door close function shall be on when the car is not at a floor in non-inspection modes.

Opening When “MCE Controlled” is checked, the following parameters determine what action will cause the doors to open when the car arrives at a floor.

Mechanism:

- **Automatic:** With the presence of door open intent, doors shall open automatically upon arrival at the floor. When the car is sitting idle, the doors will open and remain open.
- **Momentary pressure on door open button:** Doors shall not open automatically upon arrival at a floor. Momentary activation of the door open button initiates door opening.

Closing When “MCE Controlled” is checked, the following parameters determine what action will cause the doors to close.

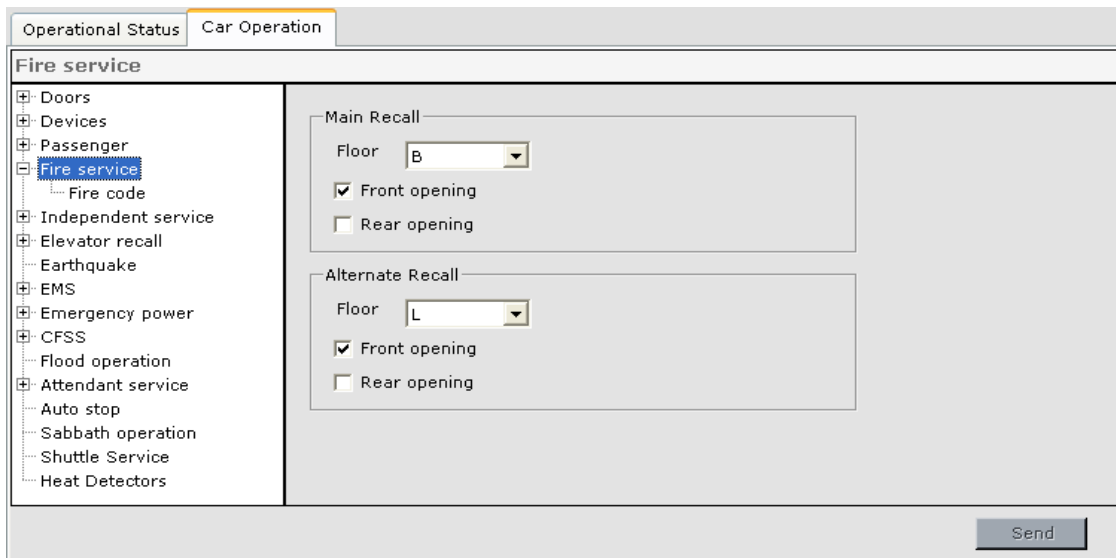
Mechanism:

- **Automatic:** With the absence of door open intent, the doors shall close automatically upon dwell time expiration.
- **Passenger initiated:** Doors shall not close automatically. The passenger initiated action selected below shall be required to cause the door to close.
 - **Door close button:**
 - **Does not close doors:** Doors shall not respond to door close button.
 - **Constant pressure:** Doors shall close with constant pressure on door close button. If the door close button is released before the doors are fully closed, the doors shall reopen and stand open.
 - **Momentary pressure:** Doors shall close with momentary pressure on door close button. Operational door reopening devices shall initiate door reopening, and once fully open the doors shall stand open until the door close button is again activated.
 - **Momentary pressure if a car call is registered:** Doors shall close with momentary pressure on door close button if a car call is registered. Operational door reopening devices shall initiate door reopening, and once fully open the doors shall stand open until the door close button is again activated.
 - **Car Call Button:**
 - **Does not close doors:** Doors shall not close in response to car call button.
 - **Constant pressure:** Doors will close with constant pressure on car call button. Operational door reopening devices shall initiate door reopening, and once fully open the doors shall stand open until the door close button is again activated.
 - **Momentary pressure:** Doors shall close with momentary pressure on car call button. Operational door reopening devices shall initiate door reopening, and once fully open the doors shall stand open until the door close button is again activated.
- **Car call registration closes doors:** Doors will close if a car call is registered.

Car Operation - Fire Service Tab

Settings on this tab determine car behavior during Fire Service operation. Fire Service operation typically proceeds in two stages. (Some codes allow the second stage to be initiated at any time by switch actuation.) The first stage, Recall, begins when a fire alarm, smoke detector, or fire recall switch is activated. During Recall, the elevator moves to a pre-determined floor to make itself available to emergency personnel. Based on the location of the initiating device(s), smoke detector, sensors, or recall switch, the car recalls to either the Main or Alternate recall floor. During recall, car speed and performance may be controlled by Standard Pattern or by Alternate 1 Pattern parameters (Configuration > Pattern tab). Car behavior during recall is determined by the Fire Code selected and by any user modifications to the selected Fire Code made using tabs accessed through the Configuration > Car Operation > Fire Service > Fire code tab.

Once cars arrive at the recall floor, they are taken out of service and will not respond to hall calls or car calls until the In Car Firefighter switch is activated. In this second stage of Fire Service, the car behaves as determined by the Fire Code selected and by any user modifications to the selected Fire Code made using tabs accessed through the Configuration > Car Operation > Fire Service > Fire code tab. During Fire Phase 2, car speed and performance may be controlled by Standard Pattern or by Alternate 2 Pattern parameters (Configuration > Pattern tab).



The screenshot shows the 'Car Operation' tab in the iView software. The 'Fire service' sub-tab is selected, and the 'Fire code' option is highlighted in the left-hand tree view. The main panel displays settings for 'Main Recall' and 'Alternate Recall'. For 'Main Recall', the 'Floor' is set to 'B', 'Front opening' is checked, and 'Rear opening' is unchecked. For 'Alternate Recall', the 'Floor' is set to 'L', 'Front opening' is checked, and 'Rear opening' is unchecked. A 'Send' button is located at the bottom right of the panel.

Main Recall Settings for Main fire recall.

- **Floor:** Specifies the Main Recall floor for Fire Recall operation.
- **Front Opening:** Specifies that the front doors shall open when the car completes Fire Recall Operation to the Main Recall floor.
- **Rear Opening:** Specifies that the rear doors shall open when the car completes Fire Recall Operation to the Main Recall floor.

Alternate Recall Settings for alternate fire recall.

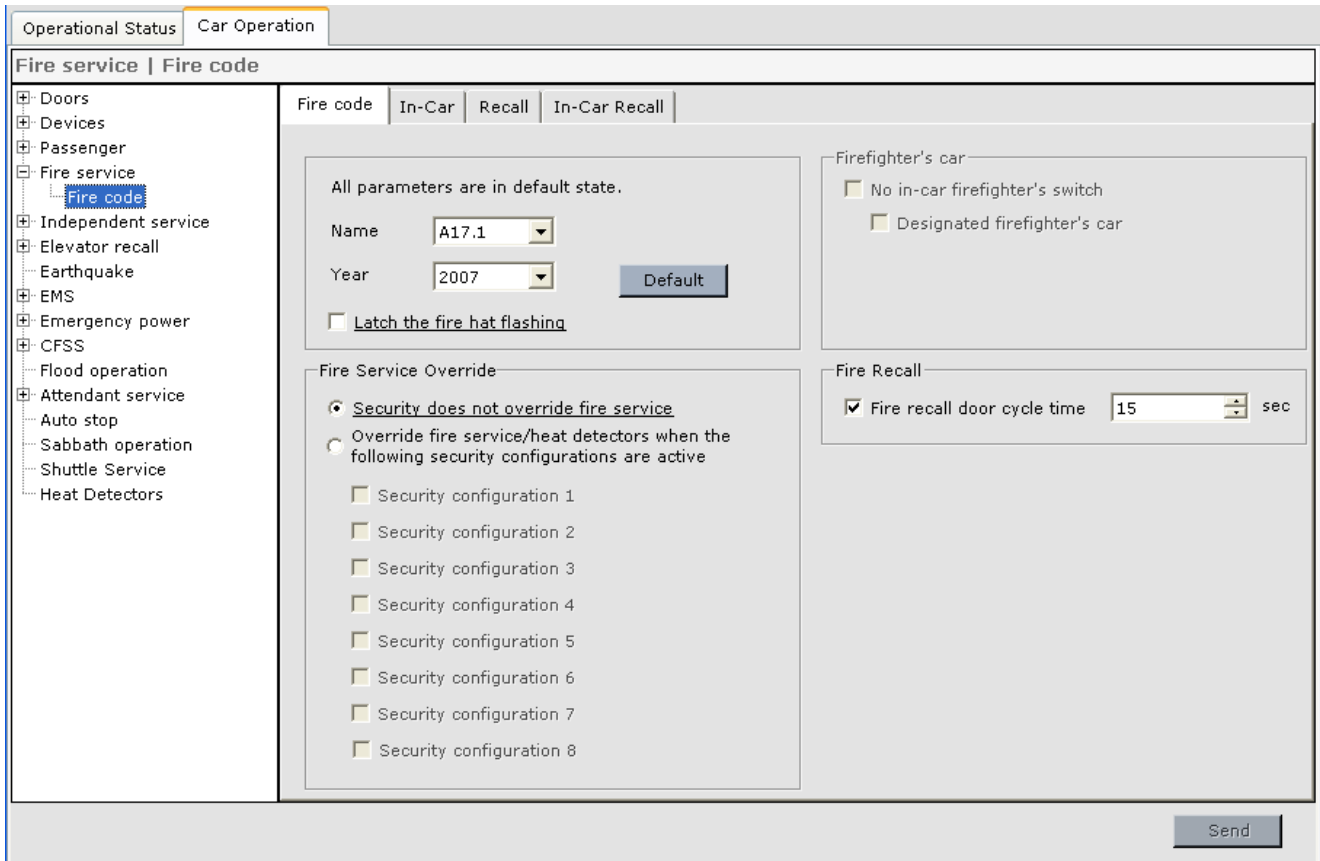
- **Floor:** Specifies the Alternate Recall floor for Fire Recall operation.
- **Front Opening:** Specifies that the front doors shall open when the car completes Fire Recall Operation to the Alternate Recall floor.
- **Rear Opening:** Specifies that the rear doors shall open when the car completes Fire Recall Operation to the Alternate Recall floor.

Fire Recall Settings for fire recall.

- **Fire recall door cycle time:** Sets the door cycle time for the Fire Recall Door Cycle option. When the car reaches the recall floor and doors are opened, the doors will then close after the Fire Recall Door Cycle time expires (used for pressurised hoistway).

Fire Service - Fire Code

Displays the currently selected Fire Code and allows a different Fire Code to be selected.



- **All parameters are in default state:** Indicates that all of the fire service parameters are set as specified by the selected code. If this is not the case, **“One or more parameters has been changed.”** is displayed.
- **Name:** Select the appropriate code from the drop down list.
- **Year:** Select the appropriate version (year) of the code.
- **Default** button: Sets the fire service parameters to the values specified by the selected code, e.g. A17.1 - 2000.
- **Latch the fire hat flashing:** Flashing the fire hat is required by certain jurisdictions whenever the hoistway or machine room smoke sensors are tripped. When these sensors are reset, the fire hat continues to flash if this option is set. Otherwise the fire hat will remain illuminated until fire service is deactivated.

Fire Service Override

- **Security does not override fire service:** This is the default state.
- **Override fire service/heat detectors when the following security configurations are active:** This option is intended only for an installation where security is of prime importance and where fire service/heat detectors operation would compromise that security. If this option is selected, fire service/heat detectors operation will not be allowed if Master security is active and one of the checked Security Configurations is active (System > Configuration > Security > General > Status). The active Security Configuration must have at least one floor secured or locked, regardless of the status of car call enable or car call enable override inputs. If a fire sensor/heat sensor or switch is activated while Master security is active, and then Master security is deactivated, fire service/heat detectors operation will be allowed. However, if fire service/heat detectors operation is already in progress and Master security is then activated, fire service/heat detectors operation will continue.
 - **Security configuration 1 (through 8):** Check the Security configuration(s) which, when active, will override fire service as described above.



Caution

Changing Fire Code parameter settings may cause you to be out of compliance with the selected code and may require a variance. Parameter settings that are in compliance with the selected code are shown with an underline. **If a setting is changed to one that does not comply with the selected code, it will appear in RED.**

Firefighter's car

- **No in-car firefighter's switch:** Check if the car does not have an in-car firefighter's switch (Required for British Fire Code EN 81-72).
 - **Designated firefighter's car:** Check if the car does not have an in-car firefighter's switch, but is a designated firefighter's car. Upon completion of Fire Phase I it will then automatically go to Fire Phase II.

Fire Recall

- **Fire recall door cycle time:** Sets the door cycle time for the Fire Recall Door Cycle option. When the car reaches the recall floor and doors are opened, the doors will then close after the Fire Recall Door Cycle time expires (used for pressurised hoistway).

Fire Code - Recall - General Tab

This tab allows you to set various fire code recall parameters.

- **Latch primary fire recall switch:**
 - **Never:** The recall condition will clear automatically when the initiating condition clears.
 - **Fire device OFF:** In order to clear the recall condition, the primary fire recall switch must be off.
 - **Primary bypass:** In order to clear the recall condition, the primary fire recall switch must be turned to the BYPASS position.
 - **Bypass and recall completed:** In order to clear the recall condition, the car must be at the fire floor with doors open and the primary fire recall switch must be turned to the BYPASS position.
 - **Recall completed all cars:** In order to clear the recall condition, the fire recall must be completed for all elevators in the group.
 - **Primary bypass then OFF:** In order to clear the recall condition, the primary fire switch must be turned to the BYPASS position and then back to off.

- Latch secondary fire recall switch:
 - Never: The recall condition will clear automatically when the initiating condition clears.
 - Fire device OFF: In order to clear the recall condition, the secondary fire recall switch must be off.
 - Primary bypass: In order to clear the recall condition, the primary fire recall switch must be turned to the BYPASS position.
 - Bypass and recall completed: In order to clear the recall condition, the car must be at the fire floor with doors open and the primary fire recall switch must be turned to the BYPASS position.
 - Recall completed all cars: In order to clear the recall condition, the fire recall must be completed for all elevators in the group.
 - Primary bypass then OFF: In order to clear the recall condition, the primary fire recall switch must be turned to the BYPASS position and then back to off.
- Latch first smoke detector zone:
 - Never: The recall condition will clear automatically when the initiating condition clears. When this option is set, the main floor smoke sensor will override the upper floor smoke sensors.
 - Fire device OFF: In order to clear the recall condition, the secondary fire recall switch must be off.
 - Primary bypass: In order to clear the recall condition, the primary fire recall switch must be turned to the BYPASS position.
 - Bypass and recall completed: In order to clear the recall condition, the car must be at the fire floor with doors open and the primary fire recall switch must be turned to the BYPASS position.
 - Recall completed all cars: In order to clear the recall condition, the fire recall must be completed for all elevators in the group.
 - Primary bypass then OFF: In order to clear the recall condition, the primary fire recall switch must be turned to the BYPASS position and then back to off.
- Fire Phase 1 nudging:
 - No nudging: During Fire Phase I, nudging will be inhibited.
 - Nudge if no reopen devices: During Fire Phase I, the doors will nudge close if there are no operative reopening devices.
- Disable DOB and nudge during Fire Phase I:
 - Not at all: The Door Open button will remain active.
 - Immediately: The Door Open button will immediately become inactive when Fire Phase I is initiated and the doors will nudge close if the Door Open Button is pressed as the doors are closing.
 - After delay: The Door Open Button will become inactive after the set delay when Fire Phase I has been initiated and the doors will nudge close if the Door Open Button is pressed as the doors are closing.

- Fire bypasses independent service:
 - No bypass: Fire recall will not bypass Independent Service.
 - Bypass immediately: Fire recall will immediately bypass Independent Service.
 - Bypass if running or after delay: Fire recall will bypass Independent Service after the delay set here expires or immediately if the car is running.
- Fire bypasses attendant service:
 - No bypass: Fire recall will not bypass Attendant Service.
 - Bypass immediately: Fire recall will immediately bypass Attendant Service.
 - Bypass if running or after delay: Fire recall will bypass Attendant Service after the delay set here expires or immediately if the car is running.
- Fire Switch Settings:
 - Require primary and secondary switch activation to override alternate floor recall: Enable if both primary and secondary fire switches must be active to override alternate floor recall.
 - Primary fire recall switch overrides alternate fire recall: Enable if primary fire recall switch will override alternate fire recall.
 - Secondary fire recall switch overrides alternate fire recall: Enable if secondary fire recall switch will override alternate fire recall.
 - Bypass position of primary recall switch bypasses sensors: Primary recall switch bypass position will bypass smoke sensors.
 - Primary fire switch recall resets alternate fire recall: Once the Phase I switch is used to recall the car to the main recall floor, the main recall floor becomes the recall level for the remainder of fire service operation regardless of the subsequent position of the fire switch or the status of the main floor fire sensor (complies with A17.1a-2005 or later code).
- Main Floor Sensor Options:
 - Primary switch on to reset alternate recall: Recall to the alternate fire floor can only be reset by putting the primary recall switch in the ON position (with this option enabled).
 - Alternate recall bypasses main recall: When a main floor recall is in process and an alternate floor recall is initiated, the main recall will be bypassed and the alternate recall will proceed (with this option enabled).
- Miscellaneous:
 - Fire 1 bypasses stop switch: Fire 1 will bypass the stop switch.
 - Fire 1 disables safety edge: Fire 1 will disable the door safety edge.
 - Disable door contact monitoring during fire recall: Door contact monitoring shall be disabled during fire recall.
 - Attendant operated fire warning buzzer: The fire warning buzzer will only be activated when the car is being operated by an attendant (required for British Fire Code EN 81-72).

Fire Code - Recall - Front / Rear Door Tabs

Determine how the doors shall open and close during Fire Recall operation.



Recall Not Completed - Recall Completed Determine how the doors shall open and close before recall has been completed and after recall has been completed. The parameters and descriptions are the same for both Recall Not Completed and Recall Completed and for both Front and Rear tabs.

Opening When “MCE Controlled” is checked, the following parameters determine what action will cause the doors to open when the car arrives at a floor.

Mechanism:

- **Automatic:** With the presence of door open intent, doors shall open automatically upon arrival at the floor. When the car is sitting idle, the doors will open and remain open.
- **Constant pressure on door open button:** Doors shall not open automatically upon arrival at a floor. Constant pressure activation of the door open button is required to open the doors. If the door open button is released before the doors are fully open, the doors shall re-close.
- **Momentary pressure on door open button:** Doors shall not open automatically upon arrival at a floor. Momentary activation of the door open button shall initiate opening the doors.

Closing When “MCE Controlled” is checked, the following parameters determine what action will cause the doors to close.

Mechanism:

- Automatic: With the absence of door open intent, the doors shall close automatically upon fire service activation.
- Passenger initiated: Doors shall not close automatically. The passenger initiated action selected below shall be required to cause the door to close.
 - Door close button:
 - Does not close doors: Doors shall not respond to door close button.
 - Constant pressure: Doors shall close with constant pressure on door close button. If the door close button is released before the doors are fully closed, the doors shall reopen and stand open.
 - Momentary pressure: Doors shall close with momentary pressure on door close button. Operational door reopening devices shall initiate door reopening, and once fully open the doors shall stand open until the door close button is again activated.
 - Momentary pressure if a car call is registered: Doors shall close with momentary pressure on door close button if a car call is registered. Operational door reopening devices shall initiate door reopening, and once fully open the doors shall stand open until the door close button is again activated. *(Not applicable to Fire Service Recall operation)*
 - Car Call Button:
 - Does not close doors: Doors shall not close in response to car call button.
 - Constant pressure: Doors will close with constant pressure on car call button. Operational door reopening devices shall initiate door reopening, and once fully open the doors shall stand open until the door close button is again activated.
 - Momentary pressure: Doors shall close with momentary pressure on car call button. Operational door reopening devices shall initiate door reopening, and once fully open the doors shall stand open until the door close button is again activated.

Fire Code - In-Car - General Tab

This tab allows you to set In-Car Firefighter parameters.

Fire code		In-Car	Recall	In-Car Recall
General		Front	Rear	
Fire Phase II recall condition		Doors open or closed		
Fire Phase II hold condition		Doors open hold		
Put car on Fire Phase II when		Recall completes		
Take car off Fire Phase II when		Recall completes		
Put car on Fire Phase II during Fire Phase II recall when		Doors are not closed		
Put car on Phase II hold when		Never		
During Fire Phase II Hold		<input checked="" type="checkbox"/> Keep doors open and disable door close button <input checked="" type="checkbox"/> Cancel car calls		
Conditions for stopping / disabling doors		<input checked="" type="checkbox"/> Emergency stop switch stops doors <input type="checkbox"/> Emergency stop switch disables door opening <input type="checkbox"/> Emergency stop switch disables door closing <input checked="" type="checkbox"/> Door stop button stops doors <input type="checkbox"/> Door stop button disables door opening <input type="checkbox"/> Door stop button disables door closing		
Miscellaneous		<input type="checkbox"/> Auto close doors if car away from recall floor <input type="checkbox"/> Nudge doors <input type="checkbox"/> Cancel Fire Phase II car calls if car is at a recall floor and DOB is pressed <input type="checkbox"/> Fire Phase II bypasses stop switch <input type="checkbox"/> Enable safe edge during firefighter service <input type="checkbox"/> Fire Phase II cancel car call upon door reopen <input type="checkbox"/> Keep doors open during Fire Phase II <input checked="" type="checkbox"/> Car emergency stop switch cancels car calls <input checked="" type="checkbox"/> Do not move car to next floor after an emergency stop <input checked="" type="checkbox"/> Enable the in-car fire switch upon power up <input checked="" type="checkbox"/> Synch towards the fire recall floor <input type="checkbox"/> Enable in-car fire switch if doors have opened once <input type="checkbox"/> Disable door contact monitoring during fire phase II <input type="checkbox"/> New car call registration cancels previous car call		

- **Fire Phase II Recall Conditions:** One of the following conditions is necessary to initiate Fire Phase II recall when the Fire Phase II switch is deactivated.
 - No recall: Never recall.
 - Recall: Always initiate recall.
 - Doors open or closed: Initiate recall only if the doors are fully open or closed.
 - Phase 1 and doors open: Initiate recall only if Phase I is still active and the doors are fully open.
 - Phase I and doors open or closed: Initiate recall only if Phase I is still active and the doors are fully open or closed.
 - Phase I and doors opened once: Initiate recall only if Phase I is active and the doors have been opened at least once at the floor.
 - Doors open: Initiate recall only if the doors are fully open.

- **Fire Phase II hold conditions:** One of the following conditions is required to put the car on Fire Phase II Hold when the switch is turned to the Hold position.
 - **Never:** Never put the car on Fire Phase II Hold.
 - **Not on Phase I:** Initiate Fire Phase II Hold if Fire Phase I is not active.
 - **Not on Phase I and doors open:** Initiate Fire Phase II Hold if Fire Phase I is not active and the elevator doors are fully open.
 - **Unconditional hold:** Put the car on Fire Phase II Hold unconditionally.
 - **Doors open hold:** Initiate Fire Phase II Hold only if doors are fully open.
 - **Phase I and doors open:** Put the car on Fire Phase II Hold if Fire Phase I is active and the doors are fully open.
- **Put car on Fire Phase II when:** One of the following conditions is required to activate in-car firefighter operation when the in-car fire fighter switch is activated
 - **Unqualified:** Put the car on Fire Phase II unconditionally.
 - **Recall completes:** Put the car on Fire Phase II when the recall is complete.
 - **Recall completes and Primary ON:** Put the car on Fire Phase II when the recall is complete and the Primary Fire recall switch is in the ON position.
- **Take car off Fire Phase II when:** One of the following conditions is required to take the car off in-car firefighter operation.
 - **Unqualified:** Take car off Fire Phase II when the in-car switch is deactivated.
 - **Recall completes:** Take car off Fire Phase II when the recall is complete and the in-car switch is deactivated.
 - **Recall completes and Primary ON:** Take the car off Fire Phase II when the recall is complete, the in-car switch is deactivated and the Primary Fire Recall switch is in the ON position.
 - **Primary OFF:** Take the car off Fire Phase II when the Primary Fire Recall switch is in the OFF position.
- **Put car on Fire Phase II during Fire Phase II recall when:** One of the following conditions is required to put the car on Phase II during Phase II recall if the Phase II Switch is reactivated.
 - **None:** Never re-initiate Phase II once Phase II recall has been activated.
 - **Unconditional:** Phase II will be re-activated unconditionally.
 - **Doors are not closed:** Phase II will be re-activated only if the doors are not closed.
 - **Doors not closed away from recall floor:** Phase II will be re-activated only if the car is away from the recall floor and the doors are not closed.
- **Put car on Phase II hold when:** One of the following conditions is required to activate Fire Phase II Hold when.
 - **Never:** Never activate Phase II Hold.
 - **Not on Phase I:** Initiate Phase II Hold if Phase I is not activated.
 - **Not on Phase I and doors open:** Initiate Phase II Hold if Phase I is not activated and the doors are fully open.
 - **Unconditional hold:** Phase II Hold will be activated unconditionally.
 - **Doors open hold:** Phase II Hold will be activated only if the doors are fully open.
 - **Phase I and doors open:** Phase II Hold will be activated only if Phase I is active and the doors are fully open.

- During Fire Phase II Hold:
 - Keep doors open and disable door close button): Hold the car doors open during Fire Phase II Hold, bypassing the Door Close Button.
 - Cancel car calls: During Fire Phase II Hold, cancel all car calls and prevent registration of new car calls.
- Conditions for stopping / disabling doors:
 - Emergency stop switch stops doors.
 - Emergency stop switch disables door opening.
 - Emergency stop switch disables door closing.
 - Door stop button stops doors.
 - Door stop button disables door opening.
 - Door stop button disables door closing.
- Miscellaneous:
 - Auto close doors if car away from recall floor: Unless the Door Open Button is pressed, always keep the doors closed when away from the recall floor.
 - Nudge doors: Close doors at nudging speed during in-car firefighter operation.
 - Cancel Fire Phase II car calls if car is at recall floor and DOB is pressed: Cancel car calls during in-car firefighter operation if the car is at the recall floor and the Door Open Button is pressed.
 - Fire Phase II bypasses stop switch: Bypass the Stop switch during in-car firefighter operation.
 - Enable safe edge during firefighter service: Enable the door safety edge during in-car firefighter operation.
 - Fire Phase II cancel car call upon door reopen: During in-car firefighter operation, cancel car calls if a door reopens.
 - Keep doors open during Fire Phase II: Enabling this option will cause the doors to reopen as soon as the Door Close button is deactivated, even if the doors have fully closed (as long as the car is not moving).
 - Car emergency stop switch cancels car calls: Cancel car calls when the car emergency stop switch is activated while on in-car firefighter operation.
 - Do not move car to next floor after an emergency stop: During in-car firefighter operation, the car shall not be moved to the next floor after an emergency stop.
 - Enable the in-car fire switch upon power up: In order to comply with ASME A17.1-2000 code, when this parameter is checked, after power up, changes to the In-car Fire Switch are recognized regardless of the position of the doors, until the doors have fully opened once.
 - Sync towards the fire recall floor: The car shall move towards the fire recall floor when performing a floor sync operation.
 - Enable in-car fire switch if doors have opened once: The In-car Fire Switch shall be recognized regardless of the position of the doors, if the doors have been fully opened once at the fire recall level. **Note** - This option must be checked for elevators with manual doors that must comply with the ASME A17.1-2000 or later code.
 - Disable door contact monitoring during fire phase II: Specifies that door contact monitoring shall be disabled during fire phase II (required for New York 2000 fire code).
 - New car call registration cancels previous car call: Specifies that registration of a new car call shall cancel the previous call (required for British Fire Code EN 81-72).

Fire Code - In-Car - Front / Rear Tabs

Determine how the doors shall open and close during Fire Service - In-Car operation.

At Recall Floor - Away from Recall Floor Determine how the doors shall open and close when the car is at the recall floor and when the car is away from the recall floor. The parameters and descriptions are the same for both At Recall Floor and Away From Recall Floor and for both Front and Rear tabs.

Opening When “MCE Controlled” is checked, the following parameters determine what action will cause the doors to open when the car arrives at a floor.

Mechanism:

- **Automatic:** With the presence of door open intent, doors shall open automatically upon arrival at the floor. When the car is sitting idle, the doors will open and remain open.
- **Constant pressure on door open button:** Doors shall not open automatically upon arrival at a floor. Constant pressure activation of the door open button is required to open the doors. If the door open button is released before the doors are fully open, the doors shall re-close.
- **Momentary pressure on door open button:** Doors shall not open automatically upon arrival at a floor. Momentary activation of the door open button shall initiate opening the doors.

Closing When “MCE Controlled” is checked, the following parameters determine what action will cause the doors to close.

Mechanism:

- **Automatic:** With the absence of door open intent, the doors shall close automatically upon dwell time expiration.
- **Passenger initiated:** Doors shall not close automatically. The passenger initiated action selected below shall be required to cause the door to close.
 - **Door close button:**
 - **Does not close doors:** Doors shall not respond to door close button.
 - **Constant pressure:** Doors shall close with constant pressure on door close button. If the door close button is released before the doors are fully closed, the doors shall reopen and stand open.
 - **Momentary pressure:** Doors shall close with momentary pressure on door close button. Operational door reopening devices shall initiate door reopening, and once fully open the doors shall stand open until the door close button is again activated.
 - **Momentary pressure if a car call is registered:** Doors shall close with momentary pressure on door close button if a car call is registered. Operational door reopening devices shall initiate door reopening, and once fully open the doors shall stand open until the door close button is again activated.
 - **Constant pressure if a car call is registered:** Doors shall close with constant pressure on door close button if a car call is registered. If the door close button has been released, operational door reopening devices shall initiate door reopening, and once fully open the doors shall stand open until the door close button is again activated.
 - **Car Call Button:**
 - **Does not close doors:** Doors shall not close in response to car call button.
 - **Constant pressure:** Doors will close with constant pressure on car call button. Operational door reopening devices shall initiate door reopening, and once fully open the doors shall stand open until the door close button is again activated.
 - **Momentary pressure:** Doors shall close with momentary pressure on car call button. Operational door reopening devices shall initiate door reopening, and once fully open the doors shall stand open until the door close button is again activated.
 - **Car call registration closes doors:** Doors will close if a car call is registered.

Fire Code - In-Car Recall - Front / Rear Tabs

Determine how the doors shall open and close during Fire Service In-Car Recall operation. The parameters and descriptions are the same for both Front and Rear tabs.

Opening When “MCE controlled” is checked, the following parameters determine what action will cause the doors to open when the car arrives at a floor.

Mechanism:

- **Automatic:** With the presence of door open intent, doors shall open automatically upon arrival at the floor. When the car is sitting idle, the doors will open and remain open.
- **Constant pressure on door open button:** Doors shall not open automatically upon arrival at a floor. Constant pressure activation of the door open button is required to open the doors. If the door open button is released before the doors are fully open, the doors shall re-close.
- **Momentary pressure on door open button:** Doors shall not open automatically upon arrival at a floor. Momentary activation of the door open button initiates door opening.

Closing When “MCE controlled” is checked, the following parameters determine what action will cause the doors to close.

Mechanism:

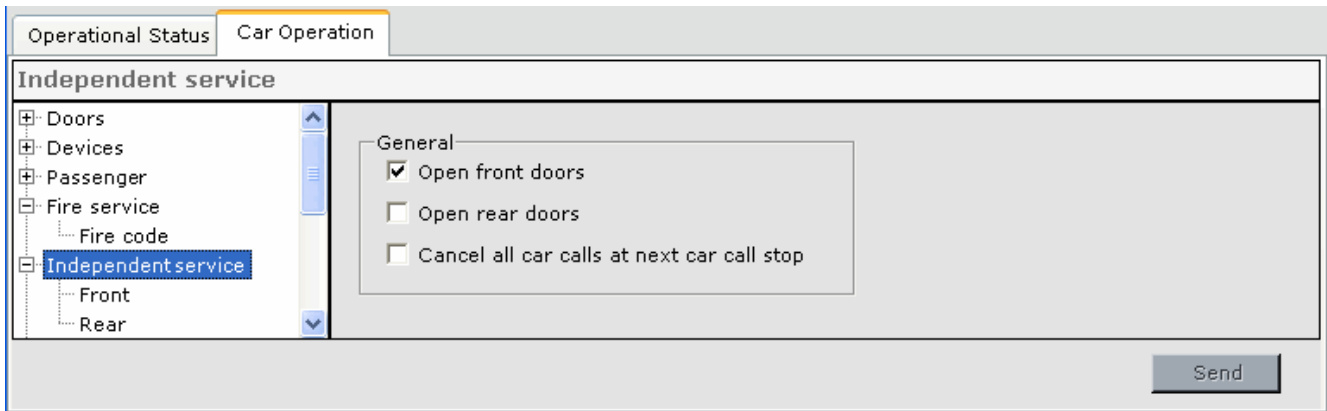
- **Automatic:** With the absence of door open intent, the doors shall close automatically upon dwell time expiration.
- **Passenger initiated:** Doors shall not close automatically. The passenger initiated action selected below shall be required to cause the door to close.
 - **Door close button:**
 - **Does not close doors:** Doors shall not respond to door close button.
 - **Constant pressure:** Doors shall close with constant pressure on door close button. If the door close button is released before the doors are fully closed, the doors shall reopen and stand open.
 - **Momentary pressure:** Doors shall close with momentary pressure on door close button. Operational door reopening devices shall initiate door reopening, and once fully open the doors shall stand open until the door close button is again activated.
 - **Momentary pressure if a car call is registered:** Doors shall close with momentary pressure on door close button if a car call is registered. Operational door reopening devices shall initiate door reopening, and once fully open the doors shall stand open until the door close button is again activated.
 - **Car Call Button:**
 - **Does not close doors:** Doors shall not close in response to car call button.
 - **Constant pressure:** Doors will close with constant pressure on car call button. Operational door reopening devices shall initiate door reopening, and once fully open the doors shall stand open until the door close button is again activated.
 - **Momentary pressure:** Doors shall close with momentary pressure on car call button. Operational door reopening devices shall initiate door reopening, and once fully open the doors shall stand open until the door close button is again activated.
- **Car call registration closes doors:** Doors will close if a car call is registered.

 **Note**

For elevators that must comply with the ASME A17.1-2000 and later code, if the door is power-operated and vertically sliding, the *Closing Mechanism* parameter (Fire Code > In-Car Recall > Front / Rear) must be set to *Passenger initiated* and the *Door close button* parameter must be set to *Constant Pressure*.

Car Operation - Independent Service Tab

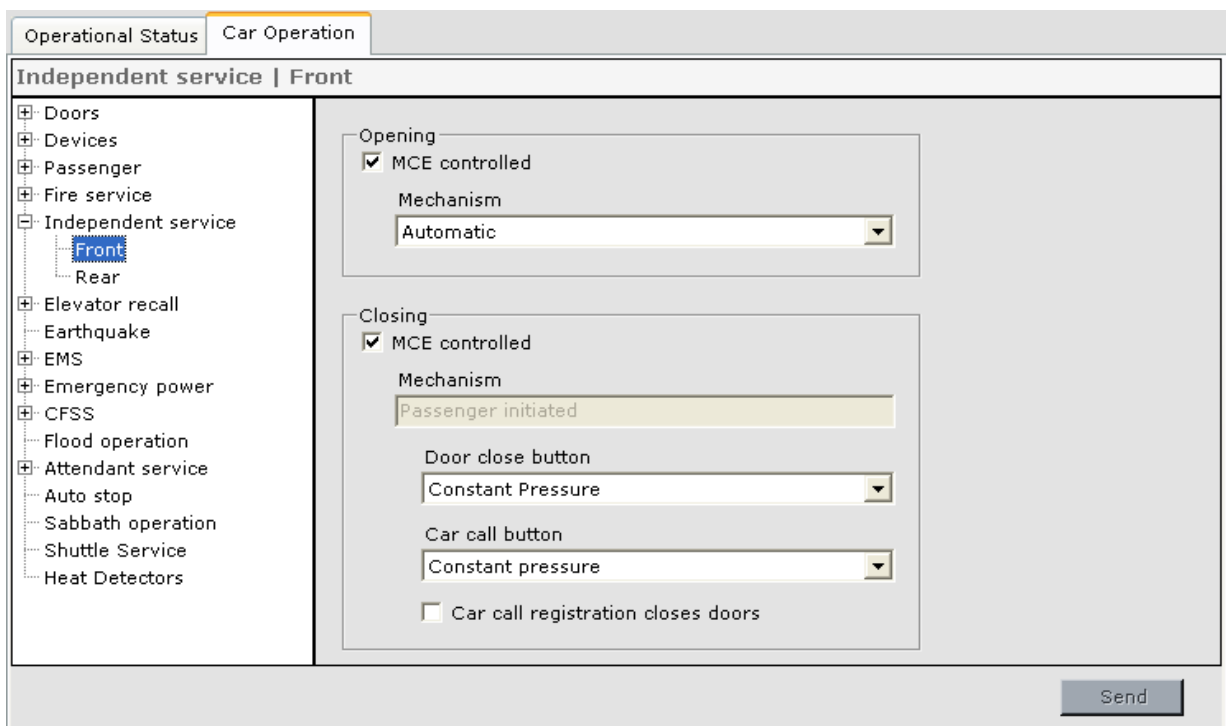
This tab sets parameters associated with Independent and Attendant Service operation.



General

- **Open front doors:** If the doors are closed when the car is placed on Independent Service, the front doors shall be opened.
- **Open rear doors:** If the doors are closed when the car is placed on Independent Service, the rear doors shall be opened.
- **Cancel all car calls at next car call stop:** Specifies that all car calls be canceled after the elevator completes the first car call stop

Independent Service - Front / Rear Tabs Determine how the doors shall open and close during Independent Service operation. The parameters and descriptions are the same for both Front and Rear tabs.



Opening When “MCE controlled” is checked, the following parameters determine what action will cause the doors to open when the car arrives at a floor.

Mechanism:

- Automatic: With the presence of door open intent, doors shall open automatically upon arrival at the floor. When the car is sitting idle, the doors will open and remain open.
- Momentary pressure on door open button: Doors shall not open automatically upon arrival at a floor. Momentary activation of the door open button initiates door opening.

Closing When “MCE controlled” is checked, the following parameters determine what action will cause the doors to close.

Mechanism:

- Automatic: This option is not available on Independent service.
- Passenger initiated: Doors shall not close automatically. The passenger initiated action selected below shall be required to cause the door to close.
 - Door close button:
 - Does not close doors: Doors shall not respond to door close button.
 - Constant pressure: Doors shall close with constant pressure on door close button. If the door close button is released before the doors are fully closed, the doors shall reopen and stand open.
 - Momentary pressure: Doors shall close with momentary pressure on door close button. Operational door reopening devices shall initiate door reopening, and once fully open the doors shall stand open until the door close button is again activated.
 - Momentary pressure if a car call is registered: Doors shall close with momentary pressure on door close button if a car call is registered. Operational door reopening devices shall initiate door reopening, and once fully open the doors shall stand open until the door close button is again activated.
 - Car Call Button:
 - Does not close doors: Doors shall not close in response to car call button.
 - Constant pressure: Doors will close with constant pressure on car call button. Operational door reopening devices shall initiate door reopening, and once fully open the doors shall stand open until the door close button is again activated.
 - Momentary pressure: Doors shall close with momentary pressure on car call button. Operational door reopening devices shall initiate door reopening, and once fully open the doors shall stand open until the door close button is again activated.
 - Car call registration closes doors: Doors will close if a car call is registered.

Car Operation - Elevator Recall Tab

Elevator Recall switch parameters determine how the car will respond during Elevator Recall operation (when the Elevator Recall Switch is activated).

General

- **Recall floor:** Specifies the floor to which the elevator is recalled.
 - **Next available floor** - Causes the car to stop at the next available floor in the direction of travel if “Car call disposition” is set to “Cancel immediately”. If car calls are allowed to remain registered, the elevator will remain at the floor at which the last registered car call was answered.
 - **“Floor label”** - Specifies the floor to which the elevator shall be recalled.
- **Switch priority:** Determines which switch has priority if more than one Elevator Recall Switch is activated simultaneously. (#1 is highest priority.)
- **Car call disposition:** Determines how existing car calls are handled when the Elevator Recall Switch is activated.
 - **Service existing car calls:** All previously registered car calls remain registered and the elevator is allowed to answer the car calls.
 - **Cancel immediately:** All previously registered car calls are immediately canceled.
 - **Cancel at the next car call stop:** All previously registered car calls remain registered. When the elevator answers its next car call, all remaining car calls are canceled.

- **Allow new car call registration:** Determines if new car calls shall be registered during the “first phase” of elevator Recall Operation. During the “first phase” of Elevator Recall Operation, the elevator must handle existing car calls. This parameter determines if new car calls shall be registered during the “first phase” of Elevator Recall Operation. Once the elevator has finished answering all registered car calls, the “second phase” commences, and the elevator is taken to the recall floor. No car calls are accepted during the “second phase.”
- **Override Attendant service:** Elevator Recall operation shall override Attendant service.
- **Override CFSS mode 1:** Elevator Recall operation shall override CFSS mode 1.
- **Override CFSS mode 2:** Elevator Recall operation shall override CFSS mode 2.
- **Override EMS mode 1:** Elevator Recall operation shall override EMS mode 1.
- **Override EMS mode 2:** Elevator Recall operation shall override EMS mode 2.
- **Override Independent service:** Elevator Recall operation shall override Independent service.
- **Switch type:** Indicates the type of Elevator Recall Switch.
 - **Continuous closure:** The controller performs the Elevator Recall Operation as long as the switch remains closed. If the switch opens midway through the process, the recall operation is terminated.
 - **Momentary closure:** A momentary closure of the switch causes the controller to perform the complete Elevator Recall Operation. Once completed, the controller will return to normal service.
- **After recall, activate independent service:** If enabled, Independent service will be activated after recall is complete. The car remains on Independent Service until the continuous closure switch is opened.

Door Operation Front Determines how the elevator front doors shall operate once the elevator has arrived at the recall floor (after all car calls have been answered).

- **Keep closed:** The front doors shall remain closed.
- **Keep open:** The front doors shall open and remain open.
- **Open doors for “xx” sec:** The front doors shall open for the time specified, then reclose.
- **Respond to door open button:** Specifies that the front doors shall respond to activation of the front door open button (once the car has arrived at the recall floor). If this option is selected, the front door open button remains operative at all times. If not selected, the front door open button will be rendered inoperative when the front doors are closed at the recall floor. (Note: The door open button will always remain operative when the associated doors are open).

Door Operation Rear Determines how the elevator rear doors shall operate once the elevator has arrived at the recall floor (after all car calls have been answered).

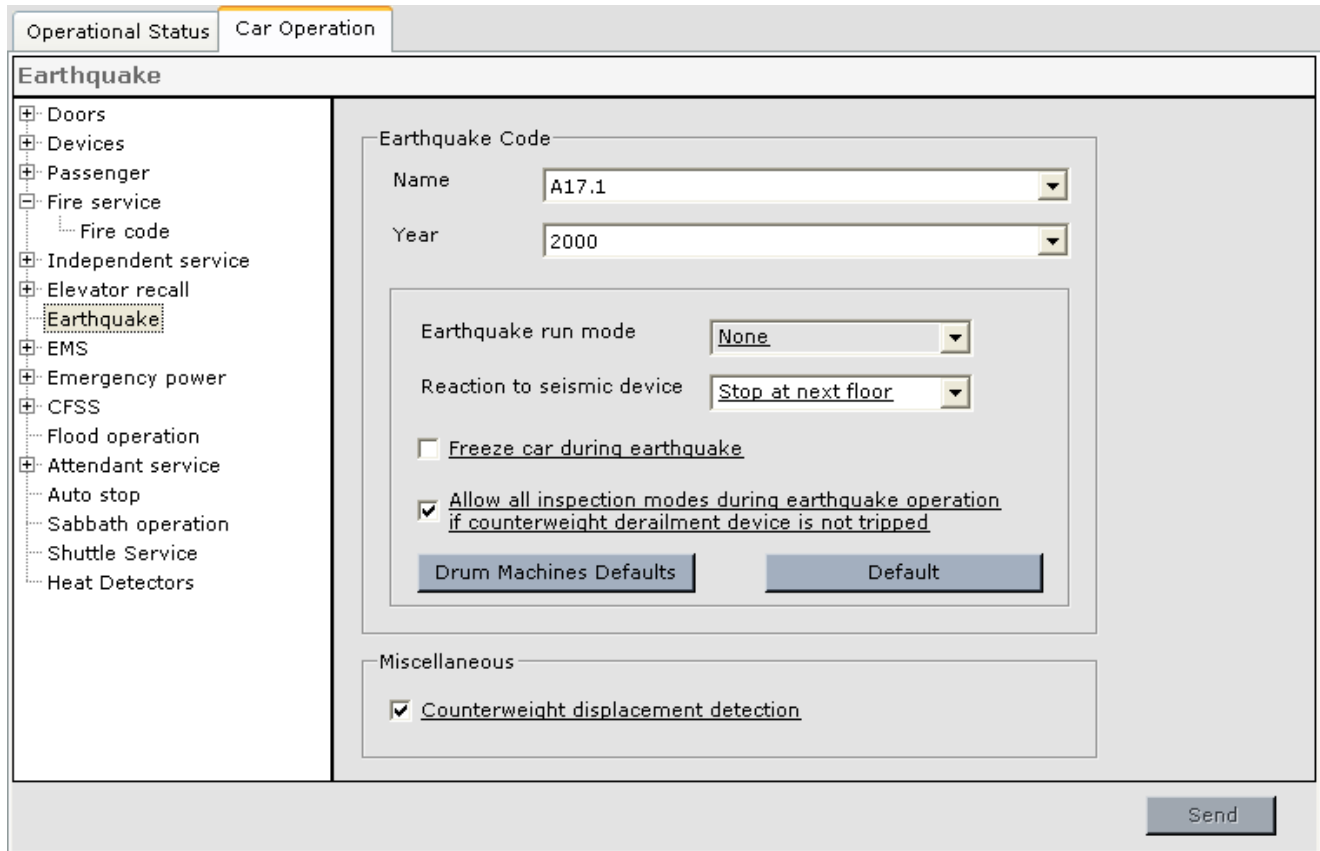
- **Keep closed:** The rear doors shall remain closed.
- **Keep open:** The rear doors shall open and remain open.
- **Open doors for “xx” sec:** The rear doors shall open for the amount of time specified, the reclose.
- **Respond to door open button:** Specifies that the rear doors shall respond to activation of the rear door open button (once the car has arrived at the recall floor). If this option is selected, the rear door open button remains operative at all times. If not selected, the rear door open button will be rendered inoperative when the rear doors are closed at the recall floor. (Note: The door open button will always remain operative when the associated doors are open).

Hoistway Access Recall This control allows the recall operation, based on the parameter settings for the selected recall switch (1 - 6), to be activated by one of the Hoistway Access direction switches. This allows the mechanic to recall the car prior to placing it on access operation.

- **Assign this recall to the following hoistway access input:**
 - **No access recall:**
 - **ATU - Access Top Up:** Activation of the ATU switch/input shall cause the car to recall per the selected recall switch (1 - 6) parameter settings.
 - **ATD - Access Top Down:** Activation of the ATD switch/input shall cause the car to recall per the selected recall switch (1 - 6) parameter settings.
 - **ABU - Access Bottom Up:** Activation of the ABU switch/input shall cause the car to recall per the selected recall switch (1 - 6) parameter settings.
 - **ABD - Access Bottom Down:** Activation of the ABD switch/input shall cause the car to recall per the selected recall switch (1 - 6) parameter settings.

Car Operation - Earthquake Tab

Allows selection of operating parameters during earthquake operation. Please refer to “Installing the Earthquake Sensor” on page 3-21 for additional information.



The screenshot shows the 'Car Operation' tab in the iView interface. The 'Earthquake' section is active, displaying a tree view on the left and configuration options on the right. The tree view includes: Doors, Devices, Passenger, Fire service (with sub-item Fire code), Independent service, Elevator recall, Earthquake (selected), EMS, Emergency power, CFSS, Flood operation, Attendant service, Auto stop, Sabbath operation, Shuttle Service, and Heat Detectors. The main configuration area is titled 'Earthquake Code' and includes:

- Name: A17.1
- Year: 2000
- Earthquake run mode: None
- Reaction to seismic device: Stop at next floor
- Freeze car during earthquake
- Allow all inspection modes during earthquake operation if counterweight derailment device is not tripped
- Buttons: Drum Machines Defaults, Default

 Below this is a 'Miscellaneous' section with:

- Counterweight displacement detection

 A 'Send' button is located at the bottom right of the configuration area.

Earthquake Code Select the earthquake code and version/year being used.



Caution

Changing earthquake parameter settings may cause you to be out of compliance with the selected code and may require a variance. Note that some parameter settings are underlined, indicating that the setting is in compliance with the selected code. **If a setting is changed to one that does not comply with the selected code, it will appear in RED.**

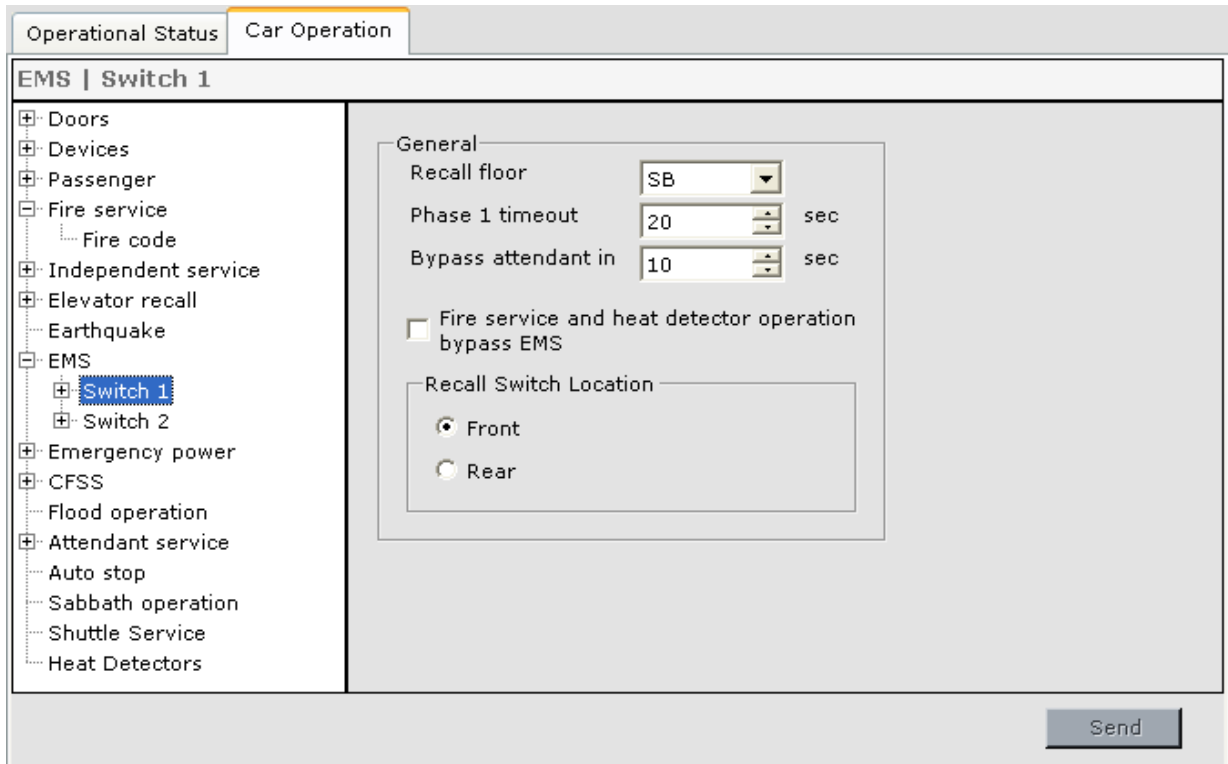
- **Earthquake run mode:** Specifies when the elevator should be allowed to run while under Earthquake mode of operation. The elevator is allowed to run at a reduced speed (not to exceed 150 fpm) as long as the counterweight has not been displaced from its guide rails.
 - **None:** The car is not allowed to run in earthquake mode.
 - **Delay:** The car is allowed to run after a delay.
 - **Fire only:** The car is allowed to run only during fire service. The car is also allowed to run with the counterweight derailed if the car is below the counterweight.
- **Reaction to Seismic Device:** Determines how the elevator should react to the activation of a seismic switch.
 - **Emergency Stop:** Perform an Emergency stop then, after a brief delay, proceed to next available floor in a direction away from the counterweight.
 - **Stop at Next Floor:** Stop at next available floor in direction of travel.
- **Freeze Car During Earthquake:** Stop the car immediately during earthquake activity and keep it shut down as long as the earthquake remains active. (Title 8 earthquake compliance.)
- **Allow all inspection modes during earthquake operation if the counterweight derailment device is not tripped:** Specifies that the elevator should be allowed to run under all inspection modes of operation if the counterweight has not been displaced from its guide rails. If the counterweight is derailed, only Cartop Inspection is allowed to run during earthquake operation.
- **Drum Machine Defaults button:** Sets the earthquake parameters to the code specified default values for a drum machine installation.
- **Default button:** Sets the earthquake parameters to the code specified default values.

Miscellaneous: •

- **Counterweight displacement detection:** If the job has a device to detect displacement of the counterweight, enable this check box.

Car Operation - EMS Tab

Allows selection of operating parameters during Emergency Medical Service operation.



The screenshot shows the 'Car Operation' tab in the iView interface. The left sidebar contains a tree view with the following items: Doors, Devices, Passenger, Fire service (with sub-item Fire code), Independent service, Elevator recall, Earthquake, EMS (with sub-items Switch 1 and Switch 2), Emergency power, CFSS, Flood operation, Attendant service, Auto stop, Sabbath operation, Shuttle Service, and Heat Detectors. The 'Switch 1' item is selected. The main panel displays the 'General' settings for EMS:

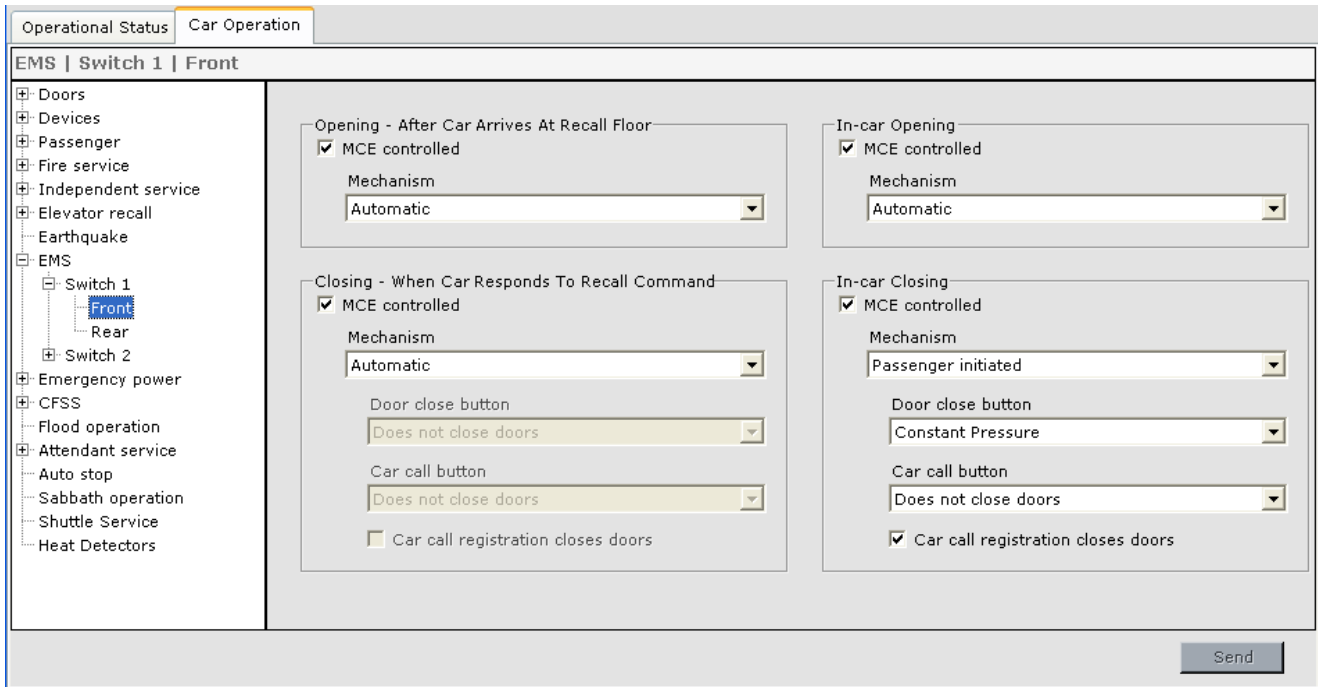
- Recall floor: SB (dropdown menu)
- Phase 1 timeout: 20 (spin box) sec
- Bypass attendant in: 10 (spin box) sec
- Fire service and heat detector operation bypass EMS
- Recall Switch Location:
 - Front
 - Rear

A 'Send' button is located at the bottom right of the main panel.

General

- **Recall Floor:** Determines the recall floor for EMS service.
- **Phase 1 Timeout:** Allows a time period to be set after which EMS Phase 1 service will time out without activation of Phase 2 (in-car switch).
- **Bypasses Attendant in XX Seconds:** Allows a time period to be set after which EMS service will bypass Attendant service.
- **Fire service and heat detector operation bypass EMS:** If enabled, Fire Service or Heat Detector operation will immediately bypass EMS service.
- **Recall Switch Location (Front or Rear):** Indicates the location of the EMS recall switch (front riser or rear riser).

EMS Switch 'n' - Front / Rear Tabs The EMS - Front and Rear parameters determine how the front and rear doors will operate during EMS Operation. The parameters and descriptions are the same for both Switch 1 and 2 and for both Front and Rear tabs.



Opening - After Car Arrives At Recall Floor When “MCE controlled” is checked, the following parameters determine what action will cause the doors to open when the car arrives at a floor.

Mechanism:

- **Automatic:** With the presence of door open intent, doors shall open automatically upon arrival at the floor. When the car is sitting idle, the doors will open and remain open.
- **Constant pressure on door open button:** Doors shall not open automatically upon arrival at a floor. Constant pressure activation of the door open button is required to open the doors. If the door open button is released before the doors are fully open, the doors shall re-close.
- **Momentary pressure on door open button:** Doors shall not open automatically upon arrival at a floor. Momentary activation of the door open button initiates door opening.

In-car Opening When “MCE controlled” is checked, the following parameters determine what action will cause the doors to open when the car arrives at a floor.

Mechanism:

- **Automatic:** With the presence of door open intent, doors shall open automatically upon arrival at the floor. When the car is sitting idle, the doors will open and remain open.
- **Constant pressure on door open button:** Doors shall not open automatically upon arrival at a floor. Constant pressure activation of the door open button is required to open the doors. If the door open button is released before the doors are fully open, the doors shall re-close.
- **Momentary pressure on door open button:** Doors shall not open automatically upon arrival at a floor. Momentary activation of the door open button initiates door opening.

Closing - When Car Responds to Recall Command When “MCE controlled” is checked, the following parameters determine what action will cause the doors to close.

Mechanism:

- **Automatic:** With the presence of door open intent, doors shall open automatically upon arrival at the floor. When the car is sitting idle, the doors will open and remain open.
- **Passenger initiated:** Doors shall not close automatically. The passenger initiated action selected below shall be required to cause the door to close.
 - **Door close button:**
 - **Does not close doors:** Doors shall not respond to door close button.
 - **Constant pressure:** Doors shall close with constant pressure on door close button. If the door close button is released before the doors are fully closed, the doors shall reopen and stand open.
 - **Momentary pressure:** Doors shall close with momentary pressure on door close button. Operational door reopening devices shall initiate door reopening, and once fully open the doors shall stand open until the door close button is again activated.
 - **Momentary pressure if a car call is registered:** Doors shall close with momentary pressure on door close button if a car call is registered. Operational door reopening devices shall initiate door reopening, and once fully open the doors shall stand open until the door close button is again activated.
 - **Car Call Button:**
 - **Does not close doors:** Doors shall not close in response to car call button.
 - **Constant pressure:** Doors will close with constant pressure on car call button. Operational door reopening devices shall initiate door reopening, and once fully open the doors shall stand open until the door close button is again activated.
 - **Momentary pressure:** Doors shall close with momentary pressure on car call button. Operational door reopening devices shall initiate door reopening, and once fully open the doors shall stand open until the door close button is again activated.
 - **Car call registration closes doors:** Doors will close if a car call is registered.

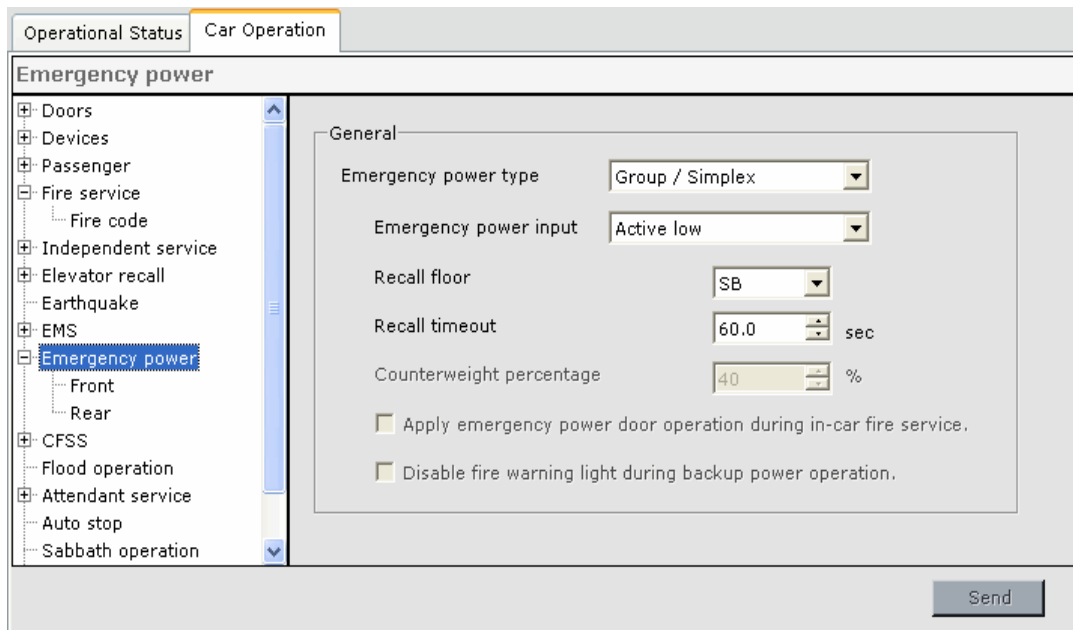
In-car Closing When “MCE controlled” is checked, the following parameters determine what action will cause the doors to close.

Mechanism:

- **Automatic:** With the presence of door open intent, doors shall open automatically upon arrival at the floor. When the car is sitting idle, the doors will open and remain open.
- **Passenger initiated:** Doors shall not close automatically. The passenger initiated action selected below shall be required to cause the door to close.
 - **Door close button:**
 - **Does not close doors:** Doors shall not respond to door close button.
 - **Constant pressure:** Doors shall close with constant pressure on door close button. If the door close button is released before the doors are fully closed, the doors shall reopen and stand open.
 - **Momentary pressure:** Doors shall close with momentary pressure on door close button. Operational door reopening devices shall initiate door reopening, and once fully open the doors shall stand open until the door close button is again activated.
 - **Momentary pressure if a car call is registered:** Doors shall close with momentary pressure on door close button if a car call is registered. Operational door reopening devices shall initiate door reopening, and once fully open the doors shall stand open until the door close button is again activated.
 - **Car Call Button:**
 - **Does not close doors:** Doors shall not close in response to car call button.
 - **Constant pressure:** Doors will close with constant pressure on car call button. Operational door reopening devices shall initiate door reopening, and once fully open the doors shall stand open until the door close button is again activated.
 - **Momentary pressure:** Doors shall close with momentary pressure on car call button. Operational door reopening devices shall initiate door reopening, and once fully open the doors shall stand open until the door close button is again activated.
- **Car call registration closes doors:** Doors will close if a car call is registered.

Car Operation - Emergency Power Tab

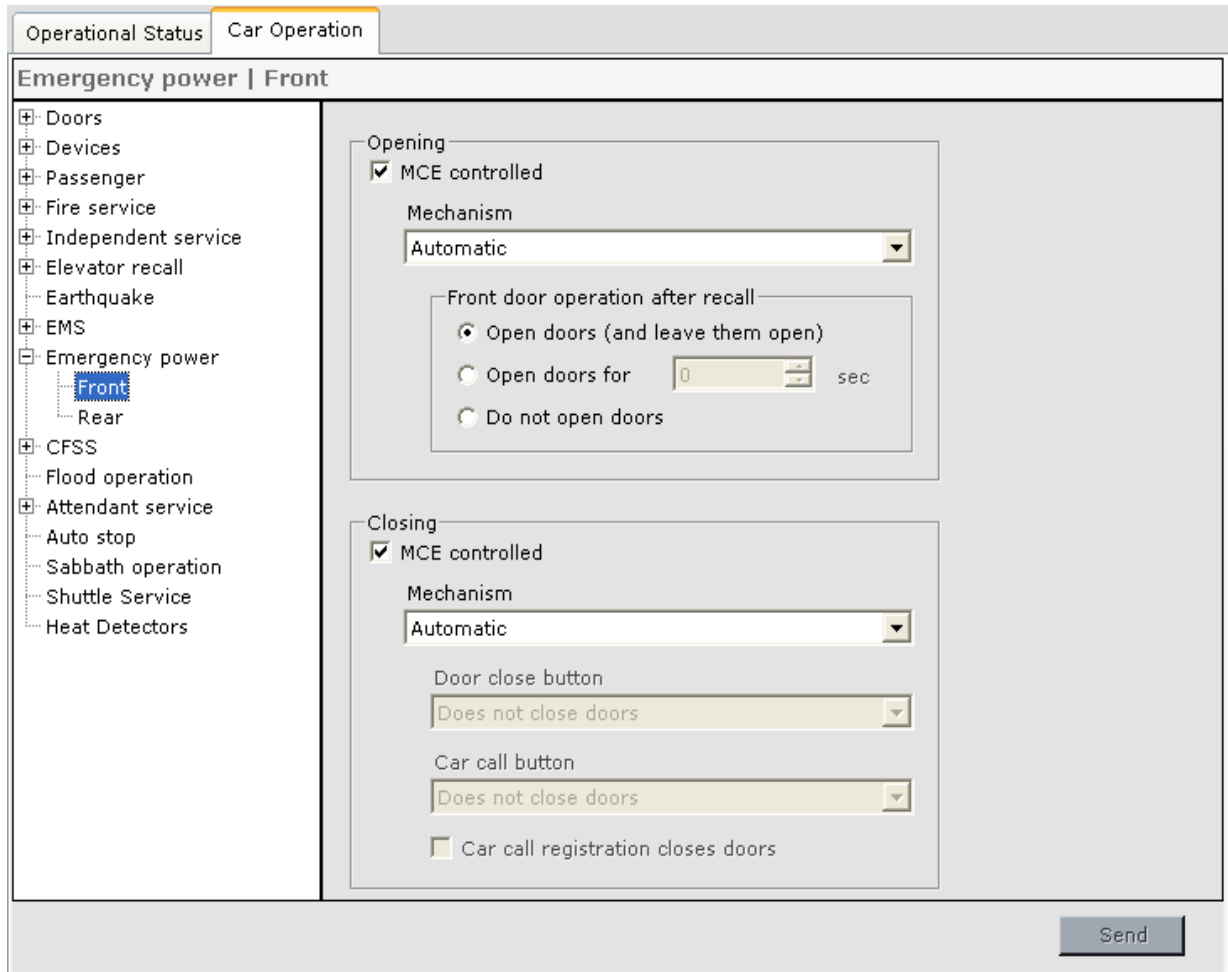
Determines the car reaction to loss of commercial power.



General

- **Emergency power type:**
 - **Group/Simplex:** Select this option for a simplex or for a car that is part of a group that controls the car during emergency power generator operation.
 - **Overlay:** Select this option if the car is controlled via discrete inputs from a remote emergency power overlay controller during emergency power generator operation.
 - **Backup power:** Select this option if the car is using a battery backup unit, e.g. the Traction Auxiliary Power Supply (TAPS) from MCE.
- **Emergency power input:** (does not apply to Backup power option)
 - **Active low:** Low (ground) voltage at the EPI input will cause emergency power to become active.
 - **Active high:** High (110VDC) voltage at the EPI input will cause emergency power to become active.
- **Recall Floor:** Set the recall floor for this car (does not apply to Backup power option).
- **Recall Timeout:** Defines the period of time after which the controller will stop attempting to recall this car after a power failure has occurred (does not apply to Backup power option).
- **Counterweight percentage:** The weight of the counterweight divided by the sum of the full load weight plus the weight of the cab. (applies only to Backup power option).
- **Apply emergency power door operation during in-car fire service:** The emergency power door operation settings shall be used, instead of the in-car fire service door operation settings, when the car is on in-car fire service (applies only to Backup power option).
- **Disable fire warning light during backup power recall:** The fire warning light and buzzer shall be disabled during backup power recall operation (applies only to Backup power option).

Emergency Power - Front / Rear Tabs The Front and Rear door parameters determine how the front and rear doors will operate during Emergency Power Operation. The parameter descriptions are the same for both Front and Rear tabs.



Opening When “MCE controlled” is checked, the following parameters determine what action will cause the doors to open when the car arrives at a floor.

- Mechanism:
 - Automatic: With the presence of door open intent, doors shall open automatically upon arrival at the floor. When the car is sitting idle, the doors will open and remain open.
 - Momentary pressure on door open button: Doors shall not open automatically upon arrival at a floor. Momentary activation of the door open button initiates door opening.
- Front door operation after recall: After Emergency Power Recall is completed, the doors shall open as follows:
 - Open doors (and leave them open): Open the doors and leave them open.
 - Open doors for ‘xx’ sec: Open the doors for the time designated and then close them.
 - Do not open doors: The doors shall remain closed.

**Note**

Per the elevator code, the *Front /Rear door operation after recall* parameter (Emergency Power > Front / Rear > Opening) must be set to *Do not open doors if*:

- the car has a backup power source, e.g., MCE's TAPS, and
- door closing is not automatic, e.g., the door *Mechanism* parameter (Emergency Power > Front / Rear > Closing) is set to *Passenger initiated*.

Closing When “MCE controlled” is checked, the following parameters determine what action will cause the doors to close.

Mechanism:

- **Automatic:** With the presence of door open intent, doors shall open automatically upon arrival at the floor. When the car is sitting idle, the doors will open and remain open.
- **Passenger initiated:** Doors shall not close automatically. The passenger initiated action selected below shall be required to cause the door to close.
 - **Door close button:**
 - **Does not close doors:** Doors shall not respond to door close button.
 - **Constant pressure:** Doors shall close with constant pressure on door close button. If the door close button is released before the doors are fully closed, the doors shall reopen and stand open.
 - **Momentary pressure:** Doors shall close with momentary pressure on door close button. Operational door reopening devices shall initiate door reopening, and once fully open the doors shall stand open until the door close button is again activated.
 - **Car Call Button:**
 - **Does not close doors:** Doors shall not close in response to car call button.
 - **Constant pressure:** Doors will close with constant pressure on car call button. Operational door reopening devices shall initiate door reopening, and once fully open the doors shall stand open until the door close button is again activated.
 - **Momentary pressure:** Doors shall close with momentary pressure on car call button. Operational door reopening devices shall initiate door reopening, and once fully open the doors shall stand open until the door close button is again activated.
 - **Car call registration closes doors:** Doors will close if a car call is registered.

Car Operation - CFSS Tab

The CFSS (Commandeer For Special Service) tabs allow you to configure two “commandeer” modes. When active, these modes allow the elevator to be operated independently as configured for the commandeer mode selected. [Please refer to “CFSS \(Commandeer for Special Services\)” on page 10-9](#) also.

General

- **Fire service and heat detector operation bypass CFSS:** Specifies that CFSS will be bypassed when the car is in Fire Service operation and Heat Detector operation.

Recall When a CFSS mode is activated, the affected car is recalled to the activation floor according to the behavior defined by these settings.

- **Disposition of existing car calls:** Once a car has been assigned a CFSS call, these settings determine how existing car calls will be handled.
 - **Service existing car calls:** All currently registered car calls will be serviced before the car is recalled. Audio and visual indicators in the car will signal passengers.
 - **Cancel immediately:** Car calls are canceled and the car will proceed immediately to the recall floor. If this choice is selected, you may also choose to enable “Stop at next floor and cycle doors” in which case the car will stop at the next floor in its direction of travel and cycle its doors while using visual and audio indicators to signal passengers to exit. Once passengers have exited, the car will proceed to the recall floor.
 - **Cancel calls at next car call stop:** All remaining car calls will be cancelled at the cars next stop. Audio and visual indicators within the car will signal the passengers to exit.
- **Stop at next floor and cycle doors:** Allows passengers to exit if car calls are canceled.
- **Allow new car call registration:** Should be selected if “Recall empty car” is selected, to ensure recalling an empty car in case a passenger enters after hall call service is canceled.
- **Recall empty car:** Specifies that the recalled car must be empty. Select an appropriate “Disposition of existing car calls” option that will result in the car being empty. Once all car calls have been cleared, the car will close its doors and must then pass the empty car test (Empty Load Input = On, Car Not Empty Sensor Input = Off or car weight is below the Load Weigher Empty load threshold setting) before the Recall empty car timer expires.
- **Recall empty car timer:** This timer starts when all car calls have been cleared and the doors are fully closed. If the car has not passed the empty car test before this timer expires, it removes itself from CFSS service to allow the dispatcher to re-assign the CFSS call. If no car is available the CFSS call is canceled.
- **In-car visual indicator behavior:** The visual indicator may be set to remain off, light continuously, or light intermittently (Flash).
- **In-car audible indicator behavior:** The alarm may be set to remain off, sound constantly, or sound intermittently (Flash).
- **Cars on independent service are eligible for CFSS:** If enabled, a car currently operating on Independent Service mode may be assigned a CFSS call.
 - **Bypass independent service after “nnn” sec:** Determines the delay from when a car is assigned a CFSS call to when Independent Service is bypassed and the car begins CFSS mode.
- **Cars on attendant service are eligible for CFSS:** If enabled, a car currently operating on Attendant Service mode may be assigned a CFSS call.
 - **Bypass attendant service after “nnn” sec.** Determines the delay from when a car is assigned a CFSS call to when Attendant Service is bypassed and the car begins CFSS mode.
- **Bypass stop switch when car on CFSS recall:** Enable if activation of the in-car Stop switch should be ignored when the car is on commandeered operation.
- **CFSS recall timeout:** If the car has not answered the CFSS call before this timer times out, the car becomes ineligible for CFSS calls, thereby allowing the call to be re-assigned to another car. This timer also determines how long a recalled car will wait at the recall floor, for activation of the in-car CFSS service switch or the registration of a car call if there is no in-car CFSS service switch, before timing-out and returning to normal service.

In-car When a CFSS mode is selected, and after the recall is complete, these settings determine how in-car operation is invoked and how the car behaves during in-car CFSS operation.

- In-car visual indicator behavior while in-car CFSS is active. This setting defines how the in-car visual indicator (light, etc.) will behave while in-car CFSS is active.
 - Off: Indicator will remain off.
 - Solid: Indicator will light solidly.
 - Flash: Indicator will light intermittently (flash).
- In-car switch to activate CFSS:
 - No switch: Select if there is no switch in the car to activate CFSS. If selected, set the “Resume normal service xx seconds after answering last call” timer so that, after the period of inactivity it defines has passed, the car will automatically exit CFSS operation.
 - Constant Pressure (2-position switch): Select if there is a key or other constant-contact switch in the car to invoke in-car CFSS operation.
 - Momentary pressure (momentary switch): Select if there is a momentary-contact switch (spring-loaded key or other) in the car to invoke in-car CFSS operation. If selected, set the “Resume normal service xx seconds after answering last call” timer so that, after the period of inactivity it defines has passed, the car will automatically exit CFSS operation.
- Resume normal service after ‘xx’ seconds after answering last call: This determines how long a recalled car will wait after answering the last call before timing-out and returning to normal service.
- Permit in-car activation without recall first: If selected, in-car CFSS may be activated by an in-car switch without first initiating and completing a recall phase.
- Cancel remaining car calls after answering a car call: If enabled, after the first CFSS car call is answered, remaining calls are automatically canceled. Limits CFSS calls to one-at-a-time.
- Cancel car calls if doors are not fully closed: If enabled, during in-car CFSS operation, if the doors are not fully closed, new car calls may not be registered and existing car calls will be canceled.
- Retain status during power loss: If enabled, the car will retain its in-car CFSS status after recovering from a power loss.

CFSS Mode ‘n’ - Front / Rear Tabs • The CFSS Mode 1 and 2 > Front and Rear tabs determine how the front and rear doors will operate during CFSS operation. The parameters and descriptions are the same as those for EMS Switch 1 and 2 > Front and Rear tabs. [Please refer to “EMS Switch ‘n’ - Front / Rear Tabs” on page 9-67](#)

Car Operation - Flood Operation Tab

This tab allows the elevator to be configured for emergency operation during flood conditions.

Flood operation

Enable

Floor labels	Flood floors
12	
11	
10	
9	
8	
7	
6	
5	
M	
L	
B	<input checked="" type="checkbox"/>
SB	<input checked="" type="checkbox"/>

Fire fighters' service

In-car CFSS mode 1
If doors are open, after 20.0 sec

In-car CFSS mode 2
If doors are open, after 20.0 sec

Emergency medical service
If doors are open, after 20.0 sec

Independent service

Attendant service

Independent and Attendant service if doors are open, after 20.0 sec

Substitute recall floor during flood operation

Emergency power recall L

Fire recall floor L

Buttons: Select, Deselect, Send

Enable In areas where flood operation is not required, this option may be left unchecked. If enabled, the flood condition selections on the screen become active.

Flood Floors During flood operation, floors in danger of flooding shall be avoided. The topography and construction at each job site will determine which and how many floors are affected.

- Click in the Flood floors column, the floors that should not be serviced during flood operation. A check mark will appear next to each selected floor.

Flood Operation Shall Override Depending upon code requirements, flood operation interaction with other operating modes is user selectable. For the mode(s) of operation selected, where the requirements of Flood operation are not in agreement with those of the selected mode, the requirements of Flood operation will take precedence.

During Flood operation, cars shall avoid the flood zones. If inside the flood zones, cars shall proceed to the nearest floor outside the flood zone immediately unless the doors are open, in which case the timer (if any) must first elapse:

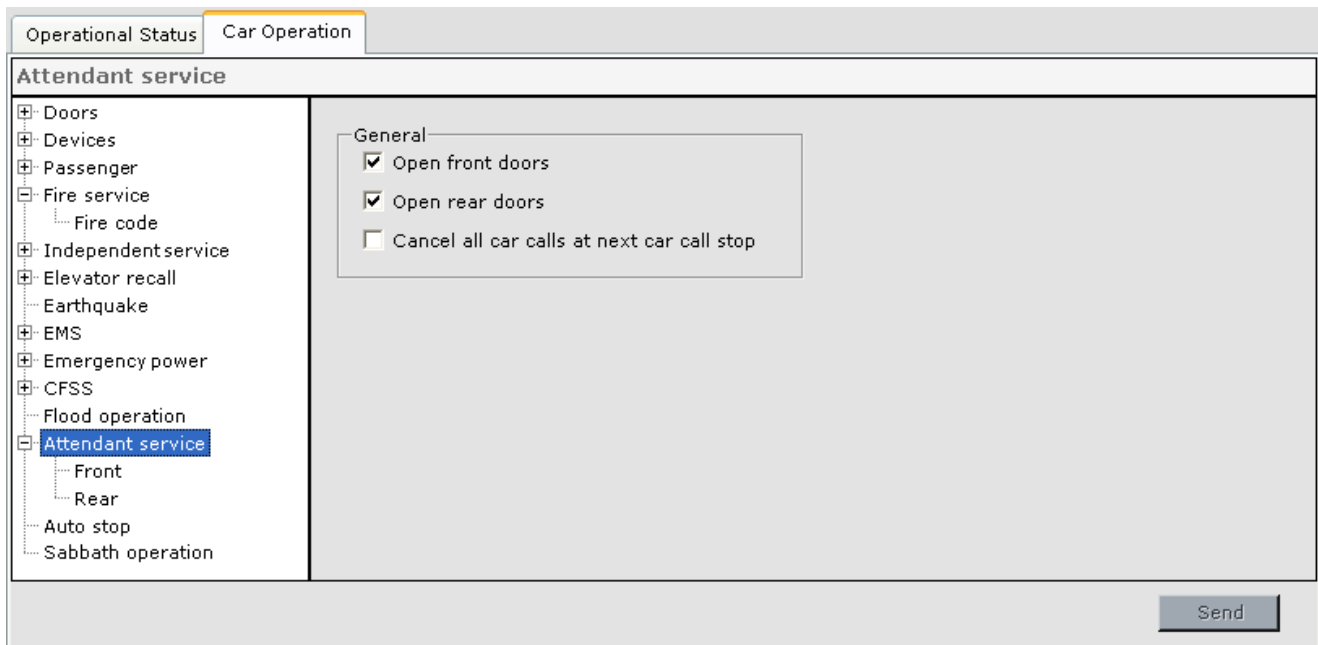
- Firefighters service: Select if flood operation requirements should override In-car firefighter operation requirements.
- In-car CFSS mode 1: Select if flood operation requirements should override In-car CFSS mode 1 requirements.
 - If doors are open, after (timer) sec. If the car is inside the flood zone and doors are open, this timer must elapse before the car proceeds to the nearest floor outside the flood zones.
- In-car CFSS mode 2: Select if flood operation requirements should override In-car CFSS mode 2 requirements.
 - If doors are open, after (timer) sec. If the car is inside the flood zone and doors are open, this timer must elapse before the car proceeds to the nearest floor outside the flood zones.
- Emergency medical service (EMS): Select if flood operation requirements should override the requirements of EMS service.
 - If doors are open, after (timer) sec. If the car is inside the flood zone and doors are open, this timer must elapse before the car proceeds to the nearest floor outside the flood zones.
- Independent Service: Select if flood operation requirements should override Independent and Service operation requirements.
- Attendant Service: Select if flood operation requirements should override Attendant Service operation requirements.
 - Independent and Attendant service if doors are open, after (timer) sec. If the car is inside the flood zone and doors are open, this timer must elapse before the car proceeds to the nearest floor outside the flood zones.

Substitute recall floor during flood operation Substitute floors can be designated for Emergency Power recall and Fire recall:

- Emergency Power recall: Select the recall floor the elevator is to use during emergency power operation under flood conditions.
- Fire recall floor: Select if flood operation should modify fire recall operation. If so, set the recall floor to be used if fire recall is activated during flood conditions.

Car Operation - Attendant Service Tab

Attendant Service allows a car to be diverted from passenger operation for use by an attendant.



The screenshot shows the 'Car Operation' tab with the 'Attendant service' sub-tab selected. The left-hand navigation pane lists various service categories, with 'Attendant service' highlighted. The main configuration area is titled 'Attendant service' and contains a 'General' section with the following options:

- Open front doors
- Open rear doors
- Cancel all car calls at next car call stop

A 'Send' button is located at the bottom right of the configuration area.

General These parameters specify which doors to open if both doors are closed when the car is placed on Attendant operation.

- **Open front doors:** If the doors are closed when a car call is placed on Attendant Service, the front doors shall be opened.
- **Open rear doors:** If the doors are closed when a car call is placed on Attendant Service, the rear doors shall be opened.
- **Cancel all car calls at next car call stop:** Specifies that all car calls be canceled after the elevator completes the first car call stop.

Attendant Service - Front / Rear Tabs The Front and Rear parameters determine how the front and rear doors will operate during Attendant Service Operation. The parameters and descriptions are the same as for the Independent Service > Front and Rear tabs. [Please refer to "Independent Service - Front / Rear Tabs" on page 9-59.](#)

Car Operation - Auto Stop Tab

If enabled and activated, Auto Stop will cause a car to stop at a selected floor and cycle its doors for observation before continuing on to its destination. The controls become enabled when “Enable” is checked. Set the configuration parameters and click Send to send those settings to the controller.

- **Enable:** Allows automatic stop controls to become active and “arms” the feature. The elevator will not actually begin obeying automatic stop settings until the Automatic Stop hardware input is activated, a timer is programmed or the Activate button and Send button are clicked.
- **General**
 - **Stop floor:** The floor at which the car should pause and cycle doors.
 - **Direction:** Determines if the car will pause when travelling up, down, or both.
 - **Door operation:** Determines whether front, rear, or both doors will cycle.
 - **Stop during Independent service:** Allows Automatic Stop to take effect during Independent service. Otherwise, a car on Independent service will not obey automatic stop.
 - **Stop during Attendant service:** Allows Automatic Stop to take effect during Attendant service. Otherwise, a car on Attendant service will not obey automatic stop.

- Door Dwell
 - Dwell time: The time, in seconds, that the door(s) will remain open before re-closing.
 - PHE cancels dwell timer: Allows photo eye detector activation to cancel remaining dwell time.
 - Car call button cancels dwell timer: Allows pressing a car call button to cancel remaining dwell time.
 - Door close button cancels dwell timer: Allows pressing the door close button to cancel remaining dwell time.
- Status
 - Auto stop ON: LED lights to indicate that Auto stop is On.
 - Activate button: Turns the Automatic stop function On or Off. The button caption changes to Deactivate when Auto stop is On:

**Note**

When Automatic Stop is enabled (“Enable” is checked), it may be turned On or Off using the following:

- A switch connected to the Automatic Stop hardware input.
- By clicking the Activate button and then clicking the Send button.
- By programming a Timer to turn Auto stop On or Off.

Car Operation - Sabbath Tab

These parameters determine how the car performs when on Sabbath operation. Sabbath operation must be Enabled via the “Enable Sabbath operation” parameter, and then Activated/Deactivated via a key switch-input, timer or software command from iMonitor or iView (Activate/Deactivate button on this tab). While performing Sabbath operation, the car automatically stops at predetermined floors, opens the doors for a period of time, then closes the doors and moves to the next designated Sabbath operation floor.

Sabbath operation

- Enable Sabbath operation
 - Allow hall call service
 - Allow car call service
 - Finish existing car calls
 - Disable car call buttons light
 - Disable position indicators
 - Disable load weighing functions
- Sabbath operation recall floor: <None>
- Sabbath operation start floor: Current up (bidirectional)
- Sabbath operation return floor: <None>
- Sabbath trip interval timer: 0 min
- Sabbath door open timer: 10 sec

Sabbath operation status: ●

	Front	Rear	
12			<input type="button" value="Select"/> <input type="button" value="Deselect"/>
11	✓		
10			
9	✓		
8			
7			
6			
5			
M			
L			
S			
SB	✓		

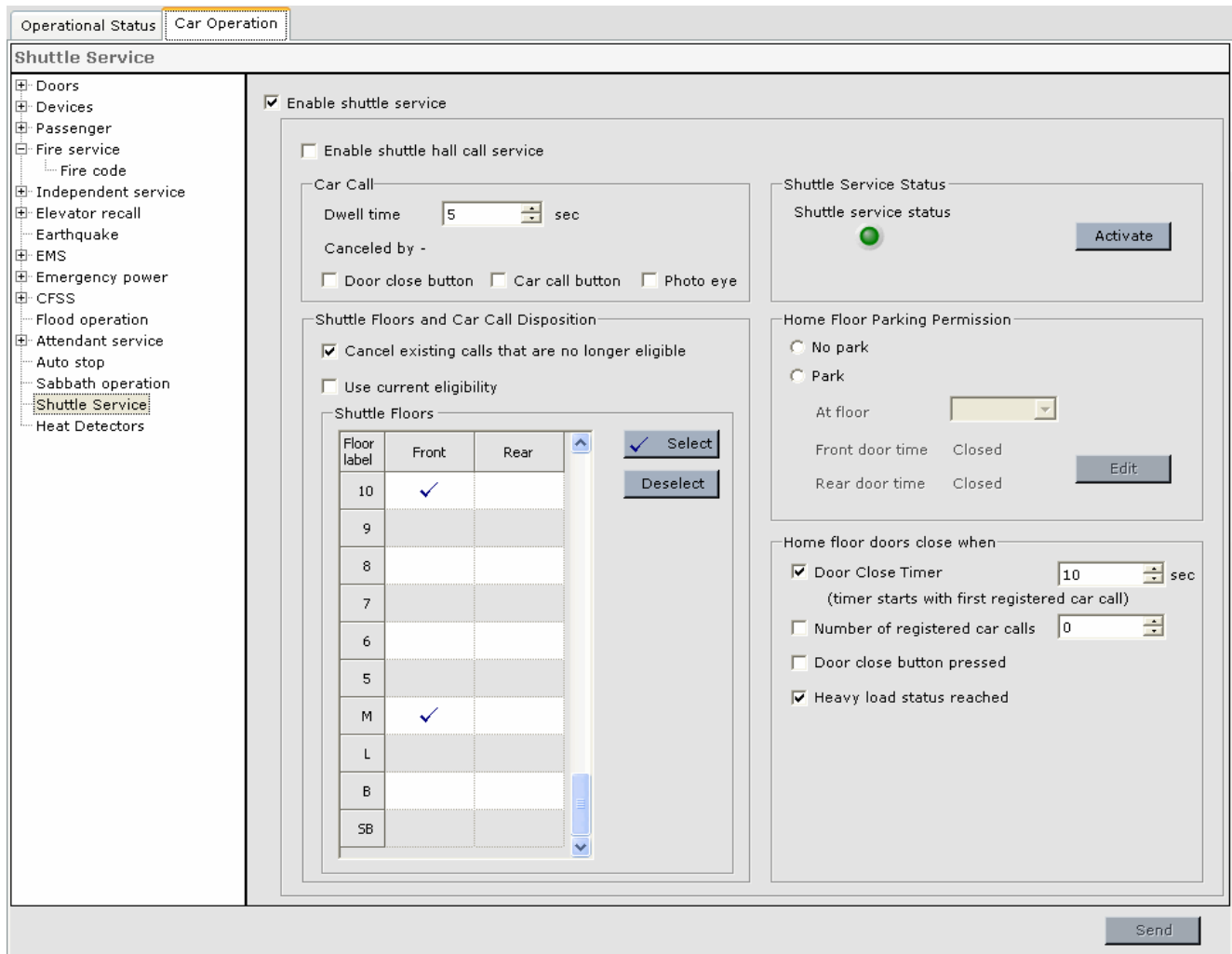
The programmable options for Sabbath operation include:

- **Enable Sabbath Operation:** Must be checked for Sabbath operation to be activated/deactivated. Otherwise Sabbath operation is disabled.
- **Allow hall call service:** Check to allow existing hall calls to be served and new hall calls to be registered while on Sabbath operation.
 - **Disable arrival lanterns:** During Sabbath operation the arrival lanterns shall be disabled (applies only if “Allow hall call service” is checked).
- **Allow car call service:** Check to allow existing car calls to be served and new car calls to be registered while on Sabbath operation.
- **Finish existing car calls:** When Sabbath operation is activated, the car will service all existing car calls before beginning Sabbath operation.
- **Disable car call buttons light:** The car call buttons will not illuminate in response to automatically generated Sabbath operation calls. However, they will illuminate to indicate registration of car calls in response to call button activation.
- **Disable position indicators:** During Sabbath operation the position and direction indicators shall be disabled (except for CE Electronics displays).
- **Disable load weighing functions:** During Sabbath operation the elevator's load weighing functions shall be disabled (except for pre-torquing).
- **Sabbath operation recall floor:** When Sabbath operation is activated, if a recall floor is designated, the car will first recall to this floor before beginning Sabbath operation service.
- **Sabbath operation start floor:** When Sabbath operation is activated, after traveling to the recall floor (if designated), the car will travel to the start floor (if designated) before beginning Sabbath operation service. The start floor options are:
 - **Bottom (unidirectional)** = Start at the bottom floor and travel up, stopping at designated Sabbath floors until the top designated floor is reached. What happens next is determined by the Sabbath trip interval timer and Sabbath operation return floor parameters.
 - **Top (unidirectional)** = start at the top floor and travel down, stopping at designated Sabbath floors until the bottom designated floor is reached. What happens next is determined by the Sabbath trip interval timer and Sabbath operation return floor parameters.
 - **Current up (bidirectional)** = start at the current floor and travel up (unless down preference exists, in which case travel down), stopping at designated Sabbath floors until the top/bottom designated floor is reached. Then, if all designated floors have not been served at least once, reverse direction, stopping at designated floors until the bottom/top designated floor is reached. What happens next is determined by the Sabbath trip interval timer and Sabbath operation return floor parameters.
 - **Current down (bidirectional)** = start at the current floor and travel down (unless up preference exists, in which case travel up), stopping at designated Sabbath floors until the bottom/top designated floor is reached. Then, if all designated floors have not been serviced at least once, reverse direction, stopping at designated floors until the top/bottom designated floor is reached. What happens next is determined by the Sabbath trip interval timer and Sabbath operation return floor parameters.
- **Sabbath operation return floor:** The car shall travel to the return floor (if specified) after it has finished servicing all of the Sabbath floors (at least once). Select None or any floor.

- **Sabbath trip interval timer:** Specifies the interval between Sabbath operation trips. During the time between trips, the car operates in Passenger mode. A value of Non-stop = continuous Sabbath operation.
- **Sabbath door open timer:** Specifies the amount of time the doors shall remain open at each floor during Sabbath operation.
- **Sabbath operation status LED:** LED lights green when Sabbath operation is activated.
- **Activate/Deactivate button:** Sabbath operation can be activated/deactivated using this button. When Sabbath operation has been activated, the button caption changes to “Deactivate”. Sabbath operation can also be activated/deactivated via a key switch-input, iMonitor command or a timer.
- **Sabbath Operation Floors:** Specifies the floors (front, rear or both openings) that are to be serviced during Sabbath operation.
 - To add or remove the check mark in an individual cell, click the cell.
 - To add or remove check marks from a group of cells, click and drag to select the cells, then click Select or Deselect.
 - To add or remove check marks from a whole column, click the column label, then click Select or Deselect.

Car Operation - Shuttle Service

The Shuttle service option allows the car to be used to provide express service for a subset of the building's floors. Shuttle service is available only during Passenger mode and is turned On/Off via a key-switch/input or software command (Activate/Deactivate button). A key-switch/input may also be used to immediately override Shuttle service.



The screenshot shows the 'Car Operation' tab in the iView interface. The 'Shuttle Service' section is active, displaying various configuration options. On the left, a tree view shows the navigation structure, with 'Shuttle Service' selected. The main configuration area includes:

- Enable shuttle service:** A checked checkbox.
- Enable shuttle hall call service:** An unchecked checkbox.
- Car Call:**
 - Dwell time: 5 sec (adjustable).
 - Canceled by:
 - Door close button (unchecked)
 - Car call button (unchecked)
 - Photo eye (unchecked)
- Shuttle Floors and Car Call Disposition:**
 - Cancel existing calls that are no longer eligible (checked)
 - Use current eligibility (unchecked)
 - Shuttle Floors:** A table for selecting eligible floors.

Floor label	Front	Rear
10	✓	
9		
8		
7		
6		
5		
M	✓	
L		
B		
SB		
- Shuttle Service Status:** A green indicator light and an 'Activate' button.
- Home Floor Parking Permission:**
 - No park (selected)
 - Park (unselected)
 - At floor: (dropdown menu)
 - Front door time: Closed
 - Rear door time: Closed
 - 'Edit' button
- Home floor doors close when:**
 - Door Close Timer (checked): 10 sec (timer starts with first registered car call)
 - Number of registered car calls (unchecked): 0
 - Door close button pressed (unchecked)
 - Heavy load status reached (checked)

A 'Send' button is located at the bottom right of the configuration area.

- **Enable shuttle service:** Indicates that the job has shuttle service and enables the shuttle service controls.
- **Enable shuttle hall call service:** Determines if hall call service is enabled while on Shuttle service.

Car Call

- **Dwell time:** Sets the door dwell time when the car is responding to a car call.
- **Canceled by -** Car call dwell time is canceled by any of the following that are checked.
 - **Door close button:** Activation of the door close button cancels car call dwell time.
 - **Car call button:** Activation of a car call button cancels car call dwell time.
 - **Photo eye:** Activation of the photo eye cancels car call dwell time.

Shuttle Service Status

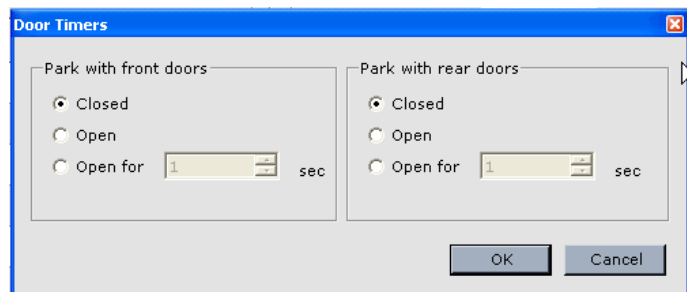
- **Shuttle service status LED:** LED is lighted when Shuttle service is On.
- **Activate / Deactivate button:** Software command used to turn Shuttle service On or Off.

Shuttle Floors and Car Call Disposition

- **Cancel existing calls that are no longer eligible:** Specifies that any calls that become ineligible as a result of switching to the Shuttle Floors eligibility map will be canceled.
- **Use current eligibility:** If enabled, Shuttle service will use the car call eligibilities specified in the active car call configuration. Otherwise the “Shuttle Floors” map determines car call eligibilities during Shuttle service operation.
- **Shuttle Floors:** Allows the user to create an alternate car call eligibility map to be used during Shuttle service operation.

Home Floor Parking Permission

- **No park:** If no demand exists after the car completes a Shuttle service call, the car will remain at the floor.
- **Park - At floor:** If no demand exists after the car completes a Shuttle service call, the car will proceed to the specified floor and park.
- **Front / Rear door time:** Use the “Edit” button to display the “Door Timers” dialog and specify the door behavior to be used when the car parks. The options are:
 - Closed
 - Open
 - Open for X seconds.



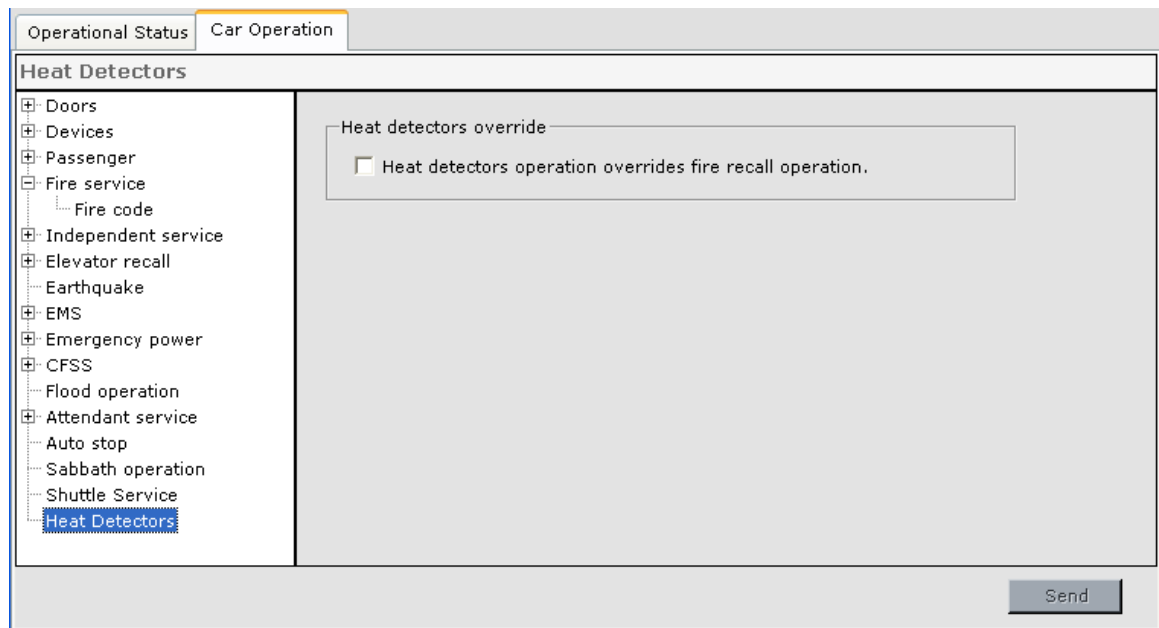
Home floor doors close when When the car is parked at the home floor, the doors are closed when the conditions of any of the following (that are checked) are met.

- **Door Close Timer:** The doors are closed when the door close timer expires. The timer starts when the first car call is registered.
- **Number of registered car calls:** The doors are closed when the number of registered car calls reaches this value.
- **Door close button pressed:** If calls are registered, momentary activation of the door close button causes the doors to close.
- **Heavy load status reached:** The doors are closed when the car reaches heavy load status.

Car Operation - Heat Detectors

This screen contains parameters that determine how the car will behave when one or more of the heat detectors are activated. Heat detectors can be installed in the machine room, in the hoistway, and/or on individual floors in the building. They are connected to inputs on an ICE-MIAC board. Outputs from an ICE-MOR board are used to control audible and visual alarms and well as to signal when heat detectors recall is complete.

- When heat detectors are activated, the fire warning light will flash until all heat detectors have been reset. The fire-warning buzzer will sound until the car is shutdown at a floor. A car that is parked at a floor will open its doors and shut down. A car in motion will proceed in the current direction to the next available floor where the heat detector is not tripped. If all heat detectors in the current direction are tripped, the car will reverse direction and proceed to the first floor where the heat detector is not tripped. If again all heat detectors are tripped, the car will proceed to the main fire recall floor unless the car is also on Fire Service, in which case the car will proceed to the appropriate fire recall floor. Once the car is stopped at a floor it will automatically open its doors and shut down. Then, if the machine room or hoistway heat detectors are active, a signal is provided to disconnect the main power line and/or activate the sprinklers where available.



- **Heat detectors operation overrides fire recall operation:** If checked, heat detectors operation will override fire recall operation even if fire recall is already in progress when the heat detector(s) are activated. If not checked, fire recall operation will take precedence unless heat detectors operation is already in progress or has completed and the car has been shut down when fire service is activated.

Configuration - Drive

The Drive Configuration tab allows you to set and view user adjustable drive parameters.

Tabs are selectable for parameters including:

- **General:** Drive type, speed reference, system values, pre-start sequence (see page 9-88).
- **Safety:** Safety related settings (see page 9-90).
- **Control:** Not applicable to iControl AC.
- **Filters:** Filter frequency settings (see page 9-91).
- **Dampening:** Not applicable to iControl AC.
- **Pre-Torque:** Pre-torque settings where appropriate (see page 9-92).
- **Calibration:** Drive calibration procedure initiation (see page 9-93).

Drive - General Tab

Options General drive setup:

- Drive type: Select the drive used in this controller.
- Drive interface: Select Analog or Serial.
- Motor blower hold delay: The motor blower is relay driven and shuts down when the motor stops. This timer allows you to delay blower shutdown so that the motor may receive additional cooling or so that the blower is not constantly power-cycled when the motor is stopping for only a brief period.

Pre-Start Sequence These parameters define the conditions under which the machine may be energized and/or the brake lifted prior to the default “After doors are locked” state. **Warning! Do not use Pre-Start Sequence options until drive control parameters have been adjusted for no rollback and good control at zero speed.**

- Allow machine to be energized: Defines the state of the doors required before the machine is allowed to be energized:
 - After doors are locked: Doors must be locked before the machine may be energized (the motor is energized and brake is fully picked). Any soft lift brake adjustment is applied.
 - After door position monitor is activated: The door position monitor or doors locked sensors must be activated before the machine may be energized (the motor is energized and brake is fully picked). If this option is selected, but the job doesn't have a door position monitor, the machine is energized when the doors are locked. Any soft lift brake adjustment is applied.
 - While door are closing: Doors must be closing, then the machine may be energized as follows:
 - with motor and fully picked brake: The motor is energized and the brake is fully picked. Any soft lift brake adjustment is applied.
 - with motor and partially picked brake: The motor is energized and brake is partially picked. The Speed pick delay 1 must expire and the doors must be locked before the brake is fully picked. After the brake is fully picked, Speed pick delay 2 must expire before the elevator is allowed to move. No soft lift brake adjustment is applied.
 - with motor only: The motor is energized after the prescribed delay from doors closing. After the doors lock, the brake is fully picked, and Speed pick delay 1 must expire before the elevator is allowed to move. Any soft pick brake adjustment is applied.
 - Pre-Start Sequence Delay: After the doors have begun to close, wait the specified time before energizing the machine as defined as defined in “While doors are closing”.



Note

Regardless of the selection above, the elevator is not allowed to move away from the landing until the doors are locked and the Speed pick delay 1 timer has elapsed.

Speed Reference More detailed settings related to the speed reference mechanism. Please refer to “Calibrating Actual Car Speed” on page 2-57.

- Reference type: Tachometer, Encoder, Internal or Serial.
- Resolution: This parameter affects elevator speed only for an encoder configuration. Increasing this parameter will increase car speed.
- Rotational coupling ratio: This parameter affects elevator speed only for an encoder configuration. Increasing this parameter will increase car speed. If the encoder is shaft mounted, this is normally set to 1. If the encoder is sheave or brake drum mounted, this value must be calculated:

$$\text{Coupling Rotational Ratio} = \frac{\text{Motor Rated RPM} \times \text{Sheave (Brake) Diameter}}{\text{Encoder Follower Wheel Diameter}}$$

OR

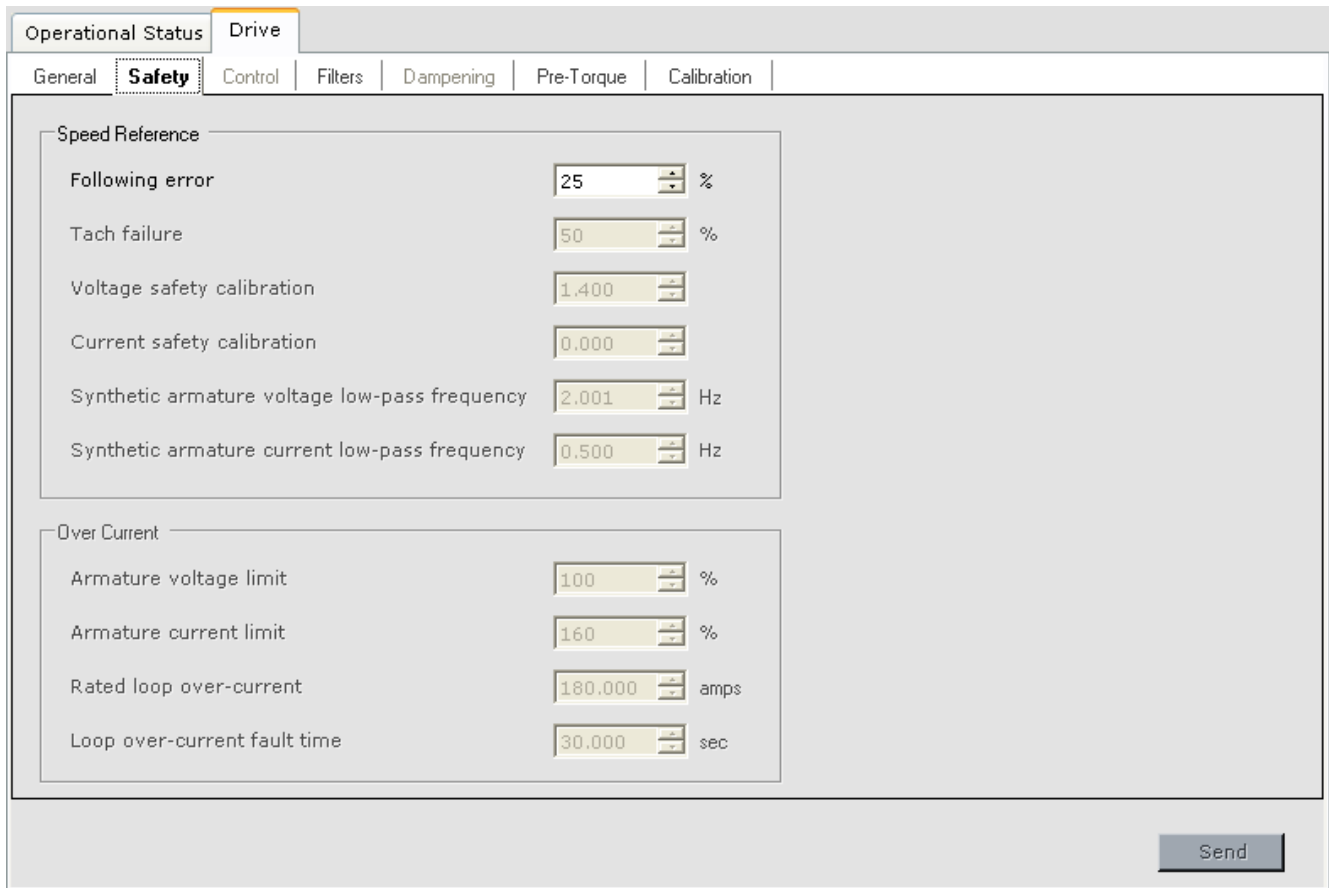
$$\text{Coupling Rotational Ratio} = \frac{\text{Brake Drum Circumference}}{\text{Encoder Follower Wheel Circumference}}$$

- Rated motor RPM: This parameter affects elevator speed for an encoder or serial configuration. Increasing this parameter will increase car speed.
- Rotational direction: Sets the encoder pulse stream order recognized by the controller as indicating up or down travel. This parameter is used by all configurations except Internal.
- Scaling: This parameter affects elevator speed only for a tachometer configuration. Increasing this parameter will reduce car speed.
- Current safety calibration: Not applicable to iControl AC.
- Voltage safety calibration: Not applicable to iControl AC.

System

- Rated line voltage: Line voltage being supplied to the drive.
- Drive header voltage: Not applicable to iControl AC.
- Drive header current: Not applicable to iControl AC.
- Normal rate limited stop: Determines the deceleration from leveling/releveling to zero speed when the elevator stops normally at a floor. Please refer to “Final Adjustment Before Running at Contract Speed” on page 4-7.
- Emergency rate limited stop: Determines the deceleration from this speed at this instant to zero speed when the elevator makes an emergency stop.

Drive - Safety Tab



The screenshot shows the 'Drive - Safety' configuration tab in the iView software. The interface includes a top navigation bar with 'Operational Status' and 'Drive' tabs. Below this is a sub-menu with 'General', 'Safety', 'Control', 'Filters', 'Dampening', 'Pre-Torque', and 'Calibration'. The 'Safety' tab is active, displaying two main sections: 'Speed Reference' and 'Over Current'. Each section contains several parameters with numerical input fields and units.

Section	Parameter	Value	Unit
Speed Reference	Following error	25	%
	Tach failure	50	%
	Voltage safety calibration	1.400	
	Current safety calibration	0.000	
	Synthetic armature voltage low-pass frequency	2.001	Hz
	Synthetic armature current low-pass frequency	0.500	Hz
Over Current	Armature voltage limit	100	%
	Armature current limit	160	%
	Rated loop over-current	180.000	amps
	Loop over-current fault time	30.000	sec

A 'Send' button is located at the bottom right of the configuration area.

Speed Reference

- **Following error:** Adjusts amount of error permitted between voltage from Tach/Encoder and pattern voltage. When set to 75%, a 7.5VDC error is allowed between the Tach/Encoder and pattern voltages (100% = 10VDC). If excessive error is detected, a Tach Error Fault will be displayed. [Please refer to "Following Error Margin" on page 2-58.](#)

Drive - Filters Tab

System filters are used to smooth oscillation or resonance in a signal. Oscillation can almost always be corrected by adjusting the TORQMAX drive and should always be adjusted before filtering defaults are changed. The notch filter is used to block a specific, fixed/narrow frequency oscillation, induced by the mechanical system and reflected in the speed feedback signal.



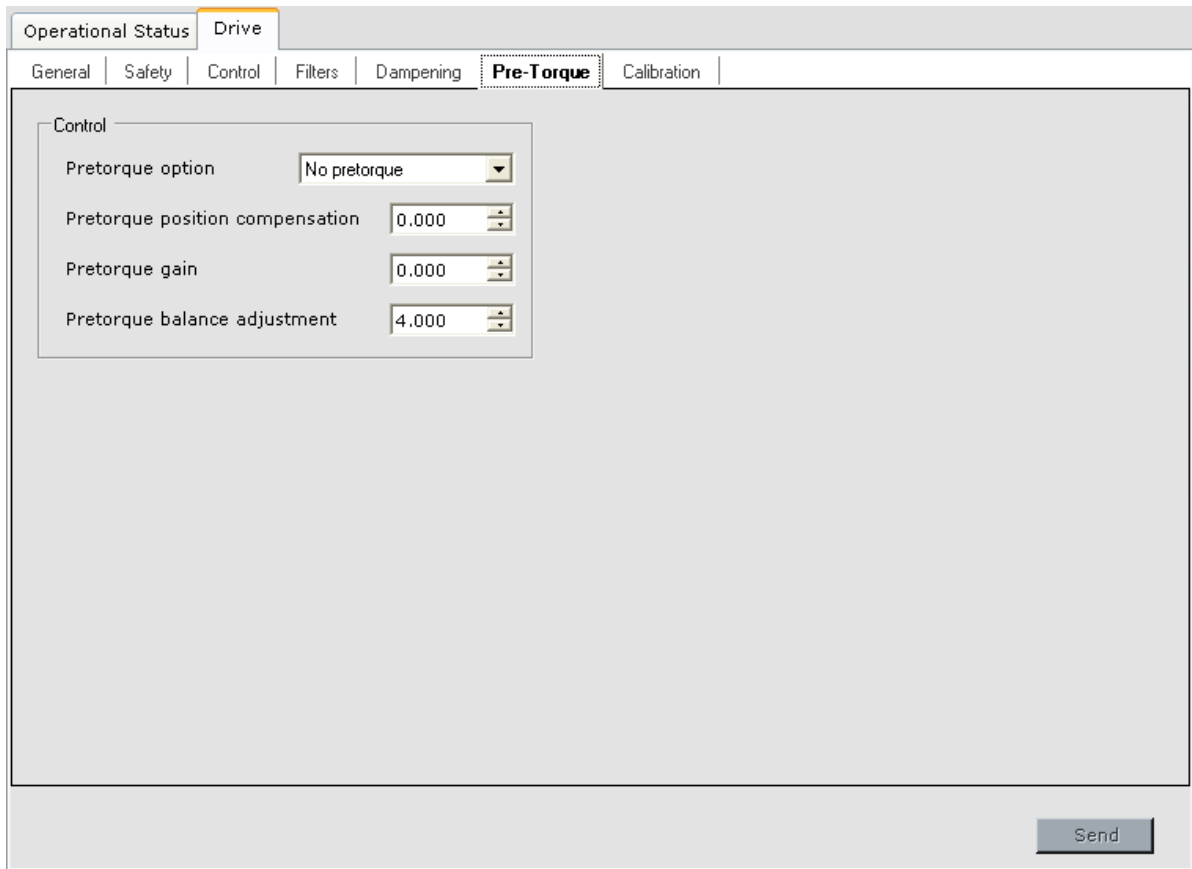
Caution

Incorrect filter settings may result in oscillation (not enough high frequency filtering) or in unresponsive, erratic control of car speed (too much high frequency filtering). Consult MCE Technical Support if you are not familiar with adjusting filters. Always work with TORQMAX drive before changing filter default settings.

System Speed loop filtering.

- Raw pattern frequency: Applies smoothing to the raw pattern frequency. Higher settings provide better response but may result in uneven (bumpy) acceleration/deceleration.
- Flare pattern frequency: Applies smoothing to the flare pattern frequency. Higher settings provide better response but may result in uneven (bumpy) acceleration/deceleration.
- Processed pattern frequency: Applies smoothing to the post-processing pattern signal. Higher settings provide better response but may result in uneven (bumpy) acceleration/deceleration.
- Speed reference frequency: Smooths the Tach/Encoder signal. Typical recommended range is from 50 to 75 Hz. Higher values provide less smoothing.

Drive - Pretorque Tab



The screenshot displays the 'Drive - Pretorque' configuration window. It features a tabbed interface with 'Operational Status' and 'Drive' tabs. Under the 'Drive' tab, there are sub-tabs for 'General', 'Safety', 'Control', 'Filters', 'Dampening', 'Pre-Torque', and 'Calibration'. The 'Pre-Torque' sub-tab is active, showing a 'Control' section with the following settings:

Parameter	Value
Pretorque option	No pretorque
Pretorque position compensation	0.000
Pretorque gain	0.000
Pretorque balance adjustment	4.000

A 'Send' button is located at the bottom right of the window.

Control Both isolated platform and strain gauge load weighing devices are supported. Please refer to “Pre-torque Adjustments” on page 4-16.

- Pretorque option: The following Pretorque options are available:
 - No Pretorque: Pretorque is disabled.
 - Synthetic pretorque: Pretorque is enabled with a fixed load value which is equal to a *Pretorque balance adjustment* value of four (4). When a load weigher is not available, this option can be used to improve initial start by helping to hold the car at zero speed when the brake is first lifted. Adjust the *Pretorque balance adjustment* up or down from four (4) to get positive or negative pretorque, and adjust the *Pretorque position compensation* and *Pretorque gain* as desired.
 - Load weigher pretorque: Pretorque is enabled. The load value is supplied by an analog load weigher.
- Pretorque position compensation: Controls the pretorque output voltage based on car position in the hoistway.
- Pretorque gain: Controls the amount of output voltage from the pre-torque function. Increase to increase voltage at takeoff and compensate for any rollback at the start of a run.
- Pretorque balance adjustment: Adjust to ensure no rollback of a balanced car at the top of the hoistway.

Drive - Calibration Tab

The screenshot displays the 'Drive - Calibration Tab' interface. It features a main 'Drive' tab and several sub-tabs: 'General', 'Safety', 'Control', 'Filters', 'Dampening', 'Pre-Torque', and 'Calibration'. The 'Calibration' sub-tab is selected, showing two main sections: 'Offsets' and 'Input ADC'. Each section contains a list of parameters with corresponding numerical input fields and up/down arrows.

Section	Parameter	Value
Offsets	Current loop integral	1.000
	Current sensor	1.000
	Zero crossing	0.000
	Output DAC	0.000
Input ADC	Tachometer	0.000
	Brake current	0.000
	Brake voltage	0.000
	Motor field weakening	0.000
	Armature current	0.000
	Armature voltage	0.000
	Absolute armature current	0.000
	Motor field current	0.000
	Motor field voltage	0.000
	AC phase A current	0.000
	AC phase B current	0.000
	AC phase C current	0.000

A 'Send' button is located at the bottom right of the interface.

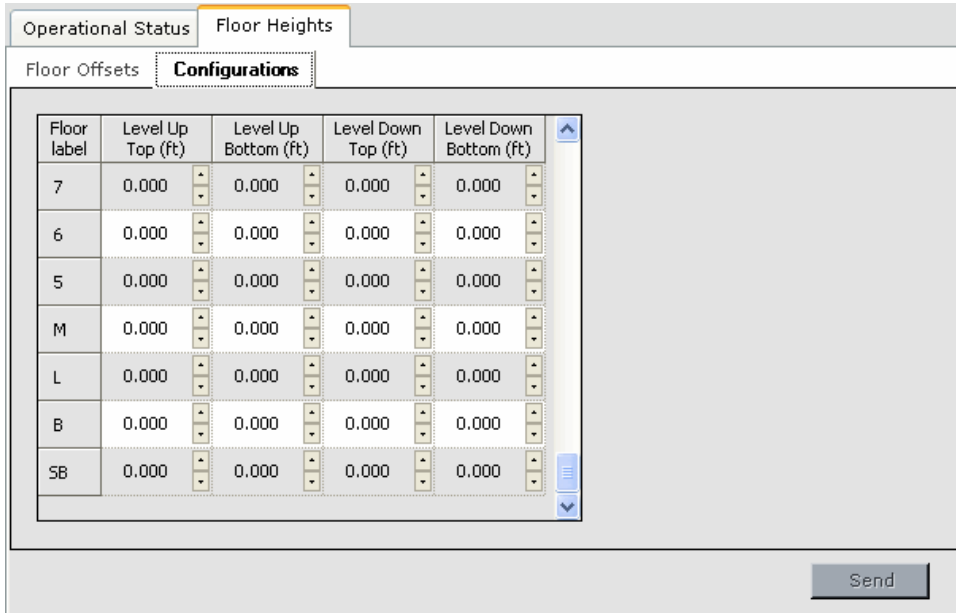
Offsets

For various functions the iBox converts voltages from analog to digital or from digital to analog. ADC and DAC adjustments allow you to compensate for any conversion offset that might occur.

- **Output DAC:** Compensates for slight differences that might exist between zero speed commanded by the pattern and 0.0 volts appearing between the iBox and the drive input.
- **Input ADC:** Compensates for slight differences that might exist between the analog input voltage and the resulting value after the iBox converts that value to a digital equivalent for internal processing. The Input ADC offset values are determined when the drive setup procedure is performed. [Please refer to "Drive Offsets Calibration" on page 2-48.](#)

Configuration - Floor Heights

The Configuration > Floor Heights > Configurations tab is used to view the learned values for the floor heights.

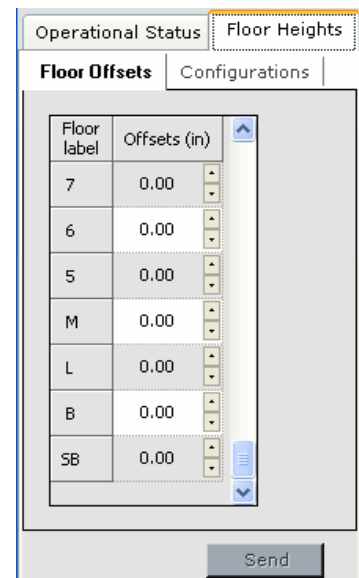


Floor label	Level Up Top (ft)	Level Up Bottom (ft)	Level Down Top (ft)	Level Down Bottom (ft)
7	0.000	0.000	0.000	0.000
6	0.000	0.000	0.000	0.000
5	0.000	0.000	0.000	0.000
M	0.000	0.000	0.000	0.000
L	0.000	0.000	0.000	0.000
B	0.000	0.000	0.000	0.000
SB	0.000	0.000	0.000	0.000

- **Level Up Top:** The learned distance from the bottom floor to the top of the floor magnet as determined by the Level Up sensor.
- **Level Up Bottom:** The learned distance from the bottom floor to the bottom of the floor magnet as determined by the Level Up sensor.
- **Level Down Top:** The learned distance from the bottom floor to the top of the floor magnet determined by the Level Down sensor.
- **Level Down Bottom:** The learned distance from the bottom floor to the bottom of the floor magnet determined by the Level Down sensor.

Floor Offsets Tab

- **Offsets:** The variance from the floor magnet position to the actual floor level position. The offset value is determined by performing the floor offset calibration procedure (Setup > Floor Heights > Floor Offsets). [Please refer to “Calibrating the Floor Offsets” on page 4-23.](#)



Floor label	Offsets (in)
7	0.00
6	0.00
5	0.00
M	0.00
L	0.00
B	0.00
SB	0.00

Configuration - General

The Configuration > General tab supports general building parameters. The tabs include:

- **General:** Car label, Car identifier and Simplex car parameters.
- **Floor Data:** Floor specific data including openings, false floors, door boost ([see page 9-96](#)).
- **Car Call Eligibility:** Car call permission/restriction for each opening ([see page 9-97](#)).

The screenshot shows a web-based configuration interface. At the top, there are two tabs: 'Operational Status' and 'General'. The 'General' tab is active. Below this, there are three sub-tabs: 'General', 'Floor data', and 'Car call eligibility'. The 'General' sub-tab is selected. The main content area is titled 'Controller Information' and contains the following fields:

- Car label:** A text input field containing the value '1'.
- Car identifier:** A dropdown menu with '1' selected.
- Group identifier:** A dropdown menu with '1' selected.
- Simplex car:** A checkbox that is currently unchecked.

At the bottom right of the form, there is a 'Send' button.

General Tab

- **Car label:** Assigned by building management.
- **Car identifier:** Used by the *iCUE* Central or Local Dispatcher for communication with the car in group systems. Set from 1 to 20.
Caution! The car identifier must be unique for every car within a group of elevators (no to cars assigned the same car identifier).
- **Group identifier:** Determines the IP address for communication with the *iCue* Group dispatcher. Addresses other than 1 are reserved for future use.
- **Simplex car:** This car is not part of a group.

General - Floor Data Tab

Floor data settings provide information about floor openings, floor labels, and door boost.

Operational Status **General**

General **Floor data** Car call eligibility

Settings

Floor	Floor label	Front opening	Rear opening	False floor	Front door boost	Rear door boost
14	14	✓	✓			
13	13	✓	✓			
12	12	✓	✓			
11	11	✓	✓			
10	10	✓	✓			
9	9	✓	✓			
8	8	✓	✓			
7	7	✓	✓			
6	6	✓	✓			
5	5	✓	✓			
4	M	✓	✓			
3	L	✓	✓			
2	B	✓	✓			
1	SB	✓	✓			

Select
 Deselect

Send

Note

Rather than proceeding floor-by-floor, column-by-column, you may choose to select a column head or multiple cells and use the “system wide” Select/Deselect controls to set all floors the same for that topic (where appropriate). You can also move from field to field using the Tab key.

Floor Data Settings For each floor:

- **Floor:** This is the floor number.
- **Floor label:** (Read only) The floor label is set on the System > Building tab.
- **False Floor:** Indicate whether or not this is a false floor (no openings).
- **Front/Rear Opening:** Indicate whether the car has front and/or rear opening doors. A check mark indicates the opening is available.
- **Door Boost Front/Rear:** Enable/Disable Door Boost to compensate for heavy doors or wind loading at a particular location.

General - Car Call Eligibility Tab

This tab allows you to create up to eight car call eligibility configurations. Each configuration, when active, determines whether car calls can be registered at any given side of an eligible floor. If no side is selected, car calls for that floor are disabled.

Any of the eight car call eligibility configurations may be manually selected as the “Active configuration” via its respective key-switch input or by selecting it using the software Configuration Settings on this screen. The Passenger service configuration setting is the software selection for all modes of operation except when the car is operating in one of the other modes listed under Configuration Settings, e.g. Independent or Attendant service. A key-switch selection overrides a software selection.

Operational Status | General

General | Floor data | **Car call eligibility**

Eligibility

Select configuration 1

Cancel existing calls that are no longer eligible

Floor label	Front	Rear
11	✓	✓
10	✓	✓
9	✓	✓
8	✓	✓
7	✓	✓
6	✓	✓
5	✓	✓
M	✓	✓
L	✓	✓
B	✓	✓
SB	✓	✓

Configuration Settings

Active configuration 1

Passenger service 1

Independent service 1

Attendant service 1

CFSS 1 service 1

CFSS 2 service 1

Swing operation 1

Sequential step scan car calls

Front inputs scan front and rear car call buttons

Send

Eligibility The table displays the current eligibility settings for the eligibility configuration selected by the Select configuration control.

- **Select configuration:** Select a configuration (1 through 8) to edit. As soon as a configuration is selected, the Eligibility table will update to show the current settings for that configuration.
- **Cancel existing car calls that are no longer eligible:** For the configuration selected, enable this setting if existing car calls that would become ineligible when this configuration is made active, should be immediately canceled. If this option is not enabled, existing car calls will be serviced.

To configure an eligibility configuration:

1. Select the desired configuration. Note that the table updates accordingly.
2. On a per-floor basis, enable (check) or disable (no check) front and/or rear car calls to that floor.
3. When the configuration is complete, click Send to store the changes on the iControl.

Eligibility

Select configuration 1

Cancel existing calls that are no longer eligible

Floor label	Front	Rear
11	<input checked="" type="checkbox"/>	<input checked="" type="checkbox"/>
10	<input checked="" type="checkbox"/>	<input checked="" type="checkbox"/>
9	<input checked="" type="checkbox"/>	<input checked="" type="checkbox"/>
8	<input checked="" type="checkbox"/>	<input checked="" type="checkbox"/>
7	<input checked="" type="checkbox"/>	<input checked="" type="checkbox"/>
6	<input checked="" type="checkbox"/>	<input checked="" type="checkbox"/>
5	<input checked="" type="checkbox"/>	<input checked="" type="checkbox"/>
M	<input checked="" type="checkbox"/>	<input checked="" type="checkbox"/>
L	<input checked="" type="checkbox"/>	<input checked="" type="checkbox"/>
B	<input checked="" type="checkbox"/>	<input checked="" type="checkbox"/>
SB	<input checked="" type="checkbox"/>	<input checked="" type="checkbox"/>

Select
Deselect

System wide operations: For high- or mid-rise buildings, use the system wide controls to speed the configuration process:

1. Click on the Front or Rear column header

Front	Rear
-------	------

.
2. Click Select or Deselect.

Alternatively, you may drag through a number of floors below the column header, then use the Select or Deselect control to set all highlighted floors.

Note

The “existence” of front and/or rear openings is determined by your selections on the preceding, Floor Data tab. If an opening is not recognized to exist, it will not be selectable.

Configuration Settings These controls allow you to select the active or default car call eligibility configuration and to select the same configuration or any of the other configurations to be active if one of the following special operating modes is activated.

The screenshot shows a window titled "Configuration Settings" with the following fields:

- Active configuration: 1
- Passenger service: 1
- Independent service: 1
- Attendant service: 1
- CFSS 1 service: 1
- CFSS 2 service: 1
- Swing operation: 1

- **Active configuration:** Indicates which car call eligibility configuration is currently active.
- **Passenger service:** This is the car call eligibility configuration which will be used when the car is on Passenger service or any mode of operation other than the ones listed below, e.g. Independent service, Attendant service, etc. Make any car call eligibility configuration active by selecting it here and clicking Send. (The active configuration display will update unless the car is on one of the modes of operation listed below.)
- **Independent service:** If the car should enter Independent service, the car call eligibility set selected here will be in control.
- **Attendant service:** If the car should enter Attendant service, the car call eligibility set selected here will be in control.
- **CFSS1 service:** If the car should enter Commandeer For Special Service (mode 1), the car call eligibility set selected here will be in control.
- **CFSS2 service:** If the car should enter Commandeer For Special Service (mode 2), the car call eligibility set selected here will be in control.
- **Swing operation:** If the car should enter Swing operation, the car call eligibility set selected here will be in control.

Sequential step scan car calls This option allows compliance with the ICC/ANSI A117.1-2003 requirement to accommodate passengers who are short or are using a wheel chair in buildings where the car control buttons are more than 48 inches above the floor. Scan Up and Scan Down buttons are used. When “Scan Up” is pressed, the car call buttons above the current floor are scanned. When “Scan Down” is pressed, the car call buttons below the current floor are scanned. When the button is released for more than 2 seconds, a call is registered for the last floor selected. This option is enabled when the Sequential Step Scan inputs are programmed (see “[Configuration - I/O Boards](#)” on page 9-100).

- **Front inputs scan front and rear car call buttons:** This option allows a single Scan Up and Scan Down button to be used to scan both front and rear car call buttons.

Configuration - I/O Boards



Caution

The input/output structure of your system was collected during the MCE field survey. This controller and cartop box are structured as shown in your job prints to reflect survey information. By incorrectly assigning inputs and/or outputs, you may disable parts of your system. Be certain that you understand what changes need to be made before beginning. Contact MCE Technical Support for information. **IN NORMAL INSTALLATIONS, YOU WILL NOT NEED TO ASSIGN INPUTS AND OUTPUTS. THEY WILL ALREADY BE ASSIGNED AS SHOWN ON YOUR JOB PRINTS.**

The circuit board complement of the iController (IMP), iLink (CTP) and Serial Car Operating Panel (COP 1 - 4) can be changed if required. When boards are added or connections are changed, this tab allows you to reassigned inputs and outputs accordingly.

IMP / CTP In the window shown below (Configuration > I/O Boards > Configuration tab), a Multiple Input AC (ICE-MIAC) board connected to the iBox Main Processor (ICE-IMP) board is selected for editing. When the edit button is clicked, the Terminal Configuration (IMP - MIAC) dialog, shown on the following page, is displayed.

Using the I/O Board Configuration Tab This tab is used to program I/O Board inputs and outputs, should you desire to make changes.

To add a board:

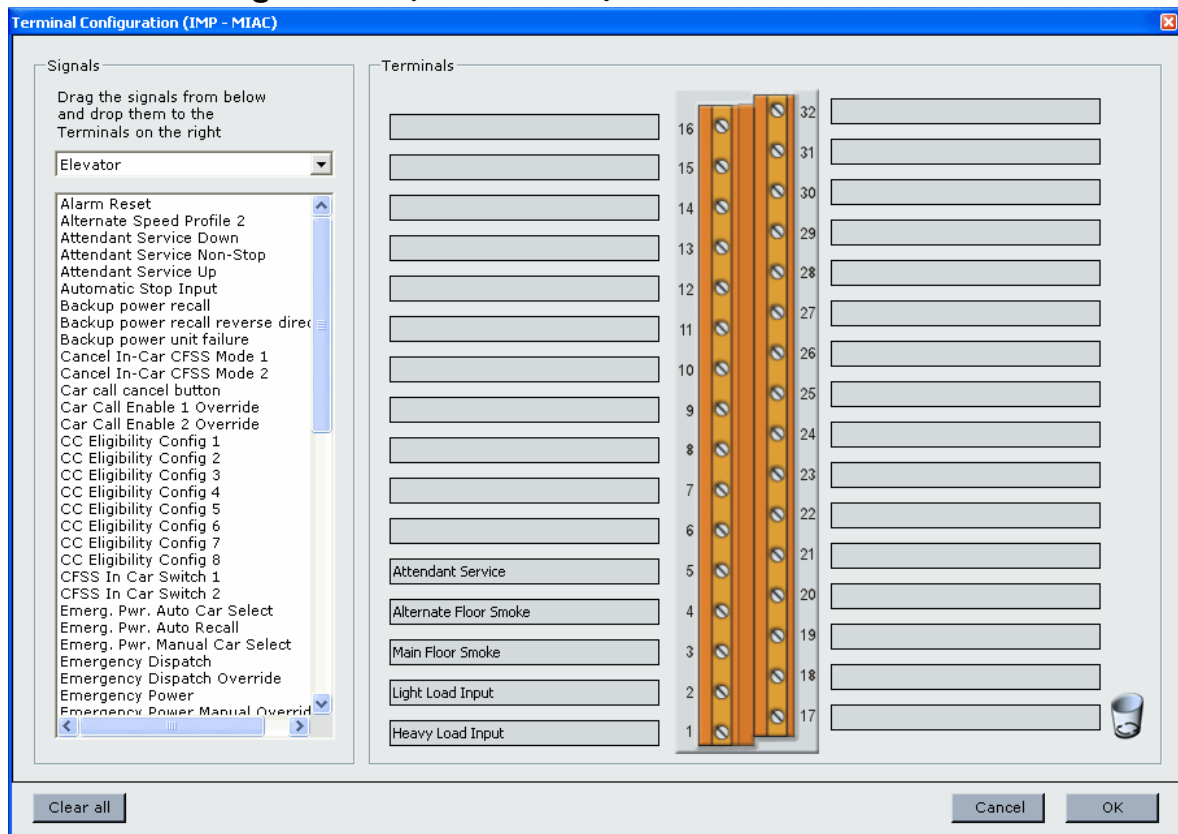
1. Select IMP / CTP or COP 1 - 4. **Note:** COP4 is not available on Cartop software version 1.1.15 of greater.
2. Locate the board in the *Boards* box on the right of the Configuration tab.
3. Drag the board into the ICE-IMP (iControl), ICE-CTP (iLink cartop box) or COP 1 - 4 (Car Operating Panel) enclosure as appropriate. Release the mouse button.
4. To rearrange a board along the bus representation, highlight it and click on the associated up/down controls. The board will move accordingly.
5. To remove a board, select and click Delete.

To change the input or output to/from a board connection:

1. Click to select the desired board and click Edit.
2. Select a signal group from the drop down list in the Signals box.
3. Select a signal from the list and drag it to the desired pin in the Terminals box.
4. To remove a signal from a pin, drag it into the trash or right click and then click Remove signal. To remove all signal assignments, click the *Clear all* button.
5. Click OK to approve your configuration.
6. Click Send to send your changes to the controller.
7. Or, click Cancel to close the dialog without saving any changes.

Each input or output may be assigned to only a single terminal.

Terminal Configuration (IMP - MIAC)

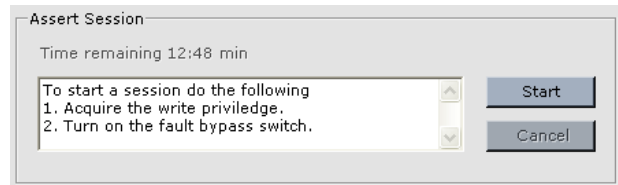




I/O Assert The I/O Assert feature allows the user to bypass the current state of a terminal on an IO board and assert a desired state (on or off) via iView. This can be used for troubleshooting and/or testing. Currently this feature is available for ICE-MIAC Multiple Input AC boards, ICE-MOR Multiple Output Relay boards and ICE-COP Serial Car Operating Panel boards both in the iController (connected to the ICE-IMP board) and on the cartop (connected to the ICE-CTP board).

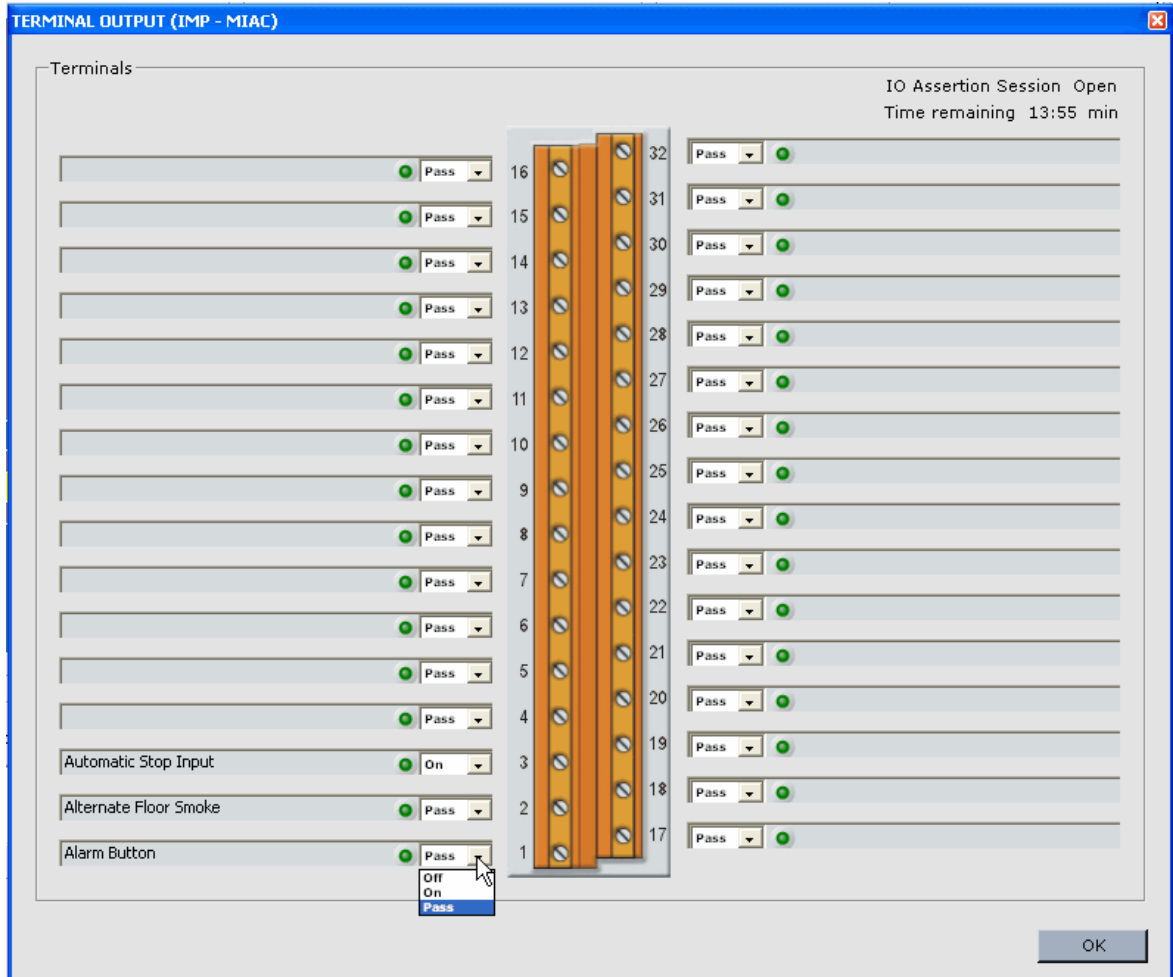
To use IO Assertion:

1. Acquire write privilege (select Acquire from the iView Write privilege menu).
2. Set the iBox FAULT/FUNCTION BYPASS switch to ON.
3. Click the Assert Session *Start* button (Configuration > I/O Boards > Configuration tab). The assert session begins and a 15 minute timer begins counting down the time remaining for this session.



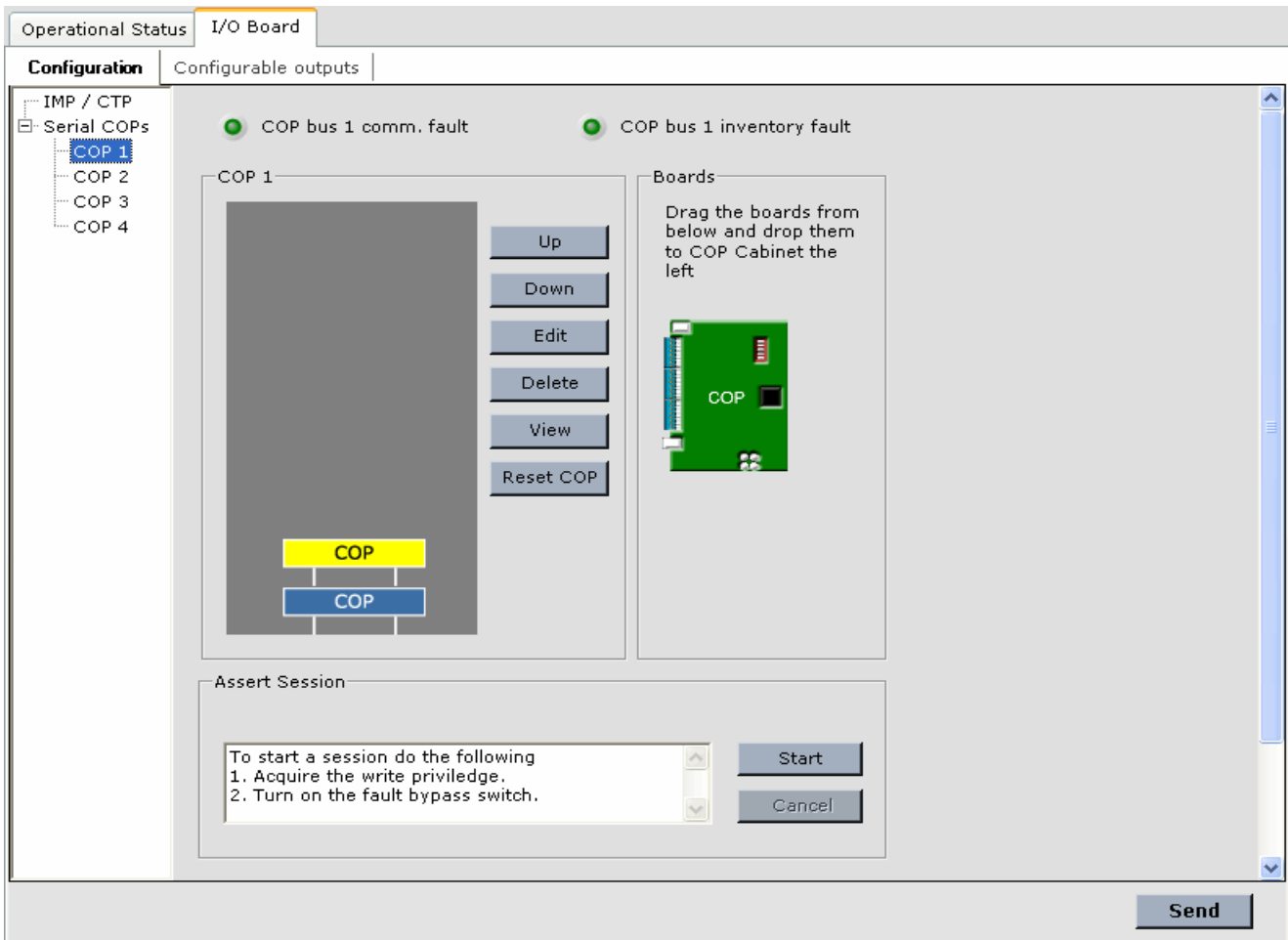
4. Select an I/O board (Configuration > I/O Board > Configuration tab) and click *View*. Notice that the state for all terminals, shown in the drop down list next to the indicator LED, is *Pass*, meaning that the current (default) state of the terminals is *not bypassed*.

Terminal Output dialog (view terminal status and set I/O assertions)



5. For the desired terminal, select On or Off from the drop down list next to the indicator LED to bypass the current state and assert the desired state.
6. You may set the state for additional terminals on this board or select a different board on which to set terminal assertions.
7. The Assert Session will end when one of the following occurs; the timer elapses, the FAULT/FUNCTION BYPASS switch is set to OFF or the Assert Session *Cancel* button is clicked. When the session has ended, all I/O are returned to the default *Pass* state.

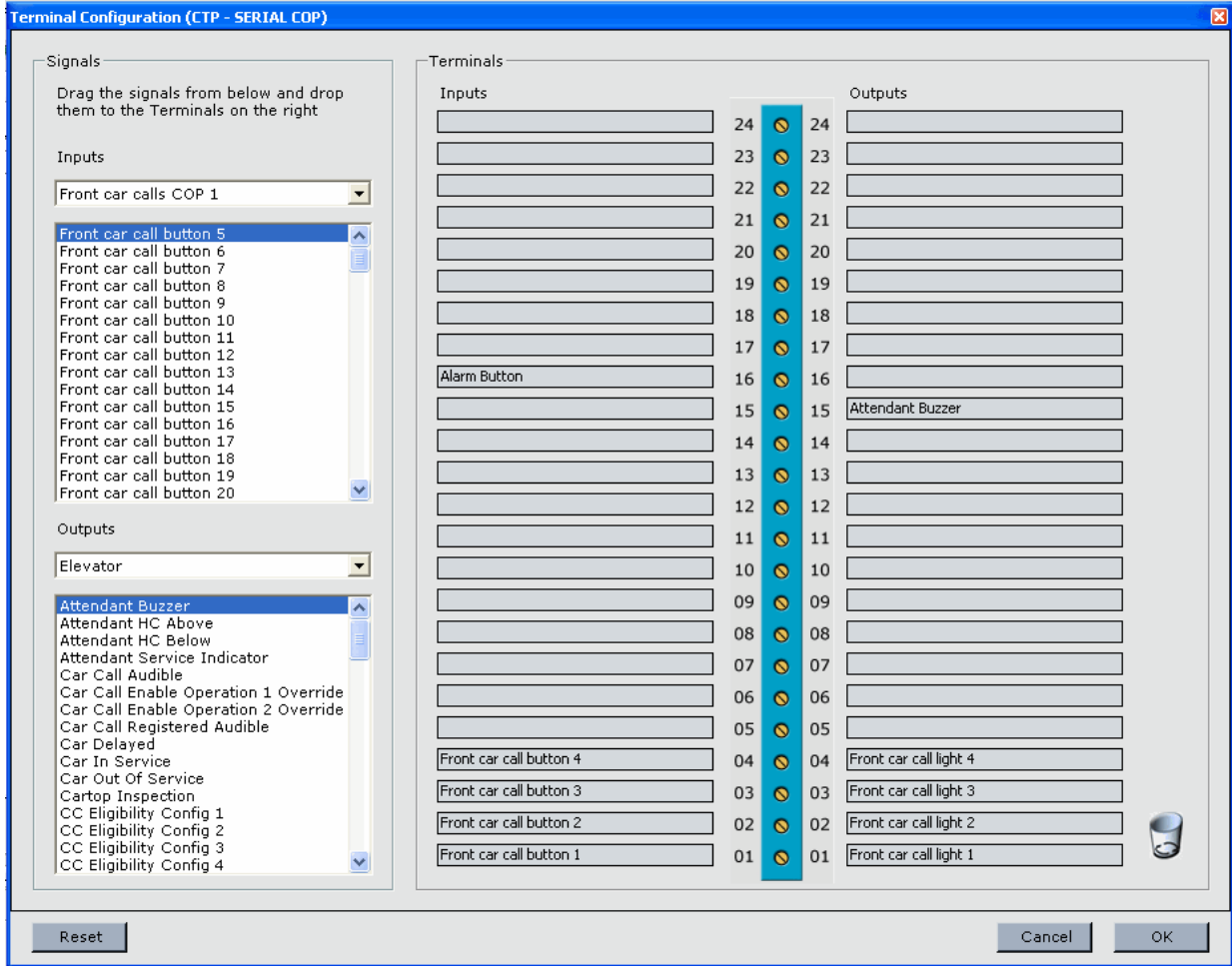
Serial COPs - COP1 thru COP4 In the window shown below, a Serial Car Operating Panel (ICE-COP) board is selected for editing. **Note:** COP4 is not available on Cartop software version 1.1.15 of greater.



- **Edit button:** When the edit button is clicked, the Terminal Configuration (CTP - SERIAL COP) dialog is displayed (see page 9-104).
- **View button:** Use this button to view the current state (On or Off) of the inputs and outputs and to assert a specific state (see “I/O Assert” on page 9-102).
- **Reset COP button:** This button causes the processor on the ICE-COP board to reset.

The method of assigning inputs and outputs to terminals is the same for Serial COP boards as for Multiple Input AC (MIAC) and Multiple Output Relay (MOR) boards. Select a particular signal from the column and drag it to the desired connector pin box. Except for car call button inputs and lamp outputs (shown below), each input or output may be assigned to only a single terminal on the Serial COP boards.

Terminal Configuration (CTP - SERIAL COP)



Caution

The Terminal Configuration dialog reassigns the signal assignments to circuit board pins in controller SOFTWARE. You must also make the correct hard connections to avoid damage or incorrect operation.

I/O Board - Configurable outputs

The controls on the Configurable outputs tab are typically used for freight doors. They specify that the listed door outputs shall be disabled under certain conditions, e.g., Inspection operation, Fire service, etc.

The screenshot shows a software interface for configuring I/O boards. At the top, there are tabs for 'Operational Status' and 'I/O Board'. Under 'I/O Board', there are sub-tabs for 'Configuration' and 'Configurable outputs'. The 'Configurable outputs' tab is active and contains three main sections:

- Disable Door Enable Output:**
 - Inspection operation
 - Test mode
 - In-car emergency stop switch activated and doors open
 - Door stop input activated
- Disable Automatic Closing Output:**
 - Fire service recall complete
 - In-car fire service
 - Independent service
 - Attendant service
 - In-car CFSS mode 1
 - In-car CFSS mode 2
 - In-car Emergency medical service (EMS)
 - Door hold operation activated
- Disable Hall Doors Button Output:**
 - Fire service recall complete
 - In-car fire service
 - Independent service
 - Attendant service
 - In-car CFSS mode 1
 - In-car CFSS mode 2
 - In-car Emergency medical service (EMS)
 - Door hold operation activated

Below these sections is a **Toggle Output** section:

- Enable
- Time on: msec
- Time off: msec

A 'Send' button is located at the bottom right of the configuration area.

- **Disable Door Enable Output:** A check specifies that the Door Enable Output is to be disabled under the selected condition(s).
- **Disable Hall Door Button Output:** A check specifies that the Hall Doors Button Output is to be disabled under the selected condition(s).
- **Disable Automatic Closing Output:** A check specifies that the Hall Doors Button Output is to be disabled under the selected condition(s).
- **Toggle Output:** The Toggle Output (MOR board > Custom Outputs signal) can be used to convert a steady state Custom Output to a toggled output. Use this control to Enable the Toggle Output and to set the On time and Off time of the toggle.

Input Signal Groups

The following signal groups can be programmed on the ICE-MIAC or ICE-COP boards. Depending upon options and configuration, your system may not have all available signals. Refer to your job prints for active signal level and specific connection information.

- Elevator
 - Alarm Button: Input, usually from a button, that initiates and latches the emergency alarm.
 - Alarm Reset: Input to reset the car alarm.
 - Alternate Floor Smoke: Input from the smoke sensors located at the alternate recall floor. Activation of these sensors will initiate recall to the main recall floor.
 - Alternate Speed Profile 1: Input, usually from a keyed switch, that selects the Alternate 1 pattern profile (Configuration > Pattern > Modes tab) for elevator operation. [Please refer to “Pattern - Modes Tab” on page 9-131.](#)
 - Alternate Speed Profile 2: Input, usually from a keyed switch, that selects the Alternate 2 pattern profile (Configuration > Pattern > Modes tab) for elevator operation.
 - Attendant Service: Input, from a key switch, that places the car in Attendant Service operating mode and recalls it to the activating floor. Uses normal operation door parameters and normal performance pattern. Has car call restrictions according to the car call eligibility set selected on the Configuration > General > Car call eligibility tab.
 - Attendant Service Down: Input from a key switch usually located in the car operating panel used to move the car in the down direction while on Attendant Service.
 - Attendant Service Non-Stop: Input from a key-switch usually located in the car operating panel used to bypass hall calls while on Attendant Service.
 - Attendant Service Up: Input from a key switch usually located in the car operating panel used to move the car in the up direction while on Attendant Service.
 - Automatic Stop Input: Input that, when active, will cause the car to stop at a selected floor and cycle its doors for observation before continuing to the destination. Floor and other attributes are selected on the Configuration > Car Operation > Auto stop tab.
 - Backup power recall: Input from the backup power unit used to initiate backup power recall.
 - Backup power recall reverse direction: Input from the backup power unit indicating that direction should be reversed during backup power recall.
 - Backup power unit failure: Input from the backup power unit indicating a failure.
 - Cancel In-Car CFSS Mode 1: Input from an in-car CFSS Mode 1 cancel switch. Activation of this input cancels the “Resume normal service” timer when “In-car switch to activate CFSS” is set to “No switch”, [see “In-car” on page 9-75](#)
 - Cancel In-Car CFSS Mode 2: Input from an in-car CFSS Mode 2 cancel switch (see Cancel In-Car CFSS Mode 1 above).
 - Capture Input: Discrete input used to activate Capture Mode, similar to the iBox Capture switch, see Capture on [page 9-5](#).
 - Car Call Cancel Button: Car operating panel button input to cancel all car calls currently registered on that panel.
 - Car Call Enable 1 Override input: Input that allows Car Call Enable Operation 1 to be overridden, setting car call eligibility to the currently active configuration.

- Car Call Enable 2 Override input: Input that allows Car Call Enable Operation 2 to be overridden, setting car call eligibility to the currently active configuration.
- Car Not Empty Sensor Input: Input from a sensor that detects the presence of passengers in the car. Used with the CFSS “Recall empty car” feature to determine when the car is empty (see [“Car Operation - CFSS Tab” on page 9-73](#)).
- CC Eligibility Config (1 through 8): One of eight inputs used to manually select a particular car call eligibility configuration configured on the General > Car call eligibility tab. If more than one input is active, the lower-numbered input will have control. Please refer to [“General - Car Call Eligibility Tab” on page 9-97](#).
- CFSS In Car Switch 1: Input from an in-car switch that initiates in-car Commandeer For Special Services mode 1 as specified on the Configuration > Car Operation > CFSS tab. Please refer to [“Car Operation - CFSS Tab” on page 9-73](#).
- CFSS In Car Switch 2: Input from an in-car switch that initiates in-car Commandeer For Special Services mode 2 as specified on the Configuration > Car Operation > CFSS tab.
- Emerg. Pwr. Auto Car Select: Input from a key switch, if so set by the user, may be required before the car is automatically selected to run on emergency power. Conditions that affect this operation are specified on the Configuration > Car Operation > Emergency power tab. Please refer to [“Car Operation - Emergency Power Tab” on page 9-70](#).
- Emerg. Pwr. Auto Recall: Input from a key switch, if so set by the user, may be required before the car will recall on emergency power. Conditions that affect this operation are specified on the Configuration > Car Operation > Emergency power tab.
- Emerg. Pwr. Manual Car Select: Input from a key switch used to manually select the car to run on emergency power.
- Emergency Dispatch: Input from a key switch used to force the car to automatically service the building in a pre-defined pattern, cycling the doors when stopping at floors.
- Emergency Dispatch Override: Input from a key switch used to override Emergency Dispatch operation usually manually invoked via the Emergency Dispatch key switch or automatically upon detection of a failure of the hall call bus.
- Emergency Power: Input from a contact closure that indicates whether the system is running on commercial or generator power. Emergency power operation proceeds first in a recall phase, where cars are recalled to a floor and then in a Run phase where one or more cars are selected to run under the emergency power generator using the emergency power performance pattern.
- Emergency Power Manual Override: Input from a key switch or contact closure used to bypass the emergency power recall operation.
- Emergency Power Permission to Run: Input from a contact closure that allows the car to run under the emergency power generator.
- Emergency Power Return: Input from a contact closure that initiates emergency power recall.
- EMS Car Switch: Input from a key switch located inside the car that initiates in-car Emergency Medical Service operation (also referred to as EMS Phase II) allowing the car to be dispatched to a selected floor.
- EMS Hall Switch 1: Input from a key switch used to initiate EMS service 1 recall operation, immediately recalling the car to the specified floor and positioning the doors as

selected (Configuration > Car Operation > EMS tab). [Please refer to “Car Operation - EMS Tab” on page 9-66.](#)

- EMS Hall Switch 2: Input from a key switch used to initiate EMS service 2 recall operation, immediately recalling the car to the specified floor and positioning the doors as selected (Configuration > Car Operation > EMS tab).
- Empty load input: Input from a load weigher discrete output. Used with the CFSS “Recall empty car” feature to determine when the car is empty ([see “Car Operation - CFSS Tab” on page 9-73.](#))
- Fire Phase II Call Cancel Switch: Input from a button on the car operating panel that allows car calls to be cancelled during in-car Firefighter Service.
- Fire Phase II Switch HOLD: Input from a keyed switch in the car that allows firefighters to “hold” the car at a particular floor, disabling the car call buttons while the hold switch is active. Conditions under which the car may be placed on Hold or removed from Hold and how the doors behave while on Hold are determined on the Configuration > Car Operation > Fire Service > Fire Code tabs.
- Fire Phase II Switch OFF: Input from a keyed switch in the car that terminates in-car Firefighter service if appropriate (as specified per code).
- Fire Phase II Switch ON: Input from a keyed switch in the car that places the car in In-Car Firefighters mode if appropriate (as specified per code). Door operation and many other operating parameters are determined by Fire Code selection and any user-unique settings assigned on the Configuration > Car Operation > Fire Service > Fire Code tabs. [Please refer to “Car Operation - Fire Service Tab” on page 9-44.](#)
- Fire Phase II Switch START: Input from the in-car firefighter key switch used to start a run if car calls are registered during in-car firefighter operation.
- Fire Recall Door Open Alt: Input for the hall door open switch at the Alternate Fire Recall floor used with the Fire Recall Door Cycle option. [Please refer to “Car Operation - Fire Service Tab” on page 9-44.](#)
- Fire Recall Door Open Main: Input for the hall door open switch at the Main Fire Recall floor used with the Fire Recall Door Cycle option. [Please refer to “Car Operation - Fire Service Tab” on page 9-44.](#)
- Flood Operation Input: Input that, when active, will cause the car to enter Floor operation mode. Flood operation attributes are selected on the Configuration > Car Operation > Flood operation tab.
- Flood Override Input: When this input is activated, the Flood Operation input is ignored and, if already activated, Flood Operation is canceled.
- Hall Call Bypass Input: Discrete input used to bypass hall calls. Hall calls remain registered until answered. The car is also not eligible for parking.
- Heavy Load Input: Input from a discrete load weigher heavy load output.
- Independent Service: Input, from a key switch, that places the car in Independent Operating mode. Independent Operating mode has unique door operating parameters (Configuration > Car Operation > Independent Service), uses the normal performance pattern, and has car call restrictions according to the car call eligibility set selected on the Configuration > General > Call Eligibility tab. [Please refer to “General - Car Call Eligibility Tab” on page 9-97.](#)
- Light Load Input: Input from a discrete load weigher light load output.

- **Main Floor Smoke:** Input from the smoke sensors located at the main recall floor. Activation of these sensors will initiate recall to the alternate recall floor.
- **Other Cars Alternate:** Input from other car (in the same system) smoke sensors located in the hoistway or machine room if the machine room is located at the main recall floor. Activation of these sensors will initiate recall to the alternate recall floor.
- **Other Cars Main:** Input from other car (in same system) smoke sensors located in the hoistway or machine room if the machine room is located at any floor other than the main recall floor. Activation of these sensors will initiate recall to the main recall floor.
- **Over Load Input:** Input from a discrete load weigher over load output.
- **Passing Floor Gong Enabled:** Input, from a key switch, that enables the audible passing floor gong in the elevator car.
- **Power Transfer:** Input from a key switch or contact closure used to force the car to stop at the next available floor and open its doors. This input is usually used right before power is transferred from the emergency power generator to commercial power.
- **Primary Fire Switch BYPASS:** Input from a keyed switch in the building lobby, that allows a Fire Phase I initiating device (smoke detector, fire alarm, etc.) to be bypassed or unlatched as specified per code.
- **Primary Fire Switch OFF:** Input from a keyed switch in the building lobby, that terminates Fire Phase I if appropriate (as specified per code).
- **Primary Fire Switch ON:** Input from a keyed switch in the building lobby, that initiates Fire Phase I and recalls the car to the main fire recall floor. Recall particulars are fire code specific. Code is selected on the Configuration > Car Operation > Fire Service tab and particulars may be modified on the Fire code tabs.
- **Recall Switch (1 through 6):** One of six switches that places a car in Recall mode, recalling it to an assigned floor. Switch priority, door operation, car call disposition, and more are configured on the Configuration > Car Operation > Elevator recall tab. [Please refer to “Car Operation - Elevator Recall Tab” on page 9-61.](#)
- **Sabbath Operation Switch:** Input from a key switch used to force the car to automatically service the building based on the selected floor eligibility so that the passengers can travel from floor to floor without having to press any buttons.
- **Sabbath Override Input:** When this input is activated, the Sabbath Operation Switch input is ignored and, if already activated, Sabbath Operation is cancelled.
- **Secondary Fire Switch ON:** Input from a keyed switch in a different location than the Primary Fire Switch, that initiates Fire Phase I and recalls the car to the alternate fire recall floor. Recall particulars are fire code specific.
- **Shuttle Service:** Input from a key switch used to turn Shuttle service On and Off.
- **Shuttle Service Override:** Input from a key switch used to override Shuttle service.
- **Swing Automatic Operation:** When activated, the car will automatically enter Swing operation when a hall call is received from the Swing riser. Automatic Swing operation assumes an “always active” Swing riser.
- **Swing Operation Switch:** Input from a key switch used to take the car out of group dispatching operation allowing it to service a dedicated hall call riser and perform its own parking, hall call service and security based on the System parameters programmed and stored on the Swing car’s iBox ([see “Automatic Swing Operation” on page 9-39](#))
- **This Car Alternate:** Input from the smoke sensors located in the hoistway or machine room if the machine room is located at the main recall floor and if the car has any

equipment in that hoistway or machine room. Activation of sensors will initiate recall to the alternate recall floor and cause the fire warning indicator in the car to flash.

- **This Car Main:** Input from the smoke sensors located in the hoistway or machine room if the machine room is at any floor other than the main recall floor and if the car has any equipment in that hoistway or machine room. Activation of sensors will initiate recall to the main recall floor and cause the fire warning indicator in the car to flash.
- **Front Door**
 - **Disable Front Hall Door Buttons:** Input used to disable the front hall door buttons.
 - **Front COP2 Door Close Button:** Input from the front auxiliary door close button:
 - **Front COP2 Door Hold Button:** Input from the front auxiliary door hold button.
 - **Front COP2 Door Open Button:** Input from the front auxiliary door open button.
 - **Front COP2 Door Stop Button:** Input from the front auxiliary door stop button (active low).
 - **Front Constant Pressure Close:** Activation overrides front door close software settings.
 - **Front Constant Pressure Open:** Activation overrides front door open software settings.
 - **Front Door Close Button (COP1):** Input from the front main door close button.
 - **Front Door Hold Button (COP1):** Input from the front main door hold button.
 - **Front Door Open Button (COP1):** Input from the front main door open button.
 - **Front Door Stop Button (COP1):** Input from front main door stop button (active low).
 - **Front Hall Door Close Button:** Input from a front hall door close button.
 - **Front Hall Door Hold Button:** Input from a front hall door hold button.
 - **Front Hall Door Open Button:** Input from a front hall door open button.
 - **Front Hall Door Stop Button:** Input from a front hall door stop button (active low).
 - **Front Momentary Pressure Close:** Overrides front door close software setting.
 - **Front Momentary Pressure Open:** Overrides front door open software setting.
 - **Front Photo Eye Cut Out:** Input from a front key switch - disables photo eye operation
- **Rear Door**
 - **Disable Rear Hall Door Buttons:** Input used to disable the rear hall door buttons.
 - **Rear COP2 Door Close Button:** Input from the rear auxiliary door close button:
 - **Rear COP2 Door Hold Button:** Input from the rear auxiliary door hold button.
 - **Rear COP2 Door Open Button:** Input from the rear auxiliary door Open button.
 - **Rear COP2 Door Stop Button:** Input from the rear auxiliary door stop button (active low).
 - **Rear Constant Pressure Close:** Activation overrides rear door close software settings.
 - **Rear Constant Pressure Open:** Activation overrides rear door open software settings.
 - **Rear Door Close Button (COP1):** Input from the rear main door close button.
 - **Rear Door Close Limit:** Input from rear Door Close Limit switch.
 - **Rear Door Hold Button (COP1):** Input from the rear main door hold button.
 - **Rear Door Open Button (COP1):** Input from the rear main door open button.
 - **Rear Door Open Limit:** Input from rear Door Open Limit switch.

- Rear Door Photo Eye: Input from rear door photo eye.
- Rear door safe edge: Input from rear door safe edge.
- Rear Door Stop Button (COP1): Input from rear main door stop button (active low).
- Rear Hall Door Close Button: Input from a rear hall door close button.
- Rear Hall Door Hold Button: Input from a rear hall door hold button.
- Rear Hall Door Open Button: Input from a rear hall door open button.
- Rear Hall Door Stop Button: Input from a rear hall door stop button (active low).
- Rear Momentary Pressure Close: Activation overrides rear door close software setting.
- Rear Momentary Pressure Open: Activation overrides rear door open software setting.
- Rear Photo Eye Cut Out: Input from the rear key switch that disables rear door photo eye operation.

- Car Calls - Front COP1:
 - Car Call - Front COP1 button, Floor 1 —150: Inputs from front car call buttons for non-serial, front, car operating panel 1.
 - Sequential Step Scan Up Front COP 1: [Sequential step scan car calls](#) option input.
 - Sequential Step Scan Down Front COP1: [Sequential step scan car calls](#) option input.
 - Disable Front COP 1: Input used to disable the front car call and door buttons of the main Car Operating Panel.

- Car Calls - Rear COP1
 - Car Call - Rear COP 1 button, Floor 1 —150: Inputs from rear car call buttons for non-serial, rear, car operating panel 1.
 - Sequential Step Scan Up Rear COP 1: [Sequential step scan car calls](#) option input.
 - Sequential Step Scan Down Rear COP1: [Sequential step scan car calls](#) option input.
 - Disable Rear COP 1: Input used to disable the rear car call and door buttons of the main Car Operating Panel.

- Car Calls - Front COP2
 - Car Call - Front COP 2 button, Floor 1 —150: Inputs from front car call buttons for non-serial, front, car operating panel 2.
 - Sequential Step Scan Up Front COP 2: [Sequential step scan car calls](#) option input.
 - Sequential Step Scan Down Front COP2: [Sequential step scan car calls](#) option input.
 - Disable Front COP 2: Input used to disable the front car call and door buttons of the auxiliary Car Operating Panel.

- Car Calls - Rear COP2
 - Car Call - Rear COP 2 button, Floor 1 —150: Inputs from rear car call buttons for non-serial, rear, car operating panel 2.
 - Sequential Step Scan Up Rear COP 2: [Sequential step scan car calls](#) option input.
 - Sequential Step Scan Down Rear COP2: [Sequential step scan car calls](#) option input.
 - Disable Rear COP 2: Input used to disable the rear car call and door buttons of the auxiliary Car Operating Panel

- .Car Call Enable 1 - Front
 - Car Call Enable 1 - Front, Floor 1 —150: Per floor, non-serial inputs from car call enable 1 - front door device (card reader or keypad, etc.).
- Car Call Enable 1 - Rear
 - Car Call Enable 1 - Rear, Floor 1 —150: Per floor, non-serial inputs from car call enable 1 - rear door device (card reader or keypad, etc.).
- Car Call Enable 2 - Front
 - Car Call Enable 2 - Front, Floor 1 —150: Per floor, non-serial inputs from car call enable 2 - front door device (card reader or keypad, etc.).
- Car Call Enable 2 - Rear
 - Car Call Enable 2 - Rear, Floor 1 —150: Per floor, non-serial inputs from car call enable 2 - rear door device (card reader or keypad, etc.).
- Motor and Drive
 - Governor Speed Reduction Switch: Input from Governor Speed Reduction Switch.
 - Sheave Brake Monitor: Input from the sheave brake monitor.
 - Brake Switch: This input can be used in place of input SP2D. The “Switch” parameters on the Controller > Configuration > Brake > Control tab determine the state of the input (high or low) that indicates the brake is picked.
- System Configurations (Simplex)
 - Hall Call Eligibility Config (1 - 8): Activation of a Hall Call Eligibility Configuration (1 - 8) input causes the respective configuration to be the active configuration.
 - Parking Config (1 - 8): Activation of a Parking Configuration (1 - 8) input causes the respective configuration to be the active configuration.
 - Parking Eligibility Config (1 - 8): Activation of a Parking Eligibility Configuration (1 - 8) input causes the respective configuration to be the active configuration.
 - Mode of Operation Config (1 - 8): Activation of a Mode of Operation Configuration (1 - 8) input causes the respective configuration to be the active configuration.
 - Security Config (1 - 8): Activation of a Security Configuration (1 - 8) input causes the respective configuration to be the active configuration.
 - Master Security Override input: Activation of this input overrides all elevator security.
 - Hall Call Security 1 Override input: Activation of this input overrides Hall Call Security 1 security.
 - Hall Call Security 2 Override input: Activation of this input overrides Hall Call Security 2 security.
- Hall Calls - Aux Front Down
 - Hall Call - Aux Front Down Button (1 - 150): Non-serial inputs from front aux down hall call buttons.
- Hall Calls - Aux Rear Down
 - Hall Calls - Aux Rear Down Button (1 - 150): Non-serial inputs from rear aux down hall call buttons.

- Hall Calls - Main Front Down
 - Hall Calls - Main Front Down Button (1 - 150): Non-serial inputs from front main down hall call buttons.
- Hall Calls - Main Rear Down
 - Hall Calls - Main Rear Down Button (1 - 150): Non-serial inputs from rear main down hall call buttons.
- Hall Calls - Aux Front Up
 - Hall Calls - Aux Front Up Button (1 - 150): Non-serial inputs from front aux up hall call buttons.
- Hall Calls - Aux Rear Up
 - Hall Calls - Aux Rear Up Button (1 - 150): Non-serial inputs from rear aux up hall call buttons.
- Hall Calls - Main Front Up
 - Hall Calls - Main Front Up Button (1 - 150): Non-serial inputs from front main up hall call buttons.
- Hall Calls - Main Rear Up
 - Hall Calls - Main Rear Up Button (1 - 150): Non-serial inputs from rear main up hall call buttons.
- CFSS Calls - CFSS 1 Front
 - CFSS Call - CFSS 1 Front Input (1 - 150): Non-serial inputs from CFSS 1 front call switches.
- CFSS Calls - CFSS 1 Rear
 - CFSS Call - CFSS 1 Rear Input (1 - 150): Non-serial inputs from CFSS 1 rear call switches.
- CFSS Calls - CFSS 2 Front
 - CFSS Call - CFSS 2 Front Input (1 - 150): Non-serial inputs from CFSS 2 front call switches.
- CFSS Calls - CFSS 2 Rear
 - CFSS Call - CFSS 2 Rear Input (1 - 150): Non-serial inputs from CFSS 2 rear call switches.
- Hall Call Enable 1 (2) - Floor
 - Hall Call Enable 1 (2) - Floor (1 - 150): Non-serial floor inputs from Hall call enable 1 (2) devices (card reader or keypad etc.).
- Hall Call Enable 1 (2) - Front
 - Hall Call Enable 1 (2) - Front, Floor (1 - 150): Non-serial front inputs from Hall call enable 1 (2) devices (card reader or keypad etc.).
- Hall Call Enable 1 (2) - Rear
 - Hall Call Enable 1 (2) - Rear, Floor (1 - 150): Non-serial rear inputs from Hall call enable 1 (2) devices (card reader or keypad etc.).
- Hall Call Enable 1 (2) - Main Front
 - Hall Call Enable 1 (2) - Main Front, Floor (1 - 150): Non-serial main front inputs from Hall call enable 1 (2) devices (card reader or keypad etc.).

- Hall Call Enable 1 (2) - Main Rear
 - Hall Call Enable 1 (2) - Main Rear, Floor (1 - 150): Non-serial main rear inputs from Hall call enable 1 (2) devices (card reader or keypad etc.).
- Hall Call Enable 1 (2) - Aux Front
 - Hall Call Enable 1 (2) - Aux Front, Floor (1 - 150): Non-serial aux front inputs from Hall call enable 1 (2) devices (card reader or keypad etc.).
- Hall Call Enable 1 (2) - Aux Rear
 - Hall Call Enable 1 (2) - Aux Rear, Floor (1 - 150): Non-serial aux rear inputs from Hall call enable 1 (2) devices (card reader or keypad etc.).
- Hall Call Enable 1 (2) - Aux Front Down
 - Hall Call Enable 1 (2) - Down Aux Front, Floor (1 - 150): Non-serial down aux front inputs from Hall call enable 1 (2) devices (card reader or keypad etc.).
- Hall Call Enable 1 (2) - Aux Rear Down
 - Hall Call Enable 1 (2) - Down Aux Rear, Floor (1 - 150): Non-serial down aux rear inputs from Hall call enable 1 (2) devices (card reader or keypad etc.).
- Hall Call Enable 1 (2) - Aux Rear Up
 - Hall Call Enable 1 (2) - Up Aux Rear, Floor (1 - 150): Non-serial up aux rear inputs from Hall call enable 1 (2) devices (card reader or keypad etc.).
- Hall Call Enable 1 (2) - Main Front Down
 - Hall Call Enable 1 (2) - Down Main Front, Floor (1 - 150): Non-serial down main front inputs from Hall call enable 1 (2) devices (card reader or keypad etc.).
- Hall Call Enable 1 (2) - Main Rear Down
 - Hall Call Enable 1 (2) - Down Main Rear, Floor (1 - 150): Non-serial down main rear inputs from Hall call enable 1 (2) devices (card reader or keypad etc.).
- Hall Call Enable 1 (2) - Main Front Up
 - Hall Call Enable 1 (2) - Up Main Front, Floor (1 - 150): Non-serial up main front inputs from Hall call enable 1 (2) devices (card reader or keypad etc.).
- Hall Call Enable 1 (2) - Main Rear Up
 - Hall Call Enable 1 (2) - Up Main Rear, Floor (1 - 150): Non-serial up main rear inputs from Hall call enable 1 (2) devices (card reader or keypad etc.).
- CFSS 1 (2) Enable 1 (2) - Floor
 - CFSS 1 (2) Enable 1 (2) - Floor (1 - 150): Non-serial CFSS mode 1 (2) inputs from Hall call enable 1 (2) devices (card reader or keypad etc.).
- CFSS 1 (2) Enable 1 (2) - Front
 - CFSS 1 (2) Enable 1 (2) - Front, Floor (1 - 150): Non-serial CFSS mode 1 (2) front inputs from Hall call enable 1 (2) devices (card reader or keypad etc.).
- CFSS 1 (2) Enable 1 (2) - Rear
 - CFSS 1 (2) Enable 1 (2) - Rear, Floor (1 - 150): Non-serial CFSS mode 1 (2) rear inputs from Hall call enable 1 (2) devices (card reader or keypad etc.).
- User Defined Events
 - User Event (1 - 10): Activation of a User Event (1 - 10) input causes the corresponding User Event (1 - 10) to be activated (Configuration > User-Defined Inputs tab).

- Heat Detectors
 - Machine Room Heat Detectors: Signals that a machine room heat detector is activated.
 - Hoistway Heat Detectors: Signals that a hoistway heat detector is activated.
 - Heat Detectors Floor (1 - 150): Signals that a heat detector on floor (1 - 150) is activated.
- User Serial Fixtures Messages
 - User Serial Fixture Message (1 - 4): Signals that cause user defined messages to be displayed and/or announced on the serial fixtures (see “Serial Fixture Tab” on page 9-35).

Output Signal Groups

Outputs are logic-enabled and provide current/voltage or a path to ground as determined by the common shared by the particular relay group. Refer to your job prints for active signal level and specific connection information. The following output groups can be programmed on the ICE-MOR or ICE-COP boards.

- Elevator
 - Alarm Buzzer: Activated if the Emergency Stop Switch or Alarm Bell input are activated and will pulsate if the SAFH, SAFC or GOV inputs go low or if the TDISL input is used. It is reset using the “Emergency Alarm Reset input”. Configure using the Configuration > Car Operation > Devices tab (Emergency Alarm Monitoring parameters).
 - Alarm Light: Activated due to an extended safety string fault, emergency stop switch or alarm bell activation. It is reset using the “Emergency Alarm Reset input”. Configure using the Configuration > Car Operation > Devices tab (Emergency Alarm Monitoring parameters).
 - Attendant Buzzer: This output turns on momentarily (activates an in-car buzzer) to indicate that a hall call button has been pressed while the elevator is on attendant operation.
 - Attendant Hall Call Above: While on attendant operation, this output comes on to indicate that the car has been assigned to answer a hall call above the car (normally used to activate an indicator light to alert the attendant).
 - Attendant Hall Call Below: While on attendant operation, this output comes on to indicate that the car has been assigned to answer a hall call below the car (normally used to activate an indicator light to alert the attendant).
 - Attendant Service Indicator: Active when the car is on Attendant service.
 - Available for fire service: Active when the car is available for fire service operation.
 - Backup power recall done: The car is at a floor and the required door operations have been completed.
 - Car Call Audible: Active momentarily when a call is entered. Used for certain CSA applications that require ‘barrier free’ operation.
 - Car Call Enable 1 (2) Override output: These respective outputs are active when the Car Call Enable 1 (or 2) Override is active.
 - Car Call Registered Audible: This output comes on momentarily when a car call is registered. It is used for certain CSA applications that require “barrier free” operation.

- **Car Delayed:** The Car delayed timer (Configuration > Car Operation > Passenger tab) starts whenever there is demand. This output turns on if the Car delayed timer expires before the car reaches the demanded destination.
- **Car In Service:** This output is on when the car operating in normal Passenger mode. It is used by parking and arrival gong logic and is cleared by fire service and inspection operation, and also when the “Car out of service timer” expires or when the heavy load threshold is exceeded. The Car out of service timer is set on the Configuration > Car Operation > Passenger tab
- **Car Out Of Service:** This output is on when the car is not operating in normal Passenger mode.
- **Cartop Inspection:** Active when the car is on cartop inspection operation.
- **CC Eligibility Config 1 through 8:** These respective outputs indicate that a particular car call eligibility configuration has been selected on the Configuration > General > Car Call Eligibility tab or via an input (inputs override software selection).
- **CFSS Car Buzzer 1 (2):** These respective outputs are turned On whenever the car has been assigned a CFSS call. The output remains On until the CFSS call is answered or de-assigned (see Configuration > Car Operation > CFSS tab).
- **CFSS Car Light 1 (2):** These respective outputs are used to activate an in-car visual warning indicator associated with Commandeer for Special Service Mode 1 or Mode 2. The output is activated when CFFS Mode 1 (or 2) is activated and remains so until the in-car switch is activated or the “Resume normal service timer” expires (Configuration > Car Operation > CFSS tab).
- **CFSS Mode 1 (2) In-Use (Simplex):** These respective outputs are active when the car is on CFSS Mode 1 or CFSS Mode 2 as specified on the Configuration > Car Operation > CFSS tab.
- **CFSS Mode 1 (2) System (Simplex):** These respective outputs are active when the car is on CFSS Mode 1 or CFSS Mode 2 as specified on the Configuration > Car Operation > CFSS tab.
- **Commercial Power:** This output is active when the controller is on commercial power.
- **Counterweight Derailment:** Activated when the car counterweight derailment circuit on the Earth Quake (ICE-IEQ) board is latched. The output remains on until the Reset switch on the EQ board is pressed.
- **Delayed Mechanically In Service:** Use with Emergency Power Overlay logic. This output is “normally” active (when the car is running normally), but is turned “off” when the car appears to be “mechanically” out of service. There is a delay in the dropping of this output for emergency power timing. Only two statuses are checked for the clearing of this output: Safety String and Motor Limit Timer.
- **Direction Arrow Down:** Active when the car’s current or intended direction is down.
- **Direction arrow down 2:** (see Direction Arrow Down) This output is disabled during Fire service to accommodate the ASME A17.1 code requirement to disable hall fixtures at all floors except the lobby during Fire service.
- **Direction Arrow Up:** Active when the car’s current or intended direction is up.
- **Direction arrow up 2:** (see Direction Arrow Up) This output is disabled during Fire service to accommodate the ASME A17.1 code requirement to disable hall fixtures at all floors except the lobby during Fire service.

- **Earthquake Buzzer:** Active when the car is on Earthquake operation (earthquake sensor or counterweight derailment inputs active).
- **Earthquake Light:** Active when the car is on Earthquake operation (earthquake sensor or counterweight derailment inputs active).
- **Egress Floor Gong:** This output will activate for 300 msec. when the car arrives at the “egress” floor and opens the doors in response to a hall or car call. This output is used to activate an audible indicator to inform visually impaired passengers that the elevator has arrived at the main egress floor of the building. The egress floor is selected on the Configuration > Car Operation > Passenger tab.
- **Emerg. Pwr. Car Selected to Recall:** Active when this car is selected to lower the recall floor on emergency power.
- **Emerg. Pwr. Car Selected to Run:** Active when this car is selected to run on emergency power (see Configuration > Car Operation > Emergency power tab).
- **Emergency Power Car Done Recall:** Active when the car has completed the recall on Emergency Power operation.
- **Emergency Power Phase I (Simplex):** Activated when the Emergency Power input is activated and remains on until all cars have returned to the recall floor.
- **Emergency Power Phase II (Simplex):** Activated when all car have reached the recall floor and remains on until normal power is reinstated.
- **Emergency Power Priority Status:** Activated when the car is on EMS phase 2, CFSS phase 2 and Fire Service Phase II.
- **Emergency Power Recall Complete:** Activated when the car is on Emergency Power and is at the recall floor with the doors fully open.
- **Emergency Power Service (Simplex):** Active when the car is on Emergency Power (Emergency Power input active). Configure using Configuration > Car Operation > Emergency power tab.
- **EMS Car Buzzer:** This output comes on when the EMS 1 or EMS2 hall switch is activated and turns off when the car reaches the EMS floor (phase 1 return). It is used to activate an in-car audible buzzer to alert passengers that the car is being commanded for Emergency Medical Service.
- **EMS Car Light:** This output comes on when the EMS 1 or EMS2 hall switch is activated and stays on until the car returns to normal service. It is used to activate a visual indicator to alert passengers that the car is on Emergency Medical Service.
- **EMS Hall Light 1 (2):** These respective outputs come on when the EMS1 (or 2) hall switch is activated and turns off when the in-car switch is activated. It is used to activate a visual indicator to alert EMS personnel that the EMS1 or EMS2 signal has been registered. EMS settings and configured on the iView Configuration > Car Operation > EMS tab.
- **Empty Car Output:** This output is active when one or more of the following are true: Empty Load Input = On, Car Not Empty Sensor Input = Off or the car weight is below the Empty load threshold setting on the Configuration > Load Weigher tab.
- **Empty Load:** This output is active when the car weight from an analog load weigher is below the Empty load threshold on the Configuration > Load Weigher tab or the discrete Empty Load Input is On.

- **EP Car Selected to Run or Recall:** This output is active when the car is selected to lower or run on emergency power. Conditions that affect this operation are specified on the Configuration > Car Operation > Emergency Power tab.
- **Fan and Light Indicator:** This output is normally off and will turn on when the car is at rest long enough for the “Car fan and light timer” (Configuration > Car Operation > Passenger tab) to time out.
- **Fire I Light:** This output is on when the car is in Fire phase I recall to the main or alternate fire floor. It turns off when then-car firefighter’s switch is activated.
- **Fire II Light:** Active when the in-car firefighters switch is active (fire phase II).
- **Fire Recall:** Active when the car is in Fire phase I recall to the main or alternate recall floor.
- **Fire Service Phase I Return Complete:** This output is normally on and turns “off” to indicate that the car has successfully completed the Fire service phase I recall function (the car is positioned at the fire recall floor with its doors open). It turns back on when phase 2 switch is turned on. It is most often used as a signal that it is O.K. to remove power from the control equipment and start the machine room sprinklers.
- **Fire Warning Buzzer:** This output comes on when fire service phase I is initiated.
- **Fire Warning Light:** This output will be solid on during fire service phase I and II. The output will flash only if the machine room or hoistway fire sensors have tripped.
- **Firefighter’s Panel Unlock:** Activated when the car reaches the recall floor. Used to unlock the fire panel.
- **Flood Operation Buzzer:** Active when the car is on Flood Operation (set parameters on the Configuration > Car Operation > Flood Operation tab).
- **Flood Operation Status:** Active when the car is on Flood Operation (set parameters on the Configuration > Car Operation > Flood Operation tab).
- **Gate Release Solenoid:** Typically used on horizontally sliding fully manual doors to release the car gate and allow it to close. This output is ON when the hoistway doors are closed and there is a demand to move the car. It is turned OFF when both car gates are fully closed.
- **Gong Enable Down Front:** This output comes on whenever the car passes a floor with a front opening in the DOWN direction and the passing floor going enable button has been activated.
- **Gong Enable Down Rear:** This output comes on whenever the car passes a floor with a rear opening in the DOWN direction and the passing floor going enable button has been activated.
- **Gong Enable Up Front:** This output comes on whenever the car passes a floor with a front opening in the UP direction and the passing floor going enable button has been activated.
- **Gong Enable Up Rear:** This output comes on whenever the car passes a floor with a rear opening in the UP direction and the passing floor going enable button has been activated.
- **Heavy Load:** This output is activated when the load in the elevator exceeds the threshold set for “hall call bypass” on the Configuration > Load Weigher tab. The “load status” will only change once the car has stopped at a landing and has opened its doors.
- **Hoistway Inspection:** Active when the car is on Hoistway-Access Inspection operation.

- **In-Car Fire Door Operation:** This output is typically used by the freight door controller to adjust the door operation per the code requirements for in-car fire service and in-car fire service recall operations. This output is ON during in-car fire service and also during in-car fire service recall until the doors are fully closed.
- **In-Car Fire Hold:** This output is ON during In-car fire service hold operation.
- **In-Car Fire Recall:** Typically used to re-enable the hall door buttons station during in-car fire service recall, this output is ON during In-car fire service recall operation.
- **In-Car Inspection:** Active when the car is on in-car inspection operation.
- **Independent Service Indicator:** Active when the car is on Independent service.
- **Inspection Output:** Active when the car is on any Inspection operation.
- **Light Load:** Activated when the Light Load Input is active or when the weight in the car, detected by an analog load weigher, is less than the Light load threshold.
- **Machine Room Inspection:** Active when the car is on machine room inspection operation.
- **Mechanically In Service:** This output is “normally” active (when the car is running normally), but is turned off when the car appears to be mechanically out of service. Only two statuses are checked for clearing this output: Safety String and Motor Limit Timer.
- **Overload:** This output is on when the overload threshold, value at which it may be considered unsafe to move the elevator, has been reached. The car will remain at the floor with doors open (overridden by fire phase II). Typically a visual and/or audible indicator is used to alert passengers that the car is overloaded.
- **Pass Code Failure:** Activated momentarily when the time limit expires prior to a correct pass code having been entered on the Car Operating Panel.
- **Pass Code Success:** Activated momentarily when a correct pass code is entered at the Car Operating Panel.
- **Passing Floor Gong:** This output is on whenever the car passes a floor. Timer options are located on the iView Configuration > Car Operation > Devices tab.
- **Passing Floor Gong Enabled:** This output comes on whenever the car passes a floor and the passing floor gong enable button has been pushed. Timer options are located on the iView Configuration > Car Operation > Devices tab.
- **Recall Switch 1 through 6:** One of six outputs indicating that its respective switch has been activated and has placed a car in Recall mode, recalling it to an assigned floor. Switch priority, door operation, car call disposition and more are configured on the iView Configuration > Car Operation > Elevator recall tab.
- **Retiring Cam:** This output is turned ON to lock the hoistway doors if all doors (front and rear) are fully closed and there is a demand to move the car. Otherwise it is OFF. This output is turned OFF if the car is stopped in between floors.
- **Sabbath Operation Indicator:** This output is on when the car is on Sabbath operation (Configuration > Car Operation > Sabbath operation tab).
- **Seismic Switch:** Activated when the seismic switch circuitry on the Earth Quake (ICE-IEQ) board is latched. Remains on until the Reset switch on the EQ board is pressed.
- **Shuttle service:** This output is on when the car is on Shuttle service (Configuration > Car Operation > Shuttle service tab)
- **Swing Operation Indicator:** This output is on when the car is on Swing operation. Hall call service is based on parameters set on the Configuration > Swing Configuration

tabs. Automatic swing operation is enabled on the Configuration > Car Operation > Passenger tab. Car call eligibility is set on the Configuration > General > Car call eligibility tab.

- Test Mode: Active when the car is on Test mode operation.
- Front Door — Rear Door
 - Front (Rear) Car Gong: This output is activated to announce the elevator's intention to go up or down after the car steps into a floor by sounding the front or rear car gong. Timer options located on Configuration > Car Operation > Devices tab.
 - Front (Rear) Closing Warning Buzzer: This output is active, before automatic closing of the front or rear doors, for the length of time indicated by the “Door closing delay timer” on the Configuration > Car Operation > Doors > Front or Rear tab. The door close warning buzzer is required for power operated vertically sliding doors whenever they are closed automatically or with momentary pressure. It must come on at least 5 seconds prior to the start of closing and stays on until the front/rear doors are closed. For momentary pressure closing, when the in-car front/rear door close button is pressed, the 5 second closing delay may be omitted.
 - Front (Rear) Disable Automatic Close: Used to disable automatic closing, these outputs are normally OFF and can be configured, on the Configuration > I/O Board > Configurable outputs tab, to turn ON during any combination of the following modes/conditions: In-car fire service, Independent service, Attendant service, In-car CFSS mode 1 (2) operation, In-car EMS operation, Door hold button or timer activation.
 - Front (Rear) Disable Hall Door Buttons: Used to disable the hall door buttons station, this output is normally OFF and can be configured, on the Configuration > I/O Board > Configurable outputs tab, to turn ON during any combination of the following modes and/or conditions: In-car fire service, Independent service, Attendant service, In-car CFSS mode 1 (2) operation, In-car EMS operation, Door hold button or timer activation.
 - Front (Rear) Door Close Limit: Inactive when the doors are fully closed.
 - Front (Rear) Door Enable: Used to cut power to front/rear doors, these outputs are normally ON and can be configured, on the Configuration > I/O Board > Configurable outputs tab, to turn OFF during any combination of the following modes and/or conditions: Test mode, Inspection operation, In-car stop switch activated and doors are fully open, Door stop input activated.
 - Front (Rear) Door Hold End: This output turns on five seconds prior to expiration of the “Door hold” timer (see Front (Rear) Door Hold Function).
 - Front (Rear) Door Hold Function: This output is active during the time the doors are being held by the “Door hold” timer (Configuration > Car Operation > Passenger > Door Operation - Door Dwell Timers).
 - Front (Rear) Door Left Open: This output is used for non-automatic front/rear doors and shall be ON if the front/rear doors are open and a hall call button is pressed. Otherwise it shall be OFF.
 - Front (Rear) Door Lock Power: This output is activated when the doors are closed and locked and is used for door operators that need a separate signal to hold the doors closed.
 - Front (Rear) Down Car Lantern: This output is activated (usually a double ding: on-off-on) to announce the elevator's intention to go down after the doors start to open by operating the front or rear in-car gong/lantern assembly. This will happen when a

down hall call has been entered and the car has reached the floor from which that call originated, or the doors are open and a car call is entered for a floor below. Timer options are located on the Configuration > Car Operation > Devices tab.

- Front (Rear) Nudging Audible: This output is activated when door nudging has been activated. Options located on Configuration > Car Operation > Passenger tab.
- Front (Rear) Door This Car Up: This output is active when the car is at the lobby floor and has been selected as the next car to go in the UP direction.
- Front (Rear) Up Car Lantern: This output is activated (usually a single ding) to announce the elevator's intention to go up after the doors start to open by operating the front or rear in-car gong/lantern assembly. This will happen when an up hall call has been entered and the car has reached the floor from which that call originated, or the doors are open and a car call is entered for a floor above. Timer options are located on the Configuration > Car Operation > Devices tab.
- Car Calls - Front COP 1
 - Car Call - Front COP 1 light, Floor 1—150: Outputs to the front Car Operating Panel 1 lights.
- Car Calls - Rear COP 1
 - Car Call - Rear COP 1 light, Floor 1—150: Outputs to the rear Car Operating Panel 1 lights.
- Car Calls - Front COP 2
 - Car Call - Front COP 2 light, Floor 1—150: Outputs to the front Car Operating Panel 2 lights.
- Car Calls - Rear COP 2
 - Car Call - Rear COP 2 light, Floor 1—150: Outputs to the rear Car Operating Panel 2 lights.
- Position indicators Binary Outputs I
 - Binary Position Indicator I, Output 1— 8: Outputs 1 through 8 to Binary Position Indicator I. Outputs I will stay active during Fire Service.
- Position indicators Binary Outputs II
 - Binary Position Indicators II, Output 1—8: Outputs 1 through 8 to Binary Position Indicator II. Outputs II will deactivate during Fire Service.
- Position indicators Single Outputs I
 - Position Indicators Single I, Floor 1—64: Outputs to one line per floor position indicators. Outputs I will stay active during Fire Service.
- Position indicators Single Outputs II
 - Position Indicators Single II, Floor 1—64: Outputs to one line per floor position indicators. Outputs II will deactivate during Fire Service.
- Position indicators Rotodial Outputs I
 - Rotodial Position Indicators I, Output 1—3: Outputs created for the “Rotodial” brand position indicators. These three outputs change in a specified pattern to cause the rotodial device to rotate in the appropriate direction. Outputs I will stay active during Fire Service.
- Position indicators Rotodial Outputs II

- Rotodial Position Indicators II, Output 1—3: Outputs created for the “Rotodial” brand position indicators. These three outputs change in a specified pattern to cause the rotodial device to rotate in the appropriate direction. Outputs II will deactivate during Fire Service.
- Hall lanterns - Front up
 - Hall lantern - Front up, Floor 1—150: This output is generated to activate the front door hall gong/lantern assembly. Options are set on the Configuration > Car Operation > Devices tab.
- Hall lanterns - Front down
 - Hall lantern - Front down, Floor 1—150: This output is generated to activate the front door hall gong/lantern assembly. Options are set on the Configuration > Car Operation > Devices tab.
- Hall lanterns - Rear up
 - Hall lantern - Rear up, Floor 1—150: This output is generated to activate the rear door hall gong/lantern assembly. Options are set on the Configuration > Car Operation > Devices tab.
- Hall lanterns - Rear down
 - Hall lantern - Rear down, Floor 1—150: This output is generated to activate the rear door hall gong/lantern assembly. Options are set on the Configuration > Car Operation > Devices tab.
- Hall gongs - Front
 - Hall gongs - Front, Floor 1—150: This output is generated to activate a separate front door hall gong.
- Hall gongs - Rear
 - Hall gongs - Rear, Floor 1—150: This output is generated to activate a separate rear door hall gong.
- Motor and Drive
 - Brake Holding Voltage: This output turns ON for hardware driven Brake picking to Holding voltage. The Hold delay timer option is located on Configuration > Brake > Timers tab.
 - Motor Blower: This output for the Motor Blower is ON when car is in motion and for the duration of the time setting of the Motor blower hold delay timer on the Configuration > Drive > General tab.
 - Sheave Brake Enable: Used to enable the emergency brake function. The Emergency Brake - Sheave brake options must be selected on the Configuration > Safety tab.
- Melina PI display Outputs I (Left)
 - Left Character 9—22: Outputs to the Melina position indicator for the left character. Outputs I will stay active during Fire Service.
- Melina PI display Outputs I (Middle)
 - Middle Character 9—22: Outputs to the Melina position indicator for the middle character. Outputs I will stay active during Fire Service.
- Melina PI display Outputs I (Right)
 - Right Character 9—22: Outputs to the Melina position indicator for the right character. Outputs I will stay active during Fire Service.

- Melina PI display Outputs II (Left)
 - Left Character 9—22: Outputs to the Melina position indicator for the left character. Outputs II will deactivate during Fire Service.
- Melina PI display Outputs II (Middle)
 - Middle Character 9—22: Outputs to the Melina position indicator for the middle character. Outputs II will deactivate during Fire Service.
- Melina PI display Outputs II (Right)
 - Right Character 9—22: Outputs to the Melina position indicator for the right character. Outputs II will deactivate during Fire Service.
- System Configurations (Simplex)
 - Hall Call Eligibility Config (1 - 8): Output is active when the respective Hall Call Eligibility Configuration (1 - 8) is active.
 - Parking Config (1 - 8): Output is active when the respective Parking Configuration (1 - 8) is active.
 - Parking Eligibility Config (1 - 8): Output is active when the respective Parking Eligibility Configuration (1 - 8) is active.
 - Mode of Operation Config (1 - 8): Output is active when the respective Mode of Operation Configuration (1 - 8) is active.
 - Security Config (1 - 8): Output is active when the respective Security Configuration (1 - 8) is active.
 - CFSS In Use 1 (2):
 - CFSS System 1 (2):
 - Active Mode - Balanced: Output is active when the current dispatching mode is Balanced.
 - Active Mode - Demand Up Peak: Output is active when the current dispatching mode is Demand Up Peak.
 - Active Mode - Demand Down Peak: Output is active when the current dispatching mode is Demand Down Peak.
- Hall Calls - Aux Front Down
 - Hall Call - Aux Front Down Light 1 - 150): Outputs which can be used to drive the Front Auxiliary Down Hall Call lights.
- Hall Calls - Aux Rear Down
 - Hall Call - Aux Rear Down Light (1 - 150): Outputs which can be used to drive the Rear Auxiliary Down Hall Call lights.
- Hall Calls - Main Front Down
 - Hall Call - Main Front Down Light (1 - 150): Outputs which can be used to drive the Front Main Down Hall Call lights.
- Hall Calls - Main Rear Down
 - Hall Call - Main Rear Down Light (1 - 150): Outputs which can be used to drive the Rear Main Down Hall Call lights.
- Hall Calls - Aux Front Up
 - Hall Call - Aux Front Up Light (1 - 150): Outputs which can be used to drive the Front Auxiliary Up Hall Call lights.
- Hall Calls - Aux Rear Up

- Hall Call - Aux Rear Up Light (1 - 150): Outputs which can be used to drive the Rear Auxiliary Up Hall Call lights.
- Hall Calls - Main Front Up
 - Hall Call - Main Front Up Light (1 - 150): Outputs which can be used to drive the Front Main Up Hall Call lights.
- Hall Calls - Main Rear Up
 - Hall Call - Main Rear Up Light (1 - 150): Outputs which can be used to drive the Rear Main Up Hall Call lights.
- CFSS Calls - CFSS 1 Front
 - CFSS Call - CFSS 1 Front Output (1 - 150): Outputs which can be used to drive the CFSS 1 Front Call lights.
- CFSS Calls - CFSS 1 Rear
 - CFSS Call - CFSS 1 Rear Output (1 - 150): Outputs which can be used to drive the CFSS 1 Rear Call lights.
- CFSS Calls - CFSS 2 Front
 - CFSS Call - CFSS 2 Front Output (1 - 150): Outputs which can be used to drive the CFSS 2 Front Call lights.
- CFSS Calls - CFSS 2 Rear
 - CFSS Call - CFSS 2 Rear Output (1 - 150): Outputs which can be used to drive the CFSS 2 Rear Call lights.
- Custom Outputs
 - Toggle Output: The Toggle Output can be used to convert a steady state Custom Output to a toggled output.
 - Custom Out (1 - 20): Allows existing inputs, outputs and internal flags to be combined in a custom logic equation which can then generate a custom output. [Please refer to “Configuration - Advanced - Custom Outputs” on page 9-139.](#)
- Remote User Outputs
 - Remote (01 - 32) Output: User programmable outputs. [Please refer to “Configuration Tabs - Remote Outputs” on page 10-66.](#)
- Heat Detectors
 - Heat Detectors Audible Signal: This normally low output is activated when heat detectors are activated. It is used to operate audible indicator(s).
 - Heat Detectors Visual Signal: This normally low output flashes when heat detectors are activated. It is used to operate visual indicator(s).
 - Heat Detectors Recall Complete: This normally low output is activated when the car has completed the Heat Detectors recall operation (reached a floor - doors are fully open).

Configuration - iBox Configuration

This tab provides detailed information about the iBox and its port address settings (View > Configuration > iBox Configuration).

The screenshot shows the 'iBox Configuration' tab in a web interface. It is divided into several sections:

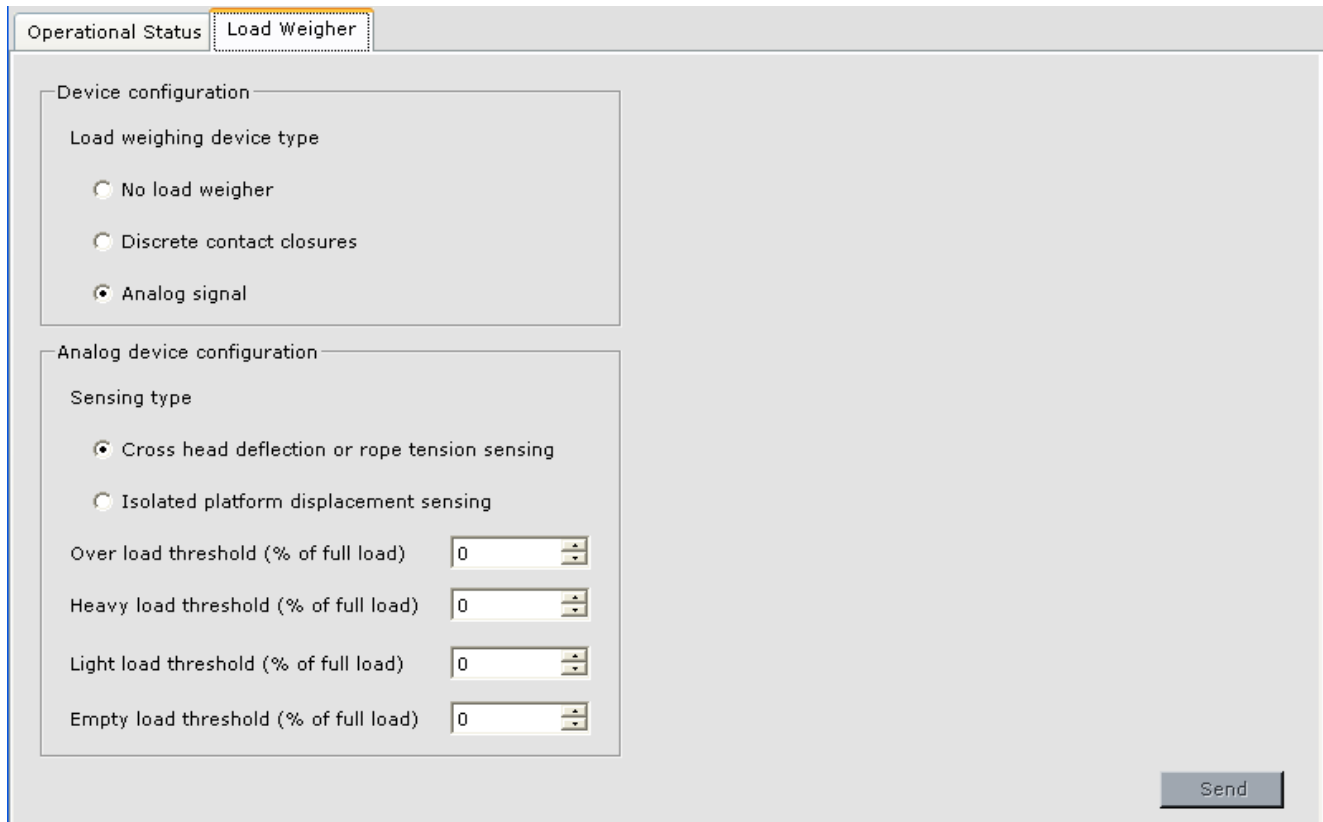
- MAC Addresses:** Three input fields for MAC 1 (0008ea0004e4), MAC 2 (0008ea0004e5), and MAC 3 (0008ea0004e6).
- Version:** Three input fields for Serial number, ICE-IMP, and REV X1.
- Miscellaneous:** Two input fields for Boot flags and Time zone.
- Network Information:** A large section containing three sub-sections:
 - LAN Port:** IP address (10.10.52.10), Subnet (255.255.0.0), Gateway (10.10.254.254), DNS name (MCE0000F1), and DNS server.
 - System Ethernet Port:** IP address (192.168.192.1), Subnet (255.255.255.0), Gateway (0.0.0.0), DNS name (MCE0000F2), and DNS server.
 - PC:** IP address (192.168.193.1), Subnet (255.255.255.0), Gateway (0.0.0.0), DNS name (MCE0000F3), and DNS server.
- Update Status:** A large empty text area for displaying status messages.

A 'Send' button is located at the bottom right of the configuration area.

- **Mac Addresses:** Unique hardware address for each of the iBox Ethernet ports.
- **Version:** iBox and iView version information.
- **Miscellaneous:** Boot flags are used during internal test. Time zone indicates the time zone where the equipment is installed and is used primarily for a monitoring reference.
- **Network Information:** Ethernet information for each of the iBox ports.

Configuration - Loadweigher

The Loadweigher screen configures the controls associated with the load weigher.



Operational Status | Load Weigher

Device configuration

Load weighing device type

- No load weigher
- Discrete contact closures
- Analog signal

Analog device configuration

Sensing type

- Cross head deflection or rope tension sensing
- Isolated platform displacement sensing

Over load threshold (% of full load)

Heavy load threshold (% of full load)

Light load threshold (% of full load)

Empty load threshold (% of full load)

Send

Device configuration

- **Load weighing device type:**
 - **No load weigher:** Select if no load weigher is used.
 - **Discrete contact closures:** Select if your load weigher provides only discrete contact closure information (no analog value).
 - **Analog signal:** Select if your load weigher provides an analog signal corresponding to the weight in the car. This selection will enable the additional parameters below.

Analog device configuration

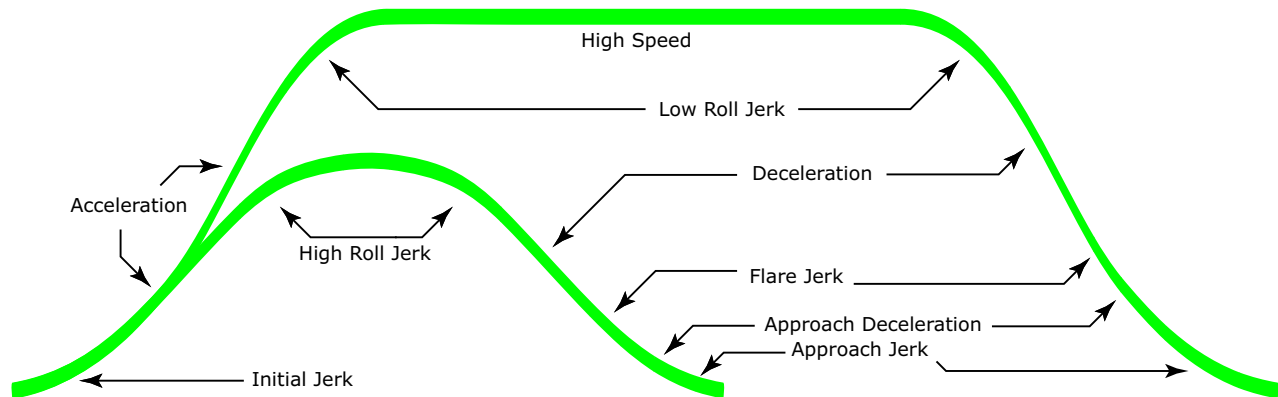
- Sensing type
 - Cross head deflection or rope tension sensing: Select if your load weigher provides an analog signal based on deflection of the elevator cross head or the tension of the wire ropes.
 - Isolated platform displacement sensing (MCE): Select if your load weigher provides an analog signal based on the compression of the pads under the isolated platform in the car.
- Over load threshold (% of full load): When the weight in the car exceeds this threshold the controller will consider the car to be in an over load condition. This value is typically 110% to 115% of full load. [Please refer to “Load Weigher Selection and Threshold Settings” on page 4-32.](#)
- Heavy load threshold (% of full load): When the weight in the car exceeds this threshold the controller will consider the car to be in a heavy load condition (used for hall call bypass). Typically set from 80% to 90% of full load. [Please refer to “Load Weigher Selection and Threshold Settings” on page 4-32.](#)
- Light load threshold (% of full load): When the weight in the car is less than this threshold the controller will consider the car to be in a light load condition. Typically this value is set below 20% of full load. [Please refer to “Load Weigher Selection and Threshold Settings” on page 4-32.](#)
- Empty load threshold (% of full load): When the weight in the car is less than this threshold the controller will consider the car to be empty. Typically less than 10% of full load. [Please refer to “Load Weigher Selection and Threshold Settings” on page 4-32.](#)

Configuration - Pattern

The active Pattern Profile dictates the cars change in velocity as it moves between floors. This includes starting from a stop, accelerating, running at speed, decelerating, and coming to a stop. Adjusting pattern parameters affects the performance of the car (ride comfort, floor-to-floor times, etc.). The larger profile below shows a run long enough for the car to reach contract speed (multi-floor run). The smaller profile shows a short run in which the car did not reach contract speed (i.e., a one-floor run).

From the Configuration > Pattern tab, you can adjust parameters that determine the profile of the patterns used by the system in its various operating modes. The illustration below shows a pattern with adjustment points called out.

Figure 9.2 Pattern Profile Adjustment Points



The patterns use by iControl include:

- **Standard:** Profile used for normal passenger operation.
- **Earthquake:** Profile used when the Earthquake (EQI) input is activated.
- **Emergency power:** Profile is used when the Emergency Power Input (EPI) is activated.
- **Emergency slowdown:** Profile used when faster than normal deceleration is required, e.g. overspeed at a Normal Terminal Switch or loss of quadrature (positioning) signal. (Does not have a High Speed parameter setting.)
- **Correction:** Profile used when the system is not confident of car hoistway position. The car proceeds to a known position using the Correction Profile in order to synchronize its position information.
- **Inspection:** Profile used when the elevator is on Inspection operation. (Has two additional parameters.)
- **Alternate 1:** Profile used when the Alternate Speed Profile One (ASP1) Input is activated.
- **Alternate 2:** Profile used when the Alternate Speed Profile Two (ASP2) Input is activated.

The Pattern > Common tab, sets parameters that apply to all profiles. The parameters that shape the various patterns are adjusted on the Pattern > Modes tab.

Pattern - Common Tab

The Pattern > Common tab parameters apply to all pattern profiles.

The screenshot shows the 'Pattern - Common Tab' configuration window. At the top, there are tabs for 'Operational Status' and 'Pattern'. Below that, there are sub-tabs for 'Common' and 'Modes'. The 'Common' tab is active and contains the following sections:

- General:**
 - Position Encoder resolution: 256.00 pulses/ft
 - Pattern scaling: 100.00 %
 - Door pre-opening distance: 5.00 in
- Position synchronization:**
 - Terminal:
 - Floor:
 - Preset:
- Leveling:**
 - Leveling speed: 3.96 ft/min
 - Releveling speed: 3.96 ft/min
 - Leveling distance: 0.19 in
 - Releveling distance: 0.50 in
- Dead zone:**
 - Dead zone distance: 0.25 in
 - Relevel dead zone distance: 0.15 in

General

- **Position encoder resolution:** Used to set the position encoder resolution. 256, the resolution used by iLand, is currently the only valid setting.
- **Pattern scaling:** Scaling factor applied to all programmed speeds. This is used during adjustment to move the car slowly to verify drive operation, etc. May be set from 0 to 150%. At 0%, no pattern command output voltage is produced so the car should not move. At 100%, the car will move at the high speed set for the selected operating mode.
- **Door pre-opening distance:** When set, this is the distance from the final floor position at which door pre-opening is initiated. If no distance is set, door pre-opening is disabled.

Leveling These parameters apply to leveling speed and distance:

- Leveling speed: Determines the speed at which the elevator will level into the floor (initial approach prior to normal rate limited stop). [Please refer to “Final Stop” on page 4-26.](#)
- Releveling speed: Determines the speed used during releveling, prior to normal rate limited stop. Releveling occurs after the car has reached a floor and subsequently is required to relevel (direction enabled with ULM or DLM active). *See also:* Relevel distance and Relevel dead zone distance.
- Leveling distance: Determines the distance from the final floor position at which the elevator operates at leveling speed.
- Releveling distance: The car must perform a re-level operation if it stops further than this distance from the floor (with ULM or DLM active) or if, after stopping, moves further than this distance from the floor due to load change.

Dead zone These parameters define a zone in which, or a distance from a floor at which, an action may occur. [Please refer to “Final Stop” on page 4-26](#)

- Dead zone distance: The distance from the final floor position where the stop command is issued (transition from leveling speed to normal rate limited stop) on the initial run to the floor (i.e., leveling operation).
- Re-level dead zone distance: The distance from the final floor position where the stop command is issued (transition from re-level speed to normal rate limited stop) during a relevel operation. [Please refer to “Releveling Operation” on page 4-29.](#)

Position Synchronization When the elevator encounters floor magnets or a terminal switch, the encounter is reported to the controller. The controller can use the learned position of the magnets or switch to update the current position reported by the position encoder. Position Synchronization buttons allow you to force the controller to synchronize its position to floor magnets or the bottom landing of the building (the controller 0.00 position).

- Terminal: Forces the controller to synchronize its position with a terminal landing. The controller will use iLand reported position to choose to synchronize with an upper or lower terminal landing. The car will travel at a rate halfway between Contract and Correction Speed to the selected terminal. Upon reaching the first terminal switch, the car will decelerate to Correction Speed. At the final terminal switch, the car will decelerate to leveling speed, synchronize its position, and return to normal operation. The on-screen Terminal “LED” lights during synchronization.
- Floor: Forces the controller to synchronize its position with the current or nearest floor magnets. The car will rise just enough to register the falling edge of the magnet-induced signal, then resettle to the floor and synchronize its position. (The controller anticipates, based on its logical position in the hoistway, that the signal should be encountered within a calculated number of inches. If this calculation proves false, the elevator will stop at the next floor.)
- Preset: Not implemented.

Typical Common Tab Settings

The settings in the table below are typical for a 500 feet per minute installation.

Table 9.8 Typical Common Tab Settings

Parameter	Value
Position Encoder resolution	256 (iLand, normal installation)
Pattern scaling	100%
Door preopening distance	3.0
Leveling speed	4.0
Releveling speed	4.0
Leveling distance	0.2
Releveling distance	0.3
Dead zone distance	0.2
Relevel dead zone distance	0.1

Pattern - Modes Tab

The parameters that shape the various patterns are adjusted on the Pattern > Modes tab. Click a parameter name (top row) or parameter value to see the portion of the profile adjusted by that parameter. Click a pattern name (left column) to highlight the parameters used by that pattern.

Operational Status
Safety
Pattern

Common
Modes

Profiles

	Initial jerk	Acceleration	High roll jerk	High speed	Low roll jerk	Deceleration	Flare jerk	Approach deceleration	Approach jerk	Low speed
Standard	6.000	3.000	6.000	500.000	4.000	3.000	2.000	1.500	2.000	
Earthquake	6.000	2.000	6.000	150.000	4.000	2.000	2.000	1.000	2.000	
Emergency power	6.000	3.000	6.000	500.000	4.000	3.000	2.000	1.500	2.000	
Emergency slowdown	25.000	6.000	25.000	500.000	25.000	6.000	15.000	3.000	10.000	
Correction	6.000	1.000	6.000	50.000	6.000	1.000	2.000	0.500	2.000	
Inspection	6.000	1.000	6.000	50.000	6.000	1.000	2.000	0.500	2.000	25.000
Alternate 1	6.000	3.000	6.000	500.000	4.000	3.000	2.000	1.500	2.000	
Alternate 2	6.000	3.000	6.000	500.000	4.000	3.000	2.000	1.500	2.000	

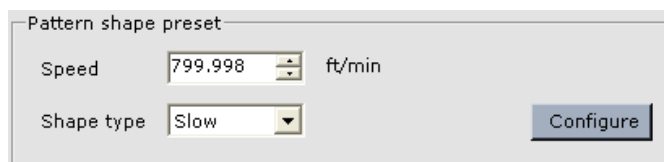
Reduced inspection speed

Pattern Profile parameters

- **Initial jerk:** The transition from zero speed to full acceleration. As Initial jerk is increased, the profile transitions more quickly from starting acceleration to maximum acceleration.
- **Acceleration:** Determines the maximum acceleration for this profile.
- **High roll jerk:** Used when the car is not able to reach High speed. Determines how quickly the profile transitions from maximum to zero acceleration and zero to maximum deceleration.
- **High speed:** Determines the maximum speed for this profile. (For the Standard profile this is usually contract speed.)
- **Low roll jerk:** Used when the car is able to reach High speed. Determines how quickly the profile transitions from maximum to zero acceleration and zero to maximum deceleration.
- **Deceleration:** Determines the maximum deceleration for this profile.
- **Flare jerk:** The transition from maximum deceleration to Approach deceleration. As Flare jerk is increased, the profile transitions more quickly.
- **Approach deceleration:** Determines the deceleration rate for the transition from Flare jerk to Approach Jerk.
- **Approach jerk:** The transition from approach Deceleration to leveling speed. As Approach Jerk is increased, the profile transitions more quickly.
- **Low speed:** The Low speed parameter is used only in Inspection mode. It determines the reduced speed to which the car will decelerate after encountering a DNT5 or UNT5 switch when operating in Inspection mode. (For example, if Inspection - High speed were set to 50 feet per minute and Low speed to 20 feet per minute, the car would decelerate from 50 fpm to 20 fpm if a terminal switch was encountered during Inspection operation.) Active only when the Reduced inspection speed option is enabled.
- **Reduced inspection speed:** Specifies that the car, when in Inspection mode, will decelerate to the Low speed setting if a DNT5 or UNT5 switch is opened.

Pattern shape preset Pattern shape preset can be used to enter preset values for the profile parameters based on the high speed (contract speed) of the elevator and the selected shape type.

1. **Speed:** Enter the high speed (contract speed of the elevator).
2. **Shape type:** Select the desired shape type.
 - **Slow:** Slow floor to floor times with gentle transitions.
 - **Moderate:** Moderate floor to floor times with moderate transitions.
 - **Fast:** Fast floor to floor times with aggressive transitions.
3. Click **Configure**. Preset values for the pattern profile parameters are entered.



To edit parameters

1. Click in the cell where the parameter is located.
2. Use the up / down arrow buttons or highlight the value and type a new value.
3. Acquire write privilege (click *Acquire* on the Write privilege menu). Press the YES soft-key on the iBox.
4. Click *Send* to send the new value to iControl.

Typical Pattern Values Typical values for a 500 feet per minute installation are shown in the following table. Alternate 1 and 2 values depend completely on the behavior desired when the elevator is operating under control of those patterns (there really are no “typical” settings for Alt 1 and Alt 2).

Typical Pattern Settings (500 FPM Installation)

Operational Status		Pattern									
Common		Modes									
Profiles											
	Initial jerk	Acceleration	High roll jerk	High speed	Low roll jerk	Deceleration	Flare jerk	Approach deceleration	Approach jerk	Low speed	
Standard	4.000	3.500	4.000	500.000	4.000	3.000	2.500	1.250	1.000		
Earthquake	7.000	2.000	7.000	150.000	5.000	2.000	3.000	1.000	2.000		
Emergency power	3.000	3.000	4.000	500.000	4.000	3.500	3.500	1.250	1.250		
Emergency slowdown	10.000	6.000	15.000	500.000	10.000	6.000	6.000	2.250	6.000		
Correction	7.000	1.000	7.000	100.000	7.000	1.000	6.000	1.500	2.000		
Inspection	3.000	1.000	3.000	50.000	3.000	1.000	3.000	1.500	2.000	25.000	
Alternate 1	7.000	3.000	7.000	500.000	5.000	3.000	3.000	1.500	2.000		
Alternate 2	7.000	3.000	7.000	500.000	5.000	3.000	3.000	1.500	2.000		

Send

Configuration - Terminal Switches

The Configuration > Terminal Switches tab displays the position margins for the normal and emergency terminal switches plus the Overspeed 1 percentage.

- **Margin:** The position of the Normal and Emergency Terminal switches is learned using the Terminal Learn procedure (Please refer to “Learning Normal & Emergency Terminal Limit Switches” on page 4-9). The margin settings determines the variance from the learned position required to generate an Up (or Down) Normal Terminal Switch ‘n’ Position Fault or an Up (or Down) Emergency Terminal Switch Position Fault (n = 1 to 5).
- **Overspeed 1:** Determines the percentage of variance from the learned speed required to generate an Up (or Down) Normal Terminal Switch ‘n’ Level 1 Speed Fault (n = 1 to 5). The “learned” speed is learned using the Terminal Learn procedure (Please refer to “Learning Normal & Emergency Terminal Limit Switches” on page 4-9).

Operational Status
Terminal Switches

Margin

	Position (ft)
UNT 5	2.000
UNT 4	2.000
UNT 3	2.000
UNT 2	2.000
UETS	2.000
UNT 1	2.000
DNT 1	2.000
DETS	2.000
DNT 2	2.000
DNT 3	2.000
DNT 4	2.000
DNT 5	2.000

Over speed 1 %

Configuration - Timer Tables (Controller)

The Controller > Configuration tab allows you to create timers that automatically determine, based on day and time of day, the status (On or off) of Auto Stop, Sabbath operation and Swing operation.



System timer tables can be used to determine the currently active configuration for Hall Call Eligibility, Parking, Parking Eligibility, Mode of Operation, Security and the state for User Outputs 1 through 4. Please refer to “Configuration Tabs - Timer Tables (System)” on page 10-62.

	Timer Name	Configuration
1	Auto Stop Weekdays	On
2	Auto Stop Weekends	On
3		
4		
5		
6		
7		
8		
9		
10		
11		

Timer Details

Recurrence Type: Weekly Date Recurrence
 Start: 12:00 AM
 End: 12:00 AM
 Pattern: Every Saturday Thru Sunday

Features

The timers associated with the type of operation selected in Features are displayed in the Timers list. For example, in the screen above, Auto Stop is selected and the timers that automatically determine the state of Auto Stop are displayed. Timers may be displayed for:

- Auto Stop
- Sabbath Operation
- Swing

Timer Details

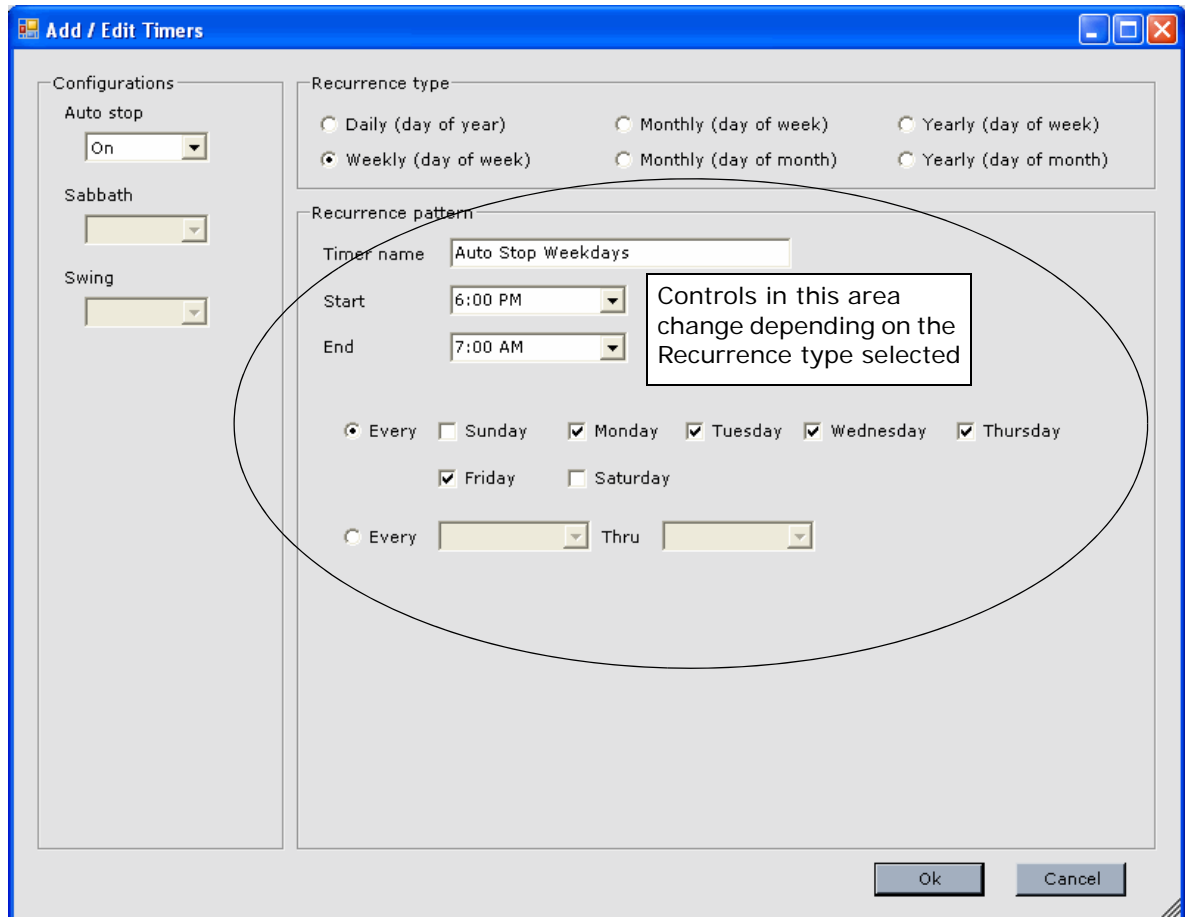
When a timer is selected in the table, details of its settings appear in Timer Details. (You must select a timer and click Edit to change settings. This display is read only.)

Timers

Timers are displayed in the Timers list. If timers overlap (manage the same period of time), the timer appearing higher in the list will have priority (control). To move a timer within the list, click to select it, then click Move Up or Move Down.

Add a Timer To add a new timer to the list:

1. Click Add. The Add/Edit Timer dialog is displayed.



2. From the Configurations list, select the configuration(s) and/or feature(s) that should be active when this timer is valid (timer day and time are the present day and time).
3. Select the repeat frequency (Recurrence type) of the timer:
 - **Daily:** This timer is active every day during the specified time period.
 - **Weekly (Day of the week):** This timer is active each week on the specified day or days (i.e., Mondays or Mondays and Tuesdays) or can be set to span days (i.e., Monday through Wednesday).
 - **Monthly (Day of week):** This timer is active each month on the specified week days (i.e., first Monday, third Sunday, etc.) or can be set to span days (i.e., second Sunday through third Saturday, etc.).

- Monthly (Day of month): This timer is active each month during the specified time period, on the specified date or dates or may be set to span dates.
 - Yearly (Day of week): This timer is active each year during the specified time period, during the specified month or months, on the specified day or days or may be set to span days across multiple months.
 - Yearly (Day of month): This timer is active each year during the specified time period, during the specified month or months, on the specified date or dates or may be set to span dates across multiple months.
4. Enter the timer details using the Recurrence pattern controls. (These controls change depending on the Recurrence type selected.)
 - Enter a descriptive name for the timer (up to 25 characters).
 - Select the start and end time, day(s) or date information required.
 5. Click OK.
 6. Click Send to send new or changed timer information to iControl.

To remove a timer

1. Select a configuration/feature type from the Features drop down list.
2. Select a timer from the Timers list.
3. Click Remove.

To edit a timer

1. Select a configuration/feature type from the Features drop down list.
2. Select a timer from the Timers list.
3. Click Edit.
4. Make changes using the Add/Edit Timers dialog.
5. Click OK.

To move a timer A timer's position in the list determines its priority. If two timers are attempting to control the same configuration at the same time, the timer higher in the list (lower Priority number) will have control. To move a timer:

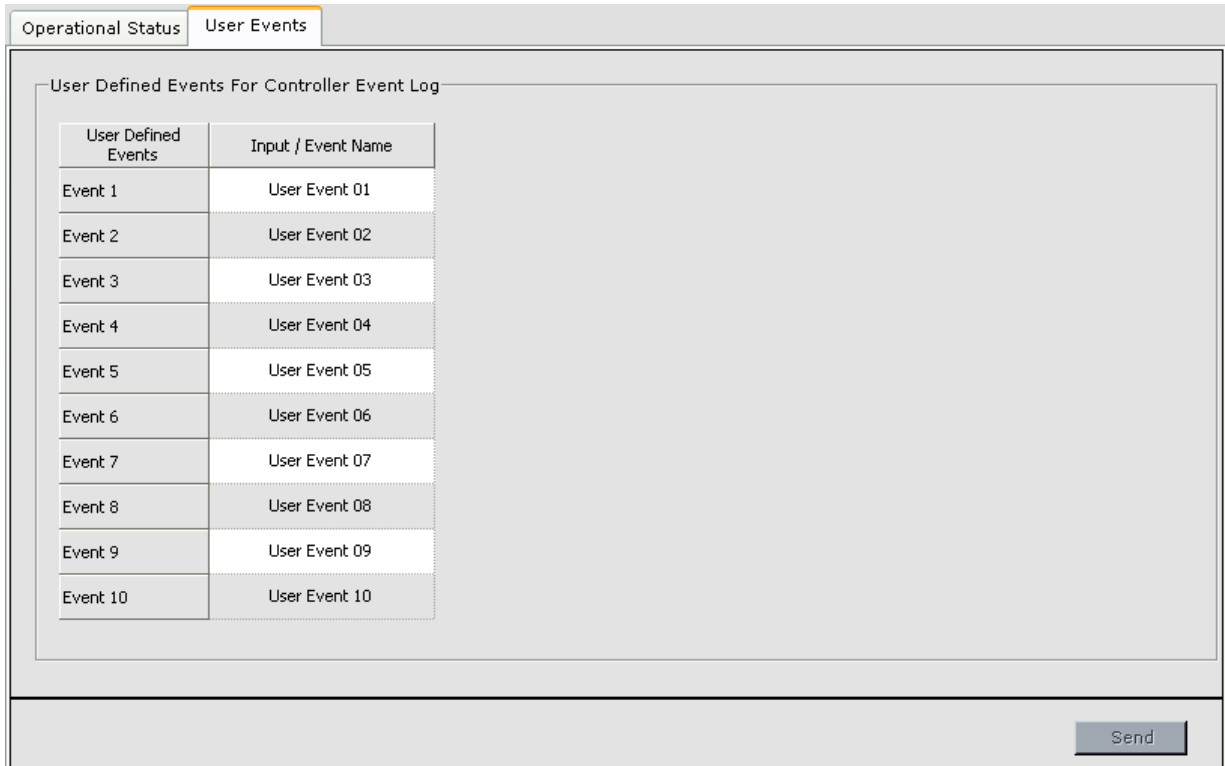
1. Select the timer from the Timers list.
2. Click Move Up or Move Down.

Note

No valid timer: For a particular configuration/feature, i.e., Auto Stop, Sabbath Operation, etc., if Timed is selected and there is no valid timer (current date and time falls within the timer's date(s) and times), those configurations/features will default to their #1 configuration or default state.

Configuration - Advanced - User Events

The User Events tab is used to assign a name to an *Input / User Event*. Up to 10 Input / Event Names can be programmed. This event name can then be assigned to a hardware input. An event is logged, on the Controller Event Log, when the input is activated and again when it is deactivated. Controller - Input / Event Names are assigned to terminals on an ICE-MIAC Multiple Input AC board using the Controller > Configuration > I/O Boards tab. For information about System User Events see [“Configuration Tabs - User Events” on page 10-65](#)



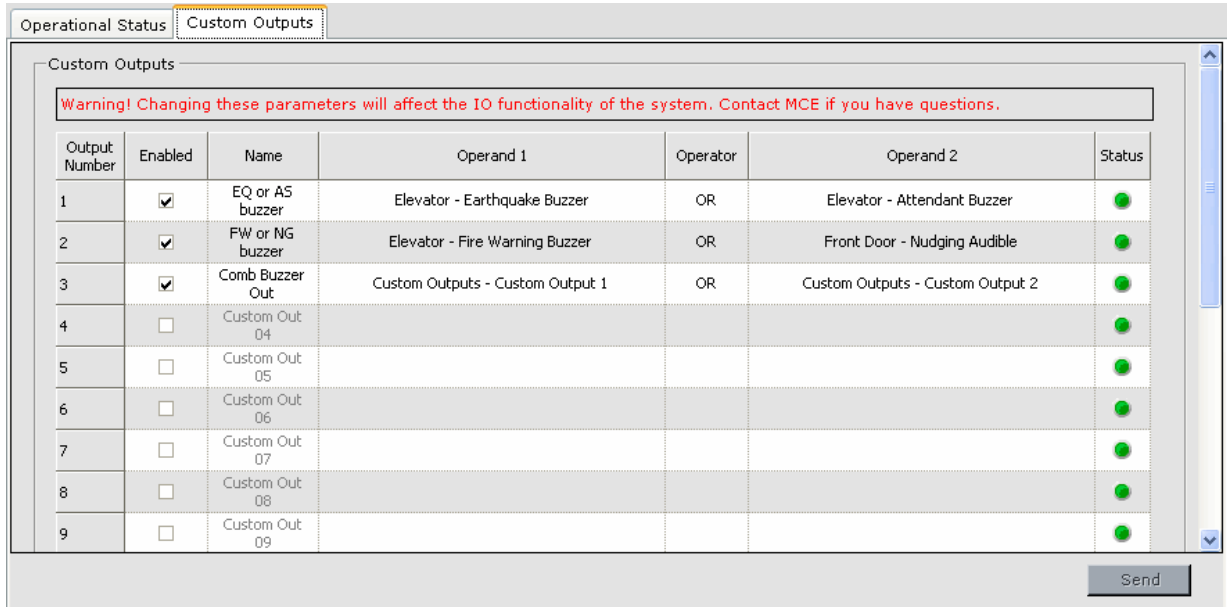
User Defined Events	Input / Event Name
Event 1	User Event 01
Event 2	User Event 02
Event 3	User Event 03
Event 4	User Event 04
Event 5	User Event 05
Event 6	User Event 06
Event 7	User Event 07
Event 8	User Event 08
Event 9	User Event 09
Event 10	User Event 10

To configure a Controller User Event:

1. Display the User Events tab (Controller > Configuration > Advanced > User Events tab).
2. Enter the desired *Input / Event Name*, up to 40 characters.
3. *Send* the Input / Event name to the controller. The name will then appear under *User-Defined Events* on the list of inputs used to configure the I/O Boards.
4. Assign the event to a terminal on an ICE-MIAC Multiple Input AC Board using the Controller > Configuration > I/O Board tab (see [“Configuration - I/O Boards” on page 9-100](#)). User Events can also be assigned to terminals on an ICE-COP Serial Car Operating Panel Board.

Configuration - Advanced - Custom Outputs

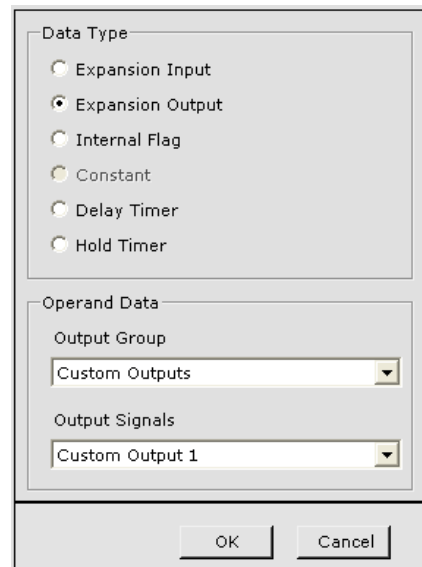
The custom outputs feature allows existing inputs, outputs and internal flags to be combined in a custom logic equation which can then generate a custom output which can be assigned to an output terminal on an ICE-MOR or ICE-COP board.



In the simple example above, the Earthquake Buzzer, Attendant Buzzer, Fire Warning Buzzer and Nudging Audible outputs are OR'ed into one Combined Buzzer Output, which is then assigned to a terminal on an ICE-MOR board.

To program a custom output Custom outputs are programmed as follows:

1. Check the Enabled box to enable a line of the logic equation.
2. The Name of the output or flag can be customized, up to 16 characters can be used.
3. Click the Operand 1 cell and click the arrow. Use the dialog box to select the Data Type and Operand Data. Then click OK. The appropriate information is placed in the logic table.
4. Click the Operator cell, click the arrow and select an operator (NOT, AND, OR, XOR, NAND).
5. Click the Operand 2 cell and click the arrow. Use the dialog box to select the Data Type and Operand Data as in step 3.
6. Acquire Write privilege and Send the data to iControl.
7. The Status LED turns on when the logic statement is true.
8. Once the logic equation is complete, you can assign the custom output to a terminal using the I/O Boards tab. [Please refer to "Configuration - I/O Boards" on page 9-100.](#) Outputs can be programmed for an ICE-MOR board or for an ICE-COP board.

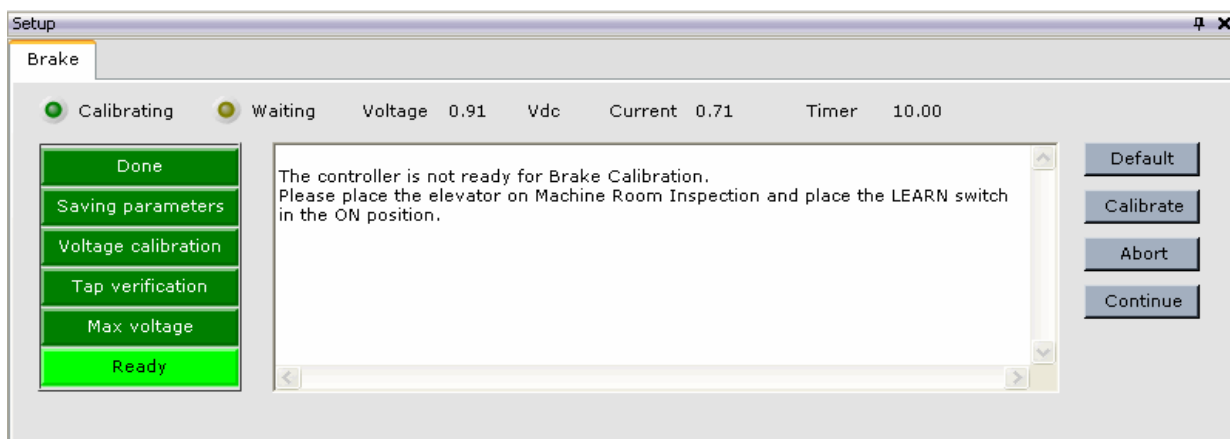


Controller - Setup Tabs

The Setup tabs allow you to perform various setup and calibration procedures. Typically these procedures require observation or manipulation of parameters contained on the associated Configuration tab. Screen layouts have been created that display both the configuration and the setup tab. Therefore, when performing a setup procedure, it is recommend to use the layout display, e.g. when performing the Brake Calibration, use the Brake layout (View > Layouts > Brake).

Setup - Brake Tab

The Setup > Brake tab allows you to perform the brake calibration procedure. When performing this procedure it is recommend to display the Brake Layout (View > Layout > Brake)

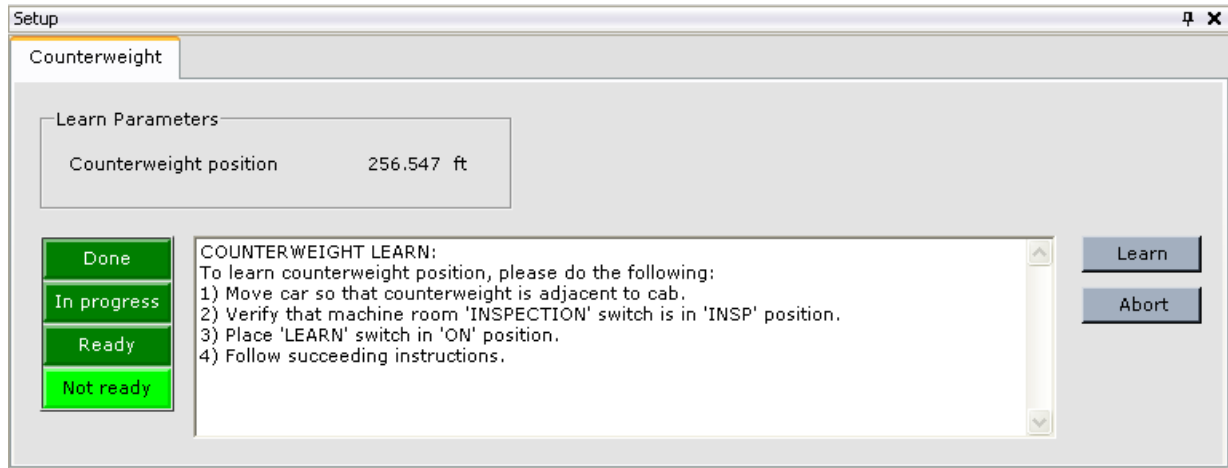


- Indicators: The *Calibrating*, *Waiting*, and *progress indicators* track and report progress through Brake Calibration phases.
- Message window: Provides feedback and instructions during Brake Calibration.
- Default button: Sets brake parameters to the default values.
- Calibrate button: Starts the Brake Calibration procedure using voltage and timer values entered.
- Abort button: Aborts the Brake Calibration procedure.
- Continue button: Restarts the Brake Calibration procedure if it has paused to allow completion of an instruction displayed in the message window.

The brake calibration procedure is described in Section 2 of this manual. [Please refer to “Drive Offsets Calibration” on page 2-48.](#)

Setup - Counterweight Tab

Used to first learn, then display the learned position in the hoistway where the car and counterweight are adjacent to each other. iControl uses this information to make logic decisions requiring knowledge of counterweight position in relation to the car (i.e., Earthquake operation mode decisions).



- **Counterweight Position:** The distance, in feet, between the car and the lowest floor served by the elevator when the counterweight learn operation was accomplished. The learn operation is performed with the car and counterweight at the same height in the hoistway (adjacent to one another). [Please refer to “Counterweight Learn Procedure” on page 3-28.](#)



Setup - Drive Tab

Used to calibrate the Input ADC and Output DAC offsets. [Please refer to “Automated Drive Setup Procedure” on page 2-48.](#)

Operational Status | Drive

General | Safety | Control | Filters | Dampening | Pre-Torque | Calibration

Setup

Drive

To perform drive offsets calibration, please do the following:

- 1) Obtain 'Write Privilege'.
- 2) Verify machine room 'INSPECTION' switch is in 'INSP' position.
- 3) Toggle 'LEARN' switch to 'ON' position.
- 4) Follow succeeding instructions.

Calibration Status

	Input ADC	Output DAC	Current sensor	Current loop integral
Inactive	●	●	●	●
Idle	●	●	●	●
N/A	●	●	●	●
Calibrating	●	●	●	●
Internal error	●	●	●	●
Threshold error	●	●	●	●
Calibrated	●	●	●	●
Saved	●	●	●	●

Calibration Data

Current loop integral	0.000
Current sensor	0.000
Output DAC	0.000

Input ADC

Tachometer	0
Brake current	0
Brake voltage	0
Motor field weakening	0
Armature current	0
Armature voltage	0
Abs armature current	0
Motor field current	0
Motor field voltage	0
AC phase A current	0
AC phase B current	0
AC phase C current	0

9-142 Manual # 42-02-2222

Contents

Index

MCE Web

Setup - Floor Heights - Learn Tab

The Setup > Floor Heights > Learn tab is used to perform the Floor Heights Learn procedure. Please refer to “Learning the Floor Heights” on page 4-2. When performing this procedure it is best to use the Floor Heights layout (View > Layouts> Floor Heights) which displays both the Floor heights setup and Floor Heights configuration tabs. While performing the learn procedure, the current car position and speed can be viewed in the Hoistway window. The results of this calibration can be viewed on the Configuration > Floor Heights > Configurations tab. Please refer to “Configuration - Floor Heights” on page 9-94.

Setup

Floor Heights

Learn | Floor Offsets

Configuration data

	Learned	Saved
Floors	0	60
Front markers	0	0
Landings	0	60
Rear markers	0	0
Openings	0	60

Edge data

Leveling markers	Front		Rear	
	Error	Count	Error	Count
Top level up	0	0	0	0
Top level down	0	0	0	0
Bottom level up	0	0	0	0
Bottom level Down	0	0	0	0

Learn metrics

Floor		
Height	0	ft
Last floor height	0	ft

Leveling sensor

Front	Rear
<input checked="" type="radio"/> Up leveling marker	<input checked="" type="radio"/> Up leveling marker
<input checked="" type="radio"/> Door zone	<input checked="" type="radio"/> Door zone
<input checked="" type="radio"/> Down leveling marker	<input checked="" type="radio"/> Down leveling marker

Outer level

Velocity	0.000	ft/min
Error	0.000	ft

Learn

Type

Manual

Auto

Status

Front: Waiting for learn request

Rear: Waiting for learn request

Done

In progress

Ready

Not ready

To learn floor heights, please do the following:

- Obtain 'Write Privilege'.
- Place machine room 'INSPECTION' switch in 'INSP' position.
- Move car onto down directional limit.
- Verify that 'UNTD' input is 'ON'.
- Verify that 'DNTD' input is 'OFF'.
- Verify that 'ULM' input is 'ON'.

Learn

Abort

The Setup > Floor Heights > Learn tab contains:

Configuration data Learned and actual (previously saved) data detected by the Floor Heights Learn procedure.

- Floors - the top floor configured on the Configuration > General > Floor data tab.
- Front markers - the number of front landing magnets detected.
- Landings - the number of floors where a front and/or rear landing magnet was detected (includes false floors).
- Rear markers - the number of rear landing magnets detected.
- Openings - the number of floors with eligible openings (front and/or rear) per the Configuration > General > Floor data tab.

Edge data Used for diagnosing possible problems with floor magnets and magnet detection.

- Error - the difference between the height learned by the Floor Heights Learn procedure and the height currently detected by the Top level up, Top level down, Bottom level up and Bottom level down sensors for the front and/or rear landing magnets.
- Count - the number of times each landing system leveling sensor has detected a front or rear landing magnet at the floor.

Learn metrics

- Floor - during the Floor Heights Learn operation, indicates the most recently learned floor.
- Height - the learned height for the floor most recently learned floor.
- Last floor height - the incremental distance to the previously learned floor (difference between the heights learned for the previous and most recently learned floors).

Leveling Sensor Indicates the current state (activated or deactivated) of the front and rear Up leveling marker, Door zone and Down leveling marker sensors.

Outer level

- Velocity - the car speed at the time the last landing magnet edge was detected.
- Error - the difference between the learned and most recent car position when the last landing magnet edge was detected.

Learn Follow the instructions in the message window to perform the learn procedure.

- Type - Manual / Auto. Manual uses iBox switches. Auto runs automatically.
- Status - The following status messages can be displayed:

• Waiting for learn request	Waiting for proper start location
• Idle	Invalid floor sensor transition
• Acquiring floor markers	Acquired floor markers fewer than configuration
• Learned	Acquired floor markers more than configuration
• Saved	Configured floor markers more than maximum allowed
•	Acquired floor marker heights mismatch configuration

Setup - Floor Heights - Floor Offsets Tab

Used to perform the floor offset calibration procedure. Please refer to “Calibrating the Floor Offsets” on page 4-23.

Calibration Status

	Floor offset calibration		Detected in	Measured in	Actual in	Acquired
Inactive	●	8	0.00			●
Pending	●	7	0.00			●
At start floor	●	6	0.00			●
Detecting floor	●	5	0.00			●
Detecting offset	●	M	0.00			●
Bypassing floor	●	L	0.00			●
Offset detected	●	B	0.00			●
Offsets detected	●	SB	0.00			●

Floor Offset Landing

Landing Start landing

Floor offset landing

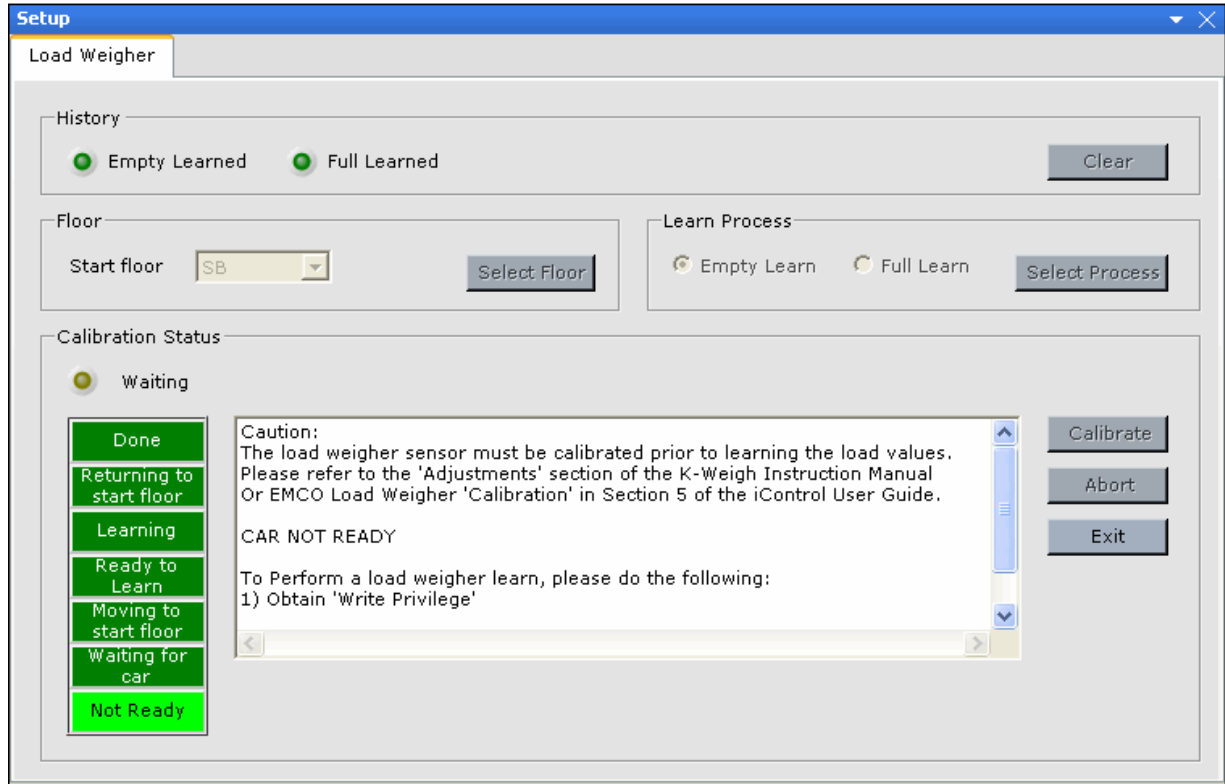
- Landing: The car’s current landing location.
- Start landing: The landing where the floor offset calibration procedure was started.

Offsets

- Detected in: The detected variance between the car’s current location (position in the hoistway) and the learned position of the landing magnet.
- Measured in: The measured distance in decimal inches between the hoistway landing sill and the car sill. Enter a minus (-) value if the car sill was above the landing sill or a plus (+) value if the car sill was below the landing sill.
- Actual in: The calculated floor offset. Once the measured values are entered and sent to the iController, this value will appear on the Configuration > Floor Heights > Floor Offset tab.
- Acquired light: Lights to indicate that the Detected in value has been acquired and it is OK to measure and record the distance between the landing sill and the car sill.

Setup - Load Weigher Tab

Used to perform the load weigher learn procedure. [Please refer to “Load Weigher Learn Procedure” on page 4-34.](#)



Setup - Safety - Configuration Tab

The Safety Setup - Configuration tab defines an installation for the safety processors, letting them know what to monitor. It is also used to perform the safety comparison learn operation. If the safety parameters are changed, the learn process must be completed.

Configuration

- **Pulses per foot:** Displays the pulses per foot value sent by the position encoder (iLand).
- **Contract speed:** Displays the contract speed for the elevator in feet per minute.
- **Overspeed 1 margin:** Displays the Overspeed 1 margin which is set on the Configuration > Terminal Switches tab. The default value is 8% and should not need to be adjusted. If a car exceeds the Overspeed 1 threshold when a Normal Terminal switch opens, it will be brought to a stop using the Emergency slowdown profile settings. The Overspeed 1 threshold = Learned speed at the switch + Overspeed 1 margin.
- **Contract overspeed:** Allows you to set the contract overspeed limit at which an overspeed fault will be generated and the car will be brought to an Emergency Stop.
- **Inspection overspeed:** Allows you to set the inspection overspeed limit at which a car in inspection mode is deemed to be traveling too fast and must be brought to an Emergency Stop.
- **Leveling overspeed:** Allows you to set the leveling overspeed limit at which a car approaching a destination floor will be deemed to be traveling too fast and must be brought to an Emergency Stop.

Selections made here let iControl know exactly what safety inputs are used on the installation. On start-up, iControl checks the state of the monitored inputs to determine the status of the safety configuration.

- **Top access landing:** Select if the installation has a top hoistway access floor. If selected, the door lock and door closed contacts (if applicable) for the associated hoistway door must be wired to the DLAT and DCAT iBox inputs, respectively.
- **Top access rear:** Select if the top access door is a rear door.
- **Bottom access landing:** Select if the installation has a bottom hoistway access floor. If selected, the door lock and door closed contacts (if applicable) for the associated hoistway door must be wired to the DLAB and DCAB iBox inputs, respectively.
- **Bottom access rear:** Select if the bottom access door is a rear door.
- **No intermediate front door locks:** Select if the installation has no door lock contacts wired to the DLMS iBox input. Door lock contacts that should be wired to the DLMS input are front opening hoistway door locks at floors other than the Access floors. Used if all existing front door lock contacts are wired to Access landing inputs (DLAT, DLAB).
- **No intermediate rear door locks:** Select if the installation has no door lock contacts wired to the DLMS-R iBox Rear Door Expansion board (ICE-IRD) input. Door lock contacts that should be wired to the DLMS-R input are rear opening hoistway door locks at floors other than the Access floors. This option used if all existing rear door lock contacts are wired to Access landing inputs (DLAT, DLAB).
- **Front door closed contact:** Select if the installation has a front door closed contact string wired to the DCMS iBox input, or to DCAT or DCAB.
- **Rear door closed contact:** Select if the installation has a rear door closed contact string wired to the DCMS-R iBox Rear Door Expansion Board (ICE-IRD) input, or to DCAT or DCAB.
- **Rear doors:** Select if the car has rear doors.
- **Freight door option 1:** Not implemented.
- **Car top exit:** Select if the car has a top emergency hatch wired to the SP1 iBox input. Wiring the top emergency hatch to the SP1 input is required when the elevator safety code

allows the car to operate with this hatch open during earthquake operation (e.g., ASME A17.1 allows this). Otherwise, the top emergency hatch should be wired in series with other car-mounted safety device contacts, and this option should not be selected.

- **Construction mode:** Select if the car is to operate in construction mode only. [Please refer to “Overview of Construction Mode” on page 2-2](#) for important information about fault generation and required connections unique to construction mode operation.
- **Door position monitor:** Select if the car has a door position monitor contact wired to the iBox DPM input.
- **In car panel inspection:** Select if the car has an in-car inspection switch wired to the iBox INCP input.
- **Bypass switch option:** Factory-enabled/disabled only. Enables/disables the Car and Hoistway Door Bypass switches on the iBox. This option is factory-set in accordance with applicable jurisdictional requirements.

Emergency Brake Use these parameters if the car has an emergency brake to indicate the type of brake and other brake related parameter settings.

Emergency brake: Select if the car has an emergency brake

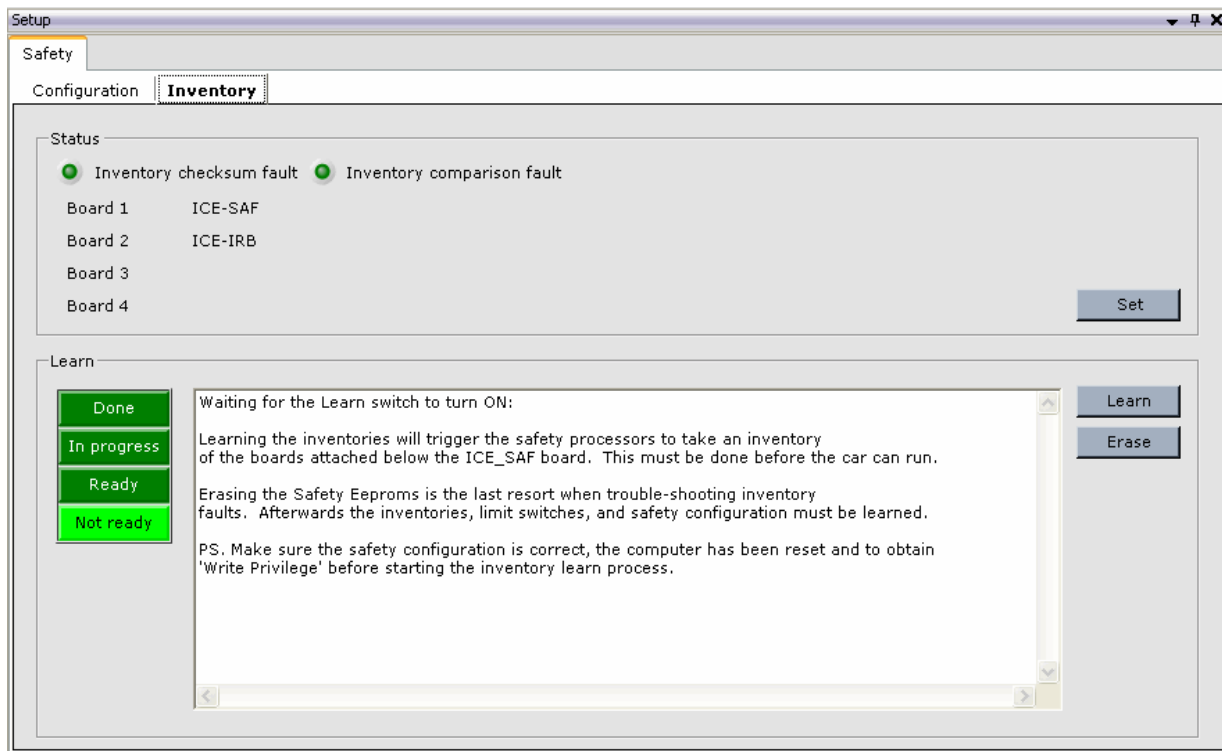
- **Rope gripper:** Select if the installation uses a rope gripper (emergency braking device) wired to the iBox Rope Gripper Board (ICE-RG) connections.
- **Sheave brake:** Select if the installation uses a sheave brake (emergency braking device) wired to the iBox Emergency Brake Board (ICE-EB) connections.
 - **Normal drop delay:** On normal (Passenger) operation, after the M-contactor drops, this delay will expire before the sheave brake drops.
 - **Inspection drop delay:** On Inspection operation, after the M-contactor drops, this delay will expire before the sheave brake drops.
- **Monitor cartop and car panel inspection inputs:** Provides monitoring of cartop and car panel inspection inputs required for TSSA certification.

Learn

Used to perform the safety comparison. The safety configuration of the job is stored in two locations in iControl. iControl constantly checks current safety information against stored data and also compares the data in the two stored locations to make certain they continue to match. If you make a change on the Safety screen, you will need to do a “learn” operation to write the new data to iControl. The controller is set to match the installation safety configuration, according to the job survey, before being shipped. By default, Construction Mode is enabled before the controller is shipped. You should not have to make changes to the Safety tab until taking the car out of Construction Mode. [Please refer to “Learning the Safety Configuration” on page 2-46.](#)

Setup - Safety - Inventory Tab

The Inventory tab is used to perform the Safety Inventory Learn procedure. This procedure must be performed when an inventory fault is generated.



Status The status section provides fault indicators and a list of known safety boards attached to the iBox.

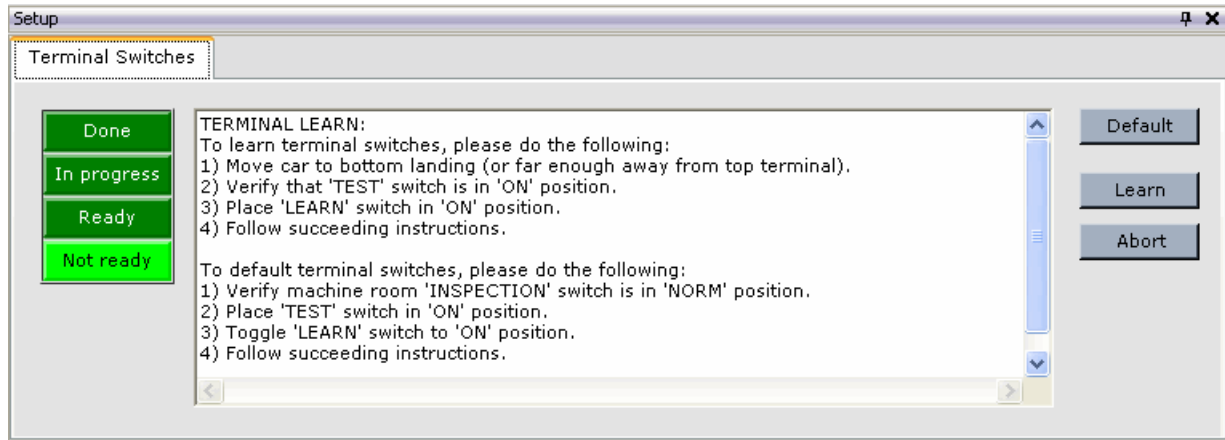
- **Inventory checksum fault indicator:** Indicates that the previously learned value of the inventory checksum does not match the value currently being reported by the safety processors. The inventory learn procedure must be performed before the car can run.
- **Inventory comparison fault indicator:** The Safety boards attached to the iBox do not match the safety board inventory in the safety system. The inventory learn procedure must be performed before the car can run.
- **Set button:** This function is primarily for factory use or for use as instructed by MCE.

Learn These controls are used to perform the safety inventory learn operation. The indicators on the left show the status of the learn operation and the text window provides information and instructions.

- **Learn button:** Learning the inventory causes the safety processors to take an inventory of the boards attached below the ICE-SAF board. When performing the inventory learn procedure, the car must be placed on Inspection mode. Follow the instructions in the display window. When the indicators show Ready, click the Learn button.
- **Erase button:** Causes the values currently stored in the Safety EEPROMS to be erased. This should be used as a last resort when troubleshooting inventory faults. Afterwards, the safety inventory, limit switches and safety configuration must be relearned.

Setup - Terminal Switches Tab

Used to perform the Terminal Learn procedure. [Please refer to “Learning Normal & Emergency Terminal Limit Switches” on page 4-9.](#)



- Learn operation indicators: Show progress through the various phases of the Terminal Learn operation.
- Message window: Provides feedback and instructions as required during the Learn operation.
- Learn button: Starts the Learn operation.
- Abort button: Aborts the Learn operation.
- Default button: Sets the switch Learned Values to values that allow the car to run without activating limit switch faults as long as the car remains in Test operation. The car is not allowed to run on passenger operation until real switch data is learned

Controller - Safety Tests

The Safety Tests pane provides highly automated control over final system testing performed before the car is turned over to normal operation.

Test Configuration

Test Name: Car / Counterweight Safety Test

Speed: ft/min Select

System status

Inspection Test Fault bypass

Runtime Status

Position	0.000	ft
Position indicator	60	
Speed	0.365	ft/min
Speed reference	500.000	ft/min
Maximum speed	0.451	ft/min

Fault Bypass Status

<input checked="" type="radio"/> Safety COS	<input checked="" type="radio"/> UNT1 Level 1	<input checked="" type="radio"/> DNT1 Level 1	<input checked="" type="radio"/> UNT1 Level 2	<input checked="" type="radio"/> DNT1 Level 2	
<input checked="" type="radio"/> Safety LOS	<input checked="" type="radio"/> UNT2 Level 1	<input checked="" type="radio"/> DNT2 Level 1	<input checked="" type="radio"/> UNT2 Level 2	<input checked="" type="radio"/> DNT2 Level 2	<input checked="" type="radio"/> UETS Level 2
<input checked="" type="radio"/> Safety IOS	<input checked="" type="radio"/> UNT3 Level 1	<input checked="" type="radio"/> DNT3 Level 1	<input checked="" type="radio"/> UNT3 Level 2	<input checked="" type="radio"/> DNT3 Level 2	<input checked="" type="radio"/> DETS Level 2
<input checked="" type="radio"/> Drive IOS	<input checked="" type="radio"/> UNT4 Level 1	<input checked="" type="radio"/> DNT4 Level 1	<input checked="" type="radio"/> UNT4 Level 2	<input checked="" type="radio"/> DNT4 Level 2	<input checked="" type="radio"/> Direction limit
<input checked="" type="radio"/> Speed Threshold	<input checked="" type="radio"/> UNT5 Level 1	<input checked="" type="radio"/> DNT5 Level 1	<input checked="" type="radio"/> UNT5 Level 2	<input checked="" type="radio"/> DNT5 Level 2	<input checked="" type="radio"/> Tach failure

Test

SAFETY SYSTEM TESTS - GENERAL INSTRUCTIONS
 READ THIS PAGE BEFORE BEGINNING ANY TESTS
 To perform a test-
 1. Determine the car speed for the test

Arm Test Abort

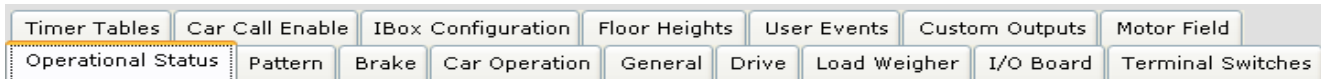
Please refer to “Safety Tests” on page 4-43 for details about running tests from this screen.

Controller - Layouts

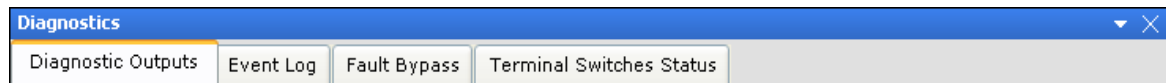
With iView, you can move and size tabs to suit the task to be performed. When you find a particularly arrangement to be useful, you can save it as a custom layout (View > Layouts > Save as). You can then display that layout at any time by selecting your custom layout from the View > Layouts > Custom menu.

Some useful layouts have been pre-programmed and are supplied with iView. They include:

- **Configuration:** This layout displays all of the configuration tabs for easy selection.



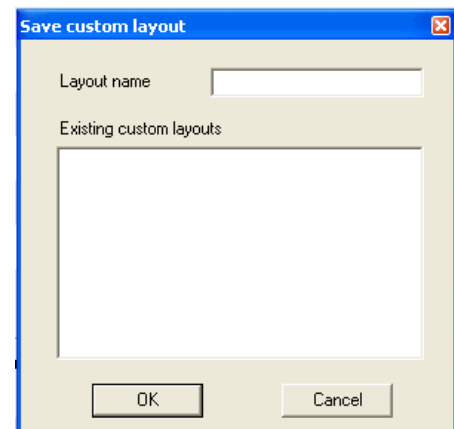
- **Diagnostics:** Displays all of the diagnostic tabs for easy selection.



- **Default:** Displays the default (initial connection) layout.


- **Brake:** Used to perform the brake calibration procedure. Displays the Brake setup and configuration tabs plus the hoistway pane.
- **Drive:** Used to perform the drive offsets calibration. Displays the Five setup and configuration tabs plus the Hoistway pane.
- **Floor Heights:** Used to perform the hoistway (floor heights) learn operation. Displays the Floor Heights setup and configuration tabs plus the Hoistway pane.
- **Load Weigher:** Used to perform the Load Weigher learn procedure. Displays the Load Weigher setup and configuration tabs plus the Hoistway pane.
- **Motor Field:** Used to perform the Motor Field Calibration procedure. Displays the Motor Field setup and configuration tabs plus the Hoistway pane.
- **Terminal Switches:** Used to perform the Terminal learn procedure. Displays the Terminal Switches setup, configuration and diagnostics tabs plus the Hoistway pane.

- **Custom:** Used to select a custom layout to be displayed. This is the listing of custom layouts created using View > Layouts > Save as.
- **Save As:** Used to create and save a custom layout.
 - Enter the name for the custom layout.
 - Click OK.



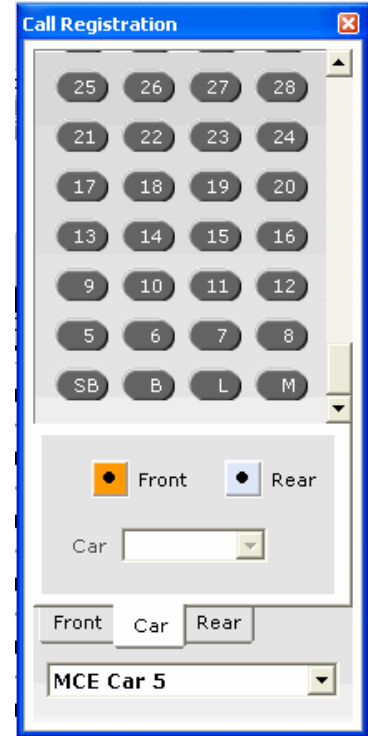
Call Registration

The Call Registration panel is available while working on any screen in iView.

- Call Registration : Opens the dialog used to register car calls.

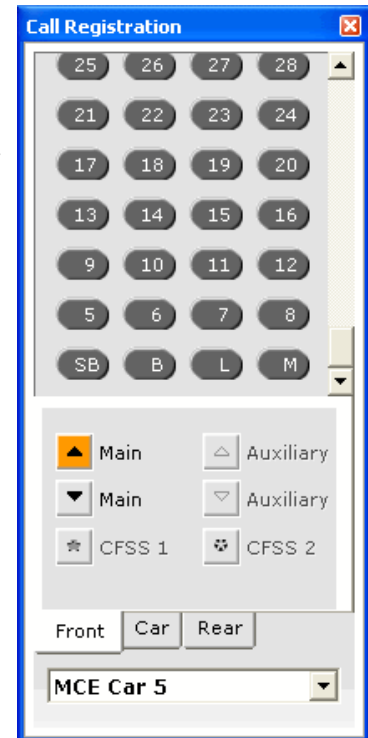
To register car calls:

1. Click the *Car* tab.
2. Select a car from the *Car* drop-down list (if available).
3. Click *Front* or *Rear*.
4. Click a *floor* button.
5. To close the dialog, click the “X” in the upper right corner.



To register hall calls:

1. Click the *Front* or *Rear* tab (or *Hall* tab if the car has only front doors).
2. Click the *Up Main*, *Down Main*, *Up Auxiliary*, *Down Auxiliary*, *CFSS1* or *CFSS2* call button.
3. Click the desired *floor* button(s).
4. To close the dialog, click the “X” in the upper right corner.



Controller - Firmware Update

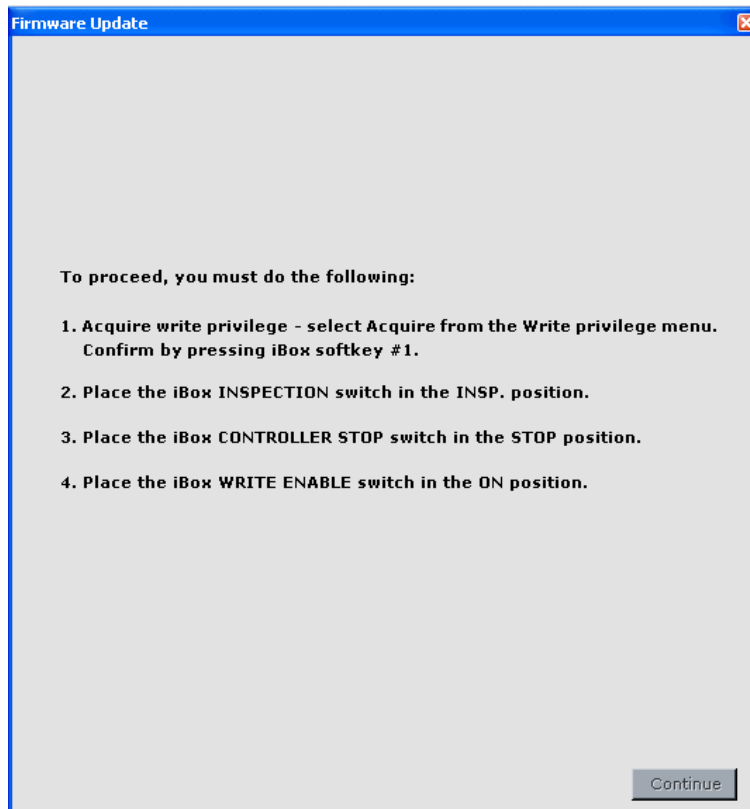
Warning! Do not attempt this procedure without first contacting MCE Technical Support. Failure to do so can result in catastrophic failure of the iBox.

Firmware Update allows you to install updated iControl operating software. It is likely that two firmware program files will be updated. They are:

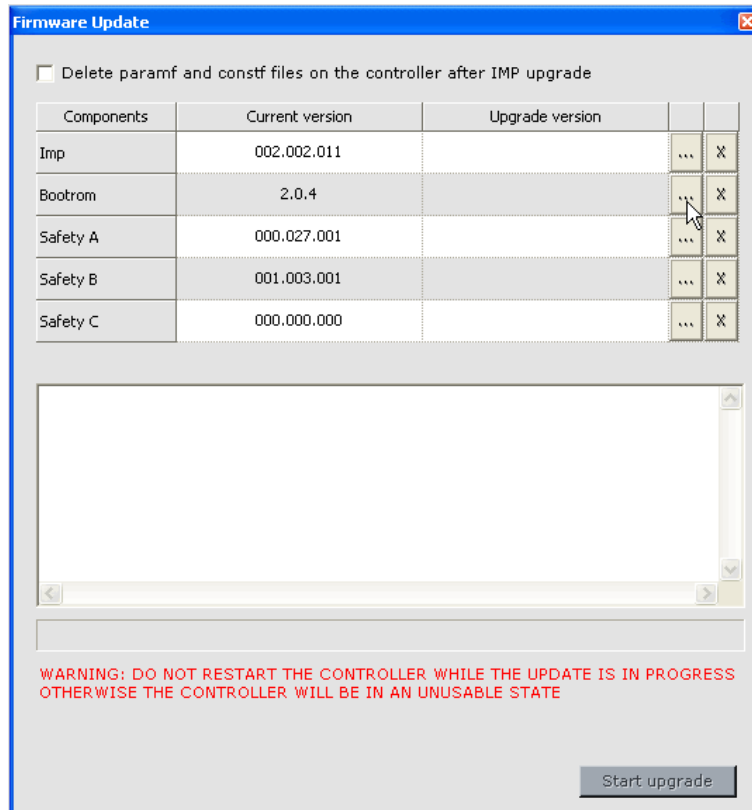
- Bootrom.mce, the iControl boot up program.
- vxworks.mce, the iControl IMP computer program.

To update iControl firmware:

1. Copy the new **Bootrom.mce** (Bootrom folder) and **vxworks.mce** (IMP folder) files to the desktop of the computer being used to perform the firmware update.
2. Use iView to connect to the iBox on which the firmware is being updated.
3. If you want to save the configuration settings for later re-loading, select **Save** from the File > Configuration File menu. In the *Save Configuration File* dialog, type a name in the **File name:** box and click **Save**. Please refer to “Saving Parameters to a Configuration File” on page 8-20.
4. Select **Firmware Update** from the *File* menu.
5. Click **Yes** in the dialog “This action will automatically deactivate all screens. Proceed?”



6. Follow instructions 1 through 4 in the Firmware Update dialog and then click **Continue**. The Firmware Update dialog will change to:



7. Update the Bootrom first. Double click the (...) in the *Bootrom* row.
8. Use the *Open* dialog to navigate to the computer's Desktop and double click the **Bootrom.mce** file. The bootrom file will load and the version will be indicated in the *Upgrade version* column.
9. Click **Start upgrade**. The upgrade progress will be indicated in the text window. When the upgrade is completed you will be instructed to close iView and press the iBox **Computer Reset** button.



Note

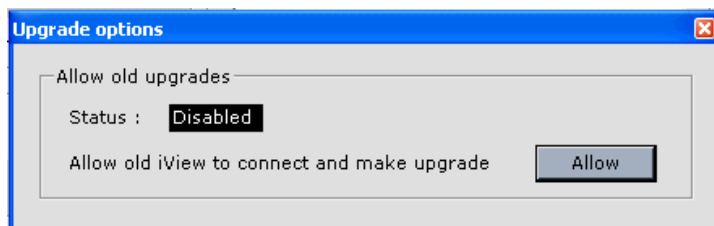
Note: If an *FrmFtp Login* dialog appears asking for a User and Password, click **OK**. The user name and password are not used for this operation at this time.

10. Use iView to connect to the iBox when it finishes the re-boot.
11. Repeat steps 4, 5 and 6.
12. Click the check box to **Delete the paramf and constf files on the controller after IMP upgrade**
13. Double click the (...) in the *Imp* row.

14. Use the *Open* dialog to navigate to the computer's Desktop and double click the **vxworks.mce** file. The IMP application file will load and the version will be indicated in the *Upgrade version* column.
15. Click **Start upgrade**. The upgrade progress will be indicated in the text window. When the upgrade is completed you will be instructed to close iView and press the iBox **Computer Reset** button.
16. Use iView to connect to the iBox when it finishes the re-boot.
17. Select **About iView** from the Help menu and verify the version numbers for the IMP Application and IMP Bootrom.
18. If you want to restore the original parameter settings which were saved in step #3, first acquire write privilege and then select **Load** from the File > Configuration file menu. [Please refer to "Loading Parameters from a Configuration File" on page 8-22.](#)
19. Select and Open or double click the desired file from the *Open Configuration File* dialog.
20. Select **All screens** or the **Selected screens** for which you wish to restore the original parameter settings, and click **OK**.

Upgrade Options

When upgrading firmware from a pre-December 2005 release to a later release, in the event that the Upgrade Wizard fails to properly load the parameters file, iView may not be able to connect to the upgraded controller. The Upgrade Options Dialog (File > Upgrade Options) can be used to enable iView to connect to the controller or iCue and complete the upgrade.





Quick Topics

- About this Section
- Selecting System View
- System Windows and Tabs
- System Configuration tab
- Emergency Power
- Legacy Group Interface
- Security
- System I/O
- Timer Tables
- User Events
- Remote Outputs
- Event Log
- System Hoistway
- System Performance
- Layouts



iView - System View



About this Section

This section contains detailed information about:

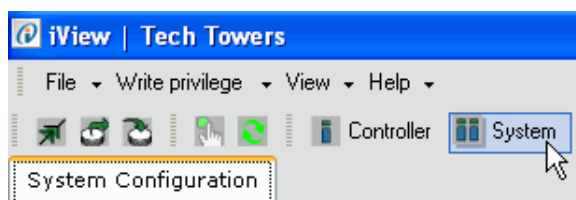
- [Selecting System View](#):
- [System View Windows and tabs](#): A complete list of System view windows and tabs, and information about the parameters on each.

Selecting System View

iView is used to view and adjust the Controller and System parameters. iView is divided into two main sections:

- Controller View - used to view and adjust the controller parameters, e.g., Brake, Drive, Pattern, Car Operation, etc. When iView first connects to an iController, the Controller view is displayed. [Please refer to “Selecting Controller View” on page 9-1.](#)
- System View - used to view and adjust the System parameters, e.g., Dispatching, Parking, Emergency Power, Security, etc. When iView is connected to a central dispatcher (iCentral), the Controller and System buttons are missing and System view is always displayed.

To select System view, click the System view button at the top of the iView screen.



System View Windows and Tabs

System View displays parameters, controls and diagnostics pertaining to system functions, e.g., hall calls, dispatching, parking, security, emergency power, etc. The parameters displayed in System view vary depending the type of controller and how it is configured (simplex, local, swing, local / dispatcher or central dispatcher). Please refer to “An Overview of System Options” on page 10-4. Table 10.1 lists the locations where the System parameters and settings are explained. If you are viewing this as a PDF file, click the page number link to jump to the description of the parameters on that tab.

Table 10.1 System View Windows and Tabs

Windows	Tabs	See
Configuration Tabs	System Configuration	page 10-6
	Emergency Power	page 10-33
	Legacy Group Interface	page 10-36
	Security	page 10-38
	System I/O	page 10-51
	Timer Tables	page 10-62
	User Events	page 10-65
	Remote Outputs	page 10-66
Diagnostic Tabs	Event Log	page 10-68
Hoistway		page 10-70
System Performance		page 10-74
Layouts	Configuration	page 10-75
	Diagnostics	
	Default	
	Custom	

Button Bar

Table 9.2 lists the locations where the functions of the buttons are explained.

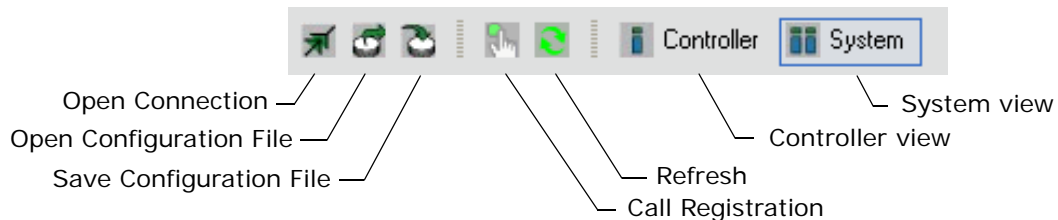
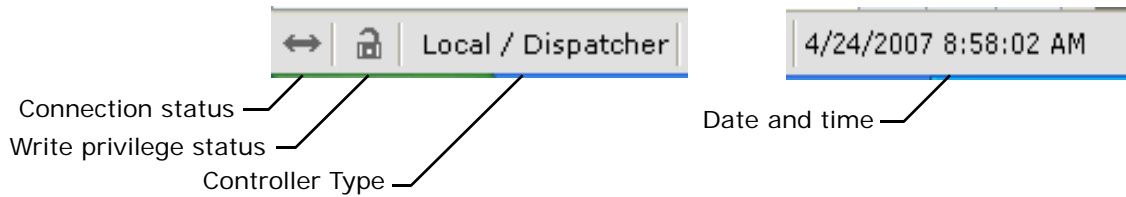


Table 10.2 Buttons and Dialogs

Buttons / Dialogs	Description	See
Open Connection	Displays the Open dialog	page 8-11
Open Configuration File	Displays the Open Configuration File dialog	page 8-22
Save Configuration File	Displays the Save Configuration File dialog	page 8-20
Call Registration	Place car calls and hall calls	page 10-73
Refresh	Refreshes the parameters being displayed	
Firmware Update	Update the iBox imbedded firmware	page 9-155
Controller	Causes the Controller view to be displayed	page 9-1
System	Causes the System view to be displayed	page 10-1

iView Status Bar

The status bar at the bottom of the iView screen provides the following information:



Connection Status Connected arrows, shown above, indicate that iView is communicating with the controller. Broken arrows indicate that the connection has been broken.

Write Privilege Status An unlocked lock, shown above, indicates that this connection does not have write privilege. A locked lock indicates that write privilege has been granted.

Controller Type Indicates the type of controller to which iView is connected. For a description of each type see [“An Overview of System Options” on page 10-4](#) The controller types include:

- Simplex - a single car that is not part of a group.
- Local - a car that is part of a group.
- Local (Swing) - a local car that can swing away (detach from the group).
- Swing - a local car that is currently detached from the group and is acting like a simplex.
- Local (Alternate Dispatcher) - a local car that can assume dispatching responsibilities.
- Local / Dispatcher - a local car that is also currently the dispatcher. iCue dispatching software is running on the local car’s iBox.
- iCentral - a central dispatcher with iCue dispatching software running on a dedicated PC or embedded microcontroller.

An Overview of System Options

Depending on user needs, the iControl System can be configured in a number of ways. System functions can be performed by a central dispatcher (iCentral). In addition, each iController can perform certain system functions depending on its configuration (Simplex, Local, Swing or Local / Dispatcher).

The following are brief descriptions of the various ways in which iControl can be configured. Please refer to [“iControl System Options” on page 10-5](#) for additional information.

Simplex An elevator operating alone, not connected to a group, is called a Simplex. The parameters which control the Hall Call Eligibility, Parking, Parking Eligibility, etc. are programmed on the car controller’s System View tabs. Simplex operation is enabled via the *Simplex car* parameter on the Controller > Configuration > General > General tab (see [“Configuration - General” on page 9-95](#)).

Local MCE uses the term Local to refer to an individual car that is part of a group of elevators. Dispatching and parking functions for a Local are performed by either a Local / Dispatcher or a Central Dispatcher. The only System parameter used by a Local car is the Car label on the System Configuration > Building tab.

Swing - Local (Swing) *Local (Swing)* is displayed on the iView status bar when a Local car has been configured so that it can, on command, operate independent of the group using an auxiliary hall call riser. *Swing* is displayed when the car is actually on swing operation. The parameters which control the Hall Call Eligibility, Parking, Parking Eligibility and (if applicable) CFSS and Security while the car is on Swing operation, are programmed on the Swing car’s System View tabs and stored on the Swing car controller. Automatic Swing operation, is enabled via the Automatic Swing Operation *Enable* parameter on the Controller > Configuration > Passenger tab (see [“Car Operation - Passenger Tab” on page 9-37](#)). Swing operation can also be initiated using the Swing Operation Switch input which can be programmed using the Controller > Configuration > I/O Boards tab (see [“Configuration - I/O Boards” on page 9-100](#)).

Local / Dispatcher - Local (Alternate Dispatcher) Beginning with the December 2006 Release, in addition to performing car control functions, iControllers can assume full dispatching responsibilities for a group of elevators. *Local / Dispatcher* is displayed on the status bar of a Local car that is performing the dispatching functions. One or more Local cars can be designated as an *Alternate Dispatcher*, meaning that they can act as a backup for a central dispatcher or as one of several potential dispatchers for a group that has no central dispatcher. The Alternate Dispatcher controls on the System Configuration > Building tab are used to designate the cars and preference order for selecting the Local / Dispatcher (see [“Building” on page 10-7](#)). The Dispatching, Hall Call Eligibility, Parking, etc. parameters are programmed on the System tabs of the car that is currently the Local / Dispatcher. These settings are automatically copied to all cars designated as Alternate Dispatcher.

iCentral A central dispatcher (iCentral) can be used to perform the dispatching functions for a group of iControllers. The iCue dispatching software runs on a dedicated PC or embedded microcontroller. This solution is used for the most demanding iControl systems. When iView connects to a central dispatcher, *iCentral* is displayed on the status bar and iView displays only the System view windows and tabs. The Dispatching, Hall Call Eligibility, Parking, etc. parameters are programmed on the central dispatcher’s System tabs and are automatically copied to all cars designated as Alternate Dispatcher.

Figure 10.1 iControl System Options

iCentral
iBox computer

<p>iCentral iCue PC</p> <p>Performs dispatching and group management functions for an elevator group</p> <p>Connect to iCue PC using a unique iView connection.</p> <p><u>System parameters used</u> Note: These parameters are passed to any cars designated as Alternate Dispatcher.</p> <p><u>Dispatching</u> Building configuration Hall call eligibility Parking Parking eligibility Mode of Operation CFSS Split Bank</p> <p><u>Group Management</u> Emergency Power Security System I/O Timer Tables User Inputs User Outputs</p> <p>System Performance System Event Log</p> <p>Legacy Group Interface Cross cancellation Cross registration</p>	<p><u>Simplex</u> (Not part of a group) The following system parameters are set and stored on the Simplex car controller:</p> <p><u>System parameters used</u> Building Configuration Hall call eligibility, Parking eligibility Parking configurations CFSS</p> <p>Emergency Power Security System I/O</p>	<p><u>Local</u> (Part of a group) Dispatching functions are performed by an iCentral or a Local/Dispatcher.</p> <p>Dispatching parameters on this car are not used.</p> <p><u>System parameters used</u> Building configuration (car labels)</p>	<p><u>Swing</u> (Local car, sometimes acts as a simplex) When not on Swing operation, dispatching is performed by the an iCentral or a Local / Dispatcher using the parameters set on the iCentral or Local / Dispatcher.</p> <p>When the car is on Swing operation the following parameters set and stored on the Swing car are used:</p> <p><u>System parameters used</u> Building configuration Hall call eligibility Parking Parking eligibility Mode of Operation CFSS</p> <p>Emergency Power Security System I/O</p>	<p><u>Local / Dispatcher</u> Performs the dispatching and group management functions for a group of elevators. Can be a backup for an iCentral (full dispatching capabilities).</p> <p>All system parameters are set on the current Local / Dispatcher and passed to designated Alternate Dispatchers.</p> <p><u>System parameters used</u> Building configuration Hall call eligibility Parking Parking eligibility Mode of Operation CFSS</p> <p>Emergency Power Security System I/O Timer Tables User Inputs User Outputs</p> <p>System Performance Event Log</p>	<p><u>Controller parameters</u></p> <p><u>Configuration</u> Brake Car Call Enable Car Operation Drive Floor Heights General I/O Boards iBox configuration Load Weigher Motor Field Pattern Terminal Switches Timer Tables Custom Outputs User Inputs</p> <p><u>Diagnostics</u> Diagnostic Outputs Event Log Fault Bypass Terminal Switches</p> <p><u>Setups</u> Data Trap Hoistway Outputs Safety Tests Virtual Oscilloscope Layouts</p>
--	---	--	--	--	--

Car Control: Manages the operation (car calls, door operation, movement, etc.) of an elevator using the Controller parameters.
System Control: Can be configured as a Simplex, Local, Swing, or Local/Dispatcher.

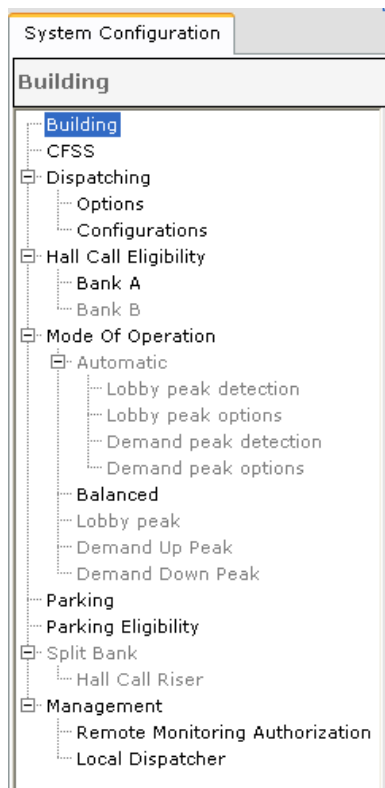
Connect to iCentral using a unique iView connection.

System parameters

An iCentral can be configured as one of the following

System Configuration tab

The System Configuration tab is used to program the dispatching parameters for a Simplex car, Swing car, or AGC (Local Dispatcher). This tab provides access to controls affecting dispatching, parking, operational modes, etc.



Through the tree on the left side of this tab, you can access:

- **Building:** Set the highest floor served, number of cars, floor and car labels, etc. (see page 10-7).
- **CFSS:** Set recall-to-floor eligibility when operating in a Commander for Special Service mode (see page 10-9).
- **Dispatching:** General dispatching controls (see page 10-11).
- **Hall Call Eligibility:** On a per-floor, per-configuration basis (1 – 8), select the hall calls to which the car(s) may respond (see page 10-13).
- **Mode of Operation:** Setup the dispatching mode of operation parameters and configurations (see page 10-14).
- **Parking:** Set parking options and floors for Parking configurations (see page 10-20).
- **Parking Eligibility:** On per-configuration basis (1 – 8), set the parking eligibility parameters for the car (see page 10-27).
- **Split Bank:** Split Bank operation is available only on the Central Dispatcher (see page 10-29).
- **Management:** Provides access to the following:
 - **Remote Monitoring Authorization:** Use to authorize a third party remote monitoring tool to connect to iControl (see page 10-31).
 - **Local Dispatcher:** Use to force the system to resend the system parameters to all connected cars (see page 10-32).

Building

The Building page is used to set the highest floor served, number of cars, floor and car labels, job name and number, and to program Local / Dispatcher selection parameters.

The screenshot shows the 'Building' configuration page. On the left is a tree view with categories like 'Dispatching', 'Hall Call Eligibility', 'Mode Of Operation', 'Parking', 'Split Bank', and 'Management'. The main area contains:

- Floors:** A dropdown set to 60 and a table with columns 'Floor' and 'Floor label'. The table lists floors 1 through 12 with labels: 12 (12), 11 (11), 10 (10), 9 (9), 8 (8), 7 (7), 6 (6), 5 (5), 4 (M), 3 (L), 2 (B), 1 (SB).
- Cars:** A dropdown set to 3 and a table with columns 'Car' and 'Car label'. The table lists cars 1 through 3 with labels: 3 (3), 2 (2), 1 (1).
- Dispatcher:** A section for 'Car 1' with an 'Alternate Dispatcher' sub-section. It includes a 'Selection' area with a dropdown set to 1 and 'Manual Select' and 'Auto Select' buttons. Below is an 'Auto-select Preference Order' section with two columns: 'Local Cars' (containing 3) and 'Alternate Dispatcher' (containing 1 and 2). Arrows and 'Up'/'Down' buttons are used to move items between these columns.
- Job Information:** Fields for 'Job name' (Job Name) and 'Mce job number' (0).

Floors

- **Floors:** Indicates the highest floor served by this car.
- **Floor label:** If desired, provide a label, up to three characters, for any or all floors. Highlight the default floor label (number) and type a new label. Click Send when you have finished setting parameters on this page.

Cars

- **Cars:** Indicates the number of cars in the group. If this is a Simplex the default is 1 and the parameter is read only.
- **Car label:** If desired provide a label for the car(s), up to three characters.

Job Information

- **Job name:** Indicates the name of the job.
- **MCE job number:** Indicates the job number assigned by MCE.

Dispatcher Displays a car identifier of the car that is currently the Local/Dispatcher or iCentral to indicate that the central dispatcher is doing the dispatching.

Alternate Dispatcher Use these controls to designate which car(s) can be the Local/Dispatcher and to manually select or auto-select a different car to be the Local/Dispatcher.

- **Manual Select button:** When iView is connected to the Local/Dispatcher, this button can be used to manually select any car on the Alternate Dispatcher list to be the Local/Dispatcher. Choose the desired car from the Cars drop down list. When iView is connected to any other car in the Alternate Dispatcher list (not the Local/Dispatcher), only the car to which iView is connected can be manually selected to be the Local/Dispatcher.
- **Auto Select button:** When iView is connected to the Local/Dispatcher, this button can be used to request that another car on the Alternate Dispatcher list be auto-selected to be the Local/Dispatcher.
- **Auto-select Preference Order:** This control is used to designate which cars can become the Local/Dispatcher and the order in which they are to be selected. Initially all cars are shown in the Local Cars list.
 1. Click to select cars in the Local Cars list and use the right arrow to move them into the Alternate Dispatcher list.
 2. Click to select cars in the Alternate Dispatcher list and use the Up and Down buttons to place them in the desired order. The highest on the list is selected first. If the first on the list is not available, the next on the list is selected, and so fourth. Once a car has assumed the Local Dispatcher roll it continues in that roll even if a car that is higher on the list becomes available.
 3. To remove a car from the Alternate Dispatcher list, click to select the car and use the left arrow to move it to the Local Cars list.



Caution

The “Auto-select Preference Order” settings must be identical for every car within a group of elevators. [Please refer to “Before connecting the “System” ethernet cable to the iBox:” on page 2-31.](#)

CFSS (Commandeer for Special Services)

This tab allows you to set car recall floor eligibility for Commandeer For Special Service operation. Car behavior during CFSS recall and operation is determined on the Controller > Configuration - Car operation > CFSS tab. Please refer to “Car Operation - CFSS Tab” on page 9-73.

System Configuration

CFSS

- Building
 - CFSS
- Dispatching
 - Options
 - Configurations
- Hall Call Eligibility
 - Bank A
 - Bank B
- Mode Of Operation
 - Automatic
 - Lobby peak detection
 - Lobby peak options
 - Demand peak detection
 - Demand peak options
 - Balanced
 - Lobby peak
 - Demand Up Peak
 - Demand Down Peak
 - Parking
 - Parking Eligibility
- Split Bank
 - Hall Call Riser
- Management
 - Remote Monitoring Authorization
 - Local Dispatcher

Select a CFSS configuration (1 thru 2) 1

Maximum number of cars to operate on CFSS mode 1 at the same time 1

Allow multiple CFSS mode 1 hall calls per car

Per car settings

Select a car to configure 1

Floor label	Front	Rear
11		
10		
9		
8		
7		
6		
5		
M	✓	
L	✓	
S	✓	
SB	✓	

Select

Deselect

Send

To program a CFSS Configuration

- Select a CFSS configuration (1 through 2): Select the CFSS configuration you wish to edit.
- Maximum number of cars to operate on CFSS Mode “n” at the same time: Set the number of cars allowed to be in CFSS mode “n” at the same time. (Not pertinent to Simplex operation.)
- Allow multiple CFSS Mode “n” hall calls per car: If multiple CFSS recall hall switches are simultaneously latched for this mode, they will be serviced (recall/CFSS in-car/release) in the sequence in which they were registered.

Making Settings Per-Car Verify the “Select a car to configure (1) drop-down box. (There must also be a CFSS recall switch physically at the eligible Front or Rear door locations on a floor selected to be eligible to initiate CFSS recall.)

Enable individual floor/recall location eligibility. You can make a selection in a few different ways:

- Click in the door/hall call column in the desired floor row to enable or disable.
- Click and drag in a column to select multiple floors, then click the Select control to allow calls or the Deselect control to restrict calls.
- Click in the column head (i.e., Front) to highlight the entire column (all floors), then use the system-wide Select calls or Deselect calls controls.

Dispatching - Options

Dispatching options allow you to set up conditions that favor the assignment of one car or another.

System Configuration

Options

- Building
 - CFSS
 - Dispatching
 - Options**
 - Configurations
 - Hall Call Eligibility
 - Bank A
 - Bank B
 - Mode Of Operation
 - Automatic
 - Lobby peak detection
 - Lobby peak options
 - Demand peak detection
 - Demand peak options
 - Balanced
 - Lobby peak
 - Demand Up Peak
 - Demand Down Peak
 - Parking

Dispatching bonus

Car at the same floor	1	sec
Coincidence call	3	sec

Dispatching penalty

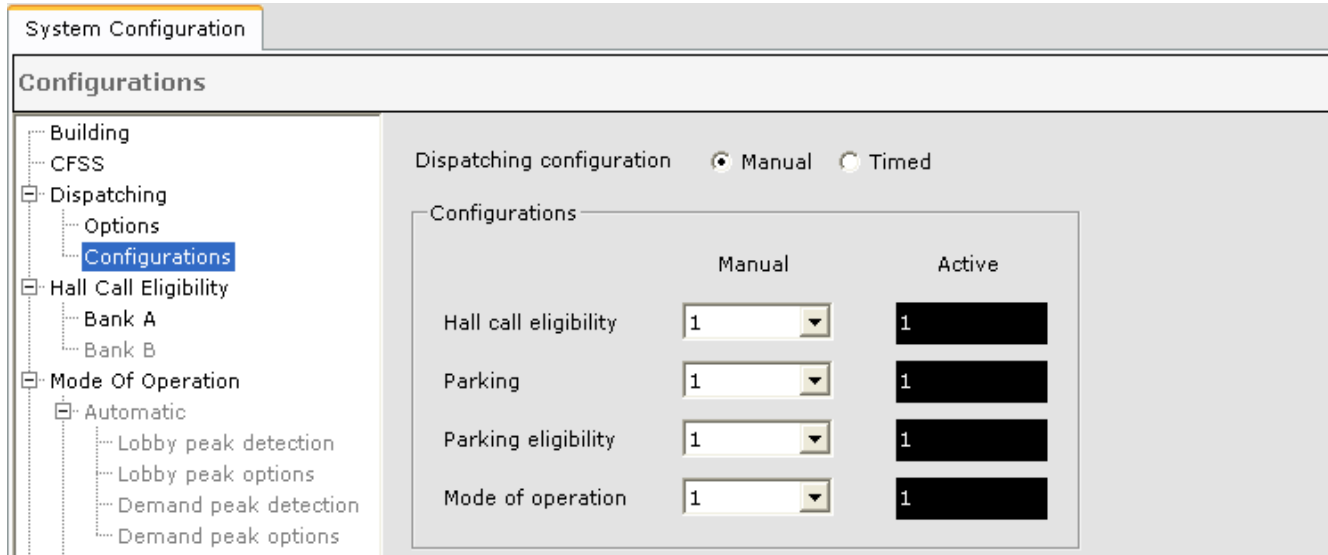
Retask	5	sec
Move lobby parked car	10	sec
Move non-lobby parked car	5	sec
Move idle car	2	sec

Allow same floor hall calls to reverse doors on a departing car

When assigning hall calls to cars, iControl determines which car can respond in the least time considering where each car is, its direction of travel, parking assignment and status (moving or idle). By adding bonus or penalty seconds to the response time under certain conditions, you can influence dispatching assignments.

- **Car at same floor bonus:** If a car is at the same floor as a newly-registered hall call, credit its response time (favor its assignment) by the set number of seconds.
- **Coincidence call bonus:** If a car is on its way to a floor when a hall call is registered from that same floor, credit its response time (favor its assignment) by the set time in seconds.
- **Retask penalty:** When considering reassigning a call from one car to another to improve response time, debit the response time of all cars except the one to which the call is currently assigned (penalize reassignment) by the set number of seconds.
- **Move lobby parked car penalty:** When making a hall call assignment or reassignment, debit the response time of any car parked at a lobby (penalize its assignment) by the set number of seconds. (This allows you to skew the decision in favor of keeping the lobby parked cars available at the lobby.)
- **Move non-lobby parked car penalty:** When making a hall call assignment or reassignment, debit the response time of any car parked at non-lobby floors (penalize its assignment) by the set number of seconds. (This allows you to skew the decision in favor of keeping parked cars available at their parking floor.)
- **Move idle car penalty:** When making a hall call assignment or reassignment, debit the response time of any idle car (penalize its assignment) by the set number of seconds.
- **Allow same floor hall calls to reverse doors on a departing car:** If enabled, a hall call placed at the floor/riser where a car is preparing to depart (closing its doors) will cause the doors to reopen.

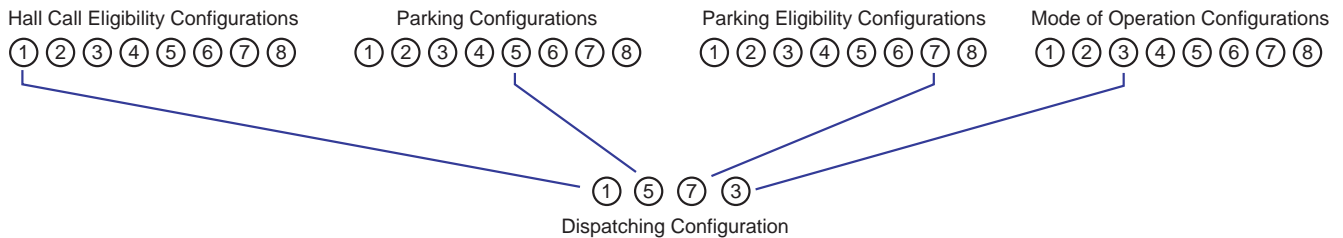
Dispatching - Configurations



These controls determine how four types of pre-programmed dispatching configurations are selected to be the active configuration. Up to eight configurations of each type can be programmed.

- **Dispatching configuration:** The currently active configuration can be selected manually (Manual) or by a timer schedule (Timed).
- **Configurations:**
 - **Manual:** When Dispatching configuration is set to manual, you can select which configuration is active in the Manual column. When a setting is changed, it becomes active after you Send it to the controller.
 - **Timed:** Select Timed to have the currently active configurations determined via timer table. [Please refer to “Configuration Tabs - Timer Tables \(System\)” on page 10-62.](#)
 - **Active:** The dispatching configurations that are currently active are shown in the “Active” column. The four types of dispatching configurations are:
 - Hall Call Eligibility Parking
 - Parking Eligibility Mode of Operation

The configurations you are selecting here are configured on the screen tabs of the same name.



Hall Call Eligibility

Use these controls to create up to eight different Hall Call Eligibility configurations. Each configuration includes eligibility permissions/restrictions for the car. The active configuration can be selected and run manually or by timer table.

System Configuration

Bank A

Select a hall call configuration (1 thru 8) 1

Convert front auxiliary hall call riser to front main hall call riser

Convert rear auxiliary hall call riser to rear main hall call riser

Per car settings

Select car to configure 1

Floor label	Front Main Up	Front Main Down	Rear Main Up	Rear Main Down	Front Aux Up	Front Aux Down	Rear Aux Up	Rear Aux Down
11	✓	✓						
10	✓	✓						
9	✓	✓						
8	✓	✓						
7	✓	✓						
6	✓	✓						
5	✓	✓						
M	✓	✓						
L	✓	✓						
S	✓	✓						
SB	✓							

Select

Deselect

The following controls are found on the Hall Call Eligibility tab.

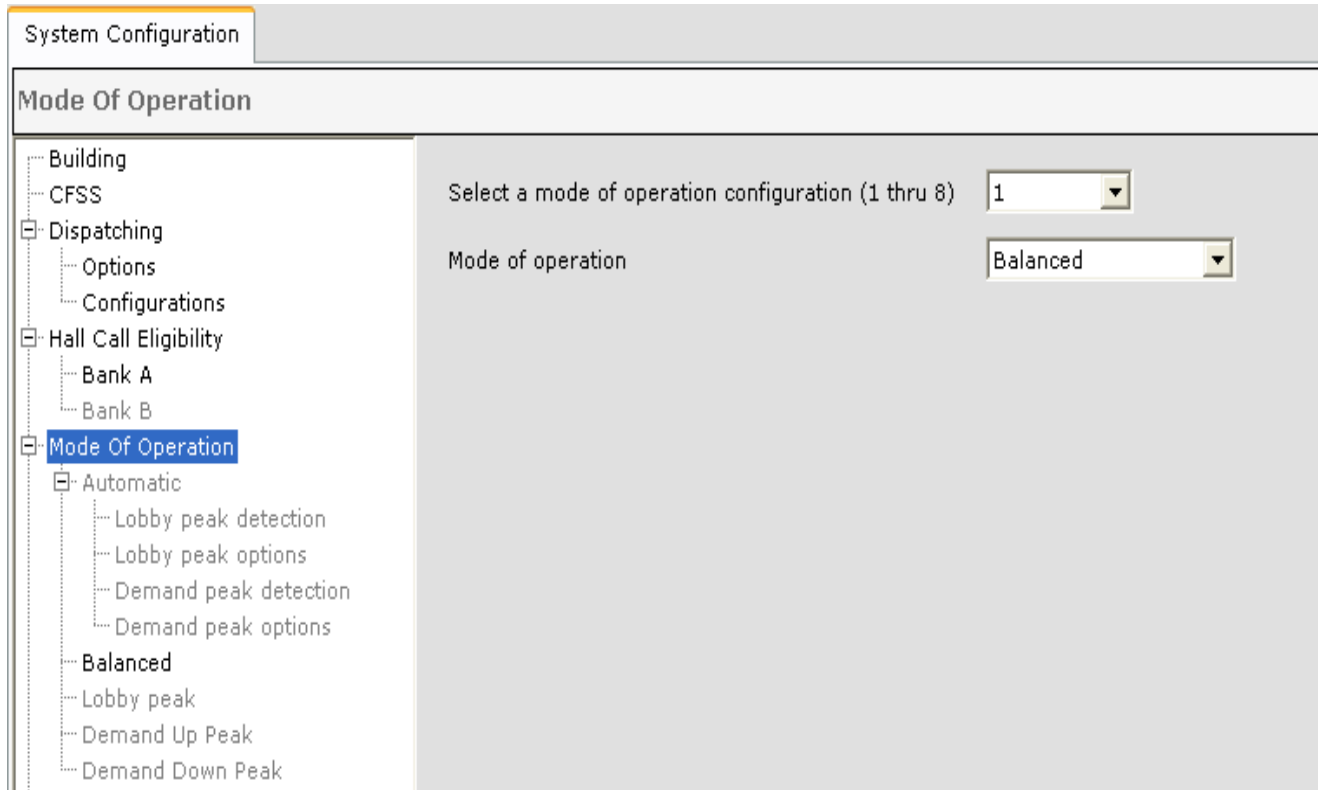
- Select the Hall Call Eligibility configuration (1 - 8) you want to create or edit.
- Convert Front (Rear) Auxiliary Hall Call Riser to Front (Rear) Main Hall Call Riser: If, when this configuration is active, you want one or both of the auxiliary hall risers to function as additional sets of main risers, enable the appropriate choice.
- Select car to configure: For a Simplex this will default to 1.

Eligibility Table For each floor (listed in the left-most column), a check mark in any of the remaining columns indicates that the associated hall call is eligible to be registered at that floor. You can make a selection in a few different ways:

1. Click in individual cells to enable or disable, or
2. Click and drag in a column to select multiple floors, then click to Select allow calls or Deselect to restrict calls, or
3. Click in the column head (i.e., Front Main Up) to highlight the entire column (all floors), then use the Select or Deselect buttons.
4. When you are satisfied with your settings, click Send to send the data to the iBox.
5. Continue to create configurations (up to eight) as needed.

Mode of Operation

Use these controls to create or edit up to eight Mode of operation configurations. Each configuration, when active, determines and defines the dispatching mode. The currently active configuration can be selected manually (Dispatching > Configuration tab) or by timer table.



The screenshot shows the 'System Configuration' window with the 'Mode Of Operation' section selected. On the left is a tree view with 'Mode Of Operation' highlighted. The main area contains two dropdown menus: 'Select a mode of operation configuration (1 thru 8)' set to '1' and 'Mode of operation' set to 'Balanced'.

Select a Configuration

- Select a mode of operation configuration to edit/create (1 – 8). Screen information will automatically update when a configuration is selected.

Mode of Operation

Specifies the dispatching mode to be used when the selected configuration is active. The options are:

- **Automatic:** The dispatching mode (Balanced, Demand Up Peak, or Demand down peak) is automatically selected depending on building demands.
- **Balanced:** Selects balanced dispatching, favoring neither up nor down traffic.
- **Lobby Peak:** Favors lobby traffic (not applicable to simplex operation).
- **Demand up peak:** Typically used during morning arrival when demand is predominantly in the up direction. The controller keeps track of bypassed call demands, which occur when the car becomes heavily loaded, and manages call assignments to ensure that no calls are ignored due to heavy loads.
- **Demand down peak:** Typically used during afternoon departure when demand is predominantly in the down direction. The controller keeps track of bypassed call demands, which occur when the car becomes heavily loaded, and manages call assignments to ensure that no calls are ignored due to heavy loads.

To edit or change the mode currently assigned to the selected configuration:

1. Select the mode of operation configuration number.
2. Select the mode of operation you want enabled when the configuration is active:
 - Automatic
 - Balanced
 - Lobby peak
 - Demand Up Peak
 - Demand Down Peak

Automatic

iControl will automatically determine which operating mode to use at any one time. The Automatic “sub controls” allow you to fine tune the selection criteria. The “hysteresis” timer set here affects every mode change made automatically for the selected configuration. The timer says that, “after changing modes, it cannot change again for X minutes.” This prevents rapid changes in traffic data from forcing operating modes to change constantly (which would disrupt service efficiency).

Mode hysteresis timer min

Lobby Peak Detection Criteria Lets you fine tune the criteria that will cause iControl to detect a need to select Lobby Peak operation.

Allow lobby peak detection

Number of loaded cars to initiate lobby peak

Lobby peak loaded car detection method

Number of car calls to consider car loaded

- **Allow lobby peak detection:** If you want iControl to detect the need to switch to lobby peak operation, enable this check box.
- **Lobby peak loaded car detection method:**
 - **Load weigher:** iControl will automatically engage Lobby Peak mode as determined by factoring the number of successive heavy load cars leaving the lobby with the interval between when a car leaves the lobby and when the next lobby hall call is registered. Uses the “Number of loaded cars to initiate lobby peak” setting.
 - **Car calls:** iControl will automatically engage Lobby Peak based on successive cars departing the lobby with a car call quantity equal to or greater than that set here. Uses the “Number of car calls to consider car loaded” setting.

Lobby Peak Options Allows you to fine tune system behavior when Lobby Peak is automatically selected by the group control.

Always keep at least Car(s) in balanced mode

Door dwell time sec

Use load weigher monitoring to cancel door dwell when car weight reaches "heavy load" weight

Use car call monitoring to cancel door dwell when or more car calls are registered

Use % of total "in use" cars for lobby peak service at this floor

Select cars eligible for lobby peak service and place them in order of preference

Cars in group		Lobby peak cars	
	Add	a	Up
	Remove	b	
		c	
		d	
		e	
		f	
		g	
		h	Down

- Always keep at least car(s) in balanced mode: If you want to hold one or more cars in balanced service mode (non lobby peak) when lobby peak is active, set that number of cars here.
 1. Set lobby door dwell time. (The time the doors stand open before attempting to close.)
 2. During busy conditions, you can choose to employ load weigher monitoring or car call monitoring to decrease door dwell time and prepare the car to leave the lobby:
 - Use load weigher monitoring...: If you want the load weigher used to determine when door dwell should be shortened. When the car weight reaches the "heavy load" setting (car controller Load Weigher screen setting), the doors will begin closing in preparation to leave the lobby.
 - Use car call monitoring...: If you want to monitor the number of calls placed in the car to determine when door dwell should be shortened. When the number of car calls placed reaches the quantity set here, the doors will begin closing in preparation to leave the lobby.
 3. If desired, you can set a (dynamic) percentage of the "in-use" cars to use for lobby peak service at this lobby floor. (For example, this is useful if the group is split between two lobbies and you want 50% of the available cars servicing one and 50% of the available cars servicing the other.)
 4. Choose to use only specific cars for lobby peak service and even set the priority in which you want them used. (Higher position in list = use first.)

Demand Peak Detection Criteria Sets the conditions under which iControl will automatically enable demand peak operation.

Allow demand up peak detection
 Allow demand down peak detection
 Peak direction hall call percentage volume
 Number of floors with peak direction hall calls

- **Allow demand up peak detection:** Enable to allow iControl to detect demand up peak conditions.
- **Allow demand down peak detection:** Enable to allow iControl to detect demand down peak conditions.
- **Peak detection hall call percentage volume:** When the percentage of hall calls in one direction (up or down), equals or exceeds this percentage of total hall calls, iControl will select demand peak operation in that direction. A typical setting is 75 to 80%.
- **Number of floors with peak direction hall calls:** When the number of floors with hall calls in one direction (up or down) exceeds this number, iControl will select demand peak operation in that direction.

Demand Peak Options Fine tunes system behavior when demand peak is active.

Non-peak hall call assignment penalty

- **Non-peak hall call assignment penalty:** When demand peak operation is active, hall calls in the non-peak direction (i.e., up calls during Demand Down operation), receive lower priority service. If both peak and non-peak direction hall calls are active, the dispatcher compares how long each has been registered when deciding which will be assigned the next available car. The time entered here is subtracted from the non-peak direction call registered time, causing the peak direction call to be favored.

Balanced

Balanced mode provides equal treatment for up and down calls, favoring neither up nor down traffic.

Lobby Peak

When active by manual or timer selection, operates group cars in Lobby Peak mode.

Always keep at least Car(s) in balanced mode

Lobby 1 | Lobby 2

Enable lobby peak for lobby 1

Lobby floor

Door dwell time sec

Use load weigher monitoring to cancel door dwell when car weight reaches "heavy load" weight

Use car call monitoring to cancel door dwell when or more car calls are registered

Use % of total "in use" cars for lobby peak service at this floor

Peak direction & call types Select cars eligible for lobby peak service and place them in order of preference

<input type="checkbox"/> Up <input type="checkbox"/> Down	<input type="checkbox"/> Main front <input type="checkbox"/> Main rear <input type="checkbox"/> AUX. front <input type="checkbox"/> AUX. rear	Cars in group <input type="text"/>	<input type="button" value="Add"/> <input type="button" value="Remove"/>	Lobby peak cars <input type="text" value="a"/> <input type="text" value="b"/> <input type="text" value="c"/> <input type="text" value="d"/> <input type="text" value="e"/> <input type="text" value="f"/> <input type="text" value="g"/> <input type="text" value="h"/>	<input type="button" value="Up"/> <input type="button" value="Down"/>
	<input type="checkbox"/> Main front <input type="checkbox"/> Main rear <input type="checkbox"/> AUX. front <input type="checkbox"/> AUX. rear				

To configure Lobby Peak:

- Select a lobby to configure.
- Settings Per Lobby:
 1. For the selected lobby (1 or 2), enable or disable Lobby peak mode operation.
 2. Set the lobby floor.
 3. Set lobby door dwell time. (The time the doors stand open before attempting to close.)
 4. During busy conditions, you can choose to employ load weigher monitoring or car call monitoring to decrease door dwell time and prepare the car to leave the lobby:
 - Use load weigher monitoring...: If you want the load weigher used to determine when door dwell should be shortened. When the car weight reaches the "heavy load" setting (car controller Load Weigher screen setting), the doors will begin closing in preparation to leave the lobby.
 - Use car call monitoring...: If you want to monitor the number of calls placed in the car to determine when door dwell should be shortened. When the number of car calls placed reaches the quantity set here, the doors will begin closing in preparation to leave the lobby.

5. If desired, you can set a (dynamic) percentage of the “in-use” cars to use for lobby peak service at this lobby floor. (For example, this is useful if the group is split between two lobbies and you want 50% of the available cars servicing one and 50% of the available cars servicing the other.)
6. Select the direction of peak traffic from this lobby (Up or Down).
7. Select the call types available in the lobby.
8. Finally, you can choose to use only specific cars for lobby peak service and even set the priority in which you want them used. (Higher position in list = use first.)

Demand Up Peak

Demand Up Peak is generally used during hours when traffic demand in the building is largely in the up direction.

Main exit floor	1
Non-peak hall call assignment penalty	0
Select peak hall call types	<input type="checkbox"/> Main front <input type="checkbox"/> Main rear <input type="checkbox"/> AUX. front <input type="checkbox"/> AUX. rear

- **Main exit floor:** If much of the traffic is exiting at a particular floor (i.e., the main employer in an office building), setting that floor number here will allow the system to assign calls so that floor receives the best possible service.
- **Non-peak hall call assignment penalty:** Favors demand up peak calls by adding the number of seconds entered here to their time of registration, making them appear to have been registered sooner and thus have more priority.
- **Peak hall call types:** If appropriate, allows you to select those risers on which up hall calls will be identified as demand up peak calls.

Demand Down Peak

Demand Down Peak is generally used during hours when traffic demand in the building is largely in the down direction.

Main exit floor	1
Non-peak hall call assignment penalty	0
Select peak hall call types	<input type="checkbox"/> Main front <input type="checkbox"/> Main rear <input type="checkbox"/> AUX. front <input type="checkbox"/> AUX. rear

- **Main exit floor:** If much of the traffic is exiting at a particular floor (i.e., the lobby), setting that floor number here will allow the system to assign calls so that floor receives the best possible service.



- **Non-peak hall call assignment penalty:** Favors demand down peak calls by adding the number of seconds entered here to their time of registration, making them appear to have been registered sooner and thus have more priority.
- **Peak hall call types:** If appropriate, allows you to select those risers on which down hall calls will be identified as demand down peak calls.

Parking

Create up to eight different Parking configurations. Each configuration tells iControl how and where to park the car when it is idle and how long to wait before parking an idle car at a lobby or non-lobby floor. Parking configurations are selected manually (Dispatching tab) or by timer table. The car will park only when idle and eligible to park, will re-park only if eligibility or parking configuration changes, and will un-park only if there is a change of status (i.e., hall call demand, car call demand, out-of-service, inspection, etc.).

System Configuration

Parking

- Building
- CFSS
- Dispatching
 - Options
 - Configurations
- Hall Call Eligibility
 - Bank A
 - Bank B
- Mode Of Operation
 - Automatic
 - Lobby peak detection
 - Lobby peak options
 - Demand peak detection
 - Demand peak options
 - Balanced
 - Lobby peak
 - Demand Up Peak
 - Demand Down Peak
 - Parking**
- Parking Eligibility
- Split Bank
 - Hall Call Riser
- Management
 - Remote Monitoring Authorization
 - Local Dispatcher

Select a parking configuration (1 thru 8) 1

Parking method Per floor parking

General

Enable sector dispatching

Parking options

Lobby parking delay 2 sec

Lobby shuffle delay 10 sec

Non-Lobby parking delay 20 sec

Non-Lobby shuffle delay 10 sec

Parking floors

Hall call demand dynamic parking

	Front Door Time	Rear Door Time
Lobby	Closed	Closed
Non-Lobby	Closed	Closed

Edit

User setting

Priority	Floor	Front Doors	Rear Doors

Edit
Remove
Add

10-20 Manual # 42-02-2222

Contents

Index

MCE Web

For each Parking configuration, users may choose to allow iControl to determine the optimal parking configuration at any given time or to manually define a parking floor (lobby or non-lobby for each configuration):

- **User setting:** On a per-configuration basis, the user defines priority (lobby or non-lobby) and car door behavior at the selected parking floor.
- **Dynamic:** iControl predicts building hall call demand and parks the car accordingly, determining optimal parking configuration on an ongoing basis
- **Combination:** The user programs essential floors only, leaving other floor entries blank. When acting as the Backup Dispatcher, once user-defined parking floors are served, iControl will park the remaining idle cars automatically.

Parking Configurations

1. Select a Parking configuration to edit/create (1 — 8). Screen information will automatically update when a configuration is selected.
2. Select a Parking method:
 - **Per floor parking:** Parking is assigned on a per floor basis.
 - **Sector parking:** The building is divided into a number of user-defined sectors (contiguous group of floors) and parking assignments are based on those sectors rather than upon individual floors. The Parking floors pane will change to indicate floors or sectors depending on the method selected. The user may also choose to enable Sector dispatching, causing the dispatcher to consider parking assignments and through-sector travel when making call assignments.

Set Parking Delay Timers

These delay timers are used by both user-defined and dynamic parking behaviors.

- **Lobby parking delay:** When a car becomes idle (no call demand), this parameter determines the minimum time before it may be moved to a lobby parking floor.
- **Lobby Shuffle delay:** When a lobby parking floor becomes available, this parameter determines the delay before requesting that a car parked at a non-lobby parking floor be shuffled to a lobby parking floor.
- **Non-lobby parking delay:** When a car becomes idle, this parameter determines the minimum time before it may be moved to a non-lobby parking floor. If no lobby or non-lobby parking floors are available, the car will remain idle at the last floor served.
- **Non-lobby shuffle delay:** When a car is parked at a non-lobby parking floor, this parameter determines the minimum time it must remain at that floor before it may be shuffled to a lobby parking floor.

The screenshot shows a window titled "Parking options" with four rows of settings, each consisting of a label, a numeric input field, and a unit "sec".

Label	Value	Unit
Lobby parking delay	2	sec
Lobby shuffle delay	10	sec
Non-Lobby parking delay	20	sec
Non-Lobby shuffle delay	10	sec

Parking delay timers ensure that the car is not constantly parked and re-parked in response to momentary system conditions.

Choose Dynamic or User-Defined Parking

If you enable only dynamic parking, iControl will automatically control parking behavior for the car. If you enable only user-defined parking, the floor selection assigned the highest priority will be the parking floor.



Note

Floors assigned a priority from 1 to 4 are recognized as lobby floors for purposes or door behavior.

If there is only one car in this “group,” you should assign only one floor per parking configuration. If you assign more than one floor, only the highest priority floor will be selected for parking. The priority setting is useful in assigning lobby (1-4) or non-lobby (5+) door behavior.

Parking floors

Hall call demand dynamic parking

	Front Door Time	Rear Door Time
Lobby	Closed	Closed
Non-Lobby	Closed	Closed

User setting

Priority	Floor	Front Doors	Rear Doors
1	1	Open	Closed
2	3	8 sec	Open
3	5	6 sec	5 sec

Dynamic Door Times Edit door behavior for cars parking at lobby and non-lobby floors:

1. With dynamic parking enabled, select either the Lobby or the Non Lobby row.
2. Click Edit.
3. Choose whether the car should park with front and/or rear doors closed, open, or open for a number of seconds, then closed.
4. Click OK after making settings.

Hall call demand dynamic parking

	Front Door Time	Rear Door Time
Lobby	Closed	Closed
Non-Lobby	Closed	Closed

Door Timers

Park with front doors

Closed

Open

Open for sec

Park with rear doors

Closed

Open

Open for sec

Per Floor Parking - User Defined Priority, Floor, and Door Times To select priority, parking floor, and door times manually when the Parking method is set to “Per floor parking”:

User setting

Priority	Floor	Front Doors	Rear Doors
1	1	Open	Closed
2	3	8 sec	Open
3	5	6 sec	5 sec

1. Select an entry row in the list and click Edit, or click Add if you are adding a new entry to an unfilled table. (You may assign as many parking/floor sets as you have cars in the group. If you want multiple cars to park at the same floor, set up multiple, identical entries for that floor.)

Parking Floors

Priority:

Floor:

Park with front doors

Closed

Open

Open for sec

Park with rear doors

Closed

Open

Open for sec

2. Assign a priority of 1 through 4 to the floor if you want it recognized as the lobby floor for this configuration.



Priorities 1 through 4 are treated as lobby parking floors (use lobby delay timers). Remaining priorities are treated as non-lobby floors. Start and End floor selections are active only when Sector parking has been chosen.

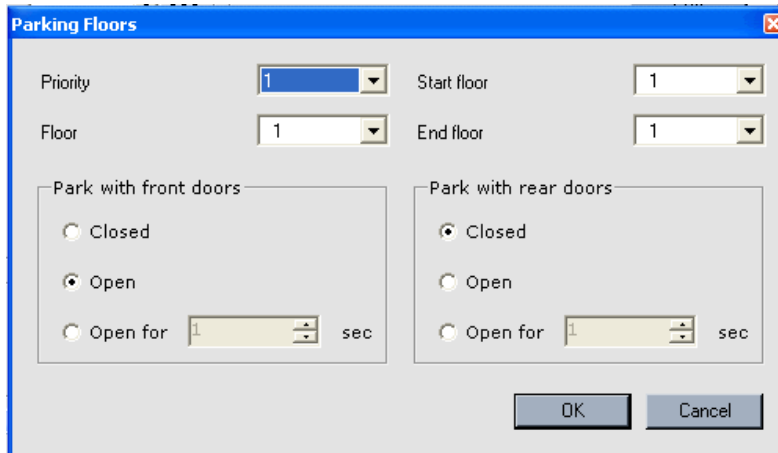
3. Select the parking floor.
4. Choose whether cars should park with front and/or rear doors closed, open, or open for a number of seconds, then closed.
5. Click OK after making settings.
6. Continue selecting and setting additional priority/floor sets as needed.

Sector Parking - User Defined Priority, Floor, and Door Times To define sectors, select priority, parking floor within the sector, and door times manually when Parking method is set to “Sector parking”:

User setting

Priority	Start Floor	Return Floor	End Floor	Frc
1	1	1	6	
2	7	7	15	

1. Select an entry row in the list and click Edit, or click Add if you are adding a new entry to an unfilled table. (You may assign as many parking/floor sets as you have cars in the group. If you want multiple cars to park at the same floor, set up multiple, identical entries for that floor.)



2. Select a Priority. The higher the priority, the more iControl will attempt to maintain a parked car in the sector. One (1) is the highest priority.

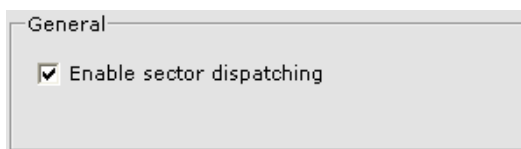
Note

Priorities 1 through 4 are treated as lobby parking sectors (use lobby delay timers). Remaining priorities are treated as non-lobby sectors.

3. Select the preferred parking floor within the sector.
4. Choose a starting floor (lowest) return floor and end floor (highest). This defines the sector.
5. Choose whether cars should park with front and/or rear doors closed, open, or open for a number of seconds, then closed.
6. Click OK after making settings.
7. Continue selecting and setting additional priority/floor sets as needed.

Sector parking conditions:

- Overlapping start and/or end floors are allowed.
- Cars without car or hall call demands will be immediately parked. If the idle car is in a sector that already has a parked car, it will move to the nearest unoccupied sector.
- Only one car may be parked in a sector at any one time.
- If a car-call demand stops a car in an unoccupied sector, and it is assigned to park, it will park at the floor of the demand (rather than moving to the preferred floor within the sector).
- If the dispatcher assigns a car to park in an unoccupied sector, but then detects a car-call registered to that sector for another car, the first car will not be moved (or will be stopped if already moving).
- If sector parking is selected for a parking configuration but the user does not define sectors, or defines fewer sectors than might be accommodated by the number of cars in the group or available landings, the dispatcher will make sector parking assignments dynamically using artificial intelligence. Under these conditions:
 - The number of landings assigned to a sector will vary according to traffic demands. For example, during up peak operation, the upper sector will be extended so that any down demand may be more effectively met by the car assigned to park in the sector, while up demand is met by other cars in the group.
 - The dispatcher will adjust behavior depending upon traffic data collected from previous experience during the same timer periods. For example, if hall call demand at a particular floor has been historically heavy during certain times, a car or cars will be moved to or near those floors in anticipation of the demand.
 - If previous experience during a particular time so indicates, the dispatcher will anticipate the destination of hall call demand from a particular floor or floors and will reassign parking for idle cars at anticipated destination floors accordingly.

Sector Dispatching

When the parking method is set to Sector, and Sector dispatching is enabled, the dispatcher will consider user-defined and/or dynamically assigned parking sectors when making dispatching decisions (refer to sector parking conditions above).

Enable sector dispatching is only suitable for Group dispatching and is not applied on Simplex operation. For a Simplex car, when Sector dispatching is enabled and used in conjunction with Sector parking, this option will cause the simplex car to park in the nearest available sector rather than in the highest priority sector.

Combine Dynamic and User-Defined behaviors: To use both dynamic and user-defined behaviors:

1. Enable both dynamic and user-defined capabilities.
2. Set lobby and non-lobby floor dynamic door behavior as described previously (Dynamic Door Times).
3. Define essential floors or sectors, priority, and door behavior manually as described previously (User Defined Priority). (Remember that 1 through 4 priorities are treated as lobby floors/sectors.)

Parking floors

Hall call demand dynamic parking

	Front Door Time	Rear Door Time
Lobby	Closed	Closed
Non-Lobby	Closed	Closed

User setting

Priority	Floor	Front Doors	Rear Doors
1	1	Open	Closed
2	3	8 sec	Open
3	5	6 sec	5 sec

4. If necessary, remove any unneeded user-defined entries from the table because all user-defined parking floors must be satisfied before the dynamic parking will begin to park cars.

Sending Changes to iControl

As you define Parking configurations, you can send them to iControl at any time using the Send button. To send changes, you must have acquired write privileges first (*Write privilege menu/Acquire*).

Note

Parking configurations interact with and respond to choices made in Parking Eligibility configurations. [Please refer to "Parking Eligibility" on page 10-27.](#)

Parking Eligibility

For a Simplex car, Swing car or Local/Dispatcher, create up to eight Parking Eligibility configurations. Each configuration determines how the car is allowed to park: Not park at all/local park/or park according to the Parking configurations.

Note

Parking configurations determine how the car is parked according to demand and priority. Parking Eligibility configurations determine parking restrictions and behavior as they apply to the car.

If a car is ineligible to park at a particular floor, it will not be moved to that floor to satisfy a parking demand. However, if a car is at a normally ineligible floor in response to a car or hall call, it may remain at that floor. If a car is parked at an eligible floor when the Parking Eligibility configuration is changed manually or via automated timer such that the car is no longer eligible to park at that floor, the cars “parked” status is removed but the car itself will not be moved except by car call, hall call, or other parking demand (active under the new configuration).

Select a parking eligibility configuration (1 thru 8)

Select car

This car is allowed to park

Not at all

At floor

Front door time Closed

Rear door time Closed

Per parking configuration (this car is eligible to park at floors)

Floor label	Eligible	Front Doors	Rear Doors
8	✓		
7	✓		
6	✓		
5	✓		
M	✓		
L	✓		
S	✓		
SB	✓		

To program a Parking Eligibility configuration:

1. Select a Parking Eligibility configuration to edit/create (1 – 8).
2. Verify the car for which you want to set parking specifics.
3. If the car is not allowed to park when this configuration is active, select Not at all.
4. If the car is allowed to park only at a specific floor, set that floor, then click Edit to set door behavior. In this instance, the elevator controller will be responsible for parking the car — Parking tab configuration timers will not apply. [Please refer to “Parking Configurations” on page 10-21.](#)
5. If the car is eligible to be parked according to the Parking configurations, select Per parking configuration. The table below the selection will become active when Per parking configuration is active. If you select this choice, also set the floors at which the car is eligible to be parked and front, rear, or both doors access at that floor.

 Note

If a car is set to be eligible to be parked according to the Parking configurations, it must be made eligible to park at some floor in the building (by selection in the table). It cannot be ineligible to park at every floor and yet be included in Parking configurations. [Please refer to “Parking” on page 10-20.](#)

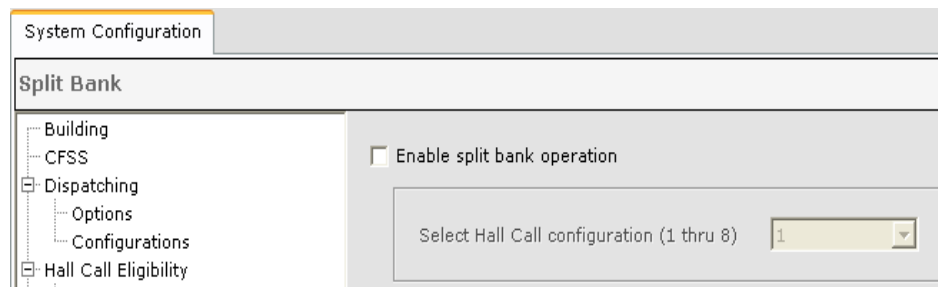
6. Click *Send* to send changes to iControl.
7. Repeat for additional configurations or if this car is the designated Backup Dispatcher, for additional cars.

Split Bank Operation

Split Bank operation allows one or more cars of a group system to provide special operations in some aspects of car operation, dispatching or parking. Split Bank is typically used for freight cars, express service, dining service, shuttle service, dual-parking schemes or to dispatch a car with one bank or the other based on average wait times (to reduce wait times). Split Bank operation requires the use of a Central Dispatcher.

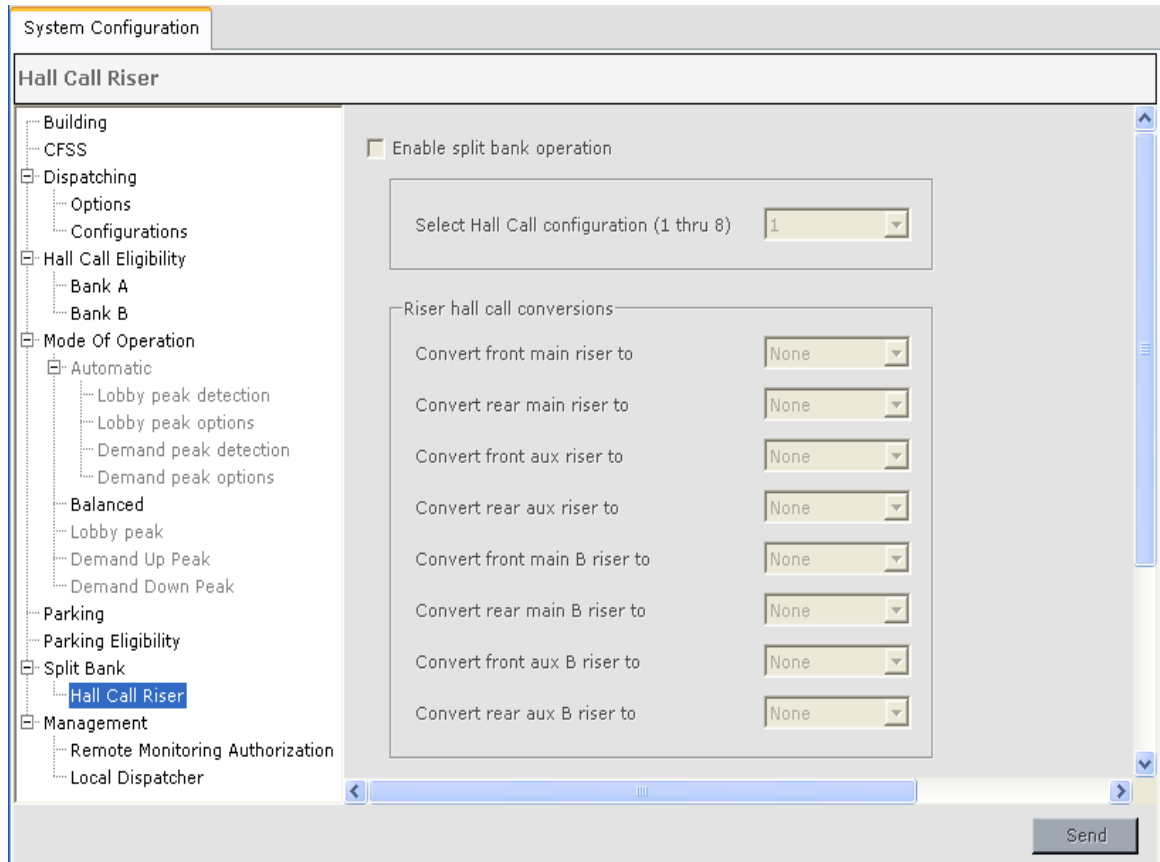
When Split Bank operation is enabled and active, the elevator group is effectively split into two separate groups, each called a “bank.” Hall call eligibility, per car and per hall call eligibility configuration for each bank, is separately configurable. When split bank operation is enabled and active, split bank cars use the Bank B hall call eligibility. (Please refer to “Hall Call Eligibility” on page 10-13.) During split bank operation, Bank B car risers may also be reassigned. Emergency power and Security settings are not affected by Split Bank selection. When Split Bank operation is deactivated, all group cars return to using the Bank A hall call eligibility assignments.

- Split Bank operation may be activated through iView manually by selecting manual assignment and the appropriate hall call eligibility configuration on the Dispatching screen Configuration tab. Split bank must be enabled.
- Split Bank operation may be activated by timer selection of a hall call eligibility configuration when split bank is enabled.
- Split Bank operation may be activated manually by switch input. (Highest activation priority rests with this switch.) Split bank must be enabled.
- Split Bank operation may be deactivated manually by switch input. (Highest deactivation priority rests with this switch. When this switch is active, regardless of how Split Bank activation was invoked, it will be shut off.)



- **Enable split bank operation:** When this box is checked, Split Bank operation is enabled. Though enabled, it may or may not be active. It can be made active as described above.

- **Select Hall Call Configuration (1 thru 8):** Select a Hall call configuration here, then click on the Hall Call Riser tab to modify hall call riser assignments when split bank operation is active and this hall call configuration is in use.



- **Convert “xxx” riser to:** In the selection boxes, pick the risers to be emulated as appropriate to your installation when the displayed hall call configuration is active.

Management

Provides access to Remote Monitoring Authorization and Local Dispatcher.

Remote Monitoring Authorization

Use to authorize a third party remote monitoring tool to connect to iControl.

System Configuration

Remote Monitoring Authorization

To allow remote monitoring software to connect to the system please call MCE at 1-800-444-7442.

Be ready to provide the type of monitoring system and the hardware key for each iCue/iController to be connected.

Activate

Hardware key

Activation code -

Activated Clients

To activate Third Party Monitoring:

1. Call MCE to obtain the Activation code. You will need to indicate the type of monitoring system and hardware key for each iCue/iController to be connected.
2. Enter the Activation code supplied by an MCE representative.
3. Click the *Activate* button.
4. If the connection has been authorized, the name of the monitoring system is added to the Activated Clients list.

To deactivate Third Party Authorization:

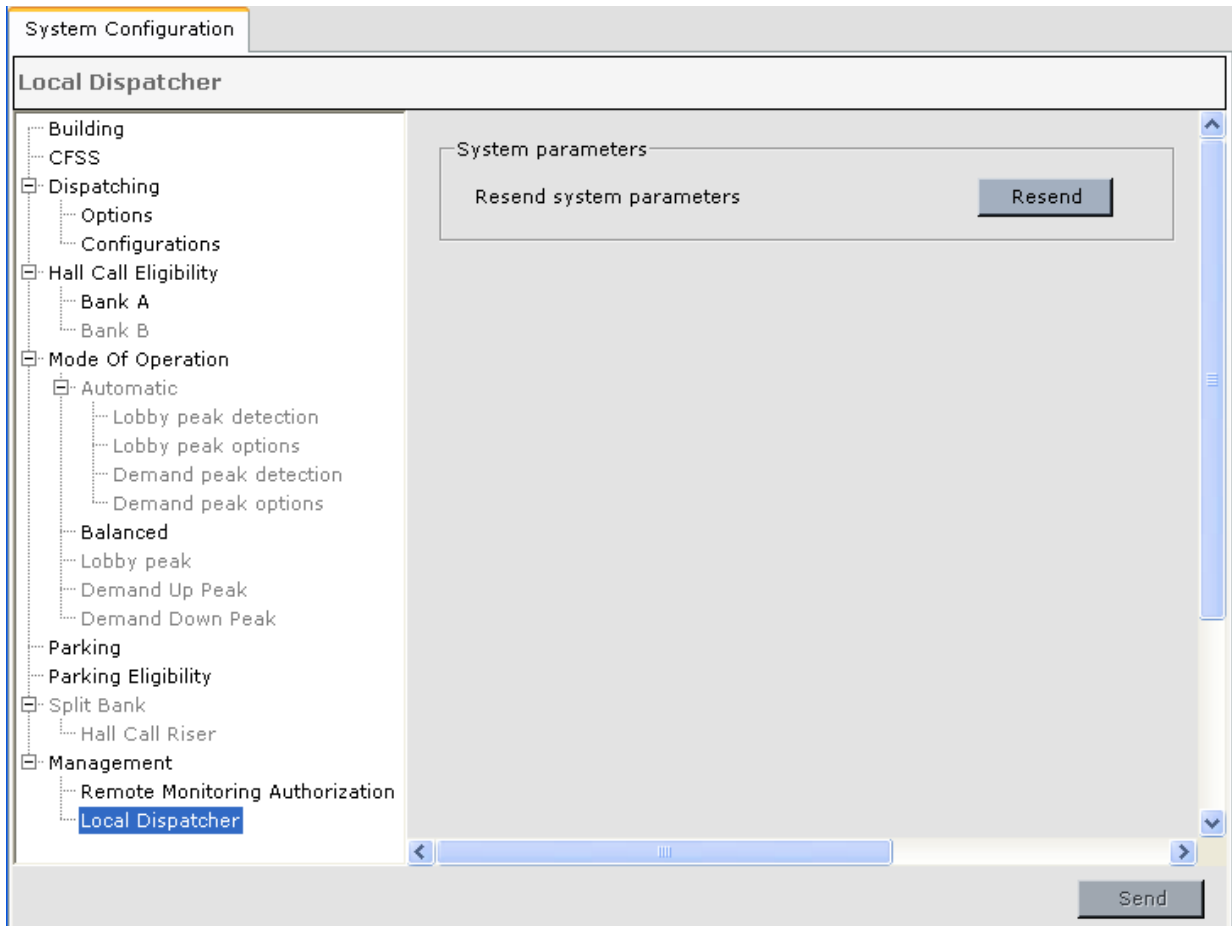
1. Enter the activation code for the monitoring system you wish to deactivate.
2. Click the *Deactivate* button.
3. The name of the monitoring system is removed from the Activated Clients list.

Note

The Activation code is unique for each iControl installation.

Local Dispatcher

Normally the system parameters are passed automatically to all cars designated as Alternate Dispatcher. This tool is used to command the system to resend the parameters.



System parameters Click the **Resend** button to command the system to resend the system parameters to all cars designated as Alternate Dispatcher. Any cars which are not in operation will receive the updated system parameters when they are powered up and communication with the dispatcher is reestablished.

Configuration Tabs - Emergency Power

The Local Dispatcher can manage emergency power from one or two emergency generators. Use these controls to indicate which cars are connected to each generator and to define how switching to and from emergency power is handled. The sequence of Emergency Power Operation is as follows:

1. Upon loss of commercial power, as indicated by the *Emergency power input*, no cars are permitted to run until power from the emergency generator is established and the *After emergency power comes on, time to wait before running the cars* time has elapsed.
2. **Emergency Power Recall** - During recall, cars are powered and returned to their recall floor (set on Controller > Configuration > Car Operation > Emergency power tab) as defined by the Emergency Power Recall parameters. (Cars on Fire Service, Test or Earthquake operation may be recalled to other floors per code requirements).
3. **Emergency Power Run** - When recall is completed, cars are allowed to run on emergency power as defined by the Emergency Power Run parameters.
4. **Power Transfer** - Activation of the *Power transfer input* indicates that commercial power is about to be restored. All cars are commanded to stop and/or not move until transfer to commercial power is completed.

System Configuration
Emergency Power

Cars Assigned To

Generator 1

1
2
3
4

→

Generator 2

←

Generator 1

Emergency Power Input

Active low Active high

After Emergency power comes on, time to wait before running the cars: sec

Emergency Power Recall

Activate recall by the Auto recall selection switch input

Always recall

Never recall

Recall sequence: Up
Down

Number of cars that can be recalled at the same time:

Recall Timeout: sec

At a minimum, recall to the next floor

Emergency Power Run

Activate run by the Emergency power auto run input

Always run

Never run

Run sequence: Up
Down

Number of cars that can be run at the same time:

Last car to be recalled shall be the first car to run

Generator 2

Emergency Power Input

Active low Active high

After Emergency power comes on, time to wait before running the cars: sec

Emergency Power Recall

Activate recall by the Auto recall selection switch input

Always recall

Never recall

Recall sequence: Up
Down

Number of cars that can be recalled at the same time:

Recall Timeout: sec

At a minimum, recall to the next floor

Emergency Power Run

Activate run by the Emergency power auto run input

Always run

Never run

Run sequence: Up
Down

Number of cars that can be run at the same time:

Last car to be recalled shall be the first car to run

[Contents](#)
[Index](#)
[MCE Web](#)

10-33

10

Assign Cars To Using the controls at the top of the screen, select cars and use the arrow buttons to place them in the Generator 1 or Generator 2 column. The cars must be physically wired to receive their emergency power from the selected generator.

Defining Emergency Power Behavior

The Generator 1 and Generator 2 controls allow you to define emergency power parameters for each generator individually.

Emergency Power Input Set the *Emergency power input* to be active high (120VAC) or active low (0VAC) as required by the job.

- **After Emergency Power comes on, time to wait before running the cars:** Set the amount of time to wait, after switching to emergency power, before initiating the Recall phase. This allows emergency power to stabilize. Set this time long enough to allow the controllers to establish communication with the dispatcher.

Emergency Power Recall Based on the *Number of cars that can be recalled at the same time* parameter, cars are selected to recall as follows:

1. Cars with a *Priority Recall Request* status, e.g. heavily loaded cars, are recalled in the order they appear on the *Recall sequence* list.
2. All remaining cars are recalled in the order they appear on the *Recall sequence* list.
3. A second attempt is made to recall any cars unsuccessfully recalled.

These parameters define Emergency Power Recall behavior.

- **Activate recall by the Auto recall selection switch input:** If this option is selected, Emergency Power Recall will be activated if the *Auto recall selection switch input* is active when the *After emergency power comes on, time to wait before running the cars* time elapses. Otherwise, Emergency Power Recall will be skipped.
- **Always recall:** Emergency Power Recall will always be activated when the *After Emergency power comes on, time to wait before running the cars* time elapses.
- **Never recall:** The Recall phase is always skipped.



Note

Some Fire codes require a car that is on Fire Service to be recalled on Emergency Power regardless of the options selected.

- **Recall Sequence:** Cars are recalled in the order in which they appear in this list. Select a car and use the Up/Down buttons to order the list.
- **Number of cars that can be recalled at the same time:** Set the number of cars that may be recalled at the same time, considering generator capabilities and elevator car and other building power demands.
- **Recall Timeout:** If a car fails to respond to a recall signal within this time, the car will be placed Out of Service.
- **At a minimum, recall to next floor:** This option permits cars to be recalled to the nearest floor to prevent entrapments if the Recall phase would instead be bypassed. The Recall phase is bypassed if one of the cars is manually selected to run, *Activate recall by the Auto recall selection switch* is selected but the *Auto recall selection switch input* is not active, or *Never recall* is selected.

Emergency Power Run Based on the *Number of cars that can be run at the same time* parameter, cars are selected to run as follows:

- **Manual selection** - cars are selected to run in the order they appear on the *Run sequence* list as follows:
 1. Cars with a *Priority Run Request* status (e.g. EMS phase 2, CFSS phase 2 and Fire Service Phase II), that also have their *Emergency power run input* active.
 2. Cars that have their *Emergency power run input* active.
- **Automatic selection** - If *Always run* is selected, or if *Activate run by the Emergency power auto run input* is selected and the *Emergency power auto run input* is active, cars are selected to run in the order they appear on the *Run sequence* list as follows:
 3. Cars with a *Priority Run Request* status, e.g. EMS phase 2, CFSS phase 2 or Fire Service Phase II.
 4. If *Last car to be recalled shall be the first car to run* parameter is selected, that car is chosen to run at this time, if it hasn't already been selected.
 5. All other cars.

Choose one of the following three parameters to determine the method used to activate automatic selection of cars to run on emergency power.

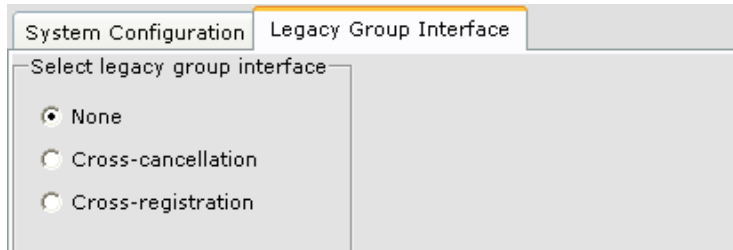
- **Activate run by the Emergency power auto run input:** Cars are selected to run as indicated in Automatic selection above.
- **Always run:** Cars are selected to run as indicated in Automatic selection above.
- **Never run:** Cars are not automatically selected to run on emergency power.
- **Run Sequence:** Cars are selected to run in the order in which they appear in this list. Select a car and use the Up/Down buttons to order the list.
- **Number of cars that can be run at the same time:** Set the number of cars that may be run at any one time, considering generator capabilities and elevator and other building demands. Typically set to run one car.
- **Last car to be recalled shall be the first car to run:** The last recalled car is selected to run as indicated in 4 above.

Power Transfer This phase, initiated by the activation of the “Power transfer input”, indicates that commercial power is about to be restored. Cars that are moving on emergency power are commanded to stop at the next available floor to avoid an emergency stop. No cars are permitted to move until transfer to commercial power is completed.

If the Power transfer input is deactivated, and commercial power has not been restored, the system will return to the Emergency Power phase it was operating in prior to the Power transfer input being activated.

Configuration Tabs - Legacy Group Interface

During building modernization, it may be desirable to retain the legacy dispatcher and some of the legacy controllers a period of time. To accomplish this, iControl provides two options, cross-registration and cross-cancellation. These options are available only on the central dispatcher (iCentral) running the iCue dispatching software.

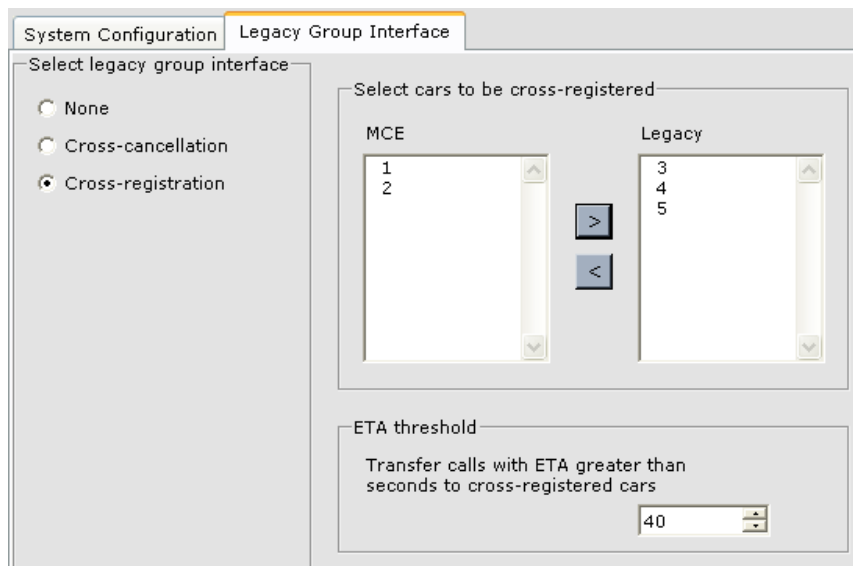


- **Select legacy group interface:** Use this control to select the legacy group interface option being used, Cross-cancellation, Cross-registration or None.

Cross-registration

With Cross-registration, the iControl central dispatcher (iCentral) receives the hall calls and manages the dispatching based on the following:

1. If an iControl car is available and can answer the call within the user adjustable “ETA threshold” time, the hall call is assigned to an iControl car.
2. All other hall calls are passed to the legacy dispatcher provided that a legacy car that can answer the call, per the eligibility map, is in service.



- **Select cars to be cross-registered:** Indicates which cars are MCE iControl and which are legacy cars. Select those legacy cars that are to be cross-registered and use the right arrow to place them in the “Legacy” list.

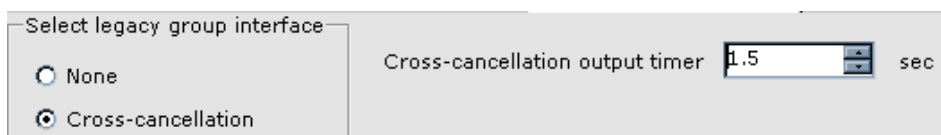
- **ETA threshold:** If an iControl car is available and can answer a call within the ETS threshold time, the call is assigned to the iControl car. Otherwise the call is passed to the legacy dispatcher.

Note

When using cross-registration, care must be taken to ensure that the hall call eligibility (System > Configuration > Hall Call Eligibility) for the legacy cars is correct so that the iControl central dispatcher knows whether the car has proper access privileges.

Cross-cancellation

With cross-cancellation, the legacy dispatcher receives the hall calls and assigns them to legacy cars. The legacy dispatcher also passes the calls, via a relay closure corresponding to the riser and direction of the call, to the iControl central dispatcher (iCentral) which assigns the calls to iControl cars. If the iControl car is first to answer the call, the central dispatcher signals the legacy dispatcher to cancel the call, and vice versa.



The screenshot shows a configuration window titled "Select legacy group interface". On the left, there are two radio buttons: "None" (unselected) and "Cross-cancellation" (selected). On the right, there is a label "Cross-cancellation output timer" followed by a numeric input field containing "1.5" and a unit label "sec".

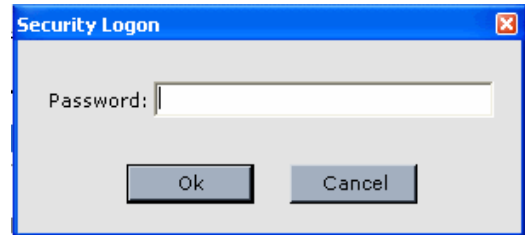
- **Cross-cancellation output timer:** (de-bounce for the “call answered” output) When the legacy dispatcher sees the relay closure indicating that an iControl car has answered a call, it takes some finite time to recognize and process the signal, at which point it cancels the hall call demand. iControl then waits for the duration set in this timer before dropping its “call answered” closure. This delay prevents the legacy system from misinterpreting the relay state change as “call not yet satisfied.”

Configuration Tabs - Security

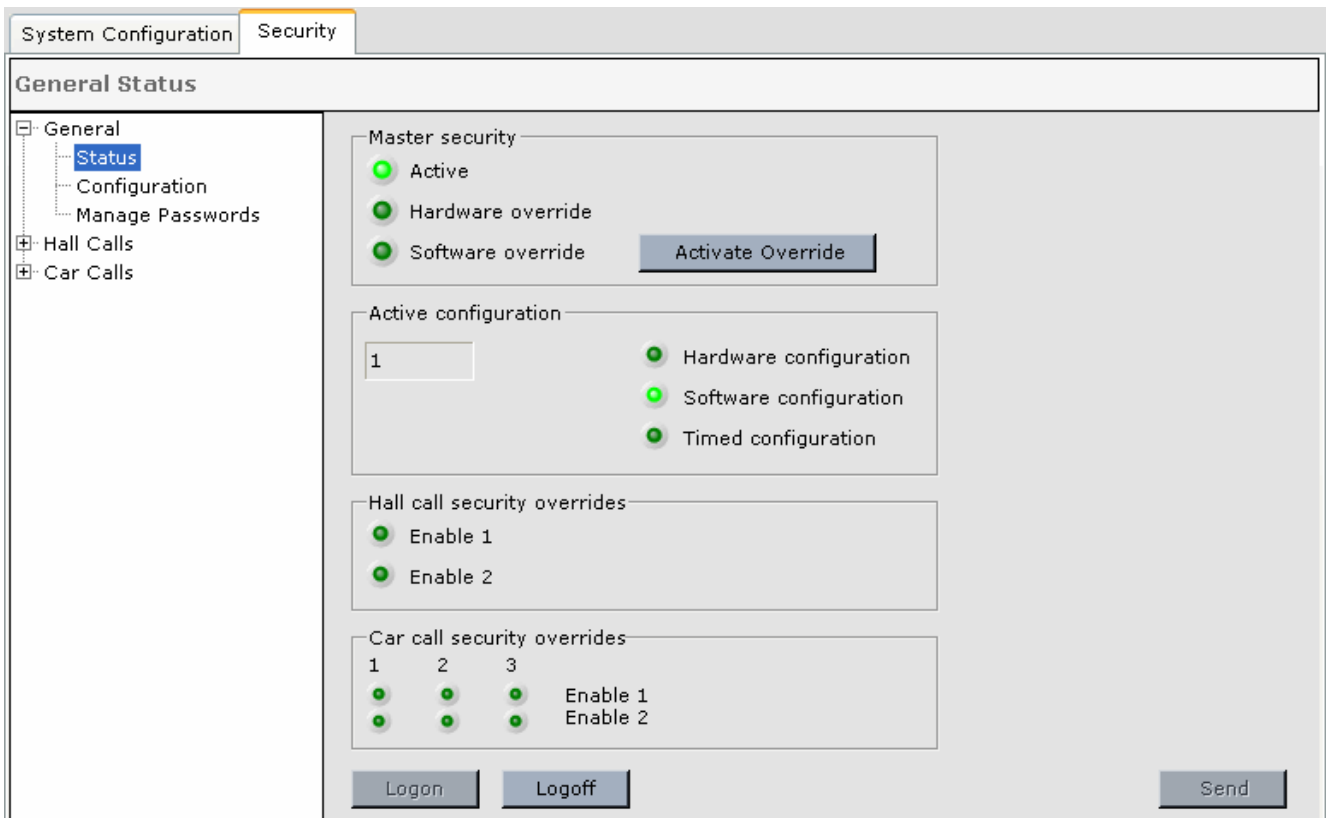
These parameters control elevator security by restricting hall and car call registration. For local cars, operating under the direction of a central dispatcher (iCentral) or a Local/Dispatcher, elevator security is controlled by settings made while iView is connected to iCentral or the Local/Dispatcher. The parameters are stored on iCentral or the Local Dispatcher and are copied to all Alternate Dispatchers. However, when the controller is configured as a simplex or swing car, the security parameters are stored on the simplex or swing car controller. To change the parameters iView must be connected to the simplex or swing car controller.

When you select System > Security, the General > Status tab is displayed. Access to security settings beyond viewing the general status is restricted to authorized users. There are two user classes, manager and technician. The manager is allowed to set up and edit passwords, the technician is not. To log on:

1. Click the *Logon* button at the bottom of the screen. The Logon dialog is displayed.
2. Enter the manager or technician password. (Factory default passwords are “manager” for manager logon and “technician” for technician logon.)
3. Click Ok. The menus that were previously grayed-out will become available.



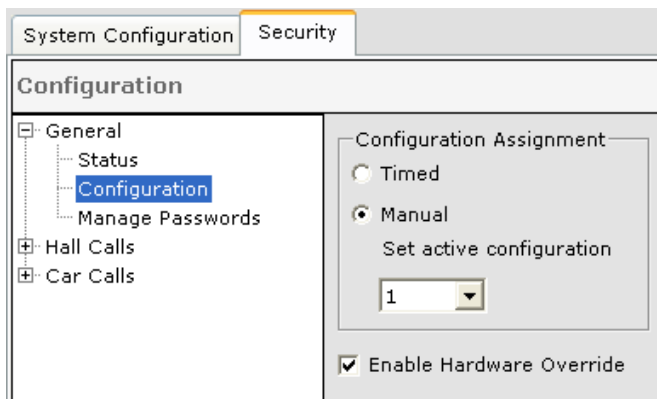
General - Status



The Status screen provides an overview of currently active security settings.

- **Master security:**
 - Active: Lights if any security mode is active.
 - Hardware override: Lights if security has been overridden by a switch input.
 - Software override: Lights if security has been overridden by a software selection.
 - Activate Override button: Activates software security override. Button caption changes to Deactivate Override when override is activated.
- **Active configuration:**
 - Display: Indicates the currently active security configuration.
 - Hardware configuration: Lights if configuration was activated by a hardware switch.
 - Software configuration: Lights if configuration activated by software setting.
 - Timed configuration: Lights if configuration activated by system timer created using the Configuration > Timer Tables tab.
- **Hall call security overrides:**
 - Enable 1: Lights if hall call enable 1 input is activated by a card reader or keypad, etc. (System View > Configuration > System I/O - System tab - Hall call enable 1 inputs).
 - Enable 2: Lights if hall call enable 2 input is activated by a card reader or keypad, etc. (System View > Configuration > System I/O > System tab - Hall call enable 2 inputs).
- **Car call security override:**
 - Enable 1: Lights if a Car call enable 1 input is activated by a card reader or keypad, etc. (Controller > Configuration > I/O Boards > MIAC or COP - Car call enable 1 inputs).
 - Enable 2: Lights if a Car call enable 2 input is activated by a card reader or keypad, etc. (Controller > Configuration > I/O Boards > MIAC or COP - Car call enable 2 inputs).

General - Configuration



This tab allows you to set the active security configuration manually or by timed assignment and to Enable Hardware Override.

To set the security configuration manually

1. Select *Manual* in Configuration Assignment.
2. Set the desired configuration in the drop-down list.
3. Click Send.

To have the active security configuration set by timer table

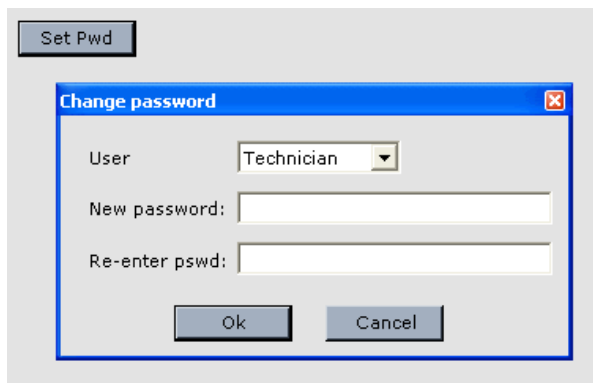
1. Select *Timed* in Configuration Assignment.
2. Click Send.
3. Program one or more timer tables (System > Configuration > Timer tables tab).

Enable Hardware Override: The Security override - Master security override input is ignored unless this control is activated.

General - Manage Passwords

Only the “manager” can set passwords. To change the password settings:

1. Logon using the manager’s password. If you are changing the passwords from their initial settings, logon using the default password “manager”.
2. Display the Manage Passwords tab (General > Manage Passwords).
3. Click the *Set Pwd* button. The Change password dialog is displayed.



4. Select the User (Manager or Technician) who’s password is to be changed.
5. Enter the new password in the “New password:” text box.
6. Re-enter the new password in the “Re-enter pswd:” text box.
7. Click OK.

Note

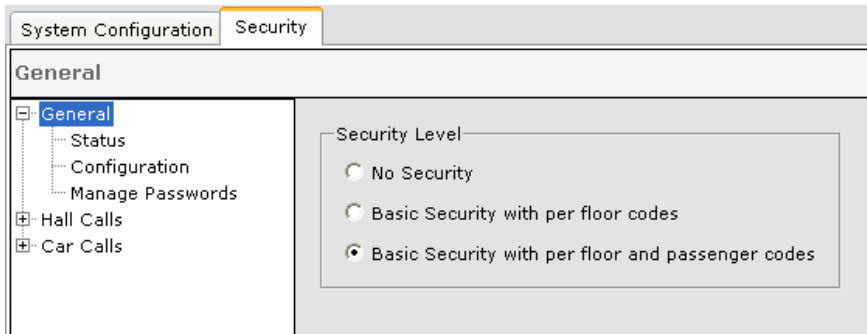
If you forget the password, locate the job number and/or serial number of the controller and contact MCE Technical Support at 916-463-9200.

Note

In order to activate security, physical device (card reader, key switch, etc.) inputs must be properly configured and wired. [Please refer to “Configuration - I/O Boards” on page 9-100.](#)

Security - General

The Security Level is set on the System > Configuration > Security > General screen.



The following Security Level options are available:

- **No Security:** Security is not being used.
- **Basic Security with per floor codes:**
- **Basic Security with per floor and passenger codes:**



Hall Calls

iControl security provides two types of hall call restrictions:

- **Per-Floor Security:** Places restrictions on hall call riser access on a per-floor basis.
- **Per-Car Lock Out:** Specifies which cars may stop at particular floors.

Per-Floor Security

Hall calls may be Unlocked, Locked or Secured:

- **Unlocked:** Unrestricted access. Calls may be registered.
- **Locked:** No access. Calls may not be registered.
- **Secured:** Access is restricted to authorized passengers. Calls may be registered after proper authorization (i.e., card reader, key switch, or code entry).

To set hall call security restrictions:

1. Select **Per-Floor Security** (System > Security > Hall Calls > Per-Floor Security).

Per-Floor Security

General

Security input latch time sec

Hall call enable 1 inputs active high

Allow parking at secured hall call

Hall call enable 2 inputs active high

Allow parking at partially locked floor

Configuration

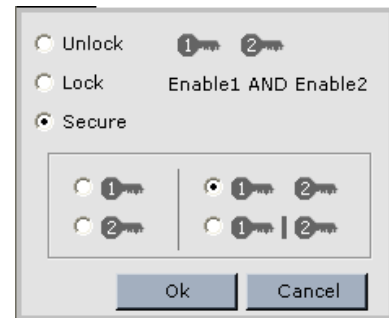
Floor label	Main				Auxiliary				CFSS			
	Front		Rear		Front		Rear		Front		Rear	
	Up	Down	Up	Down	Up	Down	Up	Down	CFSS1	CFSS2	CFSS1	CFSS2
17												
16												
15												
14												
13												
12												
11												
10												
9												
8												
7												
6												
5												
M												
L												
B												
SB												

Set Selection

Logon Logoff Send

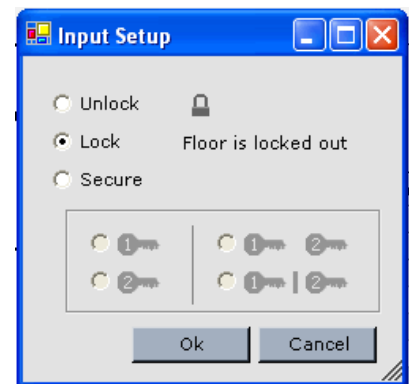
2. **Configuration:** Select the security Configuration (1 - 8) to which the hall call security restrictions apply.
3. For the hall call type (i.e., Main, Auxiliary, etc.) and location (Front/Rear), click in the table at the floor and direction (up/down) to be set.

4. In the selection list that appears, select the desired security condition (Unlock/ Lock/ Secure), and click OK.
5. If Secure is selected, chose the desired enable method(s) that will allow calls to be registered, and click OK.
 - Enable 1: Hall call enable 1 input activation.
 - Enable 2: Hall call enable 2 input activation.
 - Enable 1 AND Enable 2: Activation of both Hall call enable 1 and Hall call enable 2 inputs.
 - Enable 1 OR Enable 2: Activation of either Hall call enable 1 or Hall call. enable 2 input.



Alternate selection methods

- Click in a floor label in the Floor column to select all call types for that floor.
 - Click a column heading, e.g. Main, Main Front or Main Front Up to select that type of call for all floors.
 - Click and drag to select multiple floors and/or multiple columns (call types).
 - Once the floor(s) and call type(s) are selected, click the *Set Selection* button. The Input Setup dialog is displayed.
 - Select the desired security condition as described in steps 4 and 5 and click OK.
6. When you have the hall call security settings as desired, click *Send* to send the settings to iControl.



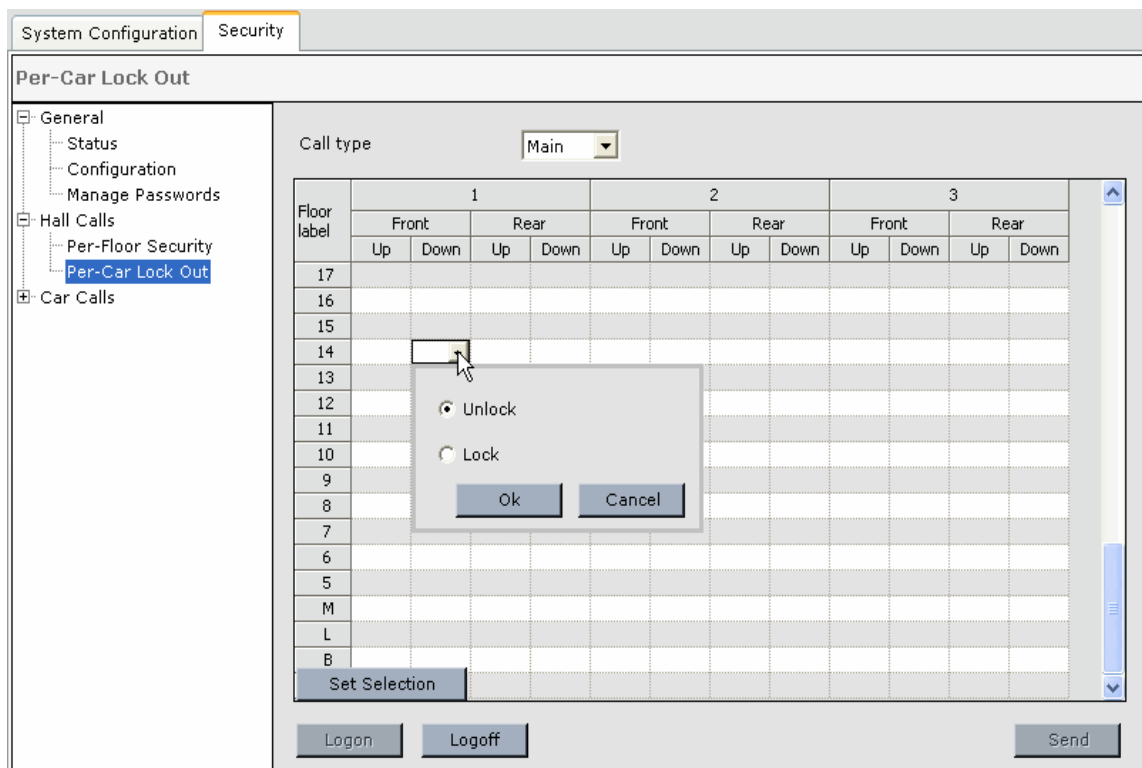
Other controls - General

- **Security input latch time:** Hall call enable inputs can be activated by a card reader or key switch, etc. Card readers typically hold the enable input activated for a period of time so that the user has time to enter the desired call. However, if a momentary switch or key switch is used to activate the hall call enable input, this control allows you to set the length of time that the user has to enter the call, after the hall call enable input has been deactivated.
- **Hall call enable 1 (or 2) inputs active high:** These controls allow you to program the hall call enable inputs to activate on either a low or high going signal.
- **Allow parking at secured hall call:** Cars are not allowed to park at a floor that is secured for hall calls unless this control is checked.
- **Allow parking at a partially locked floor:** Cars may park at a floor where some hall calls are locked, e.g. down hall calls locked but up hall calls are allowed.

Per-Car Lockout

On a per-car, per-floor, per-direction basis, this control determines which cars may respond to the various hall call types.

1. Select **Per-Car Lock Out** (System > Security > Hall Calls > Per-Car Lock Out).



- Note: Any calls that have been locked by Per-Floor Security settings will be indicated by light gray locks. Any calls that are also locked by Per-Car Lock Out settings will have a second dark gray lock added indicating the per-car settings.
2. **Call type:** Select a call type, Main, AUX or CFSS.
 3. **Floor, Car, Front/Rear, Up/Down:** The car numbers are at the top of the columns. Click in the row and column that selects the floor, car, front/rear, up/down hall call desired.
 4. Click **Lock** or **Unlock** and OK in the dialog that appears.

Alternate selection methods

- Click in the Car box to select all floors and directions. Or, click in the Riser box to select all calls for that riser.
- Choose the desired setting
- Click OK to set all selected calls the same.

Or,

- Click and drag in a column or row to make multiple selections.
- Click Set Selection.
- Choose the desired setting and click OK to set all selected calls the same.
- Click send to save your settings to iControl.

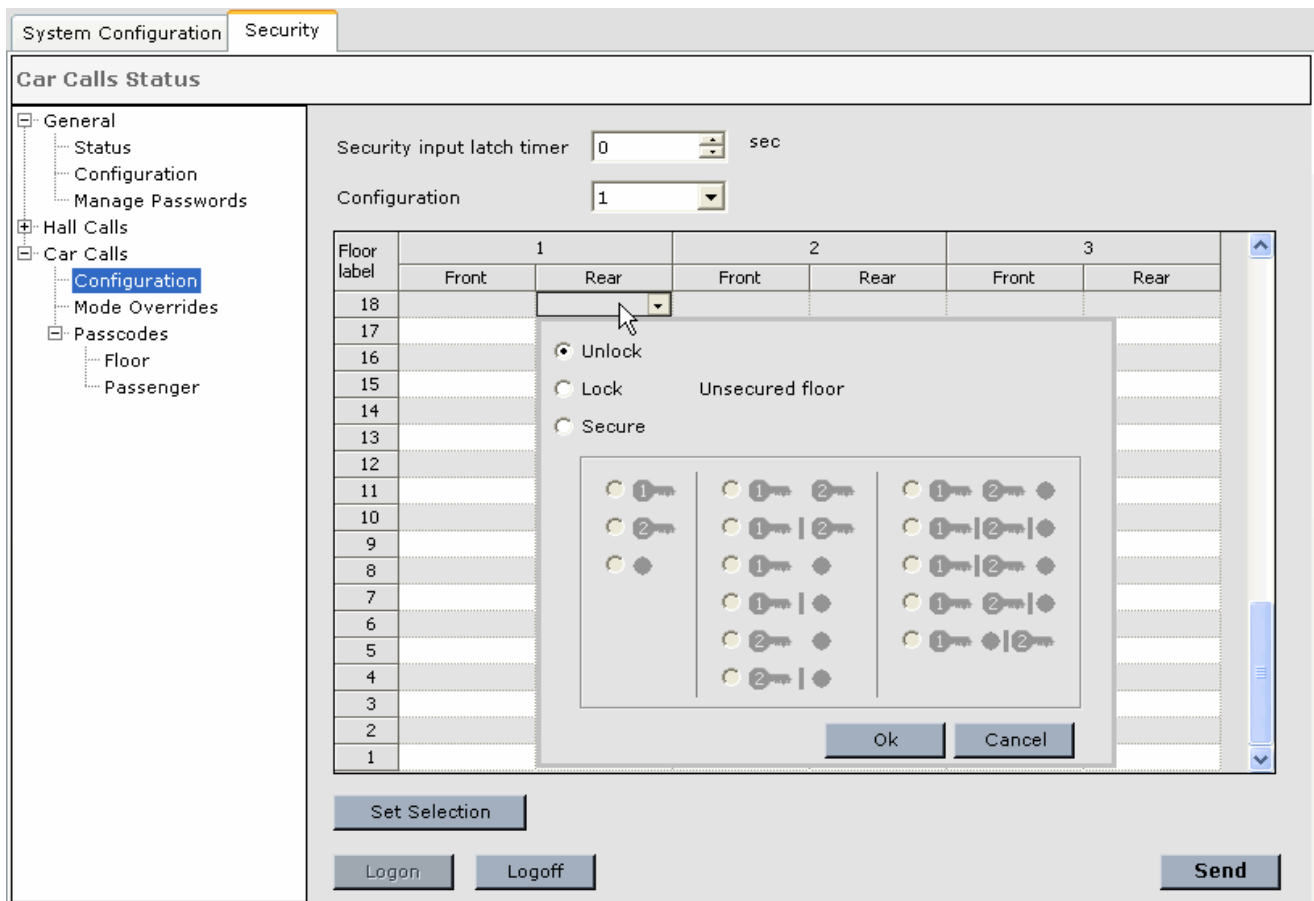
Car Calls - Configuration

Car calls may be Unlocked, Locked or Secured:

- **Unlocked:** Unrestricted access. Calls may be registered.
- **Locked:** No access. Calls may not be registered.
- **Secured:** Access is restricted to authorized passengers. Calls may be registered after proper authorization (i.e., card reader, key switch, or code entry).

To set car call security restrictions:

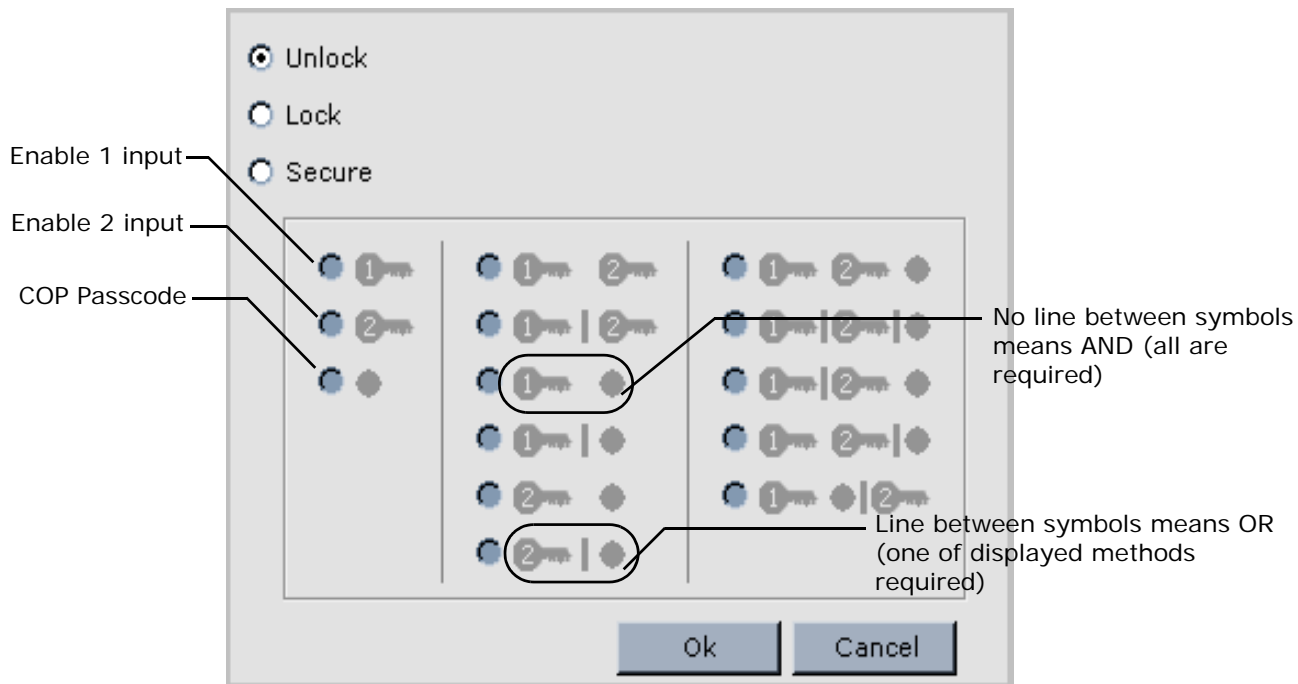
1. Display the System > Security > Car Calls > Configuration.



2. Select the security Configuration (1 - 8) to which the car call security restrictions apply.
3. For the car call type (front/rear), click in the table at the floor and car panel location (front/rear) to be set.
4. In the selection list that appears, select the desired security condition (Unlock/Lock or Secure).
5. If Secure is selected, choose the desired enable method or methods that will allow car calls to be registered.
 - Enable 1: Car call enable 1 input activation.
 - Enable 2: Car call enable 2 input activation.
 - COP Passcode: Passcode entered via the Car Operating Panel buttons.
 - A combination of the above (see Security Symbols on the next page).

Security Symbols

• This illustration explains the car call security symbols



Alternate selection methods

- Click in a floor label in the Floor column to select all call types for that floor.
 - Click a column heading, e.g. Front, Rear or both to select that type of call for all floors.
 - Click and drag to select multiple floors and/or multiple columns (call types).
 - Once the floor(s) and call type(s) are selected, click the *Set Selection* button. The Input Setup dialog (similar to the list shown above) is displayed.
 - Select the desired security condition as described in steps 4 and 5 and click OK.
6. When you have the car call security settings as desired, click *Send* to send the settings to iControl.

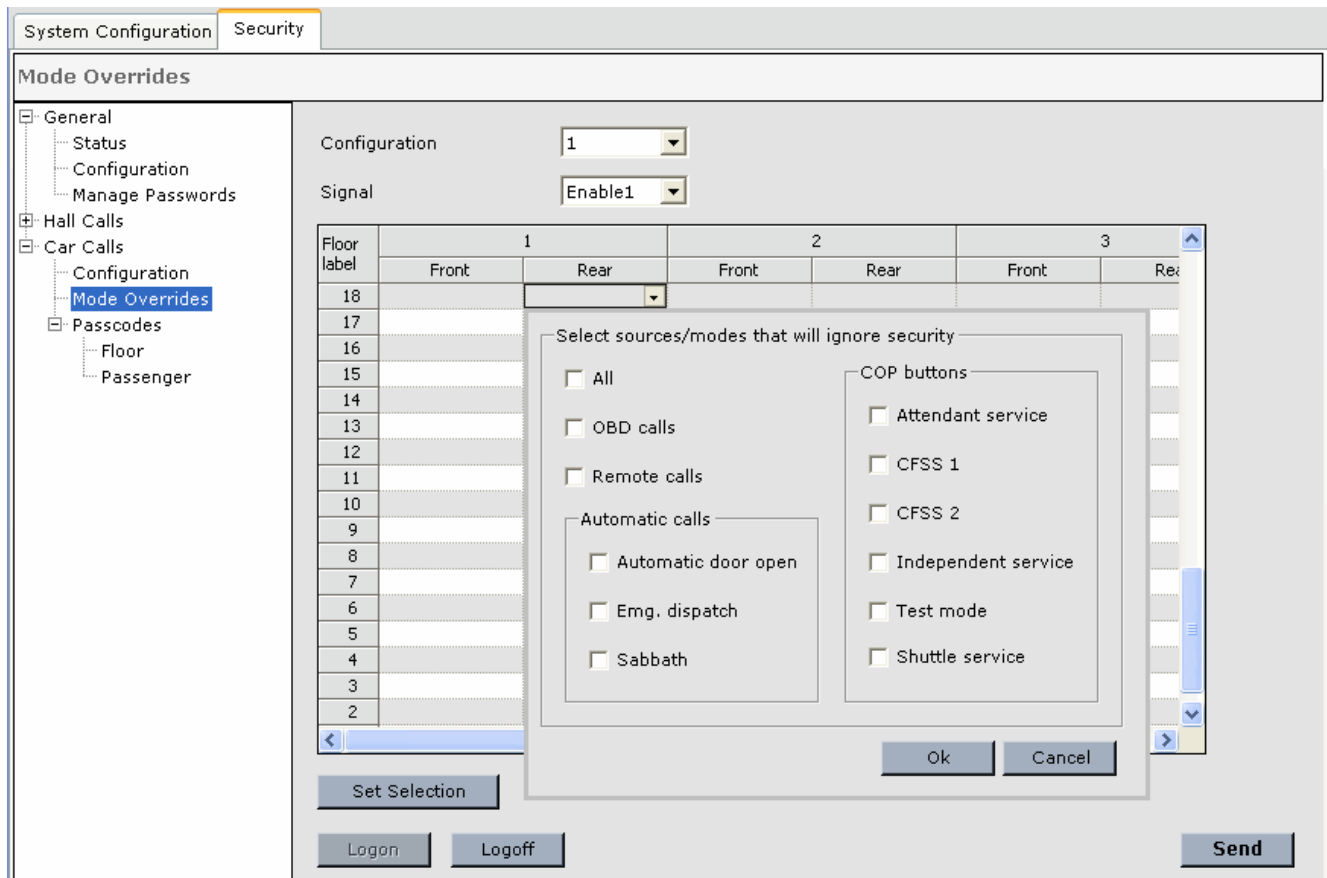
Other controls

- **Security input latch timer:** Car call enable inputs can be activated by a card reader, key switch, etc. Card readers typically hold the enable input activated for a period of time so that the user has time to enter the desired call. However, if a momentary switch or key switch is used to activate the hall call enable input, this control allows you to set the length of time, after the hall call enable input has been deactivated, that the user has to enter the call.

Car Calls - Mode Overrides

On a per configuration, per authorizing signal basis, you can allow a car call security restriction to be overridden when the car is operating in a selected mode or when the call is placed from a selected source. To program the override:

1. **Configuration:** Select the configuration affected by these choices.
2. **Signal:** Select the signal which would have been required to enable the restricted car call to be registered (Enable 1, Enable 2 or Passcode).



3. **Selection:** Select floors, and calls singly or in blocks as described previously ([Please refer to “Car Calls - Configuration” on page 10-45](#)).
4. Choose the sources /operating mode(s) that will override (ignore) the car call security restriction at the selected floor/riser.
 - **All:** Car calls from all of the following sources and modes.
 - **OBD calls:** Calls placed using the iBox On-board Display.
 - **Remote calls:** Calls placed using iView or iMonitor.
 - **Automatic calls:** Calls placed automatically by iControl, e.g.
 - **Automatic door open:** Under certain conditions, including certain fault conditions and emergency power transfer periods, the elevator doors may need to automatically open or cycle open/closed at floors. Activating this override, allows the doors to open or cycle even at a secured opening.
 - **Emergency dispatch:** Calls generated as a result of emergency dispatching.



- Sabbath: Calls generated as a result of the car being on Sabbath operation.
- COP buttons: Calls placed using COP buttons while the car is operating in one of the following modes: Attendant Service, CFSS 1, CFSS2, Independent service, Test mode, Shuttle service.

5. Click OK.

Active overrides are displayed as single letters, each corresponding to a mode:

- I = Independent • A=Attendant • 1=CFSS1 • 2=CFSS2 • D=Auto Door
- T=Test Mode • E=Emerg Dispatch • S=Sabbath • R=Remote • O=OBD

Car Calls - Passcodes

This screen allows you to set parameters that pertain to per-floor and passenger passcodes.

- **Timeout between buttons:** Passcodes are entered using car operating panel (COP) buttons. When the passenger is entering a passcode, if more than the number of seconds set here elapses between button presses, the passcode entry will time out.
- **Passenger passcode length:** Sets the length of the passenger passcodes. (It is recommended that the passenger passcode length and floor passcode length be the same).

Car Calls - Passcodes - Floor

This tab allows you to assign per-floor car call enable passcodes (passcodes are entered using COP buttons). To program a floor passcode

1. Select the Configuration (1 - 8).

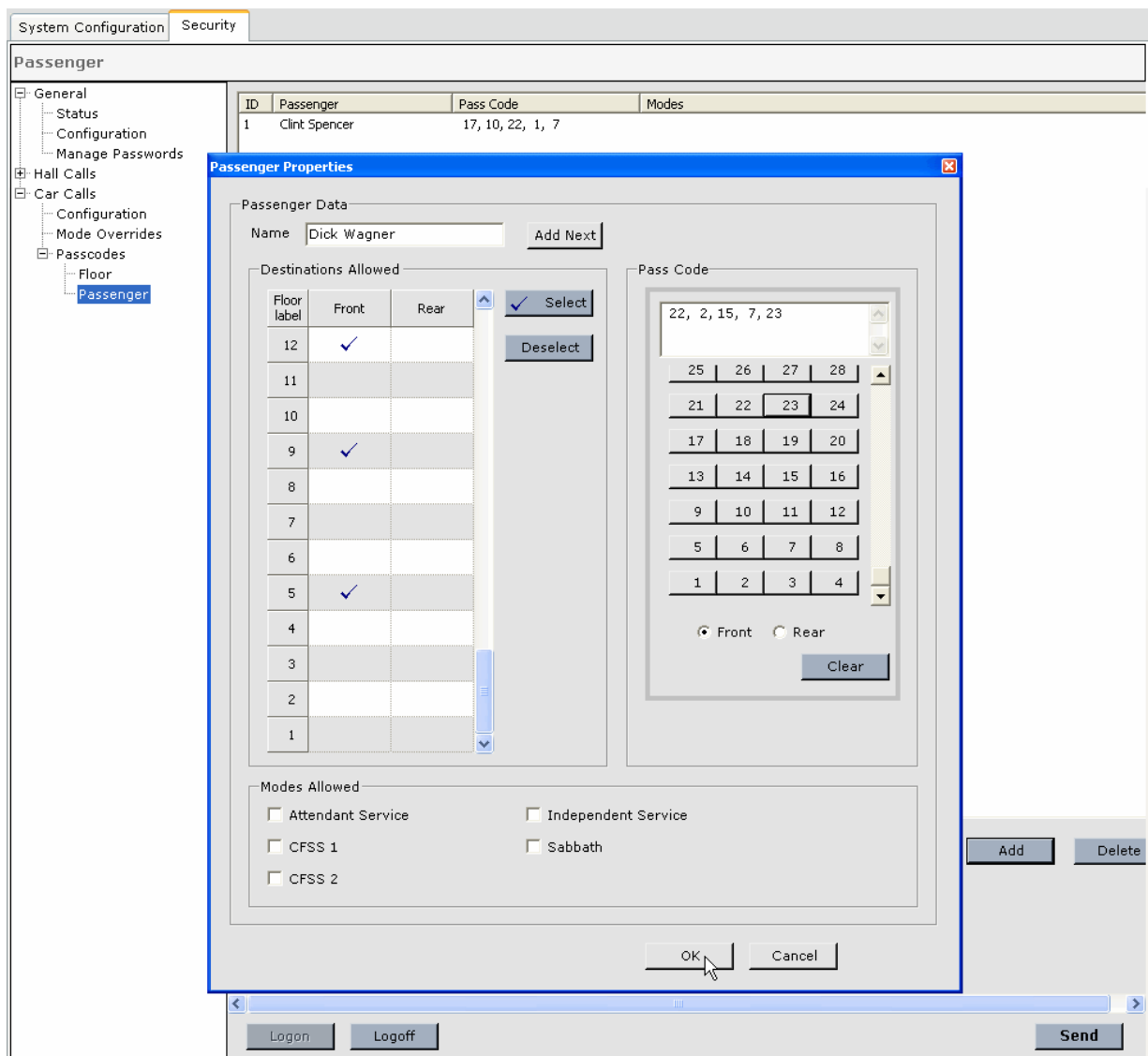
The screenshot shows the 'Security' tab in the 'System Configuration' window. The 'Floor' section is active, displaying a table for configuring passcodes for floors 1 through 18. The table has columns for 'Configuration' (set to 1), 'Front', and 'Rear' passcodes. A numeric keypad dialog is open, allowing the user to enter a passcode for the selected floor (18). The keypad has buttons for digits 1-9, 0, and function keys like 'Front', 'Rear', 'Clear', 'Ok', and 'Cancel'. The 'Front' radio button is selected in the dialog.

2. Select the floor(s) and call types as previously described (Please refer to “Car Calls - Configuration” on page 10-45).
3. In the dialog that appears, select the COP (front or rear) and the passcode (COP buttons that must be pressed).
4. Click *OK*.
5. If you make an entry error, click *Clear* and then re-enter the numbers.

Car Calls - Passcodes - Passenger

This tab allows you to assign per-passenger car call enable passcodes (passcodes are entered using COP buttons). To program a Passenger Passcode:

- Click the Add button. The Passenger Properties dialog is displayed.



- Enter the **Name**.
- Enter the **Destinations Allowed** by clicking the desired floors, front and/or rear, or click and drag to select multiple floors and then click Select or Deselect.

- Enter the **Pass Code** by clicking the desired call buttons and front or rear
- **Modes Allowed:** Authorizes the passenger to use the COP passcode while the car is operating on the selected mode(s) in addition to Passenger mode.

Security - COP Passcode operation For the elevator passenger, using the COP passcode to register call a call to a secured floor works as follows:

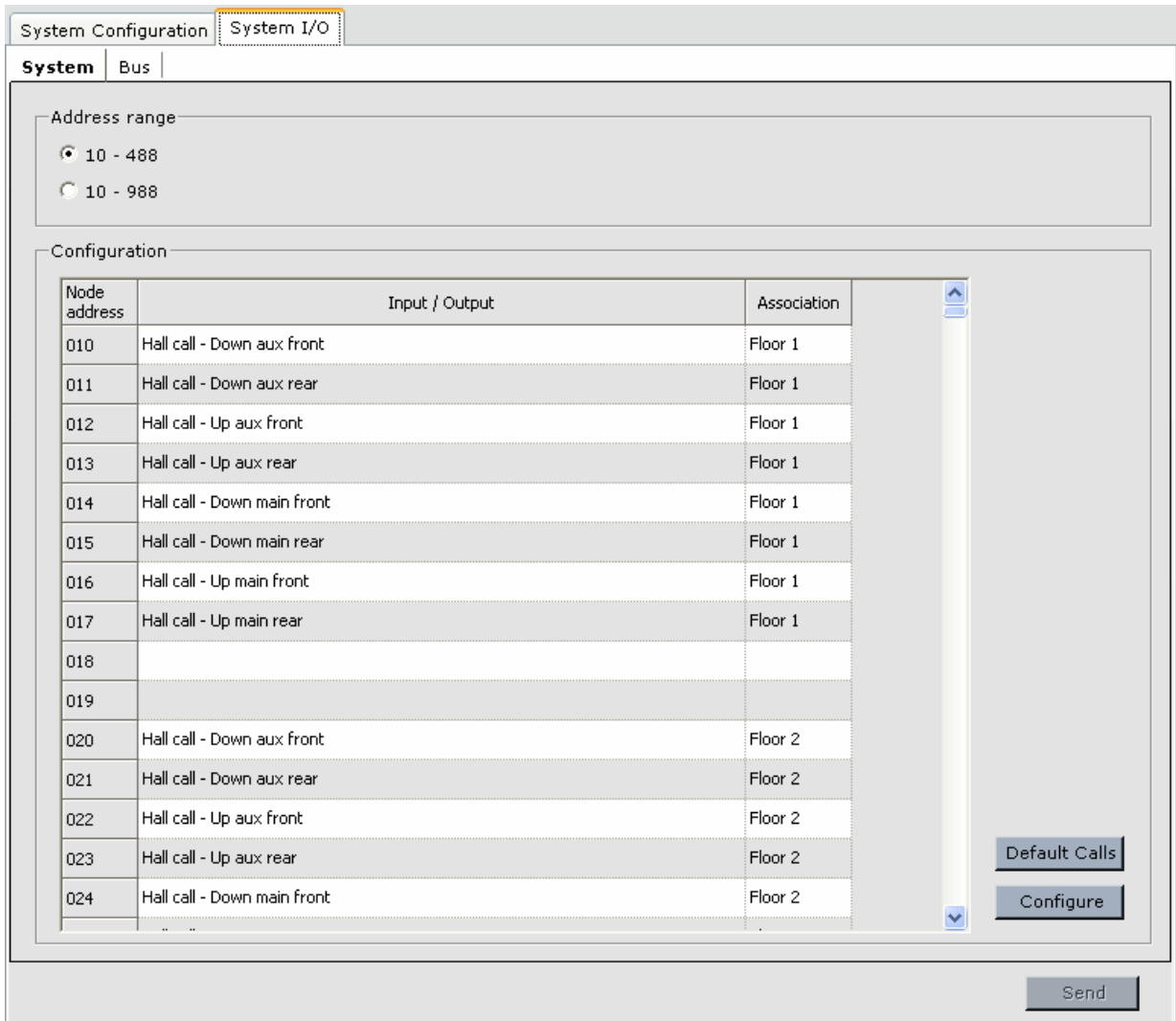
1. Press a floor selection on the COP as usual. The panel buttons will flash to indicate that a passcode must be entered.
2. Press floor buttons to enter the passcode.
3. Correct entry of the passcode will register the call. The panel buttons will return to normal.
 - An incorrect or timed-out entry will not register the call. The user may repeat the process if the entry was incorrect or timed out.

**Note**

If both a passcode entry and an enable input (card reader or switch) are required to register a particular call, the enable input must be completed before the COP passcode is entered.

Configuration Tabs - System I/O

System I/O allows iControl to use a simple, two-wire serial bus for external communication. For local cars (part of a group) the hall call assignments are made on the central dispatcher (iCentral) or Local/Dispatcher. For a simplex or swing car the hall call assignments are made using this tab on each car. Normally these assignments are made at the factory. You should only need to verify that the inputs and outputs are assigned correctly according to the job prints.



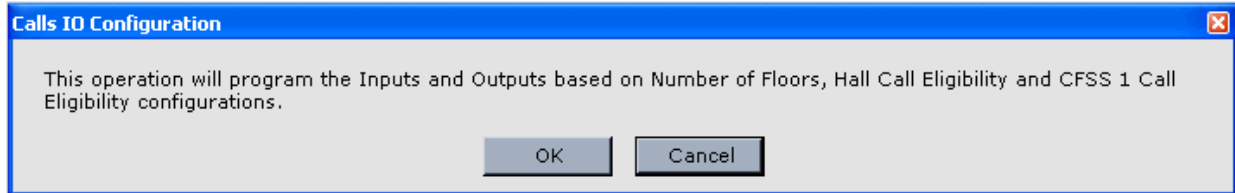
System Tab

This tab allows you to set the polling range for I/O addresses and to assign individual inputs and outputs to the desired functions.

Address Range Each serial bus will accommodate addresses from 10 to 488 or from 10 to 988. If your bus is not populated beyond 488 inputs and outputs, the smaller range should be used to speed up control response efficiency. The address range is preset at the factory according to the job survey. You should not need to change these settings if they are connected as shown in your job prints.

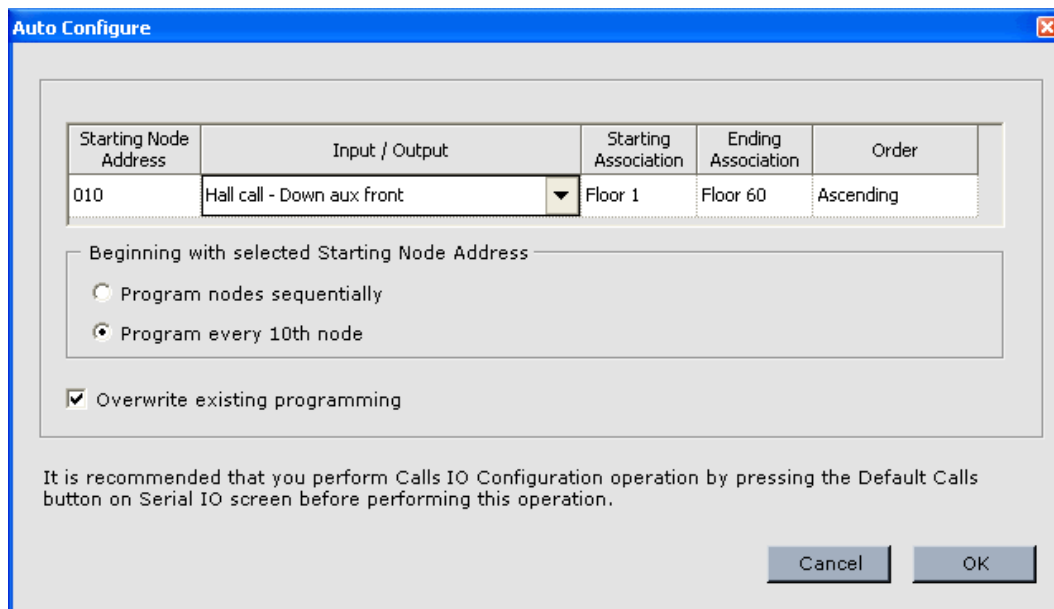
Default Calls Button

This selection defaults the address assignments to building condition settings (numbers of floors and cars, and call types). This is an excellent way to begin setting up I/O addressing if required. If selected, a warning is displayed:



Configure Button

This selection allows the system to automatically configure inputs and outputs of a type you select.



For example:

1. Click in the Starting Node Address column to select the address at which you want automatic assignment to begin.
2. Click in the Input/Output column to select an input or output group you would like to assign.
3. Set whether you want addresses assigned sequentially from the starting address you selected or whether you want the addresses assigned to every tenth location.
4. Set whether or not existing programming, if any, for the address range affected should be overwritten.
5. Click OK to automatically assign the selected input type to the addresses.

As noted in the Auto Configure dialog, we recommend you begin by clicking the Default calls button. You can then assign calls to addresses, and then run Auto Configure beginning with an unused input beyond the call assignments.

Configuring System I/O

This table allows you to define each input or output on the bus. **These settings are pre-defined at the factory according to the job survey and should not need to be changed if connected as shown on your job prints.**

- Node address: The addresses available on this bus.
- Input/Output: The type of input or output assigned to this address.

To assign an input or output to a node address:

1. Click in the *Input / Output* cell next to the desired node address.
2. Click the down arrow (right side of cell).
3. Double click an input or output from the list provided.
4. Click in the adjacent *Association* cell.
5. Click the desired selection.
6. Click Send to send the assignment to iControl.

The pre-defined inputs and outputs include:

- Hall Calls
 - Hall call - Down aux front: Select floor in Association column.
 - Hall call - Down aux rear: Select floor in Association column.
 - Hall call - Up aux front: Select floor in Association column.
 - Hall call - Up aux rear: Select floor in Association column.
 - Hall call - Down main front: Select floor in Association column.
 - Hall call - Down main rear: Select floor in Association column.
 - Hall call - Up main front: Select floor in Association column.
 - Hall call - Up main rear: Select floor in Association column.
- CFSS calls (Commandeer for Special Service)
 - CFSS call - Mode 1 front: Select floor in Association column.
 - CFSS call - Mode 1 rear: Select floor in Association column.
 - CFSS call - Mode 2 front: Select floor in Association column.
 - CFSS call - Mode 2 rear: Select floor in Association column.
- CFSS outputs (Commandeer For Special Service)
 - CFSS - Mode 1 in-use output: When all cars that are available to accept CFSS Mode 1 calls (determined by “Maximum number of cars to operate on CFSS Mode 1 at the same time” and each car’s eligibility map) have already been assigned to CFSS Mode 1 operation or are out-of-service, this output becomes active indicating that any additional CFSS Mode 1 calls must wait for a car to become available. Association column is blank.
 - CFSS - Mode 2 in-use output: When all cars that are available to accept CFSS Mode 2 calls (determined by “Maximum number of cars to operate on CFSS Mode 2 at the same time” and each car’s eligibility map) have already been assigned to CFSS Mode 2 operation or are out-of-service, this output becomes active indicating that any additional CFSS Mode 2 calls must wait for a car to become available. Association column is blank.

- CFSS - Mode 1 system output: This output becomes active when at least one car has been assigned to CFSS Mode 1 operation. Typically used to drive an indicator. Association column is blank.
- CFSS - Mode 2 system output: This output becomes active when at least one car has been assigned to CFSS Mode 2 operation. Typically used to drive an indicator. Association column is blank.
- Emergency Power inputs
 - EP - Emergency power input: iCue will accommodate one or two emergency power generators. An Emergency power input is used to inform iCue when emergency power is active (the Association column selected generator is active). Each elevator controller also has an Emergency power input connected to the generator from which it receives emergency power. Emergency power inputs may be active high or active low as configured when setting up emergency power parameters for iCue and individual elevator controllers. On the group Emergency Power screen, elevators are designated as powered by generator 1 or 2 so that iCue knows which Emergency power input to associate with the car. Select generator in Association column.
 - EP - Auto recall selection switch input: Emergency Power operation proceeds in two phases: Recall - cars are sequentially recalled to their recall floor. Run - cars are allowed to run, typically one car per building vertical transportation sector (group) at a time to ensure adequate power is available. When activated, the Auto recall selection switch input causes iCue to sequentially recall cars to their return floor. If a car is already actively selected to run on emergency power (see EP - Emergency power automatic run input below), the recall phase is bypassed. Select generator ID in Association column.
 - EP - Emergency power automatic run input: When active, this input causes iCue to automatically select cars to run after considering the status of the EP - Emergency power run input (see below). Select generator ID in Association column.
 - EP -Power transfer input: When active, notifies iCue that commercial power has been restored and transfer from emergency to commercial power is pending. A maximum of two Power transfer inputs, one for each emergency generator accommodated, can be configured. Which generator is associated with the input is determined by the (Generator 1 or Generator 2) selection in the Associations column of this table. Activation of this input causes iCue to command all cars not already in Freeze Status to stop at the next available landing and enter Freeze Status. This input must be activated in advance of the transfer from generator to commercial power to allow all cars to safely make a normal stop. When commercial power is restored, iCue will return cars to normal operation. Select generator ID in Association column.
 - EP -Emergency power run input: When active, designates the specified car to have power during the run phase. Select Car ID in the Association column. This per car input overrides the recall phase.
- Emergency Power Outputs
 - EP - Emergency power service output: Activates when the system is not on emergency power. Select generator ID in Association column.
 - EP - Emergency power phase I output: Active during Freeze or Recall phase of emergency power operation. Select generator ID in Association column.
 - EP - Emergency power phase II output: Active during Run phase of emergency power operation. Select generator ID in Association column.

- EP - Car selected for emergency power output: Active when the car is given power during emergency power operation. Essentially this is the combination of outputs EP - Car selected to run and EP - Car selected to recall. If the car is given power to operate at any time during emergency power operation, the output will be activated. Select the Car ID in the Association column.
- EP - Car selected to recall output: Active when the car is given power to Recall during Emergency Power operation. Select the Car ID in the Association column.
- EP - Car selected to run output: Becomes active when the specified car is selected to operate. The output is always cleared during Freeze and Recall phases and during Power transfer activation upon stopping at a floor. Select Car ID in Association column.

Cross Registration: Cross registration is intended for use during modernization projects. It provides an interface between cars in a newly installed iControl group and cars in an existing (legacy) group. The iCue dispatcher will preferentially assign hall calls to iControl cars unless the estimated time of arrival for an iControl car exceeds a limit programmed by the user (Cross Registration screen). In this case, iCue will assign the call to the legacy group dispatcher. Hall Call Eligibility for legacy cars must be programmed into iCue, just as they are in the legacy group, to ensure that only cars that are eligible are dispatched to answer calls.

- Cross registration inputs: The following inputs are used for cross-registration of hall calls.
 - Cross reg - Down aux front input: Select floor in Association column.
 - Cross reg - Down aux rear input: Select floor in Association column.
 - Cross reg - Up aux front input: Select floor in Association column.
 - Cross reg - Up aux rear input: Select floor in Association column.
 - Cross reg - Down main front input: Select floor in Association column.
 - Cross reg - Down main rear input: Select floor in Association column.
 - Cross reg - Up main front input: Select floor in Association column.
 - Cross reg - Up main rear input: Select floor in Association column.
 - Cross reg - Car in-service input. Select Car ID in Association column.
- Cross registration outputs: Used for cross-registration of hall calls.
 - Cross reg - Down aux front output: Select floor in Association column.
 - Cross reg - Down aux rear output: Select floor in Association column.
 - Cross reg - Up aux front output: Select floor in Association column.
 - Cross reg - Up aux rear output: Select floor in Association column.
 - Cross reg - Down main front output: Select floor in Association column.
 - Cross reg - Down main rear output: Select floor in Association column.
 - Cross reg - Up main front output: Select floor in Association column.
 - Cross reg - Up main rear output: Select floor in Association column.



Note

For all the above, the floor selected in the Association column defines the call location for the iCue software.

- Cross reg - Emergency dispatch output: (Notifies legacy group that we are unable to cross-register hall calls because of a serial IO failure or iCue shutdown and that it should put its cars on emergency dispatch operation.) Association column is blank.

- General outputs
 - General - Attendant service output: Active when the specified car is on Attendant Service operation. Select Car ID in Association column.
 - General - Fire service phase I output: Active during Fire Recall Phase I. Association column is blank.
- Manual configuration inputs
 - Manual config - Hall call configuration input: Selects the Hall call eligibility configuration (1 - 8) designated in the Association column to be the currently active configuration.
 - Manual config - Parking configuration input: Selects the Parking configuration (1 - 8) designated in the Association column to be the currently active configuration.
 - Manual config - Parking eligibility configuration input: Selects the Parking eligibility configuration (1 - 8) designated in the Association column to be the currently active configuration.
 - Manual config - Mode of operation configuration input: Selects the Mode of operation configuration (1 - 8) designated in the Association column to be the currently active configuration.
 - Manual config - Security configuration input: Selects the Security configuration (1 - 8) designated in the Association column to be the currently active configuration.
- Active configuration outputs
 - Active config - Hall call eligibility output: Indicates that the Hall call eligibility configuration (1 - 8) designated in the Association column is the currently active configuration.
 - Active config - Parking output: Indicates that the Parking configuration (1 - 8) designated in the Association column is the currently active configuration.
 - Active config - Parking eligibility output: Indicates that the Parking eligibility configuration (1 - 8) designated in the Association column is the currently active configuration.
 - Active config - Mode of operation output: Indicates that the Mode of operation configuration (1 - 8) designated in the Association column is the currently active configuration.
 - Active config - Security output: Indicates that the Security configuration (1 - 8) designated in the Association column is the currently active configuration.

Security: The following inputs control how hall calls to secured floors are handled by the system. They are typically activated from switches or buttons at the building security station so that security personnel can easily and quickly make adjustments to hall call security as a situation demands. They can also be activated by a card reader or keypad, etc.

- Hall call enable 1 (or 2) inputs
 - Hall call enable 1 (2) - Floor input: When active, a valid call for the secured floor can be registered. Select floor number in Association column.
 - Hall call enable 1 (2) - Front input: When active, a valid call for the front opening on the associated secured floor can be registered. Select floor number in Association column.

- Hall call enable 1 (2) - Rear input: When active, a valid call for the rear opening on the associated floor can be registered. Select floor number in Association column.
- Hall call enable 1 (2) - Main front input: When active, valid secured calls at the associated floor, main front riser, can be registered. Select floor number in Association column.
- Hall call enable 1 (2) - Main rear input: When active, a valid call at the associated secured floor, main rear riser, can be registered. Select floor number in Association column.
- Hall call enable 1 (2) - Aux front input: When active, a valid call at the associated secured floor, auxiliary front riser, can be registered. Select floor number in Association column.
- Hall call enable 1 (2) - Aux rear input: When active, a valid call at the associated secured floor, auxiliary rear riser, can be registered. Select floor number in Association column.
- Hall call enable 1 (2) - Down aux front input: When active, a valid call at the associated secured floor, down auxiliary front riser, can be registered. Select floor number in Association column.
- Hall call enable 1 (2) - Down aux rear input: When active, a valid call at the associated secured floor, down auxiliary rear riser, can be registered. Select floor number in Association column.
- Hall call enable 1 (2) - Up aux front input: When active, a valid call at the associated secured floor, up auxiliary front riser, can be registered. Select floor number in Association column.
- Hall call enable 1 (2) - Up aux rear input: When active, a valid call at the associated secured floor, up auxiliary rear riser, can be registered. Select floor number in Association column.
- Hall call enable 1 (2) - Down main front input: When active, a valid call at the associated secured floor, down main front riser, can be registered. Select floor number in Association column.
- Hall call enable 1 (2) - Down main rear input: When active, a valid call at the associated secured floor, down main rear riser, can be registered. Select floor number in Association column.
- Hall call enable 1 (2) - Up main front input: When active, a valid call at the associated secured floor, up main front riser, can be registered. Select floor number in Association column.
- Hall call enable 1 (2) - Up main rear input: When active, a valid call at the associated secured floor, up main rear riser, can be registered. Select floor number in Association column.

NOTE: The inputs above are OR'ed together with the greater permission exerting control.

- CFSS call enable 1 (or 2) inputs
 - CFSS call enable 1 (2) - CFSS mode 1 input: When active, a valid CFSS mode 1 call at the associated secured floor, can be registered. Select the floor number in the Association column. (CFSS mode 1 and 2 are user-assignable operating modes typically used for medical emergency calls, attendant calls, etc.)

- CFSS call enable 1 (2) - CFSS mode 1 front input: When active, a valid CFSS mode 1 call at the associated secured floor, front opening only, can be registered. Select the floor number in the Association column. (CFSS mode 1 and 2 are user-assignable operating modes typically used for medical emergency calls, attendant calls, etc.)
- CFSS call enable 1 (2) - CFSS mode 1 rear input: When active, a valid CFSS mode 1 call at the associated secured floor, rear opening only, can be registered. Select the floor number in the Association column. (CFSS mode 1 and 2 are user-assignable operating modes typically used for medical emergency calls, attendant calls, etc.)
- CFSS call enable 1 (2) - CFSS mode 2 input: When active, a valid CFSS mode 2 call at the associated secured floor, can be registered. Select the floor number in the Association column. (CFSS mode 1 and 2 are user-assignable operating modes typically used for medical emergency calls, attendant calls, etc.)
- CFSS call enable 1 (2) - CFSS mode 2 front input: When active, a valid CFSS mode 2 call at the associated secured floor, front opening only, can be registered. Select the floor number in the Association column. (CFSS mode 1 and 2 are user-assignable operating modes typically used for medical emergency calls, attendant calls, etc.)
- CFSS call enable 1 (2) - CFSS mode 2 rear input: When active, a valid CFSS mode 2 call at the associated secured floor, rear opening only, can be registered. Select the floor number in the Association column. (CFSS mode 1 and 2 are user-assignable operating modes typically used for medical emergency calls, attendant calls, etc.)
- Security Override
 - Security override - Master security override input: When active, all secured calls are enabled. All secured car and hall calls will behave as though unsecured. Locked calls will remain locked.
 - Security override - Hall call enable 1 override input: When active, all Enable 1 secured hall calls are unsecured. Locked calls will remain locked.
 - Security override - Hall call enable 2 override input: When active, all Enable 2 secured hall calls are unsecured. Locked calls will remain locked.
- Split bank hall calls: When enabled and active, split bank operation allows a single control group of cars to be controlled as though it were two separate groups. These inputs provide connection points for the auxiliary and main riser hall call buttons for the cars split from the group (Bank B).
 - Bank B hall call - Down aux front
 - Bank B hall call - Down aux rear
 - Bank B hall call - Up aux front
 - Bank B hall call - Up aux rear
 - Bank B hall call - Down main front
 - Bank B hall call - Down main rear
 - Bank B hall call - Up main front
 - Bank B hall call - Up main rear

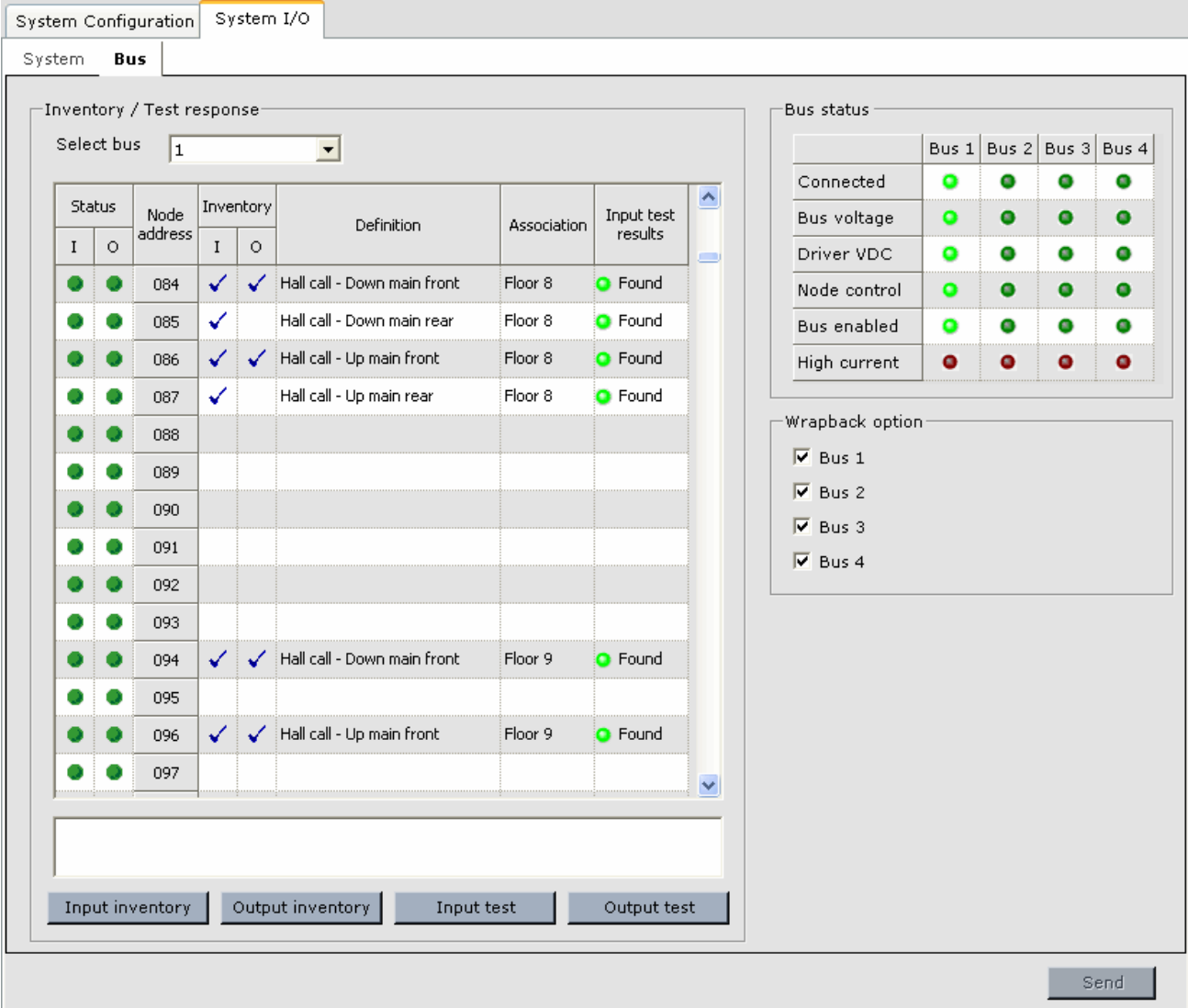
- **Remote User Outputs:** Up to 32 outputs may be defined by the user on the Remote Outputs tab. The first four of these outputs may be included in timer tables and triggered by the timer. Outputs may also be manually triggered from the Remote Outputs > Trigger tab. Once defined, the outputs are associated with a physical output address using the System I/O or I/O Boards tab. Outputs may be latching or toggle, active high or low, and are intended to be used to drive system inputs as required by individual sites.
 - Remote (01 - 32)
- **User Defined Events:** Up to 10 inputs may be used to trigger a specific event message to be posted to the system event log. The user defines the text of the event on the User Events tab, then assigns a physical address (location) to the input using the System I/O tab.
 - User Event 1 (- 10)
- **Active Mode of Operation Outputs:**
 - **Balanced:** Active when the system is operating in balanced mode, typically to drive a visual indicator.
 - **Lobby Peak:** Active when the system is operating in lobby peak mode, typically to drive a visual indicator.
 - **Demand Up Peak:** Active when the system is operating in demand up peak mode, typically to drive a visual indicator.
 - **Demand Down Peak:** Active when the system is operating in demand down peak mode, typically to drive a visual indicator.
- **Association Column:**
 Choices selectable in this column are dependent on the adjoining Input/Output selection as follows:
 - For hall calls, the floor Association selection is presented.
 - For emergency power related functions, generator assignment is presented (Gen1 or Gen2).
 - For recall/car related functions, the car Association selection is presented.



Remember, the above settings are all pre-configured before the controller is shipped from MCE. You should need only to connect inputs and outputs according to your job prints. These settings should not be changed or edited unless hardware affecting these settings is being replaced. In these instances, follow specific instructions provided by MCE.

System I/O - Bus Tab

The Bus tab allows you to see the status of the system busses (1 - 4), create an inventory of devices on the busses and to test device functionality in comparison to the inventory.



System Configuration System I/O

System **Bus**

Inventory / Test response

Select bus 1

Status		Node address	Inventory		Definition	Association	Input test results
I	O		I	O			
●	●	084	✓	✓	Hall call - Down main front	Floor 8	● Found
●	●	085	✓		Hall call - Down main rear	Floor 8	● Found
●	●	086	✓	✓	Hall call - Up main front	Floor 8	● Found
●	●	087	✓		Hall call - Up main rear	Floor 8	● Found
●	●	088					
●	●	089					
●	●	090					
●	●	091					
●	●	092					
●	●	093					
●	●	094	✓	✓	Hall call - Down main front	Floor 9	● Found
●	●	095					
●	●	096	✓	✓	Hall call - Up main front	Floor 9	● Found
●	●	097					

Bus status

	Bus 1	Bus 2	Bus 3	Bus 4
Connected	●	●	●	●
Bus voltage	●	●	●	●
Driver VDC	●	●	●	●
Node control	●	●	●	●
Bus enabled	●	●	●	●
High current	●	●	●	●

Wrapback option

Bus 1

Bus 2

Bus 3

Bus 4

Input inventory Output inventory Input test Output test

Send

Bus Status LEDs light to indicate the status of each bus.

- **Connected:** Lights green when the selected bus is properly connected.
- **Bus Voltage:** Lights green when serial bus voltage is within normal limits.
- **Driver VDC:** Lights green when Serial Hall Call Driver (J2) voltage is within normal limits.
- **Node Control:** Lights green when nodes respond correctly.
- **Bus Enabled:** Lights green when the selected bus is enabled.
- **High Current:** Lights red when bus current demand is excessive.

Wrapback Option When enabled, hall call lamps are lighted immediately when the associated hall call button is pressed (rather than waiting for a response from the group controller to light the lamp).


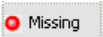

Inventory / Test response These controls allow you to create an inventory of input and output devices on the system busses (1 - 4) and to test the functionality of the devices against the inventory.

- **Select Bus:** Select the bus to be inventoried or tested.
- **Status (I/O):** The LEDs indicate the current status, On or OFF, of the input and/or output at each node address.
- **Inventory (I/O):** The table displays the results of the last run Input and Output inventory. Typically, you run an inventory after all system bus devices are connected so that the controller learns the connected devices.

Note: You must have write privilege to take an Input or Output inventory or perform an Input or Output test. To acquire write privilege:

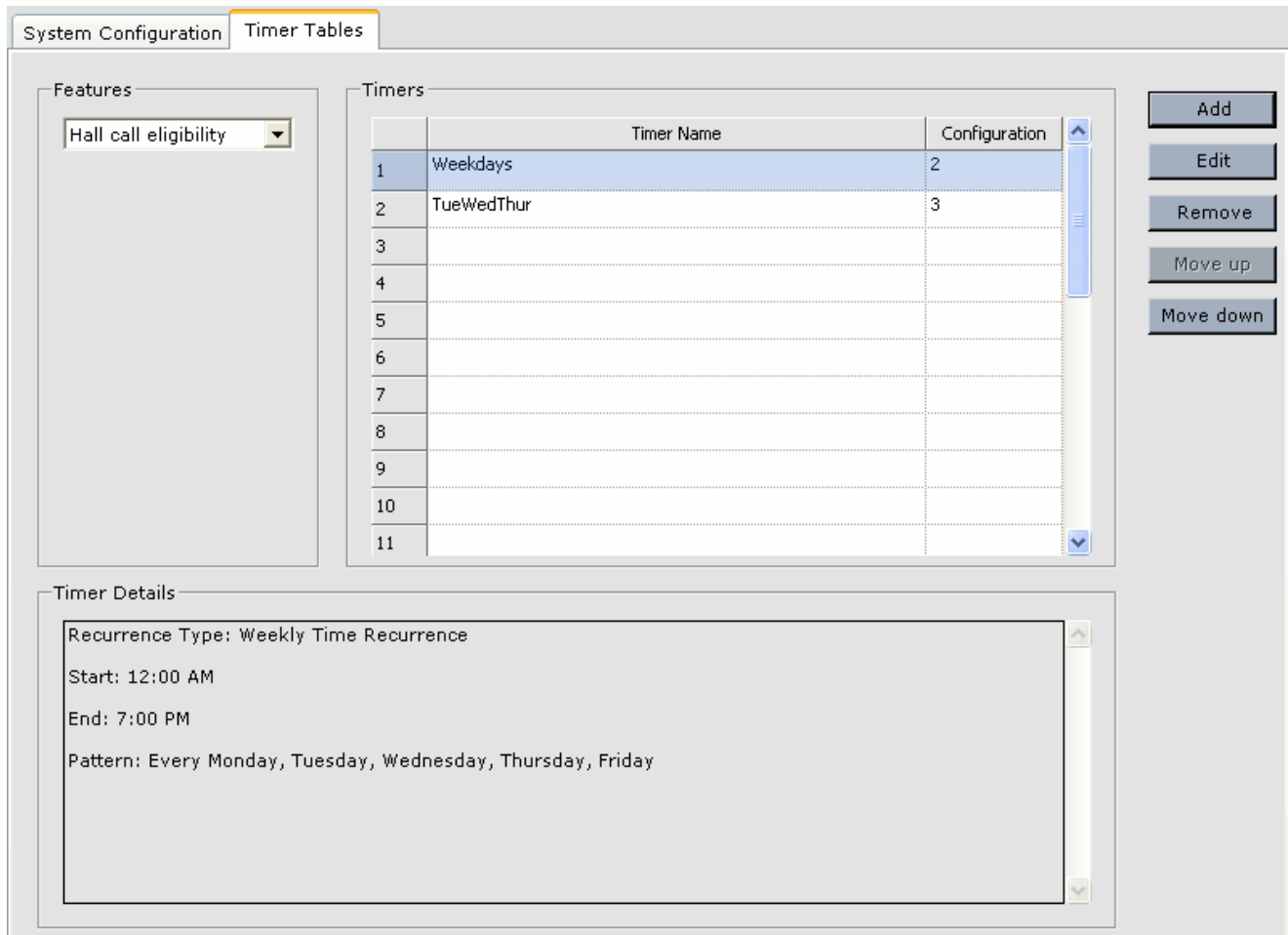
1. Select *Acquire* from the iView Write privilege menu.
2. Press the iBox *Yes* soft key in response to the request for write privilege.
 - **Input inventory:** To run an input inventory, click the *Input inventory* button when you are certain all devices are properly connected on the system bus. A check mark will appear in the Input inventory column for every address location at which the controller sees a functioning device. Compare this against your physical inventory to make certain that all devices responded properly.
 - **Output inventory:** To run an output inventory, click the *Output inventory* button. A check mark will appear in the Output inventory column for every address location at which the controller sees a functioning device. Note that at this time, outputs using an SC-ION board will not be recognized by this software inventory or test and must be observed physically on the board.

When you run an input or output test, the controller compares the responses against the known quantity of the inventory.

- **Input test:** The Input test sequentially sends a test message to and reads a response from all input devices on the bus. Click the *Input test* button to initiate the test.
- **Output test:** The Output test sequentially checks the continuity of the circuit powering each node lamp, buzzer, or other indicator. Click the *Output test* button to initiate the test.
- **Test results:** The results of the Input or Output test are displayed in the right hand column of the table. The column label changes depending on the test, e.g. Input test results or Output test results. The possible results include:
 - **Found**  **Found** : A green LED indicates that the test results match the inventory at this node address.
 - **Missing**  **Missing** : A red LED indicates that the test did not find a working device that was previously found at this node address by the inventory. This could indicate a device failure.
 - **New**  **New** : A yellow LED indicates that a device was found at this node address during the test that is not indicated in the inventory. This could indicate a newly installed device or a device programming error.

Configuration Tabs - Timer Tables (System)

This tab allows you to create timers that automatically determine, based on day and time of day, the currently active configuration for Hall Call Eligibility, Parking, Parking Eligibility, Mode of Operation and Security. In addition, timer tables can be used to control the first four Remote outputs.



The screenshot displays the 'Timer Tables' configuration window. It is divided into three main sections: Features, Timers, and Timer Details.

Features: A dropdown menu is set to 'Hall call eligibility'.

Timers: A table with 11 rows and 3 columns: Index, Timer Name, and Configuration.

	Timer Name	Configuration
1	Weekdays	2
2	TueWedThur	3
3		
4		
5		
6		
7		
8		
9		
10		
11		

Timer Details: A text area showing the following information:

- Recurrence Type: Weekly Time Recurrence
- Start: 12:00 AM
- End: 7:00 PM
- Pattern: Every Monday, Tuesday, Wednesday, Thursday, Friday

On the right side of the interface, there are five buttons: Add, Edit, Remove, Move up, and Move down.

Features

The timers associated with the type of configuration or operation selected in Features are displayed in the Timers list. For example, in the screen above, Hall Call Eligibility is selected and the timers that automatically determine the currently active Hall Call Eligibility Configuration are displayed. (The configurations that the timer tables select are created through the System Configuration and Security tabs). Timers may be displayed for:

- Hall Call Eligibility
- Parking
- Parking Eligibility
- Mode of Operation
- Security
- Remote 01 - 04

Timer Details

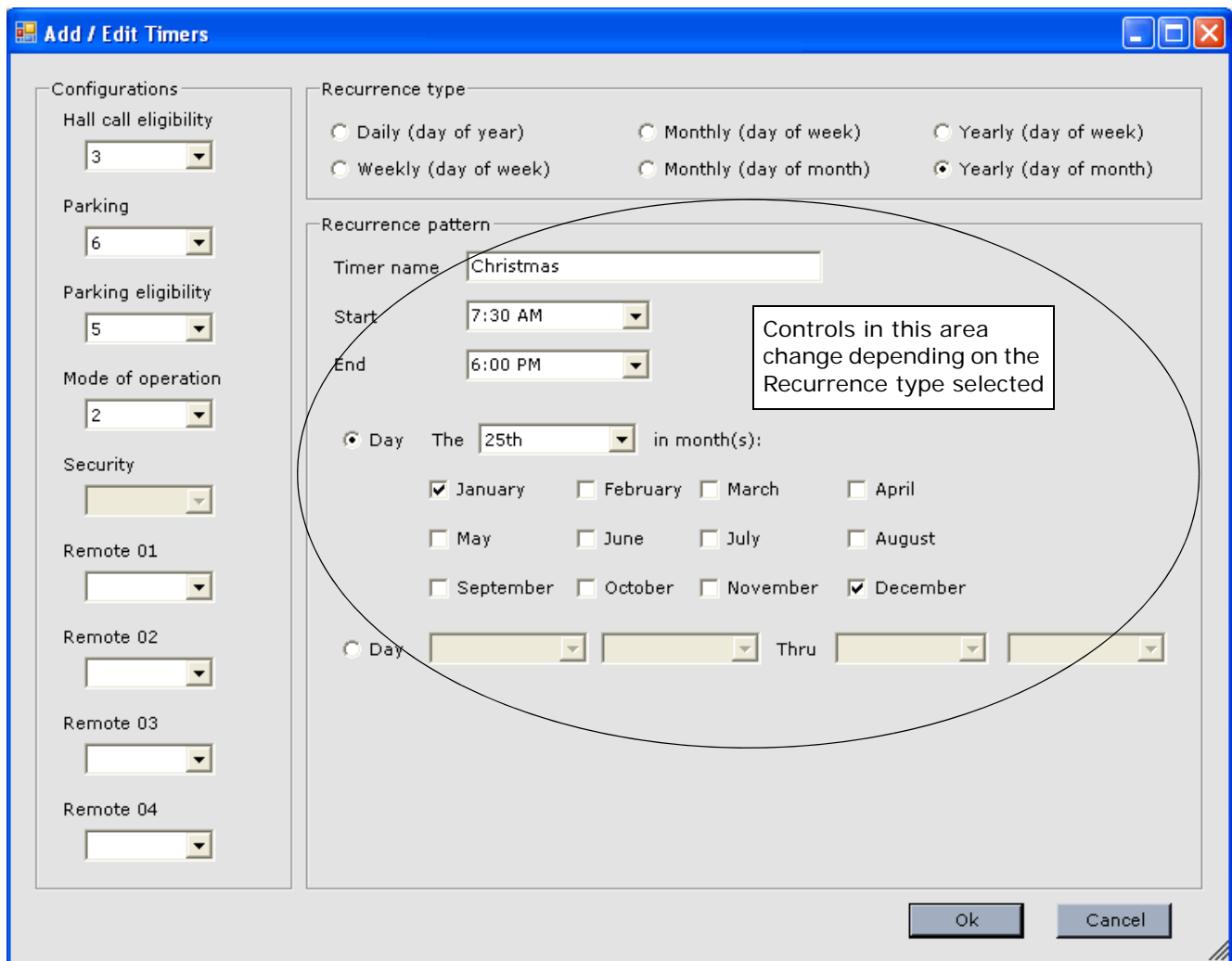
When a timer is selected in the table, details of its settings appear in Timer Details. (You must select a timer and click Edit to change settings, this display is read only.)

Timers

Timers are displayed in the Timers list. If timers overlap (manage the same period of time), the timer appearing higher in the list will have priority (control). To move a timer within the list, click to select it, then click Move Up or Move Down.

Add a Timer To add a new timer to the list:

1. Click Add. The Add/Edit Timer dialog is displayed.



2. From the Configurations list, select the configuration(s) and/or feature(s) that should be active when this timer is valid (timer day and time are the present day and time).
3. Select the repeat frequency (Recurrence type) of the timer:
 - Daily: This timer is active every day during the specified time period.

- Weekly (Day of the week): This timer is active each week on the specified day or days (i.e., Mondays or Mondays and Tuesdays) or can be set to span days (i.e., Monday through Wednesday).
 - Monthly (Day of week): This timer is active each month on the specified week days (i.e., first Monday, third Sunday, etc.) or can be set to span days (i.e., second Sunday through third Saturday, etc.).
 - Monthly (Day of month): This timer is active each month during the specified time period, on the specified date or dates or may be set to span dates.
 - Yearly (Day of week): This timer is active each year during the specified time period, during the specified month or months, on the specified day or days or may be set to span days across multiple months.
 - Yearly (Day of month): This timer is active each year during the specified time period, during the specified month or months, on the specified date or dates or may be set to span dates across multiple months.
4. Enter the timer details using the Recurrence pattern controls. (These controls change depending on the Recurrence type selected.)
 - Enter a descriptive name for the timer (up to 25 characters).
 - Select the start and end time, day(s) or date information required.
 5. Click OK.
 6. Click Send to send new or changed timer information to iControl.

To remove a timer

1. Select a configuration/feature type from the Features drop down list.
2. Select a timer from the Timers list.
3. Click Remove.

To edit a timer

1. Select a configuration/feature type from the Features drop down list.
2. Select a timer from the Timers list.
3. Click Edit.
4. Make changes using the Add/Edit Timers dialog.
5. Click OK.

To move a timer A timer's position in the list determines its priority. If two timers are attempting to control the same configuration at the same time, the timer higher in the list (lower Priority number) will have control. To move a timer:

1. Select the timer from the Timers list.
2. Click Move Up or Move Down.



Note

No valid timer: For a particular configuration/feature, i.e., Parking, Mode of Operation, Auto Stop, etc., if Timed is selected and there is no valid timer (current date and time falls within the timer's date(s) and times), those configurations/features will default to their #1 configuration or default state.

Configuration Tabs - User Events

The User Events tab is used to assign a name to an *Input / User Event*. Up to 10 Input / Event Names can be programmed. This event name can then be assigned to a hardware input. An event is logged, on the System Event Log, when the input is activated and again when it is deactivated. System - Input / Event Names are assigned to terminals on an SC-ION Serial Input/Output Board using the System > Configuration > System I/O tab. For information about Controller User Events see “[Configuration - Advanced - User Events](#)” on page 9-138.

The screenshot shows a software interface for configuring user events. At the top, there are two tabs: "System Configuration" and "User Events", with "User Events" being the active tab. Below the tabs is a large rectangular area titled "User Defined Events For System Event Log". Inside this area is a table with two columns: "User Defined Events" and "Input / Event Name". The table contains 10 rows, each representing an event from Event 1 to Event 10. Each row has a text input field containing the name "User Event 1" through "User Event 10" respectively. At the bottom right of the main configuration area, there is a "Send" button.

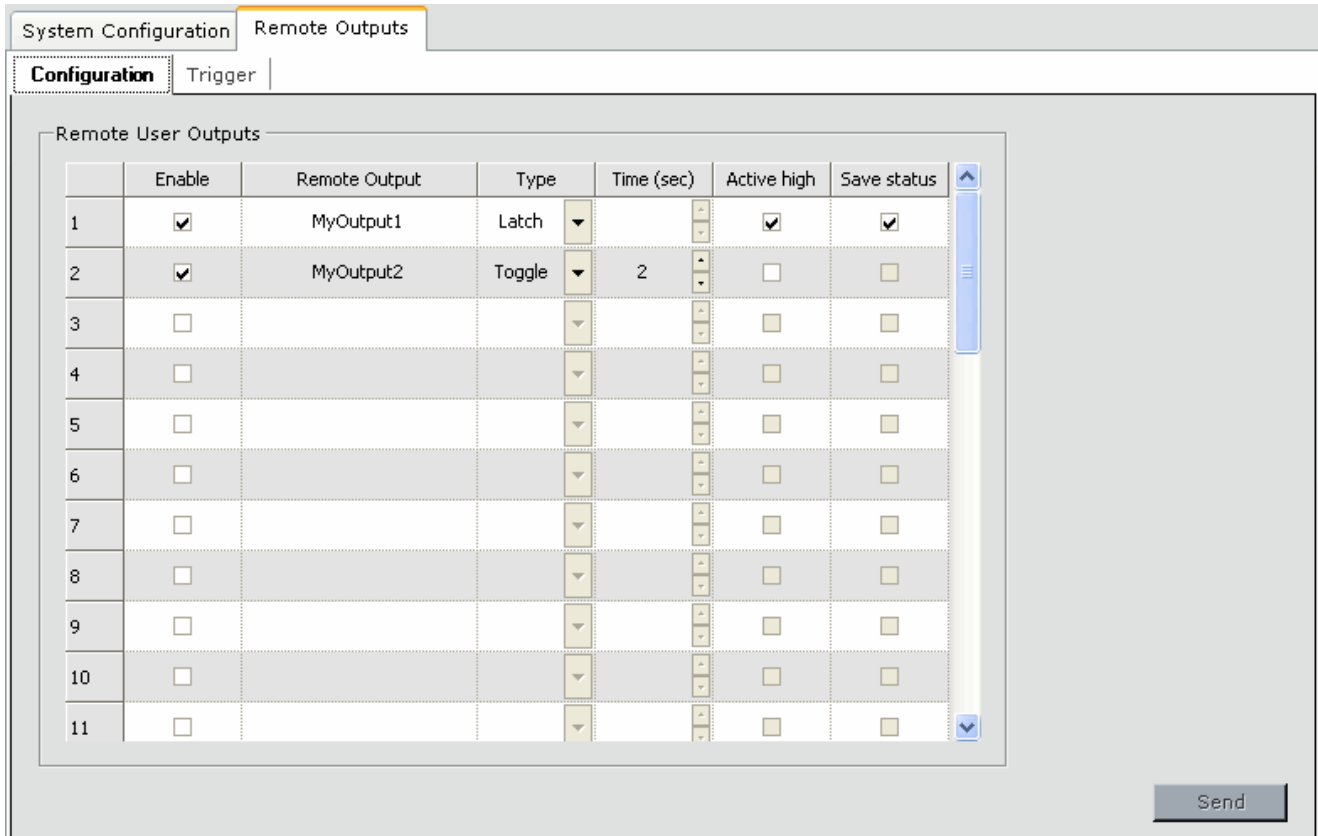
User Defined Events	Input / Event Name
Event 1	User Event 1
Event 2	User Event 2
Event 3	User Event 3
Event 4	User Event 4
Event 5	User Event 5
Event 6	User Event 6
Event 7	User Event 7
Event 8	User Event 8
Event 9	User Event 9
Event 10	User Event 10

To configure a System User Event:

1. Display the User Events tab (System > Configuration > User Events tab).
2. Enter the desired *Input / Event Name*, up to 40 characters.
3. *Send* the Input / Event name to the controller. The name will then appear under *User-Defined Events* on the list of inputs used to configure the I/O Boards.
4. Assign the event to a terminal on an SC-ION Serial Input/Output Board using the System > Configuration > System I/O tab. Please refer to “[Configuration Tabs - System I/O](#)” on page 10-51.

Configuration Tabs - Remote Outputs

The Remote Outputs tab allows the user to name and configure up to 32 hardware outputs which can be wired to any input or other device as needed. The outputs are turned on and off manually by clicking a graphical switch through iView and/or iMonitor or automatically via a timer. The type of output, latching or toggled, as well as the polarity of the output, active high or active low, are user selectable. And the status of latched outputs may be saved so that they remain in the same state after power is cycled.



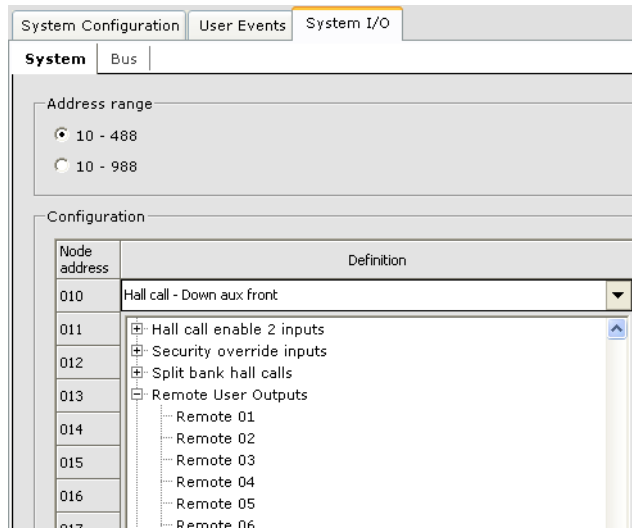
	Enable	Remote Output	Type	Time (sec)	Active high	Save status
1	<input checked="" type="checkbox"/>	MyOutput1	Latch		<input checked="" type="checkbox"/>	<input checked="" type="checkbox"/>
2	<input checked="" type="checkbox"/>	MyOutput2	Toggle	2	<input type="checkbox"/>	<input type="checkbox"/>
3	<input type="checkbox"/>				<input type="checkbox"/>	<input type="checkbox"/>
4	<input type="checkbox"/>				<input type="checkbox"/>	<input type="checkbox"/>
5	<input type="checkbox"/>				<input type="checkbox"/>	<input type="checkbox"/>
6	<input type="checkbox"/>				<input type="checkbox"/>	<input type="checkbox"/>
7	<input type="checkbox"/>				<input type="checkbox"/>	<input type="checkbox"/>
8	<input type="checkbox"/>				<input type="checkbox"/>	<input type="checkbox"/>
9	<input type="checkbox"/>				<input type="checkbox"/>	<input type="checkbox"/>
10	<input type="checkbox"/>				<input type="checkbox"/>	<input type="checkbox"/>
11	<input type="checkbox"/>				<input type="checkbox"/>	<input type="checkbox"/>

To configure a Remote Output:

1. Display the Remote Outputs > Configuration tab.
2. Click the *Enable* check box for the output you wish to configure.
3. Click in the *Remote Output* name cell and type the desired name, up to 9 characters.
4. Select the *Type* of output, Latch or Toggle.
5. For Toggle outputs, set the *Time* (amount of time that the output will remain ON).
6. Click the *Active high* check box to set the output's polarity to active high. Leave it unchecked to set the polarity to active low.
7. If you want the status of a latched output to be saved when power is cycled, click the *Save status* check box.
8. *Send* the changes to the controller.

Assigning Remote Outputs to an output terminal:

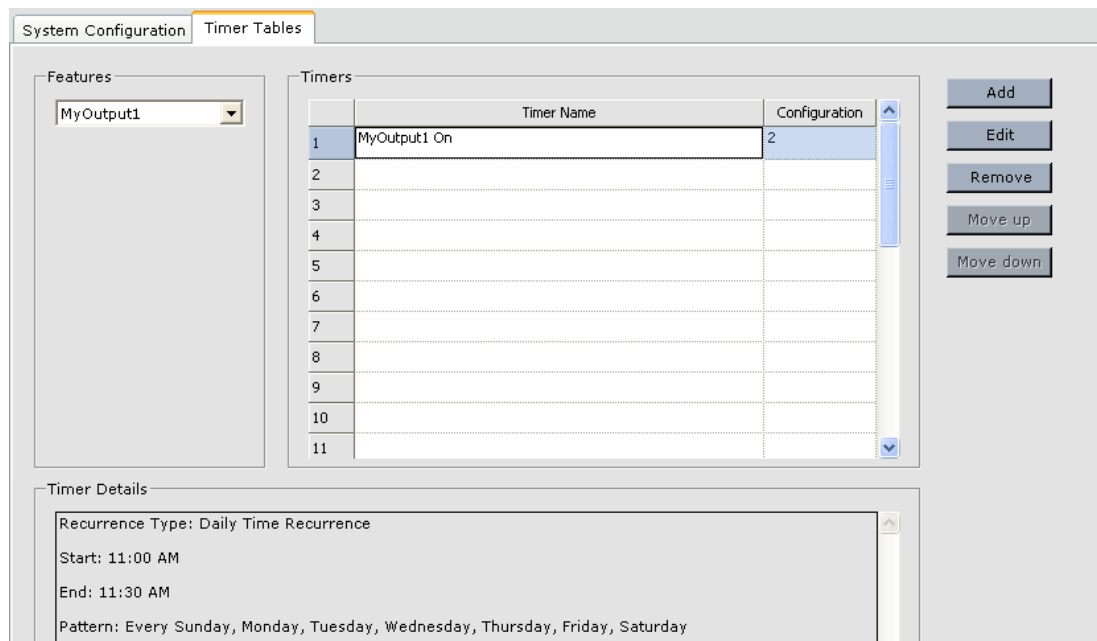
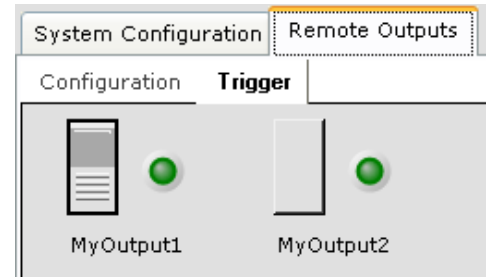
Remote outputs are available on the Central dispatcher and/or Local/Dispatcher's System IO. You can assigned them to terminals on an SC-ION Serial Input/Output Board using the System > Configuration > System I/O tab. Please refer to "Configuration Tabs - System I/O" on page 10-51. They can also be assigned to terminals on an ICE-MOR Multiple Output Relay Board using the Controller > Configuration > I/O Board tab. The user assigned output names appear on the list of outputs available for terminal assignment. Please refer to "Configuration - I/O Boards" on page 9-100.



Turning Remote Outputs On and Off:

Remote Outputs can be turned On an Off by clicking the graphical switches on the Remote Outputs > Trigger tab. The indicator lights when the output is On (actual output state depends on the active high/low setting). Toggle type outputs will turn themselves Off when the programmed Time expires.

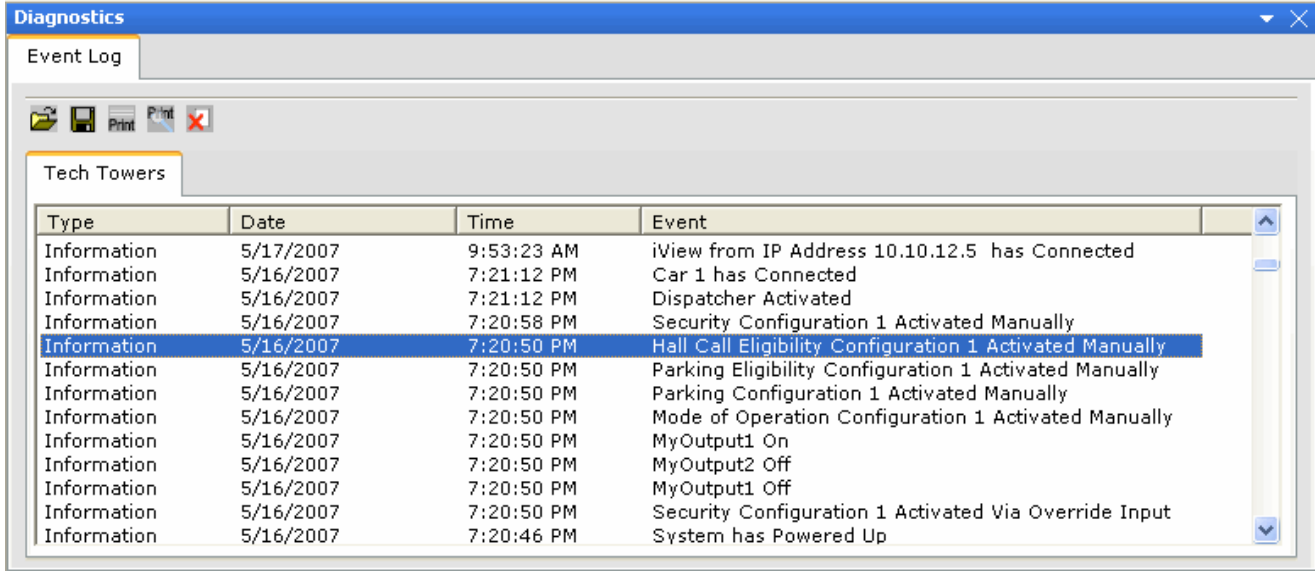
The first four Remote Outputs can also be turned On and Off using a System Timer. Please refer to "Configuration Tabs - Timer Tables (System)" on page 10-62.



Diagnostic Tabs - Event Log

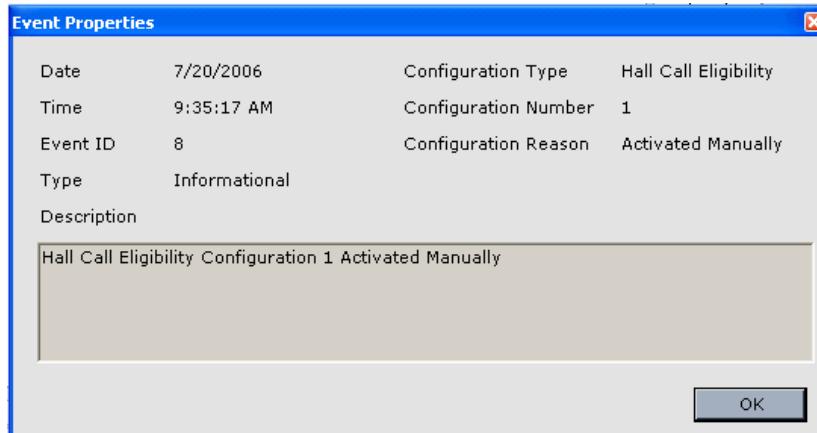
The System Event Log (System > Diagnostics > Event Log tab) provides a way to view the logged events associated with dispatching and group control. This is an essential troubleshooting tool. The System Event Log lists the following for each event logged:

- Type of event, Date, Time and Event



Type	Date	Time	Event
Information	5/17/2007	9:53:23 AM	iView from IP Address 10.10.12.5 has Connected
Information	5/16/2007	7:21:12 PM	Car 1 has Connected
Information	5/16/2007	7:21:12 PM	Dispatcher Activated
Information	5/16/2007	7:20:58 PM	Security Configuration 1 Activated Manually
Information	5/16/2007	7:20:50 PM	Hall Call Eligibility Configuration 1 Activated Manually
Information	5/16/2007	7:20:50 PM	Parking Eligibility Configuration 1 Activated Manually
Information	5/16/2007	7:20:50 PM	Parking Configuration 1 Activated Manually
Information	5/16/2007	7:20:50 PM	Mode of Operation Configuration 1 Activated Manually
Information	5/16/2007	7:20:50 PM	MyOutput1 On
Information	5/16/2007	7:20:50 PM	MyOutput2 Off
Information	5/16/2007	7:20:50 PM	MyOutput1 Off
Information	5/16/2007	7:20:50 PM	Security Configuration 1 Activated Via Override Input
Information	5/16/2007	7:20:46 PM	System has Powered Up


Event Properties To view greater detail about an event, double-click the event.




Date	7/20/2006	Configuration Type	Hall Call Eligibility
Time	9:35:17 AM	Configuration Number	1
Event ID	8	Configuration Reason	Activated Manually
Type	Informational		
Description	Hall Call Eligibility Configuration 1 Activated Manually		

OK



Save event log / Open event log The System Event Log can be saved to a file for future reference. To save a System Event Log to a file:

- Click the Save button  on the System > Diagnostics > Event Log tab.
- Navigate to the folder you want to save the file in.
- Name the file and click Save.

The Event Log file can be viewed using iView. To view a previously saved System Event Log file:

- Click the Open file button  on the System > Diagnostics > Event Log tab.
- Navigate to the file you want to view and double-click it.

Print / Print Preview To print the event log or to view a print preview and/or print the event log from the print preview dialog:

- Click the Print button  , choose a printer from the Print dialog and click Print.
- Click the Print Preview button  and use the controls to display and/or print the desired pages.

Clear All Click the Clear All button  to delete all of the events in the Event Log.

System - Hoistway

The hoistway display provides a real time view of all the cars in the group. A typical hoistway view, with an active call registration panel, is shown below.

Initially only one car is displayed. To view other cars:

- Use the horizontal scroll bar at the bottom of the Hoistway window.
- Move the mouse pointer to the left side of the window until the pointer changes to double arrows, then click and drag to the left to view more cars.

The screenshot displays the 'Hoistway' interface with four cars (1-4) and a call registration panel. The call registration panel includes a numeric keypad and call type options.

Car	Call Type	Call Number
1	Standard	2
2	Standard	15
3	Standard	30
4	Standard	47

The call registration panel shows a numeric keypad with the following call numbers highlighted in orange:

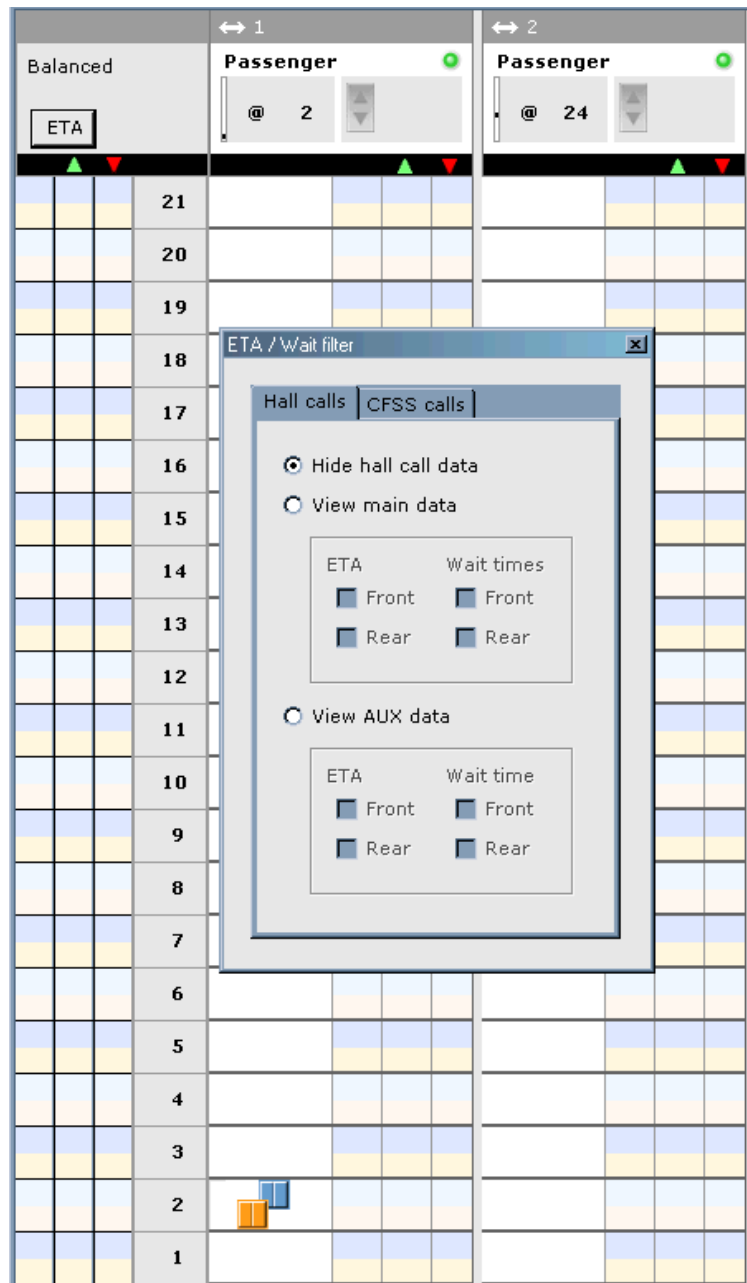
- 24
- 18
- 13
- 12

Call type options include: Standard (up/down arrows), Auxiliary (up/down arrows), CFSS 1 (star), and CFSS 2 (star). The panel also has 'Hall' and 'Car' tabs and a 'group' dropdown menu.

The supervisor column of the hoistway screen provides traffic mode and Estimated Time of Arrival information for the group.

Traffic Mode: (Balanced in this example) Displays the current operating mode. This mode may be selected manually, by timer, or automatically according to iCue analysis of real-time traffic conditions.

- **Balanced:** All elevator traffic within the building is receiving equal priority from the group.
- **Lobby Peak:** Designated lobby floors are receiving priority attention. Generally active during morning arrival times when traffic is heaviest departing the lobby for other floors.
- **Demand Up Peak:** Upward bound traffic is given priority. If assigned dynamically, made active when approximately 80% of building traffic is in the up direction.
- **Demand Down Peak:** Downward bound traffic is given priority. If assigned dynamically, made active when approximately 80% of building traffic is in the down direction.
- **Automatic:** The traffic mode is being controlled dynamically by iCue according to real time traffic analysis and learned building traffic patterns.



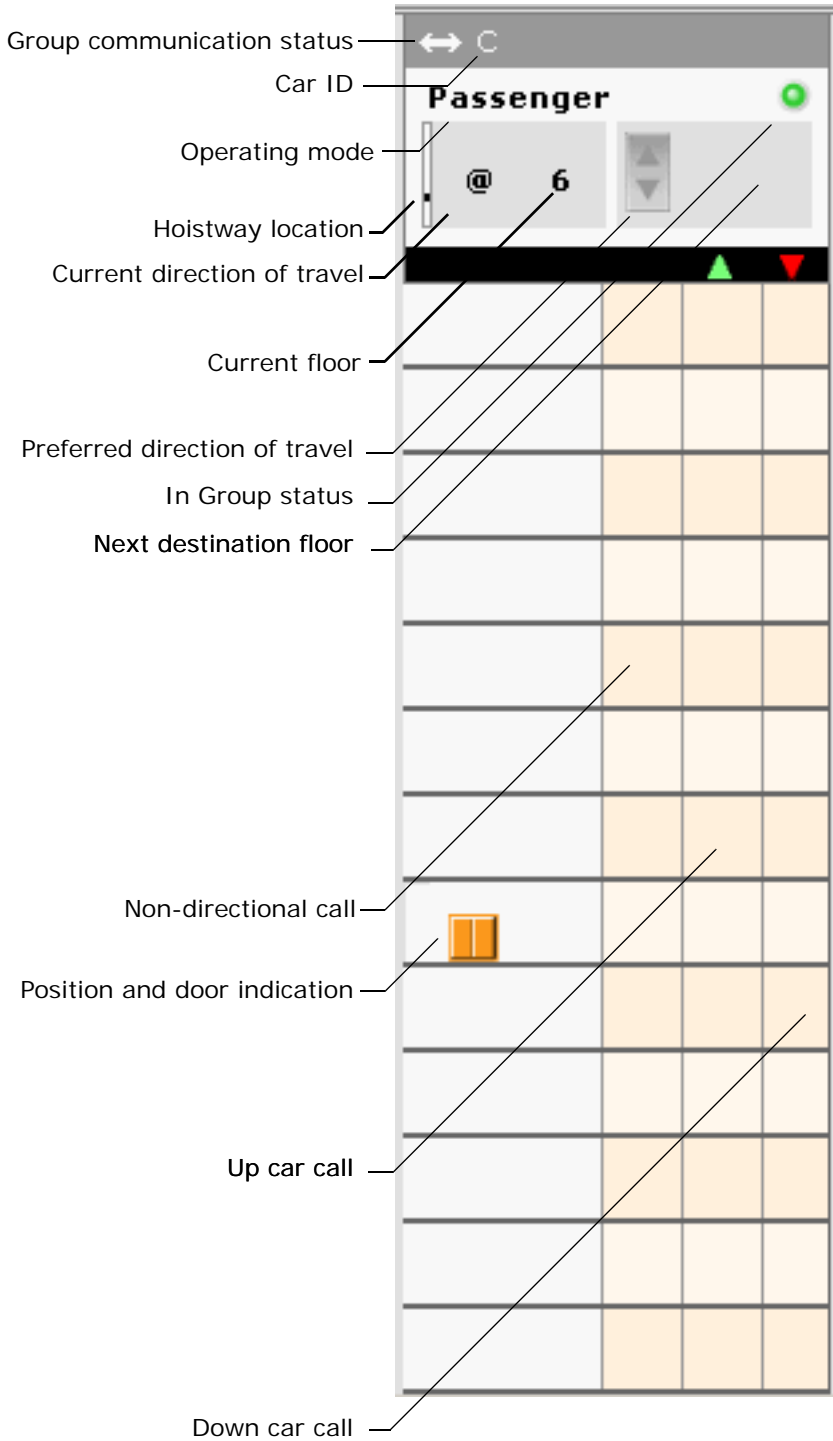
ETA: Estimated Time of Arrival. The time, in whole seconds, in which iCue estimates a registered hall call will be serviced. ETA counts in the blue zone indicate a rear hall call. ETA counts in the orange zone indicate a front hall call.

- **Up / Down Columns:** When a hall call is placed, its ETA will be displayed in the Up or Down (as appropriate) hall column next to the floor from which the car was placed. The ETA will count down to the arrival of the responding car.
- **Non-directional:** An ETA in the left-most column indicates a non-directional “hall” call has been placed at this floor. Non-directional calls are calls that do not indicate a requested direction of travel. For example, CFSS calls, EMS calls, etc.
- **ETA Filtering:** Click the ETA button to set up filtering criteria for displayed calls. (Dialog shown with supervisor column illustration.)

Per Car Display

For each car, the Hoistway display provides the following information:

- **Comm status:** As shown when communication is good. Separated by red slash and offset if communication is lost.
- **Car ID:** Car label.
- **Operating mode:** As listed previously.



Call Registration

Clicking the call registration button opens a dialog that allows you to register car and hall calls.

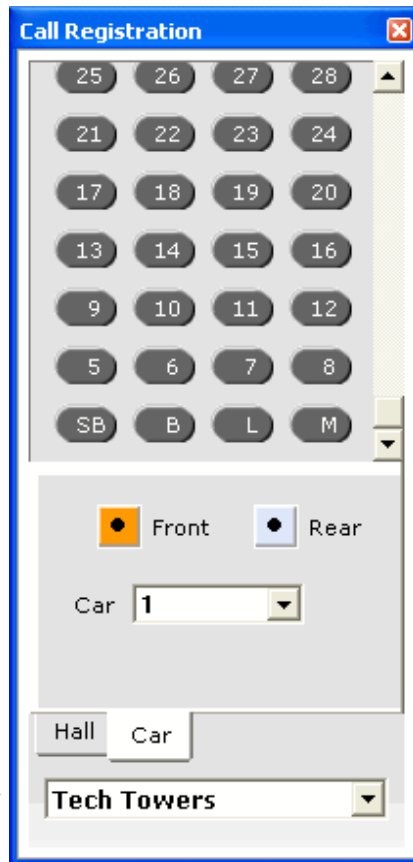


Car Calls After opening the dialog:

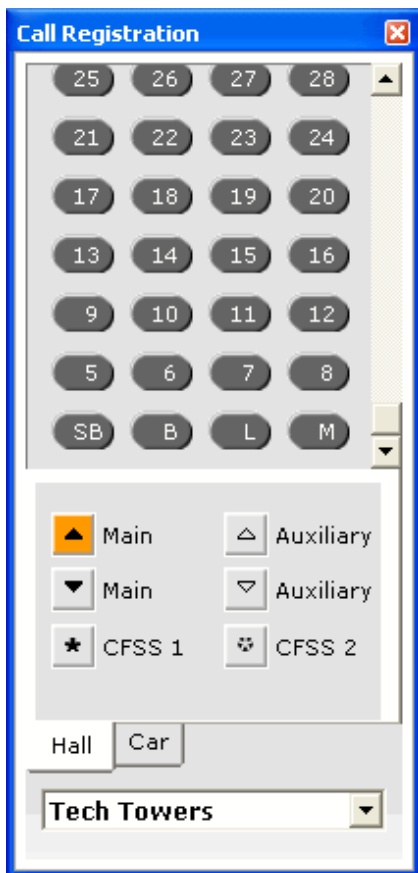
1. Click the Car tab.
2. Select the Car from the drop-down list (if applicable).
3. Select Front or Rear car panel if appropriate.
4. Click a floor number button to register a call.



Multiple calls may be placed if desired. Rear panel calls may be placed only if the panel exists and is configured.



Hall Calls After opening the dialog:



1. Click the Hall tab.
2. Select the hall call type.
 - Main (Up): Front up hall call.
 - Main (Down): Front down hall call.
 - CFSS1: Configure for Special Services. iControls have two customer assignable configurations. Typically they are used for hospital calls, VIP calls, etc.
 - Auxiliary (Up): Rear up hall call.
 - Auxiliary (Down): Rear down hall call.
 - CFSS2: Configure for Special Services. iControls have two customer assignable configurations. Typically they are used for hospital calls, VIP calls, etc.
3. Click a floor number button to register a call.

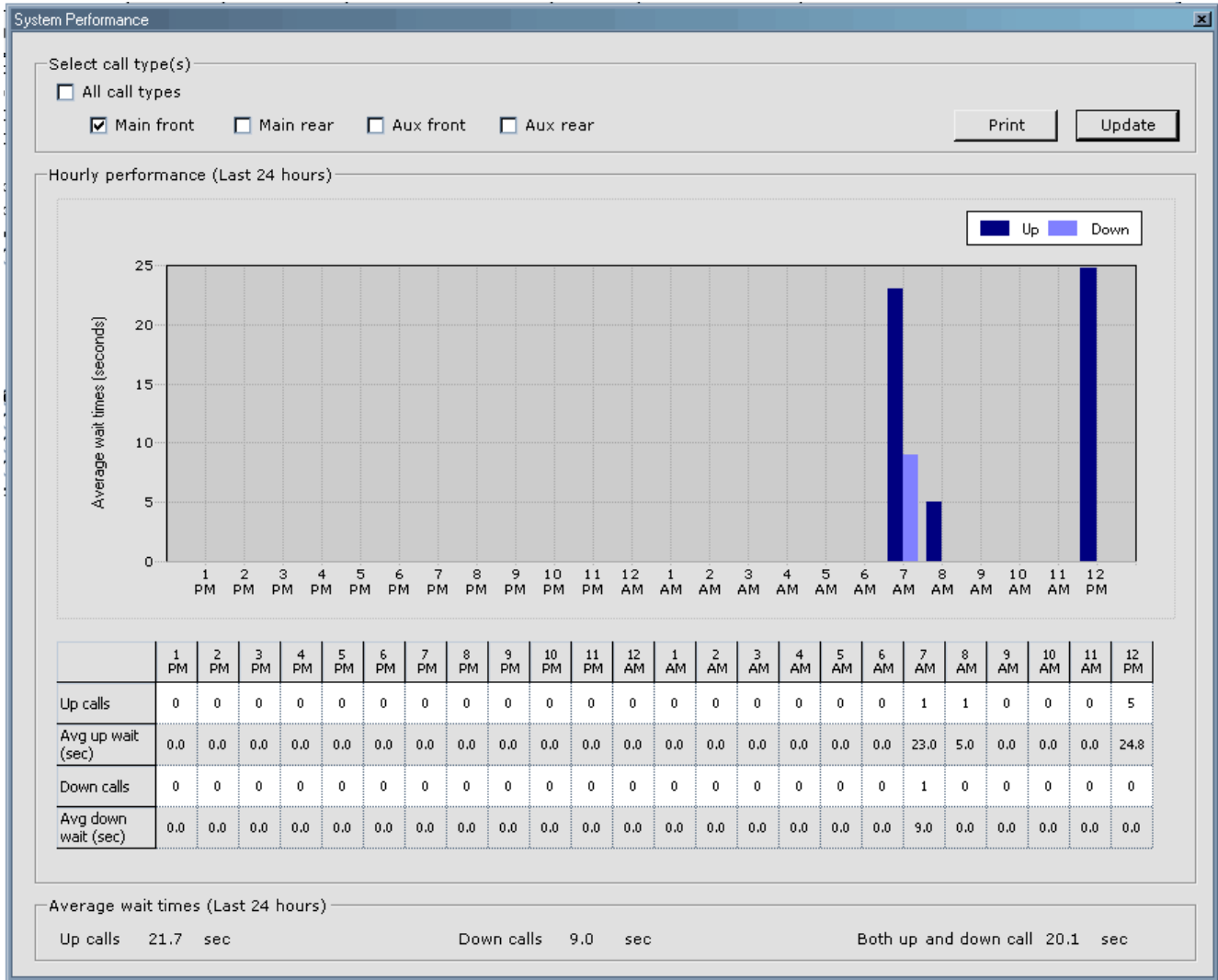
Multiple calls may be placed if desired. Only hall call types actually available and configured in the group will be available.



System Performance

This frame captures and graphs elevator performance over the most recent 24-hour period, including:

- Graphical representation of hourly average wait times for up and down hall calls
- Number of up and down hall calls answered each hour
- Average wait time for up and down hall calls for each hour
- Average wait time for up, down, and all hall calls during the last 24 hours



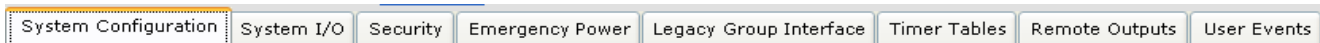
Information may be printed by clicking on the print button.

System - Layouts

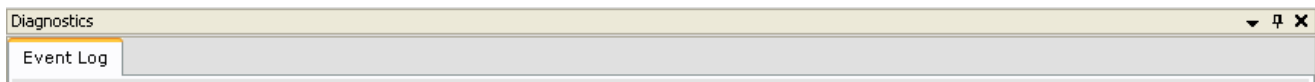
With iView, you can move and size tabs to suit the task to be performed. When you find a particularly arrangement to be useful, you can save it as a custom layout (View > Layouts > Save as). You can then display that layout at any time by selecting your custom layout from the View > Layouts > Custom menu.

Some useful layouts have been pre-programmed and are supplied with iView. They include:

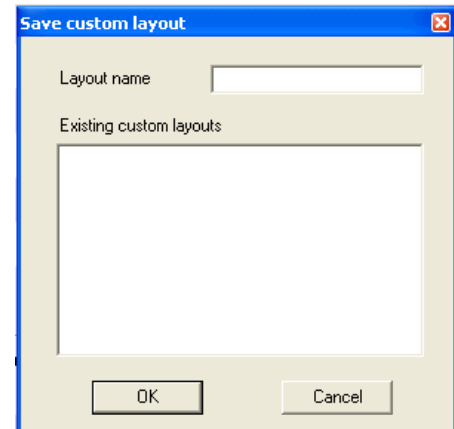
- **Configuration:** This layout displays all of the configuration tabs for easy selection.



- **Diagnostics:** Displays all of the diagnostic tabs for easy selection.



- **Default:** Displays the default (initial connection) layout.
- **Custom:** Used to select a custom layout to be displayed. This is the listing of custom layouts created using View > Layouts > Save as.
- **Save As:** Used to create and save a custom layout.
 - Enter the name for the custom layout.
 - Click OK.







Quick Topics

- [About this Section](#)
- [Specifications](#)
- [Software Test Points](#)
- [iBox Field Connections](#)
- [Terminal Field Connections](#)
- [System & LAN Ethernet](#)
- [TORQMAX F5 Parameters](#)
- [PowerBack R6 Parameters](#)



Reference



About this Section

This section contains detailed information about:

- **iControl AC Specifications** (see [page 11-2](#)).
- **Software Test Point Signals**: Descriptions of the signals that can be routed to hardware and software test points (see [page 11-3](#)).
- **iBox Field Connections**: Descriptions of field input and output connections on the left side of the iBox, including signal levels in active and inactive states (see [page 11-7](#)).
- **Terminal Field Connections** (see [page 11-14](#)).
- **System and LAN Ethernet**: Information about TCP/IP addresses (see [page 11-15](#)).
- **TORQMAX F5 Parameters Quick Reference**: A listing of TORQMAX F5 drive parameters and their default and typical settings (see [page 11-27](#)).
- **PowerBack R6 Parameters Quick Reference**: A listing of PowerBack R6 Regenerative drive parameters and their default and typical settings (see [page 11-31](#)).

iControl AC Specifications

Table 11.1 iControl AC Specifications

Parameter	Specification
Car Speed	Up to 700 fpm (2.5 m/s)
Jerk	15 ft/sec ³ (7.62 m/sec ³) maximum 8 ft/sec ³ (2.44 m/sec ³) nominal 1 ft/sec ³ (0.305 m/sec ³) minimum
Acceleration	10 ft/sec ² (3.04 m/sec ²) maximum 4 ft/sec ² (1.52 m/sec ²) nominal 1 ft/sec ² (0.31 m/sec ²) minimum
Number of Stops	Up to 150 (60 for Simplex operation)
Number of Cars in Group	Up to 20
Floor Leveling Accuracy	+/- 0.25 inches (6.35mm) guaranteed +/- 0.125 inches (3.18mm) typical
Minimum Floor to Floor Time	4.8 seconds for 12-foot (3.66m) floor heights if rotating equipment is capable of delivering the necessary torque.
Environmental Limits	32 to 104 degrees F (0—40 degrees C) ambient 12,000 ft (3,658m) altitude 95% relative humidity (non-condensing)

Software Test Point Signals

The iBox allows you to select any one of over fifty signals to display on-screen in iView or on the iBox LCD display at each of two “software test points.” A signal selected on a software test point (Test Point 1, Test Point 2) is also output on the corresponding iBox physical test point (STP 1, STP 2). For example, if you selected Brake Voltage on software Test Point 1, the Brake Voltage value would be displayed on screen and would also be output on iBox test point STP 1. Signals you can choose from are listed in the following table.

Raw signals are unprocessed signals directly from a source. They are frequently too “spikey” to use to read an average value but provide proof of activity and instantaneous reaction to changing conditions.

Filtered values represent the average, filtered value extrapolated from the raw signal to provide a viewable, “smoothed,” signal.

Table 11.2 Test Point Signals

Test Signal	Description / Text References
Acceleration (Command)	Post-filter, acceleration command signal.
Acceleration (Directional)	Directional acceleration signal.
Acceleration (Filtered)	Pre-filtered acceleration signal.
Acceleration (Interpolated)	Interpolated (smoothed) acceleration signal.
Acceleration (Raw)	Raw acceleration signal.
Acceleration (Slew)	Slew rate limited acceleration signal.
Armature Active Status	High = armature control enabled.
Armature Command Control	Filtered armature composite command.
Armature Command (Damped)	Damped armature composite command.
Armature Command (Raw)	Raw armature composite command.
Armature Composite Control	The summation of Armature Command Control and Armature Feed forward Control.
Armature Control Set	PID control sets that reflect standard, start (normal), stop (normal), steady-state (normal) and start (relevel) adjustment parameters. Normal: 0 = Idle - before motor contactor picks [PID - Standard] 1 = Idle - after motor contactor picks [PID - Start (normal)] 2 = Acceleration [PID - Standard] 3 = Peak [PID - Steady-State (normal)] 4 = Deceleration [PID - Standard] 5 = Flare [PID - Stop (normal)] 6 = Leveling [PID - Standard] 7 = Idle - before motor contactor drops [PID - Standard] Relevel: 8 = Idle - before motor contactor picks [PID - Standard] 9 = Idle - after motor contactor picks [PID - Start (relevel)] 10 = Acceleration - Leveling [PID - Standard]
Armature Current Dampen Feedback	Armature current dampening signal.
Armature Current Signal	Raw armature current feedback signal.
Armature Current Synthetic Feedback	Armature current synthetic speed signal used for internal speed reference and for current safety calibration.
Armature Differential Command	Armature differential command.
Armature Differential Gain	Armature differential gain.

Table 11.2 Test Point Signals

Test Signal	Description / Text References
Armature Error (Damped)	Dampened armature error signal.
Armature Error (Raw)	Raw armature error signal.
Armature Feedforward (Control)	Filtered armature feedforward command.
Armature Feedforward (Raw)	Raw armature feedforward command.
Armature Integral Command	Armature integral command.
Armature Integral Gain	Armature integral gain.
Armature On Status	High = PID control enabled.
Armature Proportional Command	Armature proportional command.
Armature Proportional Gain	Armature proportional gain.
Armature Voltage Dampen Feedback	Armature voltage dampening signal.
Armature Voltage Signal	Raw armature voltage feedback signal.
Armature Voltage Synthetic Feedback	Armature voltage synthetic speed signal used for internal speed reference and for voltage safety calibration.
Brake Contactor Status	Indicates status (open/closed) of brake contactor. When the signal is high, the contacts are closed. When the contactor is closed AND the brake field module is enabled, the brake will lift.
Brake Current Feedback	Filtered brake current feedback signal.
Brake Current Signal	Raw brake current feedback signal.
Brake Enable Status	Indicates status of signal that enables the brake field module. When high, the module is enabled. When the module is enabled AND the contactor is closed, the brake will lift.
Brake Voltage Feedback	Filtered brake voltage feedback signal.
Brake Voltage Signal	Raw brake voltage feedback signal.
DAC Offset Status	Indicates whether DAC signal offset is positive or negative.
Drive Enable Status	Indicates status of signal that enables the motor field module. When high, the module is enabled. When the module is enabled AND the contactor is closed, the motor will run.
Drive IOS Limit	This signal represents the hard-coded threshold at which an Inspection Overspeed will be tripped. 150fpm.
Drive IOS Param Limit	This signal represents the user-configurable threshold (Safety screen) at which an Inspection Overspeed will be tripped.
Encoder Signal	Raw encoder speed signal.
Field Active Status	High = motor field control enabled.
Field Command (Control)	Motor field composite command.
Field Control Path	MCE internal diagnosis only.
Field Current Feedback	Filtered motor field current feedback signal.
Field Current Signal	Raw motor field current feedback signal.
Field Error	Motor field error signal.
Field Integral Command	Motor field integral command.
Field Integral Gain	Motor field integral gain.
Field Proportional Command	Motor field proportional command.
Field Proportional Gain	Motor field proportional gain.
Field Voltage Feedback	Filtered motor field voltage feedback signal.
Field Voltage Signal	Raw motor field voltage feedback signal.
Load Weigher (Raw)	Analog load weigher signal, after amplification (adjusted by trimpot LW ADJ), at test point TP_LW on the CTP (cartop) board.
Load Weigher (Signal)	The controller's internal representation of the Load Weigher (Raw) signal.

Table 11.2 Test Point Signals

Test Signal	Description / Text References
Load Weigher Balanced	This signal is used to determine the amount of pretorque that the controller needs to provide to the motor to help prevent roll-back on takeoff. 0 = balanced load. Please refer to "Pretorque Gain Adjustments" on page 4-17.
Load Weigher Feedback	This signal represents the smoothed, processed Load Weigher (Signal), captured with doors closed, just before departure.
Motor Contactor Status	Indicates status (open/closed) of motor contactor. When the signal is high, the contacts are closed. When the contactor is closed AND the motor field module is enabled, the motor will run.
Over Current	Armature current signal used for Loop Over Current. Adjusted using Rated Loop Over Current and Loop Over Current Fault Time.
Over Current Power	Armature power accumulated. Used for Loop Over Current. Adjusted using Rated Loop Over Current and Loop Over Current Fault Time.
Over Current Power Threshold	The armature power threshold above which a Loop Over Current fault is generated. Adjusted using Rated Loop Over Current and Loop Over Current Fault Time.
Over Current Threshold	Armature current signal threshold above which over current power is accumulated. Used for Loop Over Current. Adjusted using Rated Loop Over Current and Loop Over Current Fault Time.
Pattern (Command)	Post-filtered pattern command signal. Please refer to "Verify Pattern Command and Drive Speed Feedback" on page 2-56. Please refer to "Verifying a One Floor Run" on page 4-5. Please refer to "Pattern Scaling" on page 4-8. Please refer to "Setting Pattern Parameters" on page 4-14.
Pattern (Directional)	Directional pattern signal.
Pattern (Filtered)	Pre-filtered pattern signal. Please refer to "Tach Error Tripping Threshold Adjustment" on page 2-59
Pattern (Interpolated)	Interpolated (smoothed) pattern signal.
Pattern (Phase)	The numbers displayed represent segments of the speed profile. Please refer to "Shaping the Speed Profile" on page 4-12. 0 = Idle 1 = Initial Jerk 2 = Acceleration 3 = Low Roll Jerk (during acceleration, high speed is reached) 4 = Peak (High Speed) 5 = High Roll Jerk (during acceleration, high speed not reached) 6 = High/Low Roll Jerk (during deceleration) 7 = Deceleration 8 = Flare Jerk (transition from deceleration to leveling) 9 = Approach Jerk (transition from deceleration to leveling) 10 = Leveling
Pattern (Raw)	Raw pattern signal.
Pattern (Region)	The numbers reflect a simplified representation of the speed profile in comparison to Pattern (Phase). 0 = Idle 1 = Acceleration 2 = Peak 3 = Deceleration 4 = Flare 5 = Leveling
Pattern (Slew Limited)	Slew rate limited pattern signal.

Table 11.2 Test Point Signals

Test Signal	Description / Text References
Position Bit	This signal represents car position/motion. It is abstracted from the motor velocity encoder or tach signal. The signal toggles low or high with every 32-inches of motor travel. Increasing frequency = increasing rate of position change.
Pre-Run Status	High = Pre-energizes motor field as doors are closing and demand occurs.
Pretorque (Command)	This is the actual pretorque signal sent to the drive and used to pretorque the motor. This is filtered representation of the raw pretorque "demand" signal, captured as the doors close and used to pretorque the motor as needed depending on the weight in the car.
Pretorque (Raw)	This is a representation of the raw pretorque "demand" signal. It will react to car load changes (i.e., doors open, passengers loading/unloading).
SCR Current Sensor Offset Status	High = SCR current sensor signal offset positive.
SCR Intg Offset Status	High = SCR integrator signal offset positive.
Speed Bit	When the car is still, this signal is high. When the car is traveling at a rate in excess of 40fpm, this signal is low.
Speed Feedback	Filtered speed feedback signal. Please refer to "Verify Pattern Command and Drive Speed Feedback" on page 2-56. Please refer to "Tach Error Tripping Threshold Adjustment" on page 2-59. Please refer to "Empty Car Tests" on page 3-31. Please refer to "Verifying a One Floor Run" on page 4-5. Please refer to "Setting Pattern Parameters" on page 4-14. Please refer to "Tach Error Tripping Threshold Adjustment" on page 4-41.
Sufficient Field Status	High = sufficient motor field current has been achieved. Different percentage of forcing, depending on mode. Inspection = 60% of forcing. Other, 80% of forcing.
Synthetic Signal	Speed signal synthesized from armature voltage and current.
Tach Error Lower Limit	This signal represents the lower margin of tach error allowed at contract speed before a tach fault is generated. Display with Speed Feedback signal to see the margin. If Speed Feedback crosses Tach Error Lower Limit the tach fault will be generated. Please refer to "Tach Error Tripping Threshold Adjustment" on page 2-59. Please refer to "Tach Error Tripping Threshold Adjustment" on page 4-41.
Tach Error Upper Limit	This signal represents the upper margin of tach error allowed at contract speed before a tach fault is generated. Display with Speed Feedback signal to see the margin. If Speed Feedback crosses Tach Error Upper Limit the tach fault will be generated. Please refer to "Tach Error Tripping Threshold Adjustment" on page 2-59. Please refer to "Tach Error Tripping Threshold Adjustment" on page 4-41.
Tachometer Signal	Raw tachometer signal.

iBox Field Connections

The majority of field connections to the iBox are made through pluggable terminal strips along the left edge of the iBox (as you face it). Field connections are control and data connections to and from equipment external to the iBox. For example, connections through the traveler cable to car and hoistway equipment or connections to additional machine room equipment like rope grippers, velocity encoders, governors, etc. In this section, three tables describe connections — iBox connections, expansion board connections, and iControl terminal connections respectively.

Table 11.3 iBox Field Connections

Source	Connection	Signal Description
TACH	TS	Tach positive signal. Analog. 0 - 30 VDC (15 VDC @ 1000 RPM).
	TC	Tach common (negative in respect to TS when car moving down)
	SHLD	Tach shield connection (connect at iBox-end only)
POSITION	DP1+	Positive going, +15V, digital pulse stream from iLand to iLink to iBox (DP1 leads DP2 when car moves up). Please refer to "iLand Landing System" on page 3-2.
	DP1-	Negative going, -15V, digital pulse stream from iLand to iLink to iBox.
	SHLD	Shield connection for twisted-pair DP1+/DP1-
	DP2+	Positive going, +15V, digital pulse stream from iLand to iLink to iBox (DP2 leads DP1 when car moves down)
	DP2-	Negative going, -15V, digital pulse stream from iLand to iLink to iBox
	SHLD	Shield connection for twisted-pair DP2+/DP2-
VELOCITY ENCODER	A+	Positive going, +12V, digital pulse from motor velocity encoder. Please refer to "Velocity Encoder Installation and Wiring" on page 2-24.
	A-	Negative going, -12V, digital pulse from motor velocity encoder.
	B+	Positive going, +12V, digital pulse from motor velocity encoder.
	B-	Negative going, -12V, digital pulse from motor velocity encoder.
	Z+	Positive going, +12V, digital pulse from motor velocity encoder.
	Z-	Negative going, -12V, digital pulse from motor velocity encoder.
	VE-	Encoder power return
	VE+	+12 VDC power to encoder (relative to VE-)

Table 11.3 iBox Field Connections

Source	Connection	Signal Description
CARTOP LINK	TX+	iBox transmit, positive going serial communication stream from iBox to iLink. Connects to iLink ICE-CTP Board terminal RX+. TX+ and TX- comprise a differential communications pair. Please refer to "Installing iLink" on page 3-13.
	TX-	iBox transmit, negative going serial communication stream from iBox to iLink. Connects to iLink ICE-CTP Board terminal RX-.
	SHLD	Shield connection for twisted-pair TX+/TX-
	RX+	iBox receive, positive going serial communication stream from iLink to iBox. Connects to iLink ICE-CTP board terminal TX+. RX+ and RX- comprise a differential communications pair.
	RX-	iBox receive, negative going serial communication stream from iLink to iBox. Connects to iLink ICE-CTP board terminal TX-.
	SHLD	Shield connection for twisted-pair RX+/RX-
CAR	DZ	Door Zone Sensor input. Activated = 110 VDC.
	ULM	Up Leveling Marker Sensor input. Activated = 110 VDC.
	DLM	Down Leveling Marker Sensor input. Activated = 110 VDC.
	INCT	Cartop Inspection Station INSP/AUTO Switch input. Activated = 110 VDC.
	ICTU	Cartop Inspection Station UP Button input (includes SAF button). Activated = 110 VDC.
	ICTD	Cartop Inspection Station DN Button input (includes SAF button). Activated = 110 VDC.
	INCP	COP Inspection Station INSP/AUTO Switch input. Activated = 110 VDC.
	ICPU	COP Inspection Station UP Button input. Activated = 110 VDC.
	ICPD	COP Inspection Station DN Button input. Activated = 110 VDC.
	INA	Car Panel (Hoistway) Access Enable switch input. 0 VDC active signal level. Off = 110 VDC.
	ESC	Car Panel Emergency Stop switch input. 0 VDC active signal level stops car. Off = 110 VDC.
	DCL	Door Close Limit input. Door fully closed, input inactive, 0 VAC. Door not closed signal level, 120 VAC.
	DOL	Door Open Limit input. Door fully open, input inactive, 0 VAC. Door not open signal level, 120 VAC.
DPM	Door Position Monitor input. Door closed, input inactive, 120 VAC. Door not closed, 0 VAC.	

Table 11.3 iBox Field Connections

Source	Connection	Signal Description
LIMITS	UNTD	Up Normal Limit Direction switch input. 110 VDC = input on/switch closed. 0 VDC = input off/switch open.
	UNT5	Up Slowdown Limit switch #5 input. 110 VDC = input on/switch closed. 0 VDC = input off/switch open.
	UNT4	Up Slowdown Limit switch #4 input. 110 VDC = input on/switch closed. 0 VDC = input off/switch open.
	UNT3	Up Slowdown Limit switch #3 input. 110 VDC = input on/switch closed. 0 VDC = input off/switch open.
	UNT2	Up Slowdown Limit switch #2 input. 110 VDC = input on/switch closed. 0 VDC = input off/switch open.
	UETS	Up Emergency Terminal Limit switch input. 110 VDC = input on/switch closed. 0 VDC = input off/switch open.
	UNT1	Up Slowdown Limit switch #1 input. 110 VDC = input on/switch closed. 0 VDC = input off/switch open.
	DNT1	Down Slowdown Limit switch #1 input. 110 VDC = input on/switch closed. 0 VDC = input off/switch open.
	DETS	Down Emergency Terminal Limit switch input. 110 VDC = input on/switch closed. 0 VDC = input off/switch open.
	DNT2	Down Slowdown Limit switch #2 input. 110 VDC = input on/switch closed. 0 VDC = input off/switch open.
	DNT3	Down Slowdown Limit switch #3 input. 110 VDC = input on/switch closed. 0 VDC = input off/switch open.
	DNT4	Down Slowdown Limit switch #4 input. 110 VDC = input on/switch closed. 0 VDC = input off/switch open.
	DNT5	Down Slowdown Limit switch #5 input. 110 VDC = input on/switch closed. 0 VDC = input off/switch open.
	DNTD	Down Normal Limit Direction switch input. 110 VDC = input on/switch closed. 0 VDC = input off/switch open.



Table 11.3 iBox Field Connections

Source	Connection	Signal Description
H/WAY	ATU	Hoistway Access Top Up switch input. When the Car Panel Access Enable switch (INA input) is on, an active input (key switch closure) here (110 VDC) will cause the car to move up the hoistway. A hoistway limit switch electrically between the ATU input and the activating switch will open and stop the car after it has moved the required distance up the hoistway (if installed). Normal/Off state = 0 VDC. Refer also to the -MRW drawing in the job prints.
	ATD	Hoistway Access Top Down switch input. When the Car Panel Access Enable switch (INA input) is on, an active input (key switch closure) here (110 VDC) will cause the car to move down the hoistway. A hoistway limit switch electrically between the ATD input and the activating switch will open and stop the car after it has moved the required distance down the hoistway (if installed). Normal/Off state = 0 VDC. Refer also to the -MRW drawing in the job prints.
	ABU	Hoistway Access Bottom Up switch input. When the Car Panel Access Enable switch (INA input) is on, an active input (key switch closure) here (110 VDC) will cause the car to move up the hoistway. A hoistway limit switch electrically between the ABU input and the activating switch will open and stop the car after it has moved the required distance up the hoistway (if installed). Normal/Off state = 0 VDC. Refer also to the -MRW drawing in the job prints.
	ABD	Hoistway Access Bottom Down switch input. When the Car Panel Access Enable switch (INA input) is on, an active input (key switch closure) here (110 VDC) will cause the car to move down the hoistway. A hoistway limit switch electrically between the ABD input and the activating switch will open and stop the car after it has moved the required distance down the hoistway (if installed). Normal/Off state = 0 VDC. Refer also to the -MRW drawing in the job prints.

Table 11.3 iBox Field Connections

Source	Connection	Signal Description
LOCKS/CONTACTS	GS	Gate Switch input. The gate switch makes up when the elevator doors close. When the switch is made, there will be 110 VDC on this input. When the switch is open, there will be 0 VDC on this input. The gate switch may be wired in series with other switches or locks on the elevator doors (as shown in the job prints) so that if any of the switches do not make, the GS input will remain low and the car will not run.
	DLAT	Door Lock Access Top input. When a top hoistway access is provided (see INA, ATU, and ATD), the hoistway door lock associated with that landing is connected between the #3 bus and this input. When the switch is made, there will be 110 VDC on this input. When the switch is open, there will be 0 VDC on this input and the car will not run unless INA is active and then only in response to the ATU or ATD input.
	DLMS	Door Lock Main String input. If top and bottom hoistway access (see INA, ATU, ATD, ABU, and ABD) is not provided, all hoistway door locks are wired in series between the #3 bus and DLMS. When the switches are made, there will be 110 VDC on this input. When any switch is open, there will be 0 VDC on this input and the car will not run.
	DLAB	Door Lock Access Bottom input. When a bottom hoistway access is provided (see INA, ABU, and ABD), the hoistway door lock associated with that landing is connected between the #3 bus and this input. When the switch is made, there will be 110 VDC on this input. When the switch is open, there will be 0 VDC on this input and the car will not run unless INA is active and then only in response to the ABU or ABD input.
	DCAT	Door Contact Access Top input. When a top hoistway access is provided (see INA, ATU, ATD, and DLAT), the hoistway door contact associated with that landing is connected between the #3 bus and this input. When the switch is made, there will be 110 VDC on this input. When the switch is open, there will be 0 VDC on this input and the car will not run unless INA is active and then only in response to the ATU or ATD input.
	DCMS	Door Contact Main String input. If top and bottom hoistway access (see INA, ATU, ATD, ABU, and ABD) is not provided, all hoistway door contacts are wired in series between the #3 bus and DCMS. When the switches are made, there will be 110 VDC on this input. When any switch is open, there will be 0 VDC on this input and the car will not run.
	DCAB	Door Contact Access Bottom input. When a bottom hoistway access is provided (see INA, ABU, ABD, and DLAB), the hoistway door contact associated with that landing is connected between the #3 bus and this input. When the switch is made, there will be 110 VDC on this input. When the switch is open, there will be 0 VDC on this input and the car will not run unless INA is active and then only in response to the ABU or ABD input.
	GOV	Governor input. The governor is connected between the #3 bus and this input. When the governor switch is made, there is 110 VDC on this input. If the governor switch trips/opens, there is 0 VDC on this input and the car will not run.
	SP 1	Spare input 1. If used, connect as shown in the job prints.

Table 11.3 iBox Field Connections

Source	Connection	Signal Description
BRAKE	BD	Brake Drive relay indicator. When the BD relay on the iBox IRB board is closed to pick the brake, this LED will light. Monitored by Safety Processor A.
	TB	Brake Triac active indicator. When the brake triac on the iBox IRB board is active (completes circuit for BD relay), this LED will light. Monitored by Safety Processor B.
	BRD	Brake Redundancy indicator. This LED lights when the main brake contactor drops out.
	BDRD	Brake Drive Redundancy indicator. This LED lights when the BD relay drops out.
DRIVE	MD	Motor Drive relay indicator. When the MD relay on the iBox IRB board is closed to enable the motor, this LED will light. Monitored by Safety Processor A.
	TM	Motor Triac active indicator. When the motor triac on the iBox IRB board is active (completes circuit for MD relay), this LED will light. Monitored by Safety Processor B.
	MRD	Motor Redundancy indicator. This LED lights when the main motor contactor drops out.
	MDRD	Motor Drive Redundancy indicator. This LED lights when the MD relay drops out.
SAFETY	SAFC	Safety Cartop input. Cartop safety relays and switches are wired in series between SAFH (Safety Hoistway) and SAFC. If any contact in the safety string opens, there will be 0 VDC on this input and the car will not run. If all safety contacts in the string are closed, there will be 110 VDC on this input.
	SAFH	Safety Hoistway input. Hoistway safety relays and switches are wired in series between the #3 bus and SAFH. The path also includes the Governor switch, with the GOV connection providing access to the #3 bus via the governor switch. (#3 to GOV through governor switch, GOV to SAFH through hoistway safety relays and switches). The job prints for the job provide specific wiring instructions. If any contact in the safety string opens, there will be 0 VDC on this input and the car will not run. If all safety contacts in the string are closed, there will be 110 VDC on this input.
SPARES	SP1 D	Optional input. Job prints will show if and how this is used on a per installation basis.
	SP2 D	Optional Brake Pick switch input. When brake is set = 110 VDC. When brake is picked (brake pick switch open) = 0 VDC.
	SP2	Optional input. Job prints will show if and how this is used on a per installation basis.
	SP3	Optional input. Job prints will show if and how this is used on a per installation basis.
	SP4	Optional input. Job prints will show if and how this is used on a per installation basis.

Table 11.3 iBox Field Connections

Source	Connection	Signal Description
COMMON	1	Common Bus connections. 0 V
	1	Common Bus connections. 0 V
	1	Common Bus connections. 0 V
	1	Common Bus connections. 0 V
120 VAC	2 PI	120 VAC. Fused, 2PI.
	2 PI	120 VAC. Fused, 2PI.
	2	120 VAC. Fused, F2.
	2	120 VAC. Fused, F2.
110 VDC	3 HA	110 VDC. Fused, F3HA.
	3 HA	110 VDC. Fused, F3HA.
	3	110 VDC. Fused, F3.
	3	110 VDC. Fused, F3.

Table 11.4 Expansion Board Connections

Board	Connection	Signal Description
MOR	Out 1 - Out 32	The MOR (Multiple Output Relay) board provides 32 outputs customers may use as needed for the particular job. Typical uses include activating chimes, buzzers, lights, etc. Each MOR board is configured according to the job survey for a particular job before the system is shipped. MOR boards may be installed in the iControl cabinet, in the iLink cartop box, or in the iCentral cabinet (for elevator group controller use). Output selection instructions are transmitted serially to the board. The 32 outputs are divided into five groups (1-4, 5-8, 9-16, 17-24, and 25-32). According to need, each group can be connected to provide the required output. Specific connections and output values are specified in the job prints.
MIAC	In 1 - In 32	The MIAC (Multiple Input AC) board provides 32 inputs customers may use as needed for the particular job. MIAC boards may be installed in the iControl cabinet, in the iLink cartop box, or in the iCentral cabinet (for elevator group controller use). Typical uses include car call buttons, operating mode switches, etc. Specific connections are detailed in the job prints. Please refer to "Input Signal Groups" on page 9-106.
SF Serial Fixture	CAR 1	Common connection. 0V.
	CAR +24	+24 VDC power to serial fixtures.
	CAR CDATA	Serial data stream to fixtures.
	HALL 1	Common connection. 0V.
	HALL +24	+24 VDC power to serial fixtures.
	HALL HDATA	Serial data stream to fixtures.

Table 11.4 Expansion Board Connections

Board	Connection	Signal Description
IEQ Earthquake	EQSP 1	Earthquake spare sensor input.
	ESS	Earthquake Seismic Switch input. Normally at 120 VAC. If seismic switch opens, 0 VDC. Press reset button on IEQ board to reset (after clearing any potential problems caused by quake).
	CW2	Along with CW1, "ring and string" input from counterweight movement sensor. Normally at 24 VDC.
	CW1	Along with CW2, "ring and string" input from counterweight movement sensor. Normally at 24 VDC.
RG Rope Gripper	RG1	24V DC power to rope gripper.
	RG2	Common. 0 VDC.
	RG5	Rope gripper input. Normally at 120 VAC. If rope gripper manual operation is selected, or if rope gripper is triggered, 0 V.
	RG7	120 VAC from #2 bus to rope gripper switches.

Field connections are also made to terminal strips in the iControl cabinet. Terminal connections provided vary from job to job depending upon need. Power distribution connections, beyond the basic three system buses, are specified in the job prints and are not included here.

Table 11.5 Controller Terminal Strip Connections

Label	Signal Description
B1, B2	DC power to motor brake. Voltage across terminals will vary depending upon brake control method (Low Current Brake Board or iField Brake Module). See your job prints. Significant voltage may be present even when brake is not picked.
MF1, MF2	DC power to motor field. Voltage across terminals will vary. Significant voltage may be present even if motor is not running.
15A	Final Limit switch. Wired as shown in job prints. 110 VDC when switch is made. 0 VDC when switch in string opens.
15B	Pit/Final Limit switch. Wired as shown in job prints. 110 VDC when switch is made. 0 VDC when switch in string opens.
1	System common.
2	120 VAC bus.
3	110 VDC bus.

System and LAN Ethernet

Communication between iControl elevator controllers and iCentral group control uses Ethernet TCP/IP (Transmission Control Protocol/Internet Protocol) over the **System** network. Communication between iControl elevator controllers and/or the iCentral group control and personal computers running iView or other iControl applications is over the **LAN** (Local Area Network) network. Cables used in the two systems are color-coded for easy recognition. **System** cables are **orange**. **LAN** cables are **blue**.

The following tables provide in-depth addressing information for the iControl/iCentral system.

MCE Direct-Connect Port (Links one iBox to one Laptop with iView)

IBox Direct Connect Port		" = same as above		
	IP	Subnet	Gateway	DNS
Any iBox	192.168.193.1	255.255.255.0	Blank or 0.0.0.0	Blank or 0.0.0.0
Any PC / Laptop	192.168.193.2	"	"	"
(MCE reserved)	All other addresses	"	"	"

Elevator LAN Network

Normally extends throughout a building and may span to other buildings, networks, or locations across the internet/intranet.

LAN Network Hub (Blue cables)				
	IP	Subnet	Gateway	DNS
(IEEE reserved)	192.168.191.0	255.255.255.0	192.168.191.254 *	192.168.191.254 *
Group 1 – LAN Network (Blue cables)				
	IP	Subnet	Gateway	DNS
iBox – Car 1	192.168.191.1	255.255.255.0	192.168.191.254 *	192.168.191.254 *
iBox – Car 2	192.168.191.2	"	"	"
iBox – Car 3	192.168.191.3	"	"	"
iBox – Car 4	192.168.191.4	"	"	"
iBox – Car 5	192.168.191.5	"	"	"
iBox – Car 6	192.168.191.6	"	"	"
iBox – Car 7	192.168.191.7	"	"	"
iBox – Car 8	192.168.191.8	"	"	"
iBox – Car 9	192.168.191.9	"	"	"
iBox – Car 10	192.168.191.10	"	"	"
iBox – Car 11	192.168.191.11	"	"	"
iBox – Car 12	192.168.191.12	"	"	"
iBox – Car 13	192.168.191.13	"	"	"
iBox – Car 14	192.168.191.14	"	"	"
iBox – Car 15	192.168.191.15	"	"	"
iBox – Car 16	192.168.191.16	"	"	"
iBox – Car 17	192.168.191.17	"	"	"
iBox – Car 18	192.168.191.18	"	"	"
iBox – Car 19	192.168.191.19	"	"	"
iBox – Car 20	192.168.191.20	"	"	"
iView	192.168.191.101 – 192.168.191.102	"	"	"
iCue	192.168.191.201 – 192.168.191.202	"	"	"
Group 2 – LAN Network (Blue cables)				
	IP	Subnet	Gateway	DNS
iBox – Car 1	192.168.191.21	255.255.255.0	192.168.191.254 *	192.168.191.254 *
iBox – Car 2	192.168.191.22	"	"	"
iBox – Car 3	192.168.191.23	"	"	"
iBox – Car 4	192.168.191.24	"	"	"
iBox – Car 5	192.168.191.25	"	"	"
iBox – Car 6	192.168.191.26	"	"	"
iBox – Car 7	192.168.191.27	"	"	"
iBox – Car 8	192.168.191.28	"	"	"
iBox – Car 9	192.168.191.29	"	"	"
iBox – Car 10	192.168.191.30	"	"	"
iBox – Car 11	192.168.191.31	"	"	"
iBox – Car 12	192.168.191.32	"	"	"

" = same as above

* = see Note #1

iBox – Car 13	192.168.191.33	"	"	"
iBox – Car 14	192.168.191.34	"	"	"
iBox – Car 15	192.168.191.35	"	"	"
iBox – Car 16	192.168.191.36	"	"	"
iBox – Car 17	192.168.191.37	"	"	"
iBox – Car 18	192.168.191.38	"	"	"
iBox – Car 19	192.168.191.39	"	"	"
iBox – Car 20	192.168.191.40	"	"	"
iView	192.168.191.103 – 192.168.191.104	"	"	"
iCue	192.168.191.203 – 192.168.191.204	"	"	"
Group 3 – LAN Network (Blue cables)				
	IP	Subnet	Gateway	DNS
iBox – Car 1	192.168.191.41	255.255.255.0	192.168.191.254 *	192.168.191.254 *
iBox – Car 2	192.168.191.42	"	"	"
iBox – Car 3	192.168.191.43	"	"	"
iBox – Car 4	192.168.191.44	"	"	"
iBox – Car 5	192.168.191.45	"	"	"
iBox – Car 6	192.168.191.46	"	"	"
...	...	"	"	"
iBox – Car 20	192.168.191.60	"	"	"
iView	192.168.191.105 – 192.168.191.106	"	"	"
iCue	192.168.191.205 – 192.168.191.206	"	"	"
Group 4 – LAN Network (Blue cables)				
	IP	Subnet	Gateway	DNS
iBox – Car 1	192.168.191.61	255.255.255.0	192.168.191.254 *	192.168.191.254 *
iBox – Car 2	192.168.191.62	"	"	"
iBox – Car 3	192.168.191.63	"	"	"
iBox – Car 4	192.168.191.64	"	"	"
iBox – Car 5	192.168.191.65	"	"	"
iBox – Car 6	192.168.191.66	"	"	"
...	...	"	"	"
iBox – Car 20	192.168.191.80	"	"	"
iView	192.168.191.107 – 192.168.191.108	"	"	"
iCue	192.168.191.207 – 192.168.191.208	"	"	"
Group 5 – LAN Network (Blue cables)				
	IP	Subnet	Gateway	DNS
iBox – Car 1	192.168.191.81	255.255.255.0	192.168.191.254 *	192.168.191.254 *
iBox – Car 2	192.168.191.82	"	"	"
iBox – Car 3	192.168.191.83	"	"	"
iBox – Car 4	192.168.191.84	"	"	"
iBox – Car 5	192.168.191.85	"	"	"
iBox – Car 6	192.168.191.86	"	"	"

...	...	"	"	"
iBox – Car 20	192.168.191.100	"	"	"
iView	192.168.191.109 – 192.168.191.110	"	"	"
iCue	192.168.191.209 – 192.168.191.210	"	"	"
Group 6– LAN Network (Blue cables)				
	IP	Subnet	Gateway	DNS
iBox – Car 1	192.168.191.121	255.255.255.0	192.168.191.254 *	192.168.191.254 *
iBox – Car 2	192.168.191.122	"	"	"
iBox – Car 3	192.168.191.123	"	"	"
iBox – Car 4	192.168.191.124	"	"	"
iBox – Car 5	192.168.191.125	"	"	"
iBox – Car 6	192.168.191.126	"	"	"
...	...	"	"	"
iBox – Car 20	192.168.191.140	"	"	"
iView	192.168.191.111 – 192.168.191.112	"	"	"
iCue	192.168.191.211 – 192.168.191.212	"	"	"
Group 7– LAN Network (Blue cables)				
	IP	Subnet	Gateway	DNS
iBox – Car 1	192.168.191.141	255.255.255.0	192.168.191.254 *	192.168.191.254 *
iBox – Car 2	192.168.191.142	"	"	"
iBox – Car 3	192.168.191.143	"	"	"
iBox – Car 4	192.168.191.144	"	"	"
iBox – Car 5	192.168.191.145	"	"	"
iBox – Car 6	192.168.191.146	"	"	"
...	...	"	"	"
iBox – Car 20	192.168.191.160	"	"	"
iView	192.168.191.113 – 192.168.191.114	"	"	"
iCue	192.168.191.213 – 192.168.191.214	"	"	"
Group 8 – LAN Network (Blue cables)				
	IP	Subnet	Gateway	DNS
iBox – Car 1	192.168.191.161	255.255.255.0	192.168.191.254 *	192.168.191.254 *
iBox – Car 2	192.168.191.162	"	"	"
iBox – Car 3	192.168.191.163	"	"	"
iBox – Car 4	192.168.191.164	"	"	"
iBox – Car 5	192.168.191.165	"	"	"
iBox – Car 6	192.168.191.166	"	"	"
...	...	"	"	"
iBox – Car 20	192.168.191.180	"	"	"
iView	192.168.191.115 – 192.168.191.116	"	"	"
iCue	192.168.191.215 – 192.168.191.216	"	"	"

Group 9 – LAN Network (Blue cables)				
	IP	Subnet	Gateway	DNS
iBox – Car 1	192.168.191.181	255.255.255.0	192.168.191.254 *	192.168.191.254 *
iBox – Car 2	192.168.191.182	"	"	"
iBox – Car 3	192.168.191.183	"	"	"
iBox – Car 4	192.168.191.184	"	"	"
iBox – Car 5	192.168.191.185	"	"	"
iBox – Car 6	192.168.191.186	"	"	"
...	...	"	"	"
iBox – Car 20	192.168.191.200	"	"	"
iView	192.168.191.117 – 192.168.191.118	"	"	"
iCue	192.168.191.217 – 192.168.191.218	"	"	"



#1: This parameter may have a site-dependant value depending on the unique DSL service or internet connection details. The default value shown can be used until a new value is identified. There may be more than one of these values provided.

Summary

This is a summary of the entire LAN IP address space including MCE supplied equipment and non-MCE supplied equipment.

LAN Network IP Address Summary Map For Network=192.168.191.*)	
	IP
(IEEE non-usable)	192.168.191.0
IBox (Groups 1, 2, 3 4, 5)	192.168.191.1 - 192.168.191.100
iView	192.168.191.101 - 192.168.191.120
IBox (Groups 6, 7, 8, 9)	192.168.191.121 - 192.168.191.200
ICue	192.168.191.201 - 192.168.191.220
iMonitor	192.168.191.221 - 192.168.191.222
With Optional Third-party Access	
3 rd -Party access address	192.168.191.223
With Optional Firewall / Router / Modem Dial-in	
DHCP addresses / VPN Tunnel addresses / Extra Dial-in addresses / Extra Static IP addresses	192.168.191.224 - 192.168.191.245
Static IP addresses	192.168.191.246 – 192.168.191.251
First Dial-in address	192.168.191.252
MCE Reserved	192.168.192.253
Firewall / Router	192.168.191.254
(IEEE non-usable)	192.168.191.255

Summary by Group

Group #1 – Floors () Machine Room Floor ()

Group #1 -iBox Direct Connect Port			“= same as above	
	IP	Subnet	Gateway	DNS
Any iBox	192.168.193.1	255.255.255.0	Blank or 0.0.0.0	Blank or 0.0.0.0
Any PC / Laptop	192.168.193.2	“	“	“
Group #1 -MCE System Network (Orange cables)				
iBox – Car 1	192.168.192.1	“	“	“
iBox – Car 2	192.168.192.2	“	“	“
iBox – Car 3	192.168.192.3	“	“	“
iBox – Car 4	192.168.192.4	“	“	“
iBox – Car 5	192.168.192.5	“	“	“
iBox – Car 6	192.168.192.6	“	“	“
iBox – Car 7	192.168.192.7	“	“	“
iBox – Car 8	192.168.192.8	“	“	“
iBox – Car 9	192.168.192.9	“	“	“
iBox – Car 10	192.168.192.10	“	“	“
iBox – Car 11	192.168.192.11	“	“	“
iBox – Car 12	192.168.192.12	“	“	“
iBox – Car 13	192.168.192.13	“	“	“
iBox – Car 14	192.168.192.14	“	“	“
iBox – Car 15	192.168.192.15	“	“	“
iBox – Car 16	192.168.192.16	“	“	“
iBox – Car 17	192.168.192.17	“	“	“
iBox – Car 18	192.168.192.18	“	“	“
iBox – Car 19	192.168.192.19	“	“	“
iBox – Car 20	192.168.192.20	“	“	“
iCue	192.168.192.201 – 192.168.192.202	“	“	“
Digi Hall Calls UDP 3000- 3007	192.168.192.211 – 192.168.192.214	“	“	“

Group #1 -LAN Network (Blue cables)				
iBox – Car 1	192.168.191.1	255.255.255.0	192.168.191.254 *	192.168.191.254 *
iBox – Car 2	192.168.191.2	"	"	"
iBox – Car 3	192.168.191.3	"	"	"
iBox – Car 4	192.168.191.4	"	"	"
iBox – Car 5	192.168.191.5	"	"	"
iBox – Car 6	192.168.191.6	"	"	"
iBox – Car 7	192.168.191.7	"	"	"
iBox – Car 8	192.168.191.8	"	"	"
iBox – Car 9	192.168.191.9	"	"	"
iBox – Car 10	192.168.191.10	"	"	"
iBox – Car 11	192.168.191.11	"	"	"
iBox – Car 12	192.168.191.12	"	"	"
iBox – Car 13	192.168.191.13	"	"	"
iBox – Car 14	192.168.191.14	"	"	"
iBox – Car 15	192.168.191.15	"	"	"
iBox – Car 16	192.168.191.16	"	"	"
iBox – Car 17	192.168.191.17	"	"	"
iBox – Car 18	192.168.191.18	"	"	"
iBox – Car 19	192.168.191.19	"	"	"
iBox – Car 20	192.168.191.20	"	"	"
iView	192.168.191.101 – 192.168.191.102	"	"	"
iCue	192.168.191.201 – 192.168.191.202	"	"	"

Group #2 – Floors () Machine Room Floor ()

Group #2 – LAN Network (Blue cables)				
iBox – Car 1	192.168.191.21	255.255.255.0	192.168.191.25 4 *	192.168.191.254 *
iBox – Car 2	192.168.191.22	"	"	"
iBox – Car 3	192.168.191.23	"	"	"
iBox – Car 4	192.168.191.24	"	"	"
iBox – Car 5	192.168.191.25	"	"	"
iBox – Car 6	192.168.191.26	"	"	"
iBox – Car 7	192.168.191.27	"	"	"
iBox – Car 8	192.168.191.28	"	"	"
iBox – Car 9	192.168.191.29	"	"	"
iBox – Car 10	192.168.191.30	"	"	"
iBox – Car 11	192.168.191.31	"	"	"
iBox – Car 12	192.168.191.32	"	"	"
iBox – Car 13	192.168.191.33	"	"	"
iBox – Car 14	192.168.191.34	"	"	"
iBox – Car 15	192.168.191.35	"	"	"
iBox – Car 16	192.168.191.36	"	"	"
iBox – Car 17	192.168.191.37	"	"	"
iBox – Car 18	192.168.191.38	"	"	"
iBox – Car 19	192.168.191.39	"	"	"
iBox – Car 20	192.168.191.40	"	"	"
iView	192.168.191.103 – 192.168.191.104	"	"	"
iCue	192.168.191.203 – 192.168.191.204	"	"	"

Group #3 – Floors () Machine Room Floor ()

Group #3 - LAN Network (Blue cables)				
iBox – Car 1	192.168.191.41	255.255.255.0	192.168.191.254 *	192.168.191.254 *
iBox – Car 2	192.168.191.42	"	"	"
iBox – Car 3	192.168.191.43	"	"	"
iBox – Car 4	192.168.191.44	"	"	"
iBox – Car 5	192.168.191.45	"	"	"
iBox – Car 6	192.168.191.46	"	"	"
...	...	"	"	"
iBox – Car 20	192.168.191.60	"	"	"
iView	192.168.191.105 – 192.168.191.106	"	"	"
iCue	192.168.191.205 – 192.168.191.206	"	"	"

Group 4 – Floors () Machine Room Floor ()

Group #4 - LAN Network (Blue cables)				
iBox – Car 1	192.168.191.61	255.255.255.0	192.168.191.254 *	192.168.191.254 *
iBox – Car 2	192.168.191.62	"	"	"
iBox – Car 3	192.168.191.63	"	"	"
iBox – Car 4	192.168.191.64	"	"	"
iBox – Car 5	192.168.191.65	"	"	"
iBox – Car 6	192.168.191.66	"	"	"
...	...	"	"	"
iBox – Car 20	192.168.191.80	"	"	"
iView	192.168.191.107 – 192.168.191.108	"	"	"
iCue	192.168.191.207 – 192.168.191.208	"	"	"

Group #5 – Floors () Machine Room Floor ()

Group #5 - LAN Network (Blue cables)				
iBox – Car 1	192.168.191.81	255.255.255.0	192.168.191.254 *	192.168.191.254 *
iBox – Car 2	192.168.191.82	"	"	"
iBox – Car 3	192.168.191.83	"	"	"
iBox – Car 4	192.168.191.84	"	"	"
iBox – Car 5	192.168.191.85	"	"	"
iBox – Car 6	192.168.191.86	"	"	"
...	...	"	"	"
iBox – Car 20	192.168.191.100	"	"	"
iView	192.168.191.109 – 192.168.191.110	"	"	"
iCue	192.168.191.209 – 192.168.191.210	"	"	"

Group #6 – Floors () Machine Room Floor ()

Group #6 - LAN Network (Blue cables)				
iBox – Car 1	192.168.191.121	255.255.255.0	192.168.191.254 *	192.168.191.254 *
iBox – Car 2	192.168.191.122	"	"	"
iBox – Car 3	192.168.191.123	"	"	"
iBox – Car 4	192.168.191.124	"	"	"
iBox – Car 5	192.168.191.125	"	"	"
iBox – Car 6	192.168.191.126	"	"	"
...	...	"	"	"
iBox – Car 20	192.168.191.140	"	"	"
iView	192.168.191.111 – 192.168.191.112	"	"	"
iCue	192.168.191.211 – 192.168.191.212	"	"	"

Group #7 – Floors () Machine Room Floor ()

Group #7 - LAN Network (Blue cables)				
iBox – Car 1	192.168.191.141	255.255.255.0	192.168.191.254 *	192.168.191.254 *
iBox – Car 2	192.168.191.142	"	"	"
iBox – Car 3	192.168.191.143	"	"	"
iBox – Car 4	192.168.191.144	"	"	"
iBox – Car 5	192.168.191.145	"	"	"
iBox – Car 6	192.168.191.146	"	"	"
...	...	"	"	"
iBox – Car 20	192.168.191.160	"	"	"
iView	192.168.191.113 – 192.168.191.114	"	"	"
iCue	192.168.191.213 – 192.168.191.214	"	"	"

Group #8 – Floors () Machine Room Floor ()

Group #8 - LAN Network (Blue cables)				
iBox – Car 1	192.168.191.161	255.255.255.0	192.168.191.254 *	192.168.191.254 *
iBox – Car 2	192.168.191.162	"	"	"
iBox – Car 3	192.168.191.163	"	"	"
iBox – Car 4	192.168.191.164	"	"	"
iBox – Car 5	192.168.191.165	"	"	"
iBox – Car 6	192.168.191.166	"	"	"
...	...	"	"	"
iBox – Car 20	192.168.191.180	"	"	"
iView	192.168.191.115 – 192.168.191.116	"	"	"
iCue	192.168.191.215 – 192.168.191.216	"	"	"

Group #9 – Floors () Machine Room Floor ()

Group #9 - LAN Network (Blue cables)				
iBox – Car 1	192.168.191.181	255.255.255.0	192.168.191.254 *	192.168.191.254 *
iBox – Car 2	192.168.191.182	"	"	"
iBox – Car 3	192.168.191.183	"	"	"
iBox – Car 4	192.168.191.184	"	"	"
iBox – Car 5	192.168.191.185	"	"	"
iBox – Car 6	192.168.191.186	"	"	"
...	...	"	"	"
iBox – Car 20	192.168.191.200	"	"	"
iView	192.168.191.117 – 192.168.191.118	"	"	"
iCue	192.168.191.217 – 192.168.191.218	"	"	"

TORQMAX F5 Drive Parameters Quick Reference

This section includes quick reference information for the TORQMAX F5 drive parameters. Please refer to the F5 drive manual provided with the iControl for a detailed explanation.



Caution

For Permanent magnet (PM Synchronous) motors, consult the following sections of the TORQMAX F5 Drive manual before roping the machine, 5.5 *PM Synchronous Motors*, 5.8 *Encoder Feedback* and 5.11 *Running the Motor*.

Table 11.6 TORQMAX F5 Drive Parameters Quick Reference for iControl AC

WARNING: Do not change drive parameters while the elevator is running. Incorrect drive parameters can cause erratic elevator operation. Parameters with an asterisk (*) must be set correctly for your specific motor/machine. Refer to the drive adjustment manual for detailed information.

Digital Operator Display	Parameter Description	Unit	Setting Range	Default Setting	Factory Setting
LF.02	Signal operating mode: AbSpd = Absolute Analog Speed d SPd = Digital speed control A tor= Analog torque control A Spd= Analog speed control SErSP = Serial Com. Speed Control bnSPd = Binary Speed Selection S POS = Serial Position Feedback	-	AbSpd d SPd A tor A Spd SErSP bnSPd	bnSPd	* _____
LF.03	Drive configuration: run = run mode conF = Configuration (5 minute time limit) Stop = Drive Stopped, Motor cannot run. S Lrn = activate auto tune I Lrn = Inertia Learn. Learns system inertia. P Lrn = Pole Learn. PM motor pole positions. SPI = Learns absolute encoder position for PM motor without sheave movement. **** OStST = Allows car to over speed for one run without changing drive parameters (see also LF.49).****	-	run conF Stop S Lrn I Lrn P Lrn SPI OStST	conF	run
LF.04	Motor selection: Displays mode selected using US.4 and US.10	-	Read only. See US.10	-	***
LF.05	Drive fault auto reset	1	0-10	5	5
LF.08	Electronic motor overload protection	-	on/off	off	on
LF.09	Electronic overload current: PM- Not visible, auto set same as LF.12.	A	1.0 - 110% Rtd	8.0	* _____
LF.10	Rated motor power PM- Read only, auto calc.	HP	0.00 - 125.00	5.0	IM* _____
LF.11	Rated motor speed	rpm	10.0-6000	1165 or 150	* _____
LF.12	Rated motor current	A	1.0 - 110% Drive rated	8.0	* _____
LF.13	Rated motor frequency	Hz	4.0 - 100.0	60.0	* _____
LF.14	Rated motor voltage IM - Name plate rated voltage (120 - 500V) PM - No-load, phase-to-phase back EMF rms voltage LF.11 (1 - 32000V/krpm)	V	-	230/460	* _____

Table 11.6 TORQMAX F5 Drive Parameters Quick Reference for iControl AC

LF.15	IM: Power factor, PM: not visible	1	0.50 - 1.00	0.90	0.90
LF.16	IM: Field weakening speed PM - not visible	rpm	0.0-6000.0	set @ 80%of LF.11	* _____
Digital Operator Display	Parameter Description	Unit	Setting Range	Default Setting	Factory Setting
LF.17	Rated motor torque, IM- Read only, auto calc. PM- enter motor name plate torque	lb ft	1 - 10000	IM - calc PM - 18	IM *** PM* _____
LF.18	PM: Motor stator resistance - from data sheet or perform learn procedure (see F5 Drive manual) IM: not visible	ohms	0.0-50.0	49.999	PM* _____
LF.19	PM: Motor leakage inductance - from data sheet or learn procedure (see F5 Drive manual) IM: not visible	mH	0.1 - 500.0	1.00	PM* _____
LF.20	Contract Speed	fpm	0 - 1600	0	* _____
LF.21	Traction sheave diameter (measured value)	inch	7.0 - 80.0	24.00	* _____
LF.22	Gear reduction ratio	1	1.00-99.99	30.00	* _____
LF.23	Roping ratio	1	1 - 8	1	* _____
LF.24	Load weight	lbs	0 - 30000	0	* _____
LF.25	Estimated gear ratio (Read only, auto calc.)	.01	1.00 - 99.99	calculated	***
0.LF.26	Encoder Interface: Displays feedback type		-	-	***
LF.27	Encoder pulse number For IncIE and SinCo see customer data For HIPEr set to 1024 For EndAt set to 2048	ppr	256 - 16835	1024	
LF.28	Encoder channel swap / direction 0 nothing reversed 1 encoder A<->B swapped 2 motor rotation reversed 3 motor rotation reversed and A<->B swapped	1	0 - 3	0	* _____
LF.29	Encoder sample time (recommend gearless = 4, geared = 8)	mSec	0.5 - 32	4	4 or 8 * _____
LF.30	Control mode: 0, 1 = Open loop induction motor operation 2 = Closed loop speed control (LF. 2 = A Spd) 3 = Closed loop speed fcontrol with pre-torque 4 = Closed loop torque control (LF. 2 = A tor) 5 = Closed loop speed control with synthesized pre-torque	1	0 - 4	0	* _____
A.LF.31	Kp speed accell: Proportional gain, accel & run	1	1 - 50396	3000	** 3000
d.LF.31	Kp speed decell: Proportional gain, decel	1	1 - 50396	3000	** 3000
P.LF.31	KP speed torque (Synth. Pretorque)	1	1 - 50396	2000	2000
A.LF.32	Ki speed accell: Integral gain, accel & run	1	1 - 26214	350	** 350
d.LF.32	Ki speed decell: Integral gain, decel	1	1 - 26214	250	** 250
P.LF.32	Ki speed torque (Synth. Pretorque)	1	1 - 26214	10000	10000
A.LF.33	Ki speed offset accell: Gain at low speed, accel	1	0 - 8000	3000	** 3000
d.LF.33	Ki speed offset decell: Gain at low speed, decel	1	0 - 8000	1000	** 1000
0.LF.36	Maximum torque (auto calculated by the drive)	lb.ft.	0-500% Trtd	calculated	***
1.LF.36	Maximum torque emergency operation (= LF.17)	lb.ft.	0-500% Trtd	calculated	***

TORQMAX F5 Drive Parameters Quick Reference

Table 11.6 TORQMAX F5 Drive Parameters Quick Reference for iControl AC

LF.37	Open loop torque boost: Open loop op. only	%	0-25.5	10.0	10.0
LF.38	Carrier frequency; 0= 8 KHz, 1= 16KHz (Note: set LF.38 = 0 if E.OL2 error on drive)	1	0, 1	0	*
Digital Operator Display	Parameter Description	Unit	Setting Range	Default Setting	Factory Setting
LF.41	Leveling speed (Not used, must be set to 0)	fpm	0 - 25	0.0	0.0
LF.42	High speed	fpm	0 - LF.20	0.0	* _____
LF.43	Inspection speed (Not used, must be set to 0)	fpm	0 - 150.00	0.0	0.0
LF.44	High leveling speed (Not used, must be set to 0)	fpm	-	0.0	0.0
LF.45	Earthquake speed (Not used, must be set to 0)	fpm	-	0.0	0.0
LF.46	Emerg. power Speed (Not used, must be set to 0)	fpm	-	0.0	0.0
LF.47	Intermediate speed (Not used, must be set to 0)	fpm	-	0.0	0.0
LF.49	Over Speed Function Test: speed setting for Over Speed Test Function (see LF.3 - OStST). ****	fpm	1 - 2400	100	100
Note: Parameters LF.50 through LF.56 default to off when LF. 2 is set to AbSPd, A Spd or A Tor.					
0.LF.50	Profile 0 - Starting jerk (Not used)	ft/s ³	see note	see note	off
0.LF.51	Profile 0 - Acceleration (Not used)	ft/s ²	see note	see note	off
0.LF.52	Profile 0 - Deceleration jerk (Not used)	ft/s ³	see note	see note	off
0.LF.53	Profile 0 - Deceleration jerk (Not used)	ft/s ²	see note	see note	off
0.LF.54	Profile 0 - Deceleration jerk (Not used)	ft/s ³	see note	see note	off
0.LF.55	Profile 0 - Approach jerk (Not used)	ft/s ³	see note	see note	off
1.LF.50	Profile 1 - Starting jerk (Not used)	ft/s ³	see note	see note	off
1.LF.51	Profile 1 - Acceleration (Not used)	ft/s ²	see note	see note	off
1.LF.52	Profile 1 - Deceleration jerk (Not used)	ft/s ³	see note	see note	off
1.LF.53	Profile 1 - Deceleration jerk (Not used)	ft/s ²	see note	see note	off
1.LF.54	Profile 1 - Deceleration jerk (Not used)	ft/s ³	see note	see note	off
1.LF.55	Profile 1 - Approach jerk (Not used)	ft/s ³	see note	see note	off
2.LF.50	Profile 2 - Starting jerk (Not used)	ft/s ³	see note	see note	off
2.LF.51	Profile 2 - Acceleration (Not used)	ft/s ²	see note	see note	off
2.LF.52	Profile 2 - Deceleration jerk (Not used)	ft/s ³	see note	see note	off
2.LF.53	Profile 2 - Deceleration jerk (Not used)	ft/s ²	see note	see note	off
2.LF.54	Profile 2 - Deceleration jerk (Not used)	ft/s ³	see note	see note	off
2.LF.55	Profile 2 - Approach jerk (Not used)	ft/s ³	see note	see note	off
LF.56	Stop jerk (Not used)	ft/s ³	see note	see note	off
LF.57	Speed following error (0 = off, 1 = on)	-	off, on	on	on
LF.58	Speed difference	%	0 - 30	10	10
LF.59	Trigger time speed difference: Following error timer	sec	0.0 -1.0	1.0	1.0
LF.61	Emergency operation mode	-		off	off
LF.67	Pretorque gain	-	0.25 - 2.00	1.00	1.00
LF.68	Pretorque offset	%	-100 - 100	0.00	0.00
LF.69	Pretorque direction (-1 = -V, 1 = +V)	1	-1, 1	1	1
LF.70	Speed pick delay (Delay to turn on DRO).	sec	0.00 - 3.00	0.30	0.30
LF.71	Brake pick delay	sec	0.0 - 3.0	0.05	0.05
LF.76	Encoder resolution multiplier 2 for incremental encoder 8 for Sin/Cos, EnDat or Hiperface encoder	1	0 - 13	2	
LF.77	Absolute encoder position (measured)	1	0 - 65535h	0	0



Table 11.6 TORQMAX F5 Drive Parameters Quick Reference for iControl AC

LF.78	Brake drop delay: Time motor will hold full current and control after direction inputs drop.	sec	0.0-3.00	0.50	0.50
LF.79	Current hold time: Delay in turning off the drive (Delay to turn OFF the motor current after the direction is dropped and LF.78 has expired)	sec	0.300 - 3.000	0.300	0.30 - 0.80
Diagnostic Parameters (Read only)					
LF.25	Estimated gear ratio	1			
LF.80	Software version				
LF.81	Software date		MMDD.Y		
LF.82	X2A-input state		see tables in F5 Drive Manual		
LF.83	X2A-output state				
LF.86	Operational mode				
LF.87	Actual inverter load (100% = rated load)	%			
LF.88	Motor command speed	rpm			
LF.89	Actual motor speed	rpm			
LF.90	Actual elevator speed	ft/m			
LF.93	Phase current	A			
LF.94	Peak phase current	A			
LF.95	Actual DC voltage	V			
LF.96	Peak DC Voltage	V			
LF.97	Actual output frequency	Hz			
O.LF.98	Last error				
US - Parameters					
US. 1	Password: With different passwords, different parameter groups can be accessed for advanced programming.	-	0-9999	-	-
US. 3	Load defaults. Select LoAd and press ENTER to cause all LF parameters to be reset to drive default values.	-	LoAd	-	-
US. 4	Load configuration. Select LoAd and press ENTER to load the configuration selected in US.10.	-	LoAd	-	-
US.10	Select Configuration. User selection of drive mode. I CLSd = Induction motor (closed loop) I 9LSS = Induction motor (closed loop) gearless P CLSd = Synchronous motor (closed loop) P 9LSS = Synchronous motor (closed loop)gearless Loaded using parameter US.04.	-	I CLSd I 9LSS P CLSd P 9LSS	-	*
<p>* Parameters are motor/machine/job dependent. ** Recommended but field adjustable. *** The value is automatically calculated from the motor data or other parameter values. ****Parameters apply to Drive Software Version 1.71 or greater)</p>					
Parameters for Drive Software Version (LF.80 = 1.61 or greater), Software date (LF.81 = 2801.9 or later)					
Job #:			Drive Serial #:		
Prod. Order #:			Test technician:		
Drive Model #:			Date:		

PowerBack R6 Regenerative Drive Quick Reference

This section includes quick reference information for the PowerBack R6 Regenerative AC drive. Please refer to the R6 Regenerative drive manual provided with the iControl for detailed explanation of the parameters.

Table 11.7 Quick Reference for PowerBack R6 Regenerative Drive

WARNING: Do not change drive parameters while the elevator is running. Incorrect values of drive parameters can cause erratic elevator operation.				
Display	Parameter Description	Setting Range	Resolution	Field/MCE Setting
CP. 0	Password input	0...9999	1	---
CP. 1	Status display	---	---	---
CP. 2	Main Line Frequency	---	0.1 Hz	---
CP. 3	AC-Phase current L1	---	0.1 A	---
CP. 4	AC-Phase current L2	---	0.1 A	---
CP. 5	AC-Phase current L3	---	0.1 A	---
CP. 6	Actual Load	---	1%	---
CP. 7	Actual Load / peak value	---	1%	---
CP. 8	DC output current	---	0.1 A	---
CP. 9	Actual DC voltage	---	1 V	---
CP.10	DC voltage / peak value	---	1 V	---
CP.11	Heat sink temperature	---	1 °C	---
CP.12	Over load counter	---	1%	---
CP.13	Active power	---	0.1kW	---
CP.14	Total regen kWhr counter	---	0.1 kWh	---
CP.15	Total motor kWhr counter	---	0.1 kWh	---
CP.16	Total net kWhr counter	---	0.1 kWh	---
CP.17	Apparent power / Line input	---	0.1 kVA	---
CP.18	Analog output 1 / amplification factor	-20.00...20.00	0.01	1.00
CP.19	DC bus switching level	+/- 30000.00	0.01	Set to 260 for 208 - 240Vac Set to 600 for 460 - 480Vac
CP.20	Auto error reset counter	0...10	1	3
CP.21	Last Error	---	---	---
CP.22	Last Error 1	---	---	---
CP.23	Last Error 2	---	---	---
CP.24	Last Error 3	---	---	---
CP.25	Last Error 4	---	---	---
CP.26	Last Error 5	---	---	---
CP.27	Last Error 6	---	---	---
CP.28	Last Error 7	---	---	---
CP.29	Software version	---	---	---
CP.30	Software date code	DDMM.Y	---	---
CP.31	Power part ID code	---	---	Set to 250 for 208 - 240Vac Set to 253 for 460 - 480Vac
CP.32*	Pulse off Level	-100kW...0.0kW	0.1kW	-0.8kW
CP.33*	Operating Mode 0: Master with Commutation Choke 2: Slave with Commutation Choke	0...3	1	Set to 0 for Main Regen drive Set to 2 for Second drive
CP.34*	Control Angle	0.0...60.0	0.1	29.0

*NEW PARAMETERS in software version 1.3

Job #:
Production Order #
Drive Model #:

Drive Serial #:
Test Technician:
Date:

Index

Symbols

Nomenclature 2-8
 .cfg file, iView configuration file 8-20

Numerics

1 = LAN port 2-5
 1 bus, Common bus connections 11-13, 11-14
 110 VDC Bus Connections, iBox 11-13
 120 VAC Bus Connections, iBox 11-13
 15A, Final Limit switch connection 11-14
 15B, Pit/Final Limit switch connection 11-14
 2 = System port 2-5
 2 bus, 120 VAC connections 11-13, 11-14
 2 PI bus, 120 VAC connections 11-13
 3 = PC port 2-5
 3 = PC port connections 2-35
 3 bus, 110 VDC connections 11-13, 11-14
 3 HA bus, 110 VDC connections 11-13

A

A-, Velocity Encoder input 6-112, 11-7
 A+, Velocity Encoder input 6-112, 11-7
 ABD, Hoistway Access Bottom Down switch input 6-114, 11-10
 ABU, Hoistway Access Bottom Up switch input 6-114, 11-10
 AC Drive
 car does not reach high speed 4-11
 description 1-10
 Parameters 4-8, 4-14, 4-28
 parameters 2-47
 TORQMAX Parameters Quick Reference 11-27
 AC supply 5-7
 Acceleration (Command) test point, description 11-3
 Acceleration (Directional) test point, description 11-3
 Acceleration (Filtered) test point, description 11-3
 Acceleration (Interpolated) test point, description 11-3
 Acceleration (Raw) test point, description 11-3
 Acceleration (Slew) test point, description 11-3
 Acceleration parameter 4-12, 9-132
 Acceleration specification 11-2
 accessing online help 8-24
 acquiring write privilege 1-13, 2-30
 Active configuration serial outputs 10-56
 Active configurations, setting 9-99

Active Mode - Balanced output 9-123
 Active Mode - Demand Down Peak output 9-123
 Active Mode - Demand Up Peak output 9-123
 Actual direction 9-9
 Actual Position 9-9
 Actual speed, calibrating 2-57
 ADA Car Call Dwell Time 9-41
 ADA Hall Call Dwell Time 9-41
 ADC, verifying ADC conversion 2-48
 Add a timer 9-136, 10-63
 Adding a circuit board 6-79
 Adjusting
 AC Drive parameters 2-47
 Brake Calibration 2-51
 Brake coordination 4-28
 Brake drop delay 4-26
 Brake parameters 4-20
 Brake picking 2-53, 4-19
 Brake release 4-26
 Brake Resistance 2-22
 Car speed 2-57
 Counterweight Balance 3-29
 Dead zone 4-27
 Emergency slowdown 4-53
 Final Approach 4-15, 4-26
 Following error 2-58
 Leveling speed 4-27
 Load thresholds 4-31
 Load Weigher 4-30, 4-32
 Motor Current Limiting 4-14
 overshoot 4-14
 Overspeed Margins 4-55
 Pattern parameters 4-14
 Pretorque 4-16
 Releveling 4-29
 Ride quality 4-30
 Speed 4-11
 Speed pick delay 4-7
 System 12 Drive 2-48
 Tachometer Error tripping threshold 2-59, 4-41
 Alarm Button input 9-106
 Alarm Buzzer 9-34
 Alarm Buzzer output 9-115
 Alarm Light 9-34
 Alarm Light output 9-115

- Alarm Reset input 9-106
- Allow same floor hall calls to reverse doors on a departing car 10-11
- ALT SPEED PROFILE 1 message 6-13
- ALT SPEED PROFILE 2 message 6-13
- Alternate 1 profile 4-14, 9-128
- Alternate 2 profile 4-14, 9-128
- Alternate Dispatcher selection 10-8
- Alternate Floor Smoke input 9-106
- ALTERNATE FLOOR SMOKE message 6-13
- Alternate Floor Smoke Sensor Recall message 6-13
- Alternate Recall floor, Fire service 9-44
- Alternate Speed Profile 1 Activated message 6-13
- Alternate Speed Profile 1 Deactivated message 6-13
- Alternate Speed Profile 1 input 9-106
- Alternate Speed Profile 1 message 6-13
- Alternate Speed Profile 2 Activated message 6-13
- Alternate Speed Profile 2 Deactivated message 6-13
- Alternate Speed Profile 2 input 9-106
- Alternate Speed Profile 2 message 6-13
- Anti-nuisance 9-38
 - Cancel car calls behind car 9-38
 - Light load 9-38
 - Photo Eye 9-38
- Anti-nuisance controls 4-31
- Approach deceleration parameter 4-13, 9-132
- Approach jerk parameter 4-13, 9-132
- Armature Active Status test point, description 11-3
- Armature Command (Control) test point, description 11-3
- Armature Command (Damped) test point, description 11-3
- Armature Command (Raw) test point, description 11-3
- Armature Composite Control test point, description 11-3
- Armature Control Set test point, description 11-3
- Armature Current 9-9
- Armature Current Dampen Feedback test point, description 11-3
- Armature Current Signal test point, description 11-3
- Armature Current Synthetic Feedback test point, description 11-3
- Armature Differential Command test point, description 11-3
- Armature Differential Gain test point, description 11-3
- Armature Error (Damped) test point, description 11-4
- Armature Error (Raw) test point, description 11-4
- Armature Feedforward (Control) test point, description 11-4
- Armature Feedforward (Raw) test point, description 11-4
- Armature Integral Command test point, description 11-4
- Armature Integral Gain test point, description 11-4
- Armature On Status test point, description 11-4
- Armature Proportional Command test point, description 11-4
- Armature Proportional Gain test point, description 11-4
- Armature Voltage 9-9
- Armature Voltage Dampen Feedback test point, description 11-4
- Armature Voltage Signal test point, description 11-4
- Armature Voltage Synthetic Feedback test point, description 11-4
- Arrival Fixtures, parameters 9-33
- Ascending Car Overspeed Fault message 6-13
- ASCND CAR OVR SPD FLT message 6-13
- ATD, Hoistway Access Top Down switch input 6-114, 11-10

- Attendant Buzzer output 9-115
- Attendant HC Above output 9-115
- Attendant HC Below output 9-115
- Attendant Service Down input 9-106
- Attendant Service Indicator output 9-115
- Attendant Service input 9-106
- Attendant Service message 6-13
- Attendant Service mode 9-5
- Attendant Service Non-Stop input 9-106
- Attendant Service parameters 9-78
- Attendant Service Up input 9-106
- Attendant Svc message 6-13
- ATU, Hoistway Access Top Up switch input 6-114, 11-10
- Auto Stop parameters 9-79
- Automatic 10-71
- Automatic mode, selecting 10-15
- Automatic Stop Input 9-106
- Automatic Stop message 6-13
- Automatic Swing Operation 9-39
- Auto-tuning for induction motors, TORQMAX drive 2-54
- Available for fire service output 9-115
- Average wait times 10-74

B

- B-, Velocity Encoder input 6-112, 11-7
- B+, Velocity Encoder input 6-112, 11-7
- B1, B2, DC power to motor brake 11-14
- Backup Dispatcher, description of 10-4
- Backup Dispatching 10-6-??
- Backup power direction reversal message 6-14
- Backup power recall done output 9-115
- Backup power recall input 9-106
- BACKUP POWER RECALL message 6-14
- Backup power recall OFF message 6-14
- Backup power recall ON message 6-14
- Backup power recall reverse direction input 9-106
- Backup power unit failure activated message 6-14
- Backup power unit failure deactivated message 6-14
- Backup power unit failure input 9-106
- Backup power unit failure message 6-14
- Balanced 10-71
- Balanced Mode message 6-14
- Balanced mode, selecting 10-15
- Balancing the Counterweight 3-29
- BATTERY VLTG LOW-IMP message 6-14
- Battery Voltage Low-IMP message 6-14
- BD, Brake Drive relay indicator 11-12
- BDRD, Brake Drive Redundancy indicator 11-12
- Blocking New Remote Connections message 6-14
- BLOCKING REMOTE UIS message 6-14
- Blue cables 5-12, 5-13
- Brake
 - adjust to control rollback 2-50
 - auto calibration procedure 2-51
 - Brake monitoring 3-20
 - calibration 2-50-??, 9-140
 - calibration procedure 2-50
 - configuration 9-24-9-27
 - Current Reference 9-27

- current, on Operational Status tab 9-10
- Filters 9-25
- iBox connections 11-12
- Output Timer 9-27
- Resistance 2-22
- setup 9-140
- Timers 9-26
- verify picking 2-53
- Voltage 6-16
- voltage, on Operational Status tab 9-10
- voltages 9-25, 9-27
- wiring 2-23
- BRAKE CNT DRV PRF FLT message 6-14
- BRAKE CONT PRF FAULT message 6-15
- Brake Contactor Driver Proofing Fault message 6-14
- Brake Contactor Proofing Fault message 6-15
- Brake Contactor Status test point, description 11-4
- Brake coordination, adjusting for smooth stops 4-28
- Brake Current Feedback test point, description 11-4
- Brake current low pass frequency parameter 9-25
- Brake Current Resistance 2-22
- Brake Current Signal test point, description 11-4
- Brake Drive Redundancy indicator 11-12
- Brake drop delay 9-26
- Brake drop delay, adjusting for final stop 4-26
- BRAKE DROP FAULT message 6-15
- Brake Drop Fault message 6-15
- Brake Enable Fault message 6-15
- Brake Enable Status test point, description 11-4
- Brake Holding Voltage output 9-122
- Brake IGBT Fault, see Excessive Brake Feedback Fault message 6-34
- Brake Module Over Temperature Fault message 6-15
- Brake Output Circuit Failure message 6-16
- BRAKE OUTPUT FAILURE message 6-16
- BRAKE OVER TEMP FAULT message 6-15
- Brake pick delay 9-26
 - adjusting 3-31
- BRAKE PICK FAULT message 6-16
- Brake Pick Fault message 6-16
- Brake Pick Fault Off message 6-16
- Brake release time, adjusting for final stop 4-26
- Brake Switch input 3-20, 9-112
- Brake Triac active indicator 11-12
- BRAKE V NOT ON FAULT message 6-16
- Brake Voltage Feedback test point, description 11-4
- Brake voltage low pass frequency parameter 9-25
- Brake Voltage Not On Fault message 6-16
- Brake Voltage Signal test point, description 11-4
- BRD, Brake Redundancy indicator 11-12
- Bus 2 Fuse Open message 6-16
- Bus 2D Fuse Open message 6-16
- Bus 2MC Fuse Open message 6-17
- Bus 2PI Fuse Open message 6-17
- Bus 3 Fuse Open message 6-17
- Bus 3HA Fuse Open message 6-17
- Bus Enabled 5-26
- Bus Status 5-26
- Bus Voltage 5-26
- Bypass Jumper, using for troubleshooting 6-3

- Bypass status, Fault bypass 9-18
- Bypass Timers
 - Photo Eye 9-31
 - Safe Edge 9-30

C

- Cabinet Installation 2-9
- cables for Velocity Encoder 2-26
- Calibrate Floor offsets 4-23
- Cancel car calls behind car 9-38
- Cancel In-Car CFSS Mode 1 input 9-106
- Cancel In-Car CFSS Mode 2 input 9-106
- Cancel remaining car calls with direction reversal 9-38
- Capture Input 9-106
- Capture Input OFF message 6-17
- Capture Input ON message 6-17
- Capture message 6-17
- Capture mode 9-5
- Capture Mode message 6-17
- Capture Mode switch, iBox control 7-12
- Car at same floor bonus 10-11
- Car Call Audible output 9-115
- Car Call Cancel Button input 9-106
- Car Call Dwell Time 9-41
- Car Call Enable 1 - Front inputs 9-112
- Car Call Enable 1 - Rear inputs 9-112
- Car Call Enable 2 - Front inputs 9-112
- Car Call Enable 2 - Rear inputs 9-112
- Car call enable floor passcodes 10-48
- Car Call Enable Operation 1 (2) Override input 9-106
- Car call enable passenger passcodes 10-49
- Car Call Registered Audible output 9-115
- Car Call Restrictions - elevator security 10-45
- Car Call Security 1 (2) Override outputs 9-115
- Car calls 10-73
- Car Calls - Front COP 1 outputs 9-121
- Car Calls - Front COP 2 outputs 9-121
- Car Calls - Front COP1 inputs 9-111
- Car Calls - Front COP2 inputs 9-111
- Car Calls - Rear COP 1 outputs 9-121
- Car Calls - Rear COP 2 outputs 9-121
- Car Calls - Rear COP1 inputs 9-111
- Car Connections, iBox 6-113, 11-8
- CAR DEL DOORS CLOSED message 6-17
- CAR DEL DOORS CLOSING message 6-17
- CAR DEL DOORS OPEN message 6-18
- CAR DEL DOORS OPENING message 6-18
- CAR DEL DOORS STALLED message 6-18
- CAR DEL DOORS UNKNOWN message 6-18
- Car Delayed output 9-116
- Car delayed timer 9-38
- Car delayed with doors closed message 6-17
- Car delayed with doors closing message 6-17
- Car delayed with doors open message 6-18
- Car delayed with doors opening message 6-18
- Car delayed with doors stalled message 6-18
- Car delayed with unknown door position message 6-18
- car direction, verifying 2-55
- car does not reach high speed 4-11
- Car Door Bypass message 6-18

Car Door Bypass switch, iBox control 7-12
 Car fan and light timer 9-38
 Car Heavy Load - Deactivated message 6-18
 Car Heavy Load Activated - Hall Calls Bypassed message 6-18
 CAR HEAVY LOAD message 6-18
 Car identifier parameter 4-57, 9-95
 Car In Service output 9-116
 Car label parameter 9-95, 10-7
 Car Not Empty Sensor Input 9-107
 Car Operating Panel Connections 3-18
 Car Operation
 Attendant Service 9-78
 Auto Stop 9-79
 CFSS 9-73
 Configuration parameters 9-29–9-85
 Devices 9-33
 diagnostic flags 9-12
 Doors 9-30
 Earthquake 9-64
 Elevator recall 9-61
 Emergency Medical Service 9-66
 Emergency power 9-70
 Fire Service 9-44
 Flood Operation 9-76
 Independent service 9-59
 Passenger 9-37
 Sabbath operation 9-81
 Shuttle service 9-84
 CAR OS DOORS CLOSED message 6-19
 CAR OS DOORS CLOSING message 6-19
 CAR OS DOORS OPEN message 6-19
 CAR OS DOORS OPENING message 6-19
 CAR OS DOORS STALLED message 6-19
 CAR OS DOORS UNKNOWN message 6-19
 Car Out Of Service output 9-116
 Car out of service timer 9-38
 Car out of service unknown door position message 6-19
 Car out of service with doors closed message 6-19
 Car out of service with doors closing message 6-19
 Car out of service with doors open message 6-19
 Car out of service with doors opening message 6-19
 Car out of service with doors stalled message 6-19
 Car Over Load Activated message 6-20
 Car Over Load Deactivated message 6-20
 CAR OVERLOAD message 6-20
 Car Panel (Hoistway) Access Enable switch input 6-113, 11-8
 Car Panel Emergency Stop switch input 6-113, 11-8
 Car Panel Insp message 6-20
 Car Panel Inspection Disabled message 6-20
 Car Panel Inspection Enabled message 6-20
 Car Panel Inspection Inputs OK message 6-20
 Car Panel Inspection message 6-20
 Car Panel Inspection mode 9-5
 Car Panel Inspection Operation message 6-20
 Car Position
 Actual 9-9
 Logical 9-9
 Car Reaction 4-56
 Car shut down due to emergency power operation with no supervisor (Activated) message 6-20
 Car shut down due to emergency power operation with no supervisor (Deactivated) message 6-20
 Car Speed 9-8
 Car Speed specification 11-2
 Car status messages window 9-10
 CAR STOP SWITCH OPEN message 6-21
 Car Stop Switch Open message 6-21
 Car Top, iBox status LED 7-11
 Car/Counterweight Buffer Test 4-46
 Car/Counterweight Safety Test 4-45
 card reader, call enable device 9-112, 9-113, 10-39, 10-56
 Cars, number of parameter 10-7
 CARTOP AUTO UIM FLT message 6-21
 Cartop Automatic Unintended Motion Fault message 6-21
 CARTOP COMM FAULT message 6-21
 Cartop Communication Fault message 6-21
 Cartop Emergency Stop message 6-21
 Cartop Emergency Stop switch 3-17
 Cartop Exit no Counterweight Configuration Error message 6-22
 CARTOP EXIT OPEN message 6-21
 Cartop Exit Open message 6-21
 Cartop Exit Open Off message 6-21
 Cartop Firmware Update Mode message 6-22
 CARTOP FW UPDATE MODE message 6-22
 Cartop Insp message 6-22
 CARTOP INSP UIM FLT message 6-22
 Cartop Inspection Disabled message 6-22
 Cartop inspection DOWN button 3-17
 Cartop Inspection Enabled message 6-22
 Cartop Inspection Inputs OK message 6-22
 Cartop Inspection message 6-22
 Cartop Inspection mode 9-5
 Cartop Inspection Operation message 6-22
 Cartop Inspection output 9-116
 Cartop Inspection Switches 3-17
 Cartop Inspection Unintended Motion Fault message 6-22
 Cartop inspection UP button 3-17
 Cartop Inspection Wiring 2-29
 Cartop interconnections 1-16
 Cartop Link Connections, iBox 6-113, 11-8
 Cartop Position 9-9
 Cartop Power Loss message 6-22
 Cartop Processor Board Quick Reference 6-86
 Cartop Safety Relay 2-27
 Cartop Safety Relay Bypass 2-27, 2-28
 Cartop Safety Switches 2-27
 CC Eligibility Config x input 9-107
 CC Eligibility Config x output 9-116
 Central dispatcher, description of 10-4
 CFSS 1 at floor message 6-22
 CFSS 1 In-car message 6-23
 CFSS 1 recall message 6-23
 CFSS 2 at floor message 6-23
 CFSS 2 In-car message 6-23
 CFSS 2 Recall message 6-23
 CFSS call enable 1 (2), CFSS mode 1 (2) serial inputs 10-57
 CFSS call serial inputs 10-53
 CFSS Calls - CFSS 1 (2) outputs 9-124
 CFSS Car Buzzer 1 (2) outputs 9-116

- CFSS Car Light 1 (2) outputs 9-116
- CFSS In Car Switch 1 input 9-107
- CFSS In Car Switch 2 input 9-107
- CFSS In Use 1 (2) outputs 9-123
- CFSS Mode 1 (2) at Floor mode 9-5
- CFSS Mode 1 (2) In-car mode 9-5
- CFSS Mode 1 (2) In-Use outputs 9-116
- CFSS Mode 1 (2) Recall mode 9-5
- CFSS Mode 1 (2) System outputs 9-116
- CFSS Mode 1 at Floor Activated message 6-22
- CFSS Mode 1 In-car Activated message 6-23
- CFSS Mode 1 Recall Activated message 6-23
- CFSS Mode 2 at Floor Activated message 6-23
- CFSS Mode 2 In-car Activated message 6-23
- CFSS Mode 2 Recall Activated message 6-23
- CFSS operation 10-9
- CFSS Recall 9-74
 - In-car audible indicator 9-74
 - In-car visual indicator 9-74
- CFSS serial outputs 10-53
- CFSS System 1 (2) outputs 9-123
- CFSS tab 10-9
- Changing parameters 2-30
- Check for shorts to ground 2-16
- Checking AC phase 5-7
- Checking the Hoist Motor 2-21
- Circuit board removing & replacing 6-79
- Circuit boards, troubleshooting 6-82–6-122
- CNPB Fault, see Brake Contactor Proofing Fault message 6-15
- CNPBD Fault, see Brake Contactor Driver Proofing Fault message 6-14
- CNPM Fault, see Motor Contactor Proofing Fault message 6-55
- CNPMB Fault, see Motor Contactor Driver Proofing Fault message 6-55
- Cnstr Car Panel Insp message 6-23
- Cnstr Cartop Insp message 6-23
- Cnstr CP Insp message 6-23
- Cnstr CT Insp message 6-23
- Cnstr HA Insp message 6-23
- Cnstr HA Inspection message 6-23
- Cnstr Inspection message 6-23
- Cnstr Mach Room Insp message 6-23
- Cnstr MR Insp message 6-23
- Coincidence call bonus 10-11
- Commanded direction 9-9
- Commandeer For Special Service parameters 9-73–9-75, 10-9
- Commercial Power output 9-116
- Common Bus Connections, iBox 11-13
- Computer IP address, setting 2-35–2-38, 8-6
- Computer Reset, iBox control 7-4
- Computer, iBox status LED 7-11
- Configuration 9-24–9-137, ??–10-64
 - Brake 9-24
 - Car Call Enable 9-28
 - Car Operation 9-29
 - Drive 9-87
 - Floor heights 9-94
 - General tab 9-95
 - I/O Boards 9-100
 - Loadweigher tab 9-126
 - Pattern 9-128
 - Serial I/O 10-51
 - Terminal switches 9-134
- Configuration File 6-80
 - Configuration file
 - creating 8-20
 - editing 8-23
 - loading 8-22
 - saving 8-20
- Configuration File - Generate Default 8-21
- Connected 5-26
- Connection Status 5-26
- Connections 2-35–2-41
 - Direct 2-35
- Construction Car Panel Inspection mode 9-5
- Construction Car Panel Inspection Operation message 6-23
- Construction Cartop Inspection mode 9-5
- Construction Cartop Inspection Operation message 6-23
- Construction Hoistway Access Inspection mode 9-6
- Construction Hoistway Access Inspection Operation message 6-23
- Construction Inspection mode 9-6
- Construction Inspection Operation message 6-23
- Construction Machine Room Inspection mode 9-6
- Construction Machine Room Inspection Operation message 6-23
- Construction Mode 2-1–2-60, ??–2-61, 3-1–3-25
 - exiting 3-25
 - Faults 2-3
 - Overview 2-2
 - Required connections 2-3
- Contactor drop delay 9-26
- Contract Overspeed Test 4-47
- Contract overspeed, Safety parameter 9-148
- Contract speed, Safety parameter 9-148
- Controller Main Computer Startup message 6-23
- Controller Specifications 11-2
- Controller Stop switch, iBox control 7-12
- Controller View 9-1
- Controller view 9-2
- COP, iLink serial connection 3-15
- Correction profile 4-14, 9-128
- Counterweight balancing 9-141
- Counterweight balancing, preparing for final adjustments 3-29
- Counterweight derailment detector 3-21
- Counterweight Derailment output 9-116
- counterweight learn operation 9-141
- Counterweight Learn procedure 3-28
- Counterweight position parameter 9-141
- Coupling rotational ratio 2-45
- CP INSP. DISABLED message 6-20
- Creating a Configuration file 8-20
- creating a direct connection 2-39
- Creating a new LAN connection 8-13
- Cross Registration 10-55
- Cross registration serial inputs 10-55
- Cross registration serial outputs 10-55
- Crosshead Deflection Load Weigher 4-30

- Cross-registration 10-36
- CT INSP. DISABLED message 6-22
- CTEX NO CWI CFG ERROR message 6-22
- Current Limiting 4-14
- Custom Outputs 9-124
- Custom outputs, configuring 9-139

D

- DAC Offset Status test point, description 11-4
- DAC, verifying DAC conversion 2-48
- Data trap 9-11
- Data Trap Triggering Event 9-11
- DCAB, Door Contact Access Bottom input 6-115, 11-11
- DCAT, Door Contact Access Top input 6-115, 11-11
- DCL, Door Close Limit input 6-113, 11-8
- DCMS, Door Contact Main String input 6-115, 11-11
- Dead zone distance parameter 9-130
- Dead zone, adjusting for final stop 4-27
- Deceleration parameter 4-13, 9-132
- Deceleration rate, bunching up of 4-15
- Default IP Addresses 2-34
 - iBox settings 7-9
- default parameter settings, saving 8-21
- Delayed Mechanically In Service output 9-116
- Demand Down Peak 10-71
- Demand Down Peak Mode message 6-24
- Demand Down Peak mode, selecting 10-15
- demand peak detection parameters 10-17
- Demand peak options 10-17
- Demand peak parameters 10-19
- Demand Up Peak 10-71
- Demand Up Peak Mode message 6-24
- Demand Up Peak mode, selecting 10-15
- DETS, Down Emergency Terminal Limit switch input 6-114, 11-9
- Devices configuration 9-33–9-36
- Diagnostic flags
 - Car Operation 9-12
 - Drive 9-12
 - Motion 9-12
 - Safety 9-12
- Diagnostic Outputs window 9-13
- Diagnostics 9-11–9-23
 - Data Trap 9-11
 - Diagnostic Flags 9-12
 - Event Log 9-14
 - Fault Bypass 9-17
 - Terminal Switches Status 9-19
- Direct connections 8-5–8-12
 - connecting 8-11
 - creating 2-39, 8-9
- Direct connections, 3 = PC port 2-35
- Direction arrow down 2 output 9-116
- Direction Arrow Down output 9-116
- Direction arrow up 2 output 9-116
- Direction Arrow Up output 9-116
- Disable Front Hall Door Buttons input 9-110
- Disable Rear Hall Door Buttons input 9-110
- Dispatcher = Car 'n' message 6-24
- Dispatching ??–10-31
 - Configurations tab, Simplex / Swing / Backup Dispatcher 10-12
- Dispatching tab 10-11
- Dispatching, description 1-4
- Display contrast, iBox control 7-4
- DLAB, Door Lock Access Bottom input 6-115, 11-11
- DLAT, Door Lock Access Top input 6-115, 11-11
- DLM, Down Leveling Marker Sensor input 6-113, 11-8
- DLMS, Door Lock Main String input 6-115, 11-11
- DN ETS POSITION FAULT message 6-25
- DN NTSn L1 SPEED FLT message 6-25
- DN NTSn L2 SPEED FLT message 6-26
- DN NTSn POSITION FLT message 6-26
- DNT1, Down Slowdown Limit switch #1 input 6-114, 11-9
- DNT2, Down Slowdown Limit switch #2 input 6-114, 11-9
- DNT3, Down Slowdown Limit switch #3 input 6-114, 11-9
- DNT4, Down Slowdown Limit switch #4 input 6-114, 11-9
- DNT5, Down Slowdown Limit switch #5 input 6-114, 11-9
- DNTD, Down Normal Limit Direction switch input 6-114, 11-9
- docking and undocking windows in iView 8-35
- DOL, Door Open Limit input 6-113, 11-8
- Door Close Protection Timer 9-31
- Door Dwell Timers 9-41
 - ADA Car Call 9-41
 - ADA Hall Call 9-41
 - Car Call 9-41
 - Hall Call 9-41
 - Lobby Call Dwell 9-41
 - Reopen Dwell 9-41
- DOOR LK CLIPPED G200 message 6-24
- DOOR LK CLIPPED L200 message 6-24
- Door Lock Clipped Greater than 200fpm message 6-24
- Door Lock Clipped Less than 200fpm message 6-24
- Door lock indicators 9-10
- DOOR LOCK OPENED message 6-24
- Door Motor Protection Timers
 - Closing 9-31
 - Opening 9-31
- Door Open Button Bypass Timer 9-31
- Door Opening Protection Timer 9-31
- Door operator, preparing for final adjustments 3-28
- Door parameters, verifying 3-24
- Door pre-opening distance parameter 9-129
- Door times 10-22
- Door Zone 3-2
- Door Zone Sensor (DZ) 3-12
- Doors configuration 9-30–9-32
- Doors Locked, iBox status LED 7-11
- DOWN DIR LIMIT OPEN message 6-24
- Down Direction Limit Open message 6-24
- Down Emergency Switch Shutdown message 6-25
- Down Emergency Terminal Switch Position Fault message 6-25
- DOWN ETS SHUTDOWN message 6-25
- Down Level 3-2
- Down Normal Terminal 'n' Level 1 Speed Fault message 6-25
- Down Normal Terminal 'n' Level 2 Speed Fault message 6-26
- Down Normal Terminal 'n' Position Fault message 6-26
- Down switch, iBox control 7-12

- Down, iBox status LED 7-11
- DP1-, Position Encoder input 6-112, 11-7
- DP1+, Position Encoder input 6-112, 11-7
- DP2-, Position Encoder input 6-112, 11-7
- DP2+, Position Encoder input 6-112, 11-7
- DPM, Door Position Monitor input 6-113, 11-8
- Drawing Name 2-7
- Drawing Number Format 2-7
- Drive
 - Filters tab 9-91
 - Safety tab 9-90
- Drive At Speed Fault message 6-26
- Drive Calibration
 - calibrating offsets 9-142
 - Input ADC 9-93
 - Output DAC 9-93
- Drive Communication Fault message 6-26
- Drive Communication Warning message 6-26
- Drive Configuration 9-87–9-93
 - General tab 9-88
 - Pre-Start Sequence parameters 9-88
 - Pre-Torque tab 9-92
- Drive Configuration parameters 9-87–9-93
- Drive Connections, iBox 11-12
- Drive Control parameters 9-92
 - Pre-torque balance adjustment 9-92
 - Pre-torque gain 9-92
 - Pretorque position compensation 9-92
- DRIVE ENABLE FDBK FLT message 6-27
- Drive Enable Feedback Fault message 6-27
- Drive Enable Status test point, description 11-4
- DRIVE FAULT message 6-27
- Drive Fault message 6-27
- Drive Inspection Overspeed Fault message 6-27
- Drive interface parameter 9-88
- DRIVE IOS FAULT message 6-27
- Drive IOS Limit test point, description 11-4
- Drive IOS Param Limit test point, description 11-4
- Drive Offsets calibration parameters
 - Input ADC 9-93
- Drive On Fault message 6-27
- Drive On, iBox status LED 7-11
- Drive Parameters Quick Reference, TORQMAX 11-27
- Drive Ready Fault message 6-28
- Drive Ready On Fault message 6-27
- Drive Start Failure message 6-28
- Drive Type parameter 9-88
- Drive, diagnostic flags 9-12
- Driver VDC 5-26
- DRO fault 4-19
- DRO fault, empty car test 3-31
- Drop delay, adjusting for final stop 4-28
- Dual Channel QUAD Fault message 6-28
- DUAL CHANNEL QUAD FLT message 6-28
- Dynamic parking 10-21, 10-26
- DZ, Door Zone Sensor input 6-113, 11-8

E

- Earthquake (EQ) sensor 3-21
- Earthquake board power supply OFF message 6-28

- Earthquake board power supply ON message 6-28
- Earthquake Board Quick Reference 6-96
- Earthquake Buzzer output 9-117
- Earthquake Code 9-64
- Earthquake Emergency Stop message 6-28
- Earthquake Light output 9-117
- Earthquake Operation (Counterweight) message 6-29
- Earthquake Operation (Seismic Switch) message 6-29
- Earthquake Operation Activated message 6-28
- Earthquake Operation Deactivated message 6-29
- Earthquake parameters 9-64
- Earthquake profile 4-13, 9-128
- Earthquake Reduce Speed message 6-29
- Earthquake reset button OK message 6-29
- Earthquake reset button stuck ON message 6-29
- EARTHQUAKE RUN message 6-29
- Earthquake Run message 6-29
- Earthquake Shutdown message 6-29
- Edit a parameter on the iBox 7-5
- Edit a parameter using iView 8-18
- Editing a configuration file 8-23
- Editing displays 8-39
- EEPROM Device Error message 6-29
- Egress floor 9-37
- Egress Floor Gong output 9-117
- Electrical Governor Test 4-46
- Elevator code compliance 1-3
- Elevator Recall Operation (Switch 'n') message 6-30
- Elevator recall parameters 9-61
- ELEVATOR RECALL SW'n' message 6-30
- EM BK UIM RESET STUCK message 6-31
- EMCO Load Weigher Installation 5-53
- EMERG ALARM ACTIVATED message 6-30
- EMERG BRAK LEG 2 SHORT message 6-31
- EMERG BRAKE OK OPEN message 6-31
- EMERG BRAKE TRIPPED message 6-31
- EMERG BRK LEG 1 SHORT message 6-31
- EMERG POWER RECALL message 6-33
- EMERG POWER RUN message 6-33
- EMERG POWER SHUTDOWN message 6-33
- EMERG PWR NO COMM message 6-33
- Emerg. Pwr. Car Selected to Recall output 9-117
- Emerg. Pwr. Car Selected to Run output 9-117
- Emergency Alarm Acknowledged message 6-30
- Emergency Alarm Activated (Alarm button) message 6-30
- Emergency Alarm Activated (Car delayed with doors closed) message 6-30
- Emergency Alarm Activated (In-car stop switch) message 6-30
- Emergency Alarm Activated (Safety opened) message 6-30
- Emergency Alarm Activated message 6-30
- Emergency Alarm Deactivated without Acknowledgment message 6-31
- Emergency Alarm Monitoring 9-34
- Emergency Brake Board Quick Reference 6-92
- Emergency Brake Leg 1 Short Fault message 6-31
- Emergency Brake Leg 2 Short Fault message 6-31
- Emergency Brake OK open message 6-31
- Emergency Brake OK open Off message 6-31
- Emergency Brake Test - Unintended Motion 4-49

Emergency Brake Test - Unintended Motion for Machine Brake 4-49
 Emergency Brake Test - Unintended Motion for Rope Gripper 4-48
 Emergency Brake Tripped message 6-31
 Emergency Brake UIM Reset Button Stuck message 6-31
 Emergency Dispatch input 9-107
 Emergency Dispatch message 6-31
 Emergency Dispatch Off message 6-31
 Emergency Dispatch Override input 9-107
 Emergency Exit contact 3-17
 Emergency Medical Service Bypassed message 6-32
 Emergency Medical Service Deactivated message 6-32
 Emergency Medical Service In-Car Activated (Switch 'n') message 6-32
 Emergency Medical Service parameters 9-66–9-69
 Emergency Medical Service Recall Activated (Switch 'n') message 6-32
 Emergency power 5-26, 10-33
 Emergency Power Activated message 6-32
 Emergency Power and no communication with group message 6-33
 Emergency Power Auto Car Select input 9-107
 Emergency Power Auto Recall input 9-107
 Emergency Power Car Done Recall output 9-117
 Emergency Power Deactivated message 6-33
 Emergency Power input 9-107
 Emergency power input 9-70
 Emergency Power Manual Car Select input 9-107
 Emergency Power Manual Override input 9-107
 Emergency Power parameters 9-70–9-72
 Emergency Power Permission to Run input 9-107
 Emergency Power Phase I output 9-117
 Emergency Power Phase II output 9-117
 Emergency Power Priority Status output 9-117
 Emergency power profile 4-13, 9-128
 Emergency Power Recall 10-34
 Emergency Power Recall message 6-33
 Emergency Power Return input 9-107
 Emergency Power Run 10-35
 Emergency Power Run message 6-33
 Emergency Power serial inputs 10-54
 Emergency Power serial outputs 10-54
 Emergency Power Service output 9-117
 Emergency Power Shutdown message 6-33
 Emergency rate limited stop parameter 9-89
 Emergency slowdown profile 4-13, 4-53, 9-128
 Emergency Stop switch 2-28
 Emergency Terminal Limit (ETS) 4-9, 9-20
 Emergency Terminal Overspeed 4-55
 Emergency Terminal Switch Overspeed Tests 4-54
 Empty Car Output 9-117
 Empty Car Tests, preparing for final adjustments 3-31
 Empty load detection 4-30
 Empty load input 9-108
 Empty Load output 9-117
 Empty load threshold 4-31, 4-33
 EMS Car Buzzer output 9-117
 EMS Car Light output 9-117
 EMS Car Switch input 9-107
 EMS Hall Light 1 (2) outputs 9-117
 EMS Hall Switch 1 input 9-107
 EMS Hall Switch 2 input 9-108
 EMS In-car (Switch 'n') message 6-32
 EMS In-car (Switch 1) mode 9-6
 EMS In-car (Switch 2) mode 9-6
 EMS Recall (Switch 'n') message 6-32
 EMS Recall (Switch 1) mode 9-6
 EMS Recall (Switch 2) mode 9-6
 Enable switch, iBox control 7-12
 Encoder Signal test point, description 11-4
 Encoder. See also Velocity Encoder
 Entry Keypad 1-8
 Environmental Considerations 2-4
 Environmental Limits specification 11-2
 EP Car Selected to Run or Recall output 9-118
 EPI input 10-34
 EQ board, Earthquake sensor 3-21
 EQ Reset 3-21
 Equipment Location 2-4
 ESC, Car Panel Emergency Stop switch input 6-113, 11-8
 ETA 10-71
 Ethernet 1-4, 5-15
 Ethernet address verification, iBox 7-10
 Ethernet Addresses 2-32, 5-16
 Ethernet addresses 5-14
 Ethernet addresses, on the iBox 9-125
 Ethernet connections 2-5
 Event Log
 Event Filter 9-16
 open a saved file 9-14
 save to file 9-14
 View Event properties 9-15
 viewing on iView 9-14
 viewing on the iBox 7-8
 Event Properties dialog 9-15
 EXCESS BRAKE FDBK FLT message 6-34
 EXCESS MF FDBK FAULT message 6-34
 EXCESS RELEVELS FAULT message 6-34
 EXCESS RESTARTS FAULT message 6-34
 Excessive Brake Feedback Fault message 6-34
 EXCESSIVE FAULTS message 6-34
 Excessive Faults Shutdown message 6-34
 Excessive Motor Field Feedback Fault message 6-34
 Excessive Motor Noise 4-15
 Excessive Relevels Fault message 6-34
 Excessive Restarts Fault message 6-34
 Excessive Restarts Warning message 6-35
 Exercise Operation 9-39
 Exercise Operation Activated message 6-35
 Exercise Operation Deactivated message 6-35
 EXERCISE OPERATION message 6-35
 exiting Construction Mode 3-25

F

F DPM OPEN-GS CLOSED message 6-40
 F DR CLS FLT REC FAIL message 6-38
 F1 help, accessing online help 8-24
 Fan and Light Indicator output 9-118

- Fault Bypass 9-17
- FAULT BYPASS SW ON message 6-35
- Fault Bypass Switch On message 6-35
- Fault Bypass Switch Timed Out Fault message 6-35
- Fault Bypasses 9-18
- Fault messages window 9-10
- Fault Reset, iBox control 7-4
- Fault, iBox status LED 7-11
- Fault/Function Bypass switch, iBox control 7-12
- Field Active Status test point, description 11-4
- Field Command (Control) test point, description 11-4
- field connections 11-7–11-13
- Field Control Path test point, description 11-4
- Field current 9-10
- Field Current Feedback test point, description 11-4
- Field Current Signal test point, description 11-4
- Field Error test point, description 11-4
- Field Integral Command test point, description 11-4
- Field Integral Gain test point, description 11-4
- Field Module Logic Board Quick Reference 6-93
- Field Module Over Temperature Fault message 6-35
- FIELD MODULE OVR TEMP message 6-35
- Field Proportional Command test point, description 11-4
- Field Proportional Gain test point, description 11-4
- Field voltage 9-10
- Field Voltage Feedback test point, description 11-4
- Field Voltage Signal test point, description 11-4
- Field wiring 2-9
- Filters, Drive - Filters tab 9-91
- Final Approach to Floor 4-15
- Fire Code parameters 9-46
- Fire I Light output 9-118
- Fire II Light output 9-118
- Fire Phase II Call Cancel Switch input 9-108
- Fire Phase II Hold Conditions 9-53
- Fire Phase II Recall Conditions 9-52
- Fire Phase II Switch HOLD input 9-108
- Fire Phase II Switch OFF input 9-108
- Fire Phase II Switch ON input 9-108
- Fire Phase II Switch START input 9-108
- Fire Recall Alt. message 6-36
- Fire Recall Alternate message 6-36
- Fire Recall Door Open Main input 9-108
- Fire Recall Main message 6-36
- Fire Recall output 9-118
- Fire Service
 - Alternate Recall floor 9-44
 - Main Recall floor 9-44
 - parameters 9-44–9-58
- Fire Service In-car Activated message 6-35
- Fire Service In-Car Deactivated message 6-36
- Fire Service In-car Hold Operation message 6-36
- Fire Service In-car message 6-35
- Fire Service In-car mode 9-6
- Fire Service In-car Recall Operation message 6-36
- Fire Service operation 9-44
- Fire Service Override 9-46
- Fire Service Phase I Return Complete output 9-118
- Fire Service Recall Alternate message 6-36
- Fire Service Recall Alternate mode 9-6
- Fire Service Recall Deactivated message 6-36
- Fire Service Recall Main message 6-36
- Fire Service Recall Main mode 9-6
- Fire Svc In-car message 6-35
- Fire Switch Settings 9-49
- Fire Warning Buzzer output 9-118
- Fire Warning Light output 9-118
- Firefighter's Panel Unlock output 9-118
- Firmware Update screen 9-155
- Flare jerk parameter 4-13, 9-132
- Flare pattern frequency parameter 9-91
- Flood Operation Activated message 6-36
- Flood Operation Buzzer output 9-118
- Flood Operation Deactivated message 6-36
- Flood Operation Input 9-108
- FLOOD OPERATION message 6-36
- Flood operation parameters 9-76
- Flood Operation Status output 9-118
- Floor Data Settings 9-96
- Floor Data Tab 9-96
- Floor Heat Detectors Activated message 6-37
- Floor Heat Detectors Deactivated message 6-37
- FLOOR HEAT DETECTORS message 6-37
- Floor Heights
 - Learn procedure 4-2
 - Learn tab 9-143
 - Learning the 4-2
- Floor Heights Configuration parameters 9-94
- Floor label parameter 10-7
- Floor Level Sensor Adjustment 3-11
- Floor Leveling Accuracy specification 11-2
- Floor Location Fault message 6-37
- Floor Offset Distance parameter 3-2
- Floor offsets, calibrating 4-23, 9-145
- Floor Override Input 9-108
- Floor Sensor Fault message 6-37
- Floor Sub-Address or Call "Type" Jumper 5-33
- Floor Synchronization 9-130
- Floor Synchronization Fault message 6-38
- Floors, number of parameter 10-7
- FLT BYP SW TIMED OUT message 6-35
- Flux vector technology 1-10
- Following error 2-45
- Following error, calibrating 2-58
- Front (Rear) Disable Hall Door Buttons output 9-120
- Front (Rear) Door Car Gong output 9-120
- Front (Rear) Door Close Limit output 9-120
- Front (Rear) Door Closing Warning Buzzer output 9-120
- Front (Rear) Door Disable Automatic Close output 9-120
- Front (Rear) Door Enable output 9-120
- Front (Rear) Door Hold End output 9-120
- Front (Rear) Door Hold Function output 9-120
- Front (Rear) Door Left Open output 9-120
- Front (Rear) Door Lock Power output 9-120
- Front (Rear) Door This Car Up output 9-121
- Front (Rear) Down Car Lantern output 9-120
- Front (Rear) Nudging Audible output 9-121
- Front (Rear) Up Car Lantern output 9-121
- Front Auxiliary Door Close Button input 9-110
- Front Constant Pressure Close (Front Door) input 9-110
- Front Constant Pressure Open (Front Door) input 9-110

Front COP2 Door Close Button input 9-110
 Front COP2 Door Hold Button input 9-110
 Front COP2 Door Open Button input 9-110
 Front COP2 Door Stop Button input 9-110
 FRONT DOB BYPASSED message 6-39
 Front Door Close Button (COP1) input 9-110
 Front Door Close Fault message 6-38
 Front Door Close Fault Recovery Failure message 6-38
 FRONT DOOR CLOSE FLT message 6-38
 Front Door Close Time-out message 6-38
 FRONT DOOR CNTCT FLT message 6-39
 Front Door Contact Fault message 6-39
 Front Door Hold Button (COP1) input 9-110
 Front Door Open Button (COP1) input 9-110
 Front Door Open Button Bypassed message 6-39
 Front Door Open Fault message 6-39
 Front Door Open Time-out message 6-39
 Front Door Stop Button (COP1) input 9-110
 FRONT DOORS STOPPED message 6-39
 Front Doors Stopped message 6-39
 Front DPM Open - GS Closed message 6-40
 FRONT HALL DOB BYP message 6-40
 Front Hall Door Close Button input 9-110
 Front Hall Door Hold Button input 9-110
 Front Hall Door Open Button Bypassed message 6-40
 Front hall door open button input 9-110
 Front Hall Door Stop Button input 9-110
 Front Momentary Pressure Close (Front Door) input 9-110
 Front Momentary Pressure Open (Front Door) input 9-110
 FRONT PHOTO EYE BYP message 6-40
 Front Photo Eye Bypassed message 6-40
 Front Photo Eye Cut Out input 9-110
 FRONT PHOTO EYE FAIL message 6-40
 Front Photo Eye Failure message 6-40
 FRONT SAFE EDGE BYP message 6-40
 Front Safe Edge Bypassed message 6-40
 FRONT SAFE EDGE FAIL message 6-40
 Front Safe Edge Failure message 6-40
 Fuses 2-16, 5-7
 Fuses on the iBox 7-13

G

Gate release Solenoid output 9-118
 Gateway 7-9, 8-4
 Gear Reduction Ration
 calculating 2-57
 General Configuration parameters 9-95–9-99
 Active configuration settings 9-99
 Car call eligibility 9-97
 Car identifier 9-95
 Car label 9-95
 Floor Data tab 9-96
 Group identifier 9-95
 Simplex car 9-95
 General serial outputs 10-56
 Generate default configuration file 8-21
 Global Parameter Update, Reset Controller message 6-41
 Gong Enable Down Front output 9-118
 Gong Enable Down Rear output 9-118

Gong Enable Up Front output 9-118
 Gong Enable Up Rear output 9-118
 GOV SPEED SWITCH FLT message 6-41
 GOV, Governor input 6-115, 11-11
 GOVERNOR OPEN message 6-41
 Governor open message 6-41
 Governor Speed Reduction Switch Fault message 6-41
 Governor Speed Reduction Switch input 9-112
 Grounding 2-14
 Group Communication Established message 6-41
 Group Communication Lost message 6-41
 Group ID 5-25
 Group identifier parameter 9-95
 Group Info 5-25
 GS, Gate Switch input 6-115, 11-11

H

HA INSP. DISABLED message 6-42
 Hall call addresses 5-33
 HALL CALL BUS 'n' FAIL message 6-41
 Hall Call Bus 'n' Failure message 6-41
 HALL CALL BYPASS INP. message 6-41
 Hall Call Bypass Input 9-108
 Hall Call Bypass Input OFF message 6-41
 Hall Call Bypass Input ON message 6-41
 Hall Call Cross Registration 10-36
 Hall Call Driver Testing 5-43
 Hall Call Eligibility 10-13
 Hall Call Eligibility Config inputs 9-112
 Hall Call Eligibility Config outputs 9-123
 Hall call enable 1 (or 2) serial inputs 10-56
 Hall call enable inputs 9-113
 Hall call enclosures 5-33
 Hall call jumpers 5-33
 Hall Call Restrictions 10-42
 Hall Call Security 1 Override input 9-112
 Hall Call Security 2 Override input 9-112
 Hall Call serial inputs 10-53
 Hall Call Service Disabled message 6-41
 Hall Call Service Enabled message 6-42
 Hall call wiring 5-32
 Hall Calls - Aux outputs 9-123
 Hall Calls - Main outputs 9-123
 Hall Calls inputs 9-112
 Hall gongs - Front outputs 9-122
 Hall gongs - Rear outputs 9-122
 Hall lanterns - Front down outputs 9-122
 Hall lanterns - Front up outputs 9-122
 Hall lanterns - Rear down outputs 9-122
 Hall lanterns - Rear up outputs 9-122
 Heat Detectors inputs 9-115
 Heat Detectors operation 9-86
 Heat Detectors outputs 9-124
 Heat Detectors Recall Activated message 6-42
 Heat Detectors Recall Complete message 6-42
 Heat Detectors Recall Deactivated message 6-42
 HEAT DETECTORS RECALL message 6-42
 Heat Sensor Fault 'n' message 6-42
 Heavy Load Input input 9-108

- Heavy Load output 9-118
- Heavy load threshold 4-31, 4-32, 9-127
- Heavy load, hall call bypass 4-30
- Help, accessing online help 8-24
- High Current 5-26
- High roll jerk parameter 4-12, 9-132
- High speed parameter 4-13, 9-132
- HOIST HEAT DETECTORS message 6-43
- Hoist motor insulation testing 2-21
- Hoistway Access Bottom Down switch input 6-114, 11-10
- Hoistway Access Bottom Up switch input 6-114, 11-10
- Hoistway Access Disabled message 6-42
- Hoistway Access Enabled 6-42
- Hoistway Access Inspection Operation message 6-42
- Hoistway Access message 6-42
- Hoistway Access mode 9-6
- Hoistway Access Operation message 6-42
- Hoistway Access Top Down switch input 6-114, 11-10
- Hoistway Access Top Up switch input 6-114, 11-10
- HOISTWAY DOOR BYPASS message 6-42
- Hoistway Door Bypass message 6-42
- Hoistway Door Bypass switch, iBox control 7-13
- Hoistway Heat Detectors Activated message 6-43
- Hoistway Heat Detectors Deactivated message 6-43
- Hoistway Inspection output 9-118
- HOISTWAY LEARN ON message 6-43
- Hoistway Limit Switches 3-19
- Hoistway Safety Switches 2-28
- Hoistway window 9-4
- Hold delay 9-26
- Hold voltage 2-53, 9-25

I

- I/O Board Configuration 9-100–9-123
 - Adding a Circuit Board 9-101
 - Assign inputs/outputs 9-101
 - Serial COP boards 9-103
- iBox 7-1–7-13
 - configuring IP addresses using iView 9-125
 - control switches 7-12
 - description 1-7, 7-1
 - display menu tree 7-6
 - Event Log messages 6-4
 - front panel controls 7-2
 - fuses 7-13
 - keypad controls 7-4
 - LCD display 1-8, 7-3
 - LCD display, top line characters 7-4
 - messages cross-reference 6-4
 - replacing 6-80
 - Safety bypass jumper 7-13
 - setting and verifying the IP address 7-10
 - status LEDs 7-11
 - status messages 7-12
 - view and set parameters 7-5
 - View/register calls 7-8
 - viewing factory data 7-8
 - viewing MAC addresses 7-8
 - viewing serial numbers 7-8
 - viewing the Event log 7-8
 - viewing version info 7-8
- iBox field connections 11-7–11-13
- ICE-COP Board Diagnostics 6-4
- ICE-COP Board Mounting Template 5-52
- ICE-COP Serial Car Operating Panel Board Quick Reference 6-83
- ICE-CTP Cartop Processor Board
 - diagnostics 6-89
 - Quick Reference 6-86
- ICE-EB Emergency Brake Board Quick Reference 6-92
- ICE-FML Field Module Logic Board Quick Reference 6-93
- ICE-IEQ Earthquake Board Quick Reference 6-96
- ICE-IMP Main Processor Board Quick Reference 6-98
- ICE-IRB Relay Board Quick Reference 6-100
- ICE-IRD Rear Door Board Quick Reference 6-103
- ICE-MIAC Multiple Input AC Board Quick Reference 6-104
- ICE-MOR Multiple Output Relay Board Quick Reference 6-107
- iCentral 1-19
- ICE-RG Rope Gripper Board Quick Reference 6-109
- ICE-SAF Safety Board Quick Reference 6-111
- ICE-SF Serial Fixtures Board Quick Reference 6-116
- iControl
 - cartop communication 1-18
 - cartop interconnections 1-16
 - central monitoring 1-21
 - description 1-1, 1-5
 - dispatching interconnections 1-19
 - layout 1-5
 - load weighing 1-23
 - logging and report generating 1-22
 - system interconnections 1-15
- iControl AC Specifications 11-2
- iControl messages 6-13–6-78, ??–6-78
- iControl wiring connections 2-11
- iControllers 5-11
- ICPD, COP Inspection Station DN Button input 6-113, 11-8
- ICPU, COP Inspection Station UP Button input 6-113, 11-8
- ICTD, Cartop Inspection Down Button 3-17
- ICTD, Cartop Inspection Station DN Button input 6-113, 11-8
- ICTU, Cartop Inspection Station UP Button input 6-113, 11-8
- ICTU, Cartop Inspection Up Button 3-17
- iCue 5-25
 - Capabilities 5-3
 - Dedicated 5-12
- iCue dispatching, description 1-4
- iCue GUI 5-25, 5-27
- iCue, description 1-1
- Idle Swing Car Timer 9-39
- iLand Cable Connections 3-11
- iLand Landing System 1-17–??, 3-2–3-12
 - accuracy 3-2
 - adjustments 3-7
 - cartop mounting 3-3
 - connections 3-11
 - description 1-1, 1-17, 3-2
 - installation instructions 3-5
 - installing floor leveling magnets 3-9, 3-10
 - iView parameter setting 3-12
 - magnet positioning 3-6

- pedestal fabrication and mounting 3-4
- Status LEDs 3-12
- iLand Mounting on Pedestal 3-4
- iLand Pedestal 3-3
- iLand Status LEDs 3-12
- iLink Cartop Box 3-13–3-19
 - car operating panel connections 3-18
 - description 1-1
 - description of communication 1-18
 - diagnostics 6-89
 - enclosure 3-14
 - installation 3-13–3-19
 - power connections 3-18
 - serial connection to iControl 3-17
 - troubleshooting 6-89
- iMonitor, description 1-1, 1-21
- IMP SW FAULT
 - EM STOP message 6-43
 - FLT BYP message 6-43
 - INSP DN message 6-44
 - INSP EN message 6-44
 - INSP message 6-44
 - LEARN message 6-44
 - TEST message 6-44
- IMP SW FLT
 - C DOOR BP message 6-43
 - H DOOR BP message 6-43
 - WRITE EN message 6-44
- IMP Switch Fault - Car Door Bypass message 6-43
- IMP Switch Fault - Emergency Stop message 6-43
- IMP Switch Fault - Fault Bypass message 6-43
- IMP Switch Fault - H. Door Bypass message 6-43
- IMP Switch Fault - Inspection DOWN message 6-44
- IMP Switch Fault - Inspection Enable message 6-44
- IMP Switch Fault - Inspection message 6-44
- IMP Switch Fault - Inspection UP message 6-44
- IMP Switch Fault - LEARN message 6-44
- IMP Switch Fault - None message 6-44
- IMP Switch Fault - Write Enable message 6-44
- In Group, iBox status LED 7-11
- INA, Car Panel (Hoistway) Access Enable switch input 6-113, 11-8
- In-car CFSS Operation 9-75
- In-Car Fire Door Operation output 9-119
- In-Car Fire Hold output 9-119
- In-Car Fire Recall output 9-119
- In-Car Inspection output 9-119
- INCP, COP Inspection Station INSP/AUTO Switch input 6-113, 11-8
- INCT, Cartop Inspection Station INSP/AUTO Switch input 6-113, 11-8
- INCT, Inspection Cartop Enable switch input 2-29, 3-17
- Independent Service Indicator output 9-119
- Independent Service input 9-108
- Independent service message 6-44
- Independent Service mode 9-7
- Independent service parameters 9-59
- Independent Svc message 6-44
- Initial jerk parameter 4-12, 9-132
- initial parameter settings 2-43
- initial power up 2-19
- Input ADC 9-93
- Input/Output assignment 2-13
- Inputs and Outputs
 - terminals 2-13
 - wiring 2-12
- Inputs, programming 9-106
- INSFCNT BRK FDBK FLT message 6-45
- INSFCNT MF FDBK FLT message 6-45
- INSFCNT MF FORCNG FLT message 6-45
- Inspection message 6-45
- Inspection mode 2-19, 3-1–3-31, 9-7
- Inspection operation
 - checking cartop operation 2-61
- Inspection Operation message 6-45
- Inspection Output 9-119
- Inspection Overspeed Fault message 6-45
- Inspection Overspeed Test 4-47
- Inspection overspeed, Safety parameter 9-148
- Inspection profile 4-14, 9-128
- Inspection switch, iBox control 7-12
- Inspection, iBox status LED 7-11
- Install Cabinet 2-9
- Installation
 - tools and test equipment 2-6
- Installing Floor Magnets 3-9
- Installing the Velocity encoder 2-24
- Insufficient Brake Current Feedback Fault message 6-45
- Insufficient Motor Field Feedback Fault message 6-45
- Insufficient Motor Field Forcing Feedback Fault message 6-45
- Insulation test 2-21
- INV CNFG INPUT DCMS R message 6-46
- INV CNFG INPUT DLMS R message 6-47
- INV CNFG INPUT DPM_R message 6-47
- INV INVTRY XCHK BALRQ message 6-48
- INV INVTRY XCHK DCCOR message 6-48
- INV INVTRY XCHK NMS R message 6-48
- INV INVTRY XCHK RD BD message 6-49
- INV INVTRY XCHK RDOPT message 6-49
- INV INVTRY XCHK RG BD message 6-49
- INV INVTRY XCHK RGOPT message 6-50
- INV INVTRY XCHK TALRQ message 6-50
- INVALID CNFG BALRQ message 6-45
- INVALID CNFG INPUT message 6-46
- INVALID CNFG TALRQ message 6-48
- Invalid Configuration BALRQ message 6-45
- Invalid Configuration Input CTEX message 6-46
- Invalid Configuration Input DCAB message 6-46
- Invalid Configuration Input DCAT message 6-46
- Invalid Configuration Input DCMS message 6-46
- Invalid Configuration Input DCMS R message 6-46
- Invalid Configuration Input DLAB message 6-47
- Invalid Configuration Input DLAT message 6-47
- Invalid Configuration Input DLMS message 6-47
- Invalid Configuration Input DLMS R message 6-47
- Invalid Configuration Input DPM message 6-47
- Invalid Configuration Input DPM_R message 6-47
- Invalid Configuration Input message 6-46
- Invalid Configuration Input Off message 6-46

- Invalid Configuration Inventory Cross Check BALRQ message 6-48
- Invalid Configuration Inventory Cross Check DCCOR message 6-48
- Invalid Configuration Inventory Cross Check NMS R message 6-48
- Invalid Configuration Inventory Cross Check RD Board message 6-49
- Invalid Configuration Inventory Cross Check RDOPT message 6-49
- Invalid Configuration Inventory Cross Check RG Board message 6-49
- Invalid Configuration Inventory Cross Check RGOPT message 6-50
- Invalid Configuration Inventory Cross Check TALRQ message 6-50
- Invalid Configuration TALRQ message 6-48
- Invalid Destination, INVALID DESTINATION message 6-50
- Invalid Front Door Position message 6-50
- Invalid Input message 6-50
- Invalid Rear Door Position message 6-51
- INVLD CNFG INPUT CTEX message 6-46
- INVLD CNFG INPUT DCAB message 6-46
- INVLD CNFG INPUT DCAT message 6-46
- INVLD CNFG INPUT DCMS message 6-46
- INVLD CNFG INPUT DLAB message 6-47
- INVLD CNFG INPUT DLAT message 6-47
- INVLD CNFG INPUT DLMS message 6-47
- INVLD CNFG INPUT DPM message 6-47
- INVLD FRONT DOOR PSTN message 6-50
- INVLD REAR DOOR PSTN message 6-51
- IO Map Compare Fault message 6-51
- IO Map Compare Fault Off message 6-51
- IO Map Compare Long Term Fault message 6-51
- IO MAP COMPARE LT FLT message 6-51
- IO Map Toggle Compare Fault message 6-51
- IO Map Toggle Compare Fault Off message 6-51
- IO MAP TOGGLE COMP FLT message 6-51
- IP Address
 - #1 5-15
 - #2 5-15
 - #3 5-15
- IP address
 - setting on iView 2-35–2-38
- IP address, setting and verifying on the ibox 7-10
- iReport, description of 1-1, 1-22
- Isolated Platform Load Weigher 4-31, 5-63
- Isolation transformer, grounding 2-15
- iSystem Overview 1-2
- iView 8-1–8-40
 - configuration tabs 8-25, 8-31
 - connections 1-11, 2-30
 - creating a configuration file 8-20
 - description 1-1, 8-2
 - diagnostic tabs 8-25, 8-31
 - docking and undocking windows 8-35
 - editing the virtual oscilloscope display 8-39
 - installing 8-3
 - Layouts 8-30
 - pinning and unpinning windows 8-33
 - printing screens 8-38
 - programming 1-11
 - resizing windows 8-34
 - saving parameters to a configuration file 8-20
 - Send command 8-19
 - sending parameters to the controller 8-19
 - setting parameters 8-18
 - setting the system's date and time 8-38
 - setup tabs 8-25
 - View menu contents 8-26
 - windows and tabs 8-25
 - working offline 8-23
 - working online 8-17
- iView Logged Off message 6-51
- iView Logged On message 6-51
- iView Lost Connection message 6-51
- iView Status Bar 9-3
- iView Timed Out message 6-51
- iView windows and tabs 9-1–9-125

J

- Jerk specification 11-2
- Job name parameter 10-7
- Job prints 2-7, 5-12, 5-47, 6-107, 6-120

K

- Keypad controls, iBox 7-4
- keypad, call enable device 9-112, 9-113, 10-56

L

- LAN connections 2-30, 8-13–8-16
 - connecting 8-15
 - creating 8-13
 - deleting 8-16
 - editing 8-16
- LAND SYS SENSOR FAULT message 6-52
- Landing system 1-1
 - See iLand Landing System
 - Verifying position encoder resolution 3-27
- Landing System Sensor Fault message 6-52
- Latch First Smoke Detector Zone 9-48
- Latch Primary Fire Recall Switch 9-47
- Latch Secondary Fire Recall Switch 9-48
- Latch the fire hat flashing 9-45
- Layouts, iView screen layouts 8-30
- LCD display, iBox 1-8, 7-3, 7-4
- LCD Fault message 6-52
- LEARN SW TIMED OUT message 6-52
- Learn Switch Timed Out Fault message 6-52
- Learn switch, iBox control 7-12
- Learn U/DNT1-5 and U/DETS Positions message 6-52
- Learn U/DNT1-5 and U/DETS Speeds message 6-52
- LEARN U/DTS POSITIONS message 6-52
- LEARN U/DTS SPEEDS message 6-52
- LEARNING EMPTY LOAD message 6-52
- Learning empty load values message 6-52
- LEARNING FULL LOAD message 6-52
- Learning full load values message 6-52
- Learning the

- Building floor heights 4-2
- Counterweight 3-28
- Empty and loaded car weights 4-33
- ETS and NTS Limit Switches 4-9
- Load Weights 4-30
- Load weights 9-146
- Learning the Safety Configuration 2-46
- Level Down Sensor 3-12, 4-5
- Level Up Sensor 4-5
- Leveling Accuracy specification 11-2
- Leveling distance parameter 4-13, 9-130
- Leveling Overspeed Test 4-48
- Leveling overspeed, Safety parameter 9-148
- Leveling sensor indicators 9-10
- Leveling speed parameter 4-13, 9-130
- Leveling speed, adjusting for final stop 4-27
- Light load anti-nuisance 4-30, 9-38
- Light Load Antinuisance message 6-53
- Light Load Input input 9-108
- Light Load output 9-119
- Light load threshold 4-31, 4-33, 9-127
- LIMIT SW CHKSUM FAULT message 6-53
- LIMIT SW LEARN FAULT message 6-53
- Limit Switches Checksum Fault message 6-53
- Limit Switches Learn Fault message 6-53
- Load calibration on message 6-53
- Load learn process activated message 6-53
- Load learn process deactivated message 6-53
- Load Weigher 1-23
 - Cross Head Deflection 1-23, 9-127
 - installing 3-19
 - Isolated Platform 1-23, 9-127
 - Rope tension sensing 9-127
- Load weigher
 - Crosshead deflection 4-30
 - Empty load threshold 4-31
 - Heavy load threshold 4-31
 - Isolated platform 4-31
 - Light load threshold 4-31
 - Overload threshold 4-31
 - Rope tension 4-30
- Load Weigher (Raw) test point, description 11-4
- Load Weigher Adjustment 4-30
- Load Weigher Balanced test point, description 11-5
- Load Weigher Feedback test point, description 11-5
- Load weigher installation
 - EMCO Load Weigher 5-53
- load weigher learn procedure 9-146
- Load Weigher parameters 9-126
 - Analog Device Configuration 9-127
 - Heavy load threshold 9-127
 - Light load threshold 9-127
 - Load Weighing Device Type 9-126
 - Over Load Threshold 9-127
- Load Weigher Sensor Adjustment 4-16
- Load Weigher Signal test point, description 11-4
- Load Weigher. See also MCE Load Weigher
- Loading parameters from a Configuration file 8-22
- Lobby Call Dwell Time 9-41
- Lobby floor 9-37

- Lobby parking delay 10-21
- Lobby peak 10-71
- Lobby peak detection parameters 10-15
- Lobby Peak Mode message 6-53
- Lobby peak mode, selecting 10-15
- Lobby peak options 10-16
- Lobby peak parameters 10-18
- Lobby Shuffle delay 10-21
- Local Area Network 8-13
- Local car, description of 10-4
- Local Dispatcher, description of 10-4
- Local Dispatching 10-6-??
- Locked, Security status 10-42, 10-45
- Locks/Contacts Connections, iBox 6-115, 11-11
- Logical Position 9-9
- LOSS OF POS/SPD IND message 6-53
- Loss of Position or Speed Indicators message 6-53
- Low roll jerk parameter 4-13, 9-132
- Low speed parameter 9-132

M

- MAC ADDRESS ERROR message 6-54
- Mac Address Error message 6-54
- MAC addresses 9-125
 - viewing on iBox 7-8
- Mach Rm Insp message 6-54
- Machine mode 9-9
- Machine Rm Inspection message 6-54
- Machine Room Heat Detectors Activated message 6-54
- Machine Room Heat Detectors Deactivated message 6-54
- Machine Room Inspection Disabled message 6-54
- Machine Room Inspection Enabled message 6-54
- Machine Room Inspection mode 9-7
- Machine Room Inspection Operation message 6-54
- Machine Room Inspection output 9-119
- Machine Room Inspection switch 7-12
- Machine Room Inspection, running on 2-54-2-60, ??-2-61, 3-26
- Machine Room Preparation
 - Equipment location 2-4
- Machine Room Stop Switch Open message 6-54
- Main Fire Recall floor 9-44
- Main Floor Smoke input 9-109
- MAIN FLOOR SMOKE message 6-55
- Main Floor Smoke Sensor Recall message 6-55
- Main Processor Board Quick Reference 6-98
- Manual configuration serial inputs 10-56
- Master Security Override input 9-112
- MCE 5-18
- MCE job number parameter 10-7
- MCE Load Weigher 5-63-5-69
 - adjusting 5-68
 - installation 5-63
 - maintaining 5-68
 - wiring 5-67
- MCE Load Weigher. See also Load Weigher
- MCE Loadweigher-Isolated Platform 3-19
- MCE System hub 5-10, 5-12
- MD, Motor Drive relay indicator 11-12

- MDRD, Motor Drive Redundancy indicator 11-12
- Mechanical Safe Edge 9-30
- Mechanically In Service output 9-119
- Melina PI display Outputs 9-122
- Menu tree, iBox LCD display 7-6
- MF FORCING TIMED OUT message 6-55
- MF1, MF2, DC power to motor field 11-14
- Minimum Floor to Floor Time specification 11-2
- Mode of Operation 5-26, 9-5, 10-14
- Mode of Operation Config inputs 9-112
- Mode of Operation Config outputs 9-123
- monitoring Diagnostic Outputs 9-13
- Motion
 - Actual direction 9-9
 - Category 9-9
 - Commanded direction 9-9
- Motion Start Fault message 6-55
- Motion stopped due to IO toggle test message 6-55
- MOTION STOPPED-IO TST message 6-55
- Motion, diagnostic flags 9-12
- Motor blower hold delay parameter 9-88
- Motor Blower output 9-122
- MOTOR CNTR PROOF FLT message 6-55
- Motor Contactor Driver Proofing Fault message 6-55
- Motor Contactor Proofing Fault message 6-55
- Motor Contactor Status test point, description 11-5
- Motor Current Limiting 4-14
- Motor Field Forcing Timed Out message 6-55
- Motor insulation 2-21
- Motor Limit Protection Timer Elapsed message 6-55
- MOTOR LIMIT TIMED OUT message 6-55
- Motor Limit Timed Out message 6-55
- MOTOR LMT TIMED OUT 2 message 6-55
- Motor Noise 4-15
- Motor Overload Protection, verifying 2-60
- Motor Triac active indicator 11-12
- MOTR CNTR DRV PRF FLT message 6-55
- Move idle car penalty 10-11
- Move lobby parked car penalty 10-11
- Move non-lobby parked car penalty 10-11
- MR HEAT DETECTORS message 6-54
- MR INSP. DISABLED message 6-54
- MR STOP SWITCH OPEN message 6-54
- MRD, Motor Redundancy indicator 11-12
- Multiple Input AC Board Quick Reference 6-104
- Multiple Output Relay Board Quick Reference 6-107

N

- Network Info 5-26
- Node Control 5-26
- Non-interference timer 9-30
- Non-lobby parking delay 10-21
- Non-lobby shuffle delay 10-21
- Non-peak hall call assignment penalty 10-17
- Normal and Emergency Terminal Switch Position Tests 4-54
- Normal rate limited stop parameter 9-89
- Normal rate limited stop, adjusting for final stop 4-26
- Normal Terminal Slowdown Limit (NTS) 4-9
- Normal Terminal Switch Overspeed Tests 4-53
- Nudging 9-37

- Nudging Front, NUDGING FRONT message 6-56
- Nudging Operation message 6-56
- Nudging Rear, NUDGING REAR message 6-56
- Number of Cars in Group specification 11-2
- Number of Stops specification 11-2

O

- OK Write Privileges 1-13
- Online help, accessing 8-24
- Operational Status tab 9-8
- Orange cables 5-12, 5-35
- Oscilloscope
 - editing displays 8-39, 9-22
 - Enable/Disable Tracking 9-22
 - Scale 9-23
 - Zoom to Fit 9-23
- OTHER CARS ALT FIRE message 6-56
- Other Cars Alternate Fire Sensor Recall message 6-56
- Other Cars Alternate input 9-109
- OTHER CARS MAIN FIRE message 6-56
- Other Cars Main Fire Sensor Recall message 6-56
- Other Cars Main input 9-109
- Outputs, programming 9-115
- Over Current Power Threshold test point, description 11-5
- Over Current test point, description 11-5
- Over Current Threshold test point, description 11-5
- Over Load Input 9-109
- Over Load Threshold 9-127
- Overload output 9-119
- Overload threshold 4-31, 4-32
- Overloaded car detection 4-30
- Overshoot correction, Contract speed runs 4-14
- Overshoot, adjusting for 4-8
- Overspeed 1 9-20
 - description of 4-55
- Overspeed 1 margin, Safety parameter 9-148
- Overspeed 2 9-20
 - description of 4-55

P

- PARAM CHNG-RESET CAR message 6-41
- Parameter adjustment
 - using iView 8-18
 - using the iBox 7-5
- Parameter entry screens 1-13, 8-18
- parameter settings, verifying initial 2-43
- Parameters, Load from Configuration file 8-22
- Parameters, Save to File 8-20
- Parking 10-20
- Parking Config inputs 9-112
- Parking Config outputs 9-123
- Parking Configurations 10-21
- Parking Delay Timers 10-21
- Parking Eligibility 10-27
- Parking Eligibility Config inputs 9-112
- Parking Eligibility Config outputs 9-123
- Partial pick voltage 9-25
- Pass Code Failure output 9-119
- Pass Code Success output 9-119

- Passenger configuration 9-37–9-43
- Passenger mode 9-7
- Passenger Operation, Passenger message 6-56
- Passing Floor Gong Enabled input 9-109
- Passing Floor Gong Enabled output 9-119
- Passing Floor Gong output 9-119
- Pattern - Common parameters 9-129
- Pattern (Command) test point, description 11-5
- Pattern (Directional) test point, description 11-5
- Pattern (Phase) test point, description 11-5
- Pattern (Raw) test point, description 11-5
- Pattern (Region) test point, description 11-5
- Pattern (Slew Limited) test point, description 11-5
- Pattern Filtered test point, description 11-5
- Pattern Interpolated test point, description 11-5
- Pattern phase 9-10
- Pattern profile 9-10
- Pattern profile parameters 4-12, 9-128–9-133
- Pattern scaling parameter 9-129
- Pattern shape preset 9-132
- Pedestal Fabrication 3-4
- Per floor parking 10-21
- Peripheral hub 5-10, 5-11, 5-13, 5-21
- Peripheral TCP/IP 5-11
- Photo Eye 9-31
- Photo Eye Anti-nuisance 9-38
- Photo Eye Antinuisance message 6-56
- Photo Eye Bypass Timer 9-31
- Pick delay 9-26
- Pick voltage 2-51, 2-53, 9-25
- Pinging 5-24
- pinning and unpinning windows in iView 8-33
- PM gearless machines, synchronizing with AC drive 2-25, 2-45
- Position Bit test point, description 11-6
- Position Cartop Offset Fault message 6-56
- Position encoder resolution
 - parameter 9-129
 - verifying 3-27
- Position iBox Connections 6-112, 11-7
- Position indicators Binary Outputs 9-121
- Position indicators Rotodial Outputs 9-121
- Position indicators Single Outputs 9-121
- Position Location Error Fault message 6-56
- Position Margin 4-55
- POSITION QUAD FAULT message 6-57
- Position Quadrature Fault message 6-57
- Position Quadrature Reversed Fault message 6-57
- Position Speed Deviation Fault message 6-57
- Position Speed Threshold Fault message 6-57
- POSITION SYNC-FLOOR message 6-58
- Position Synchronization
 - Floor 9-130
 - Preset parameter 9-130
 - Terminal 9-130
- Position Synchronization Fault message 6-58
- Position Synchronization parameters 9-130
- Position Synchronization Required at Floor message 6-58
- Position Synchronization Required at Terminal message 6-58
- Position Synchronized at Floor message 6-58

- Position Synchronized at Terminal message 6-58
- POSITION SYNC-TERMINAL message 6-58
- POSITN QUAD RVRSD FLT message 6-57
- POSITN SPEED DVTN FLT message 6-57
- POSTN CARTP OFFST FLT message 6-56
- POSTN LCTN ERROR FLT message 6-56
- POSTN SPD THRSHLD FLT message 6-57
- Power bus verification 5-9
- Power line fluctuation 2-4
- Power Transfer input 9-109
- Power Transfer Input Activated message 6-58
- Power Transfer Input Deactivated message 6-58
- Power Transfer, POWER TRANSFER message 6-58
- Power Up Position Synchronization Required at Terminal message 6-58
- PowerBack R6 Regenerative Drive
 - Parameters Quick Reference 11-31
- Preparing for Final Adjustments 3-28
 - counterweight balancing 3-29
 - door operator 3-28
 - empty car tests 3-31
 - run testing 3-28, 3-30
- Pre-Run Status test point, description 11-6
- preset profile parameters 9-132
- Pre-start Door Lock Fault message 6-59
- Pre-Start Sequence 4-35–4-40
 - diagrams 4-36
 - parameters 4-35, 9-88
- Pretorque (Raw) test point, description 11-6
- Pretorque Command test point, description 11-6
- Pretorque Gain, adjusting 4-17
- Pretorque option 4-17
- Pretorque Position Compensation 4-17
- PRI FIRE SWITCH BYP message 6-59
- PRI FIRE SWITCH ON message 6-59
- Primary Fire Switch BYPASS input 9-109
- Primary Fire Switch Bypass message 6-59
- Primary Fire Switch OFF input 9-109
- Primary Fire Switch ON input 9-109
- Primary Fire Switch On message 6-59
- Printing screens in iView 8-38
- Processed pattern frequency parameter 9-91
- programmable inputs 9-106
- programmable outputs 9-115
- Pulses per foot, Safety parameter 9-148

Q

- QPRAM Device Error message 6-59
- Quadrature Pulse Indicators 3-12
- Quadrature Pulse Sequence 3-27
- Quadrature Pulse Voltages 3-27
- Quadrature Sensor Adjustment 3-3

R

- R DPM OPEN-GS CLOSED message 6-61
- R DR CLS FLT REC FAIL message 6-60
- R6 Regenerative AC drive parameters 11-31
- Rated motor RPM parameter 9-89
- Raw pattern frequency parameter 9-91

RB resistor, adjusting 2-22
 Rear Auxiliary Door Close Button input 9-110
 Rear Car Calls COP2 inputs 9-111
 Rear Constant Pressure Close (Rear Door) input 9-110
 Rear Constant Pressure Open (Rear Door) input 9-110
 Rear COP2 Door Close Button input 9-110
 Rear COP2 Door Hold Button input 9-110
 Rear COP2 Door Open Button input 9-110
 Rear COP2 Door Stop Button input 9-110
 REAR DOB BYPASSED message 6-60
 Rear Door Board Quick Reference 6-103
 Rear Door Car Gong output 9-120
 Rear Door Close Button (COP1) input 9-110
 REAR DOOR CLOSE FAULT message 6-59
 Rear Door Close Fault message 6-59
 Rear Door Close Fault Recovery Failure message 6-60
 Rear Door Close Limit input 9-110
 Rear Door Close Limit output 9-120
 Rear Door Close Time-out message 6-60
 Rear Door Closing Warning Buzzer output 9-120
 Rear Door Contact Fault message 6-60
 REAR DOOR CONTACT FLT message 6-60
 Rear Door Disable Automatic Close output 9-120
 Rear Door Disable Hall Door Buttons output 9-120
 Rear Door Enable output 9-120
 Rear Door Hold Button (COP1) input 9-110
 Rear Door Hold Function output 9-120
 Rear Door Left Open output 9-120
 Rear Door Lock Power output 9-120
 Rear Door Open Button (COP1) input 9-110
 Rear Door Open Button Bypassed message 6-60
 Rear Door Open Fault message 6-61
 Rear Door Open Limit input 9-110
 Rear Door Open Time-out message 6-61
 Rear Door Photo Eye input 9-111
 Rear Door Stop Button (COP1) input 9-111
 REAR DOORS STOPPED message 6-60, 6-61
 Rear Doors Stopped message 6-60, 6-61
 Rear Down Car Lantern output 9-120
 Rear DPM Open - GS Closed message 6-61
 REAR HALL DOB BYP message 6-61
 Rear Hall Door Close Button input 9-111
 Rear Hall Door Hold Button input 9-111
 Rear Hall Door Open Button input 9-111
 Rear Hall Door Open Button Bypassed message 6-61
 Rear Hall Door Stop Button input 9-111
 Rear Momentary Pressure Close (Rear Door) input 9-111
 Rear Momentary Pressure Open (Rear Door) input 9-111
 Rear Nudging Audible output 9-121
 REAR PHOTO EYE BYP message 6-62
 Rear Photo Eye Bypassed message 6-62
 Rear Photo Eye Cut Out input 9-111
 REAR PHOTO EYE FAIL message 6-62
 Rear Photo Eye Failure message 6-62
 REAR SAFE EDGE BYP message 6-62
 Rear Safe Edge Bypassed message 6-62
 REAR SAFE EDGE FAIL message 6-62
 Rear Safe Edge Failure message 6-62
 Rear This Car Up output 9-121
 Rear Up Car Lantern output 9-121

Recall Switch 1 - 6 output 9-119
 Recall Switch input 9-109
 Receive Sys Params message 6-62
 Reduced Inspection Speed option parameter 9-132
 Register a car call 4-4
 Relay Board Quick Reference 6-100
 Relay output selection 5-47, 6-107, 6-120
 Relevel dead zone distance parameter 9-130
 Relevel distance parameter 9-130
 Relevel voltage 9-25
 Relevel, iBox status LED 7-11
 Relevel, verifying 4-6
 Releveling 4-29
 Releveling speed parameter 9-130
 Remote Monitoring Authorization 10-31
 Remote Outputs tab 10-66
 Remote User Outputs 10-59
 Repick time 9-26
 Reset EQ board 3-21
 Reset Rope Gripper 2-29
 resizing windows in iView 8-34
 RESTRICTED message 6-62
 Restricted message 6-62
 RET CAM PROTECTIN FLT message 6-63
 Retask penalty 10-11
 RETIRING CAM DLK FLT message 6-63
 Retiring Cam Door Lock Fault Activated message 6-63
 Retiring Cam Door Lock Fault Deactivated message 6-63
 Retiring Cam Door Lock Fault message 6-63
 Retiring Cam output 9-119
 Retiring Cam Protection Fault Activated message 6-63
 Retiring Cam Protection Fault Deactivated message 6-63
 Retiring Cam Protection Fault message 6-63
 RFI noise, proper grounding 2-14
 RFI, Radio Frequency Radiation 2-4
 RFI/EMI noise, reducing 2-21
 Ride quality, adjusting 4-30
 Ring and String circuit 3-21
 Rollback adjustment, Speed pick delay 4-7
 Rollback, controlling 4-16
 Rope Gripper 2-29
 Rope Gripper Board Quick Reference 6-109
 Rope Gripper Bypass 2-29
 Rope Gripper Reset 2-29
 Rope Gripper Wiring 2-29
 Rope Stretch Releveling 4-29
 Rope Tension Load Weigher 4-30
 Rotational coupling ratio parameter 9-89
 Rough Acceleration or Deceleration 4-15
 Run Sequence 10-35
 Run testing, preparing for final adjustments 3-30
 Run, iBox status LED 7-11
 RX-, Cartop Link input 6-113, 11-8
 RX+, Cartop Link input 6-113, 11-8

S

Sabbath Operation Activated message 6-63
 Sabbath Operation Deactivated message 6-63
 Sabbath Operation Indicator output 9-119
 Sabbath Operation mode 9-7

Sabbath Operation parameters 9-81
 Sabbath Operation Switch input 9-109
 Sabbath Operation, SABBATH OPERATION message 6-63
 Sabbath Override Input 9-109
 SAFC, Safety Cartop input 11-12
 Safe Edge Bypass Timer 9-30
 Safety 3-25
 Safety A Contract Overspeed Fault message 6-63
 Safety A IMP Configuration Mismatch message 6-64
 Safety A Inspection Leveling Overspeed Fault message 6-64
 Safety A Inspection Overspeed Fault message 6-64
 Safety A SIB Device Fault message 6-64
 Safety A SIB Device Fault Off message 6-64
 Safety A UETS Level 2 Speed Fault message 6-64
 Safety A Unintended Motion Fault message 6-64, 6-66
 Safety A, iBox status LED 7-11
 Safety B Contract Overspeed Fault message 6-65
 Safety B DETS Level 2 Speed Fault message 6-65
 Safety B Fault Bypass Switch Timed Out message 6-65
 Safety B Inspection Leveling Overspeed Fault message 6-65
 Safety B Inspection Overspeed Fault 6-65
 Safety B Safety Bypass Jumper Timed Out message 6-65
 Safety B SIB Device Fault message 6-65
 Safety B SIB Device Fault Off message 6-65
 Safety B UETS Level 2 Speed Fault message 6-66
 Safety B, iBox status LED 7-11
 Safety Board Quick Reference 6-111
 Safety Bypass Jumper 1-7, 6-3
 Safety Bypass Jumper On message 6-66
 Safety Bypass Jumper on the iBox 7-13
 Safety Bypass Jumper Time Out message 6-66
 Safety C String Open message 6-66
 Safety C String Open Off message 6-66
 Safety Clamp 3-17
 Safety Configuration 9-147
 Contract overspeed 9-148
 Contract speed 9-148
 Inspection overspeed 9-148
 Learning 9-149
 Leveling overspeed 9-148
 Overspeed 1 margin 9-148
 Pulses per foot 9-148
 Safety Configuration Checksum Fault message 6-66
 Safety Configuration Learn Fault message 6-66
 Safety Configuration Mismatch message 6-67
 Safety Configuration Vector Cross Check Fault message 6-67
 Safety Configuration, learning the 2-46
 Safety Connections, iBox 11-12
 Safety H String Open message 6-67
 Safety H String Open Off message 6-67
 Safety Inventory Checksum Fault message 6-67
 Safety Inventory Comparison Fault message 6-67
 Safety Inventory Creation Fault message 6-67
 Safety Inventory Learn Fault message 6-68
 Safety OK, iBox status LED 7-11
 Safety parameters 9-90
 Safety String 2-27
 Safety String Bypass Jumper 1-7
 Safety String Bypass Jumper, troubleshooting 6-3
 Safety String Closed message 6-68
 Safety String Open message 6-68
 Safety system, description 1-3
 Safety Tests 4-43–4-56, 9-152
 Car/Counterweight Buffer 4-46
 Car/Counterweight Safety 4-45
 Contract Overspeed 4-47
 Electrical Governor 4-46
 Emergency Brake - Unintended Motion for Machine Brake 4-49
 Emergency Brake - Unintended Motion for Rope Gripper 4-48
 Emergency Terminal Switch Overspeed 4-54
 Inspection Overspeed 4-47
 Leveling Overspeed Test 4-48
 Normal and Emergency Terminal Switch Position 4-54
 Normal Terminal Switch Overspeed 4-53
 Safety, diagnostic flags 9-12
 SAFH, Safety Hoistway input 11-12
 Saving parameters to a configuration file 8-20
 SC/ION board addresses 5-47, 6-120
 SC/ION output selection 5-47, 6-107, 6-120
 SC-HCDA-ISO Serial Hall Call Driver Isolation Board Quick Reference 6-117
 SC-HCE-EM 5-36
 SC-HCE-ME 5-36
 SC-HCE-ME Serial Hall Call Ethernet - Digi ME Board Quick Reference 6-118
 SC-HCN Serial Hall Call Node Board Quick Reference 6-119
 SC-ION boards 5-11, 5-45, 6-120
 SC-ION Serial Control I/O Board Quick Reference 6-120
 SCOP BUSS 'n' COMM FAULT message 6-72
 SCOP BUSS 'n' INVENTORY FLT message 6-72
 SCR Current Sensor Offset Status test point, description 11-6
 SCR Intg Offset Status test point, description 11-6
 SEC FIRE SWITCH ON message 6-72
 Second Level 5-4, 5-45
 Secondary Fire Switch ON input 9-109
 Secondary Fire Switch On message 6-72
 Sector dispatching 10-25
 Sector parking 10-21
 Sector parking conditions 10-25
 Secured, Security status 10-42, 10-45
 Security
 Car call - Mode overrides 10-47
 Car Call restrictions 10-45
 Car Calls - Passcodes 10-48
 Car Calls - Per-passenger passcodes 10-49
 description 10-38
 General - Configuration 10-39
 Hall Call restrictions 10-42
 Hall calls - Per-car lock out 10-44
 Hall calls, Per-floor security 10-42
 manage passwords 10-40
 Security Config inputs 9-112
 Security Config outputs 9-123
 Security configuration 10-38–10-50
 Security Override inputs 10-58
 Security Override serial inputs 10-58
 Security settings 10-38
 Seismic Switch output 9-119

- Sending parameter settings to the controller 8-19
- Sequential Step Scan Car Call inputs 9-111
- Sequential step scan car calls option 9-99
- Serial bus, wiring 5-32
- Serial Car Operating Panel Board Quick Reference 6-83
- Serial Control I/O Board Quick Reference 6-120
- Serial COP 3-22, 5-48–5-52
 - connections to ilink 3-15
 - description of 5-48
 - diagnostics 6-84
 - installing 5-51
 - specifications 5-50
- Serial COP Bus 'n' Comm Fault message 6-72
- Serial COP Bus 'n' Inventory Fault message 6-72
- Serial Driver 5-11, 5-35
- Serial Fixture Addresses 5-33
- Serial fixtures 9-35
 - Flash direction arrow while running 9-35
 - programming 9-36
 - Serial Messages 9-35
 - Start Floor Arrival Announcement 9-35
- Serial Fixtures Board Quick Reference 6-116
- Serial hall call 5-11
- Serial Hall Call Driver 5-30
- Serial Hall Call Driver Isolation Board Quick Reference 6-117
- Serial Hall Call Driver Testing 5-43
- Serial Hall Call Ethernet - Digi ME Board Quick Reference 6-118
- Serial Hall Call Node Board Quick Reference 6-119
- Serial Hall Call option 5-30–??
- Serial Hall Call System 3-22
 - Bus Voltages 5-30
- Serial I/O 10-51–10-61
 - configuring I/O 10-53
 - Input test 10-61
 - Output test 10-61
 - System tab 10-51
 - Wrapback option 10-60
- Serial number, viewing on iBox 7-8
- Serial to TCP/IP 5-11, 5-35
- Serial-to-Ethernet converters 5-35
- Serviceability, description 1-3
- Set Time/Date 7-8
- Setting PC IP Addresses 5-18
- setting the active configuration 9-99
- Setting the date and time in iView 8-38
- Setup 9-140–9-151
 - Brake 9-140
 - Counterweight 9-141
 - Drive 9-142
 - Floor Heights 9-143
 - Floor Heights - Floor Offsets tab 9-145
 - Load Weigher 9-146
 - Safety 9-147, 9-149
 - Safety - Inventory 9-150
 - Terminal Switches 9-151
- SFTY CONFIG CHKSM FLT message 6-66
- SFTY CONFIG LEARN FLT message 6-66
- SFTY CONFIG MISMATCH message 6-67
- SFTY INVTRY CHKSUM FLT message 6-67
- SFTY INVTRY COMPARE FLT message 6-67
- SFTY VCTR XCHK FLT message 6-67
- Sheave Brake Drop Fault message 6-73
- SHEAVE BRAKE DROP FLT message 6-73
- Sheave Brake Enable output 9-122
- Sheave Brake Monitor input 9-112
- Sheave Brake Pick Fault message 6-73
- SHEAVE BRAKE PICK FLT message 6-73
- SHLD, Tach Signal input 6-112, 11-7
- Shorts to ground 2-16, 5-7
- Shuttle service 9-7
- Shuttle Service Activated message 6-73
- Shuttle Service Deactivated message 6-73
- Shuttle service input 9-109
- SHUTTLE SERVICE OFF message 6-73
- SHUTTLE SERVICE ON message message 6-73
- Shuttle service output 9-119
- Shuttle service override input 9-109
- Shuttle service parameters 9-84
- Simplex car parameter 9-95
- Simplex car, description of 10-4
- Simplex Dispatching 10-6–??
- Single Channel QUAD Fault message 6-73
- SNG CHANNEL QUAD FLT message 6-73
- Softkeys, iBox controls 7-4
- SOFTWARE RECALL ON message 6-73
- Software Recall Switch Activated message 6-73
- Software Test Points 11-3
- SP 1, Spare input 1 6-115, 11-11
- SP1 D, Optional input 11-12
- SP2 D, Optional Brake Pick switch input 11-12
- SP2, Optional input 11-12
- SP3, Optional input 11-12
- SP4, Optional input 11-12
- SPA COS FAULT message 6-63
- SPA DETS L2 SPEED FLT message 6-63
- SPA DETS Level 2 Speed Fault message 6-63
- SPA IOS FAULT message 6-64
- SPA LOS FAULT message 6-64
- SPA SIB DEVICE FAULT message 6-65
- SPA Spare Event 'n' (n = 1 to 8) message 6-73
- SPA UETS L2 SPD FLT message 6-64
- SPA UNTD MOTION FLT 6-64
- Spares Connections, iBox 11-12
- SPB COS FLT message 6-65
- SPB DETS L2 SPEED FLT message 6-65
- SPB IOS FAULT message 6-65
- SPB LOS FAULT message 6-65
- SPB SIB DEVICE FAULT message 6-64
- SPB UETS L2 SPD FLT message 6-66
- SPB UNTD MOTION FLT 6-66
- Specifications 11-2
- Specifications, iControl AC specifications 11-2
- Speed Bit test point, description 11-6
- Speed Feedback test point, description 11-6
- Speed Feedback, verifying 2-56
- Speed partial pick delay 9-26
- Speed pick delay 4-7, 4-19, 9-26
 - adjusting 3-31
- speed profiles, adjusting 4-12

- Speed Reference
 - Following error 9-90
- Speed reference frequency parameter 9-91
- Speed Reference parameters 9-89, 9-90
- Speed reference resolution parameter 9-89
- Speed reference rotational direction parameter 9-89
- Speed reference scaling parameter 9-89
- Speed reference type parameter 9-89
- Speed Reference, setting 2-56
- speed variance, up vs. down 2-57
- Split Bank 10-29
 - Activation 10-29
 - Deactivation 10-29
 - Hall call eligibility 10-30
 - Hall Risers 10-30
 - Riser connections 10-58
- Standard profile 4-13, 9-128
- Status display, iBox LEDs 7-11
- Status messages on the iBox LCD display 7-12
- Stuck Car Panel Inspection Input message 6-74
- Stuck Cartop Inspection Input message 6-74
- STUCK CP INSP. INPUT message 6-74
- STUCK CT INSP. INPUT message 6-74
- STUCK IN. INPUT FLT message 6-74
- Stuck Inspection Input Fault message 6-74
- Sub-address jumper 5-34
- Subnet Mask 2-34, 7-9, 8-4
- Sufficient Field Status test point, description 11-6
- Support availability 1-3
- Swing Automatic Operation input 9-109
- Swing car, description of 10-4
- Swing Dispatching 10-6-??
- Swing operation
 - Enable 9-39
 - parameters 9-39
- Swing Operation Activated message 6-74
- Swing Operation Deactivated message 6-74
- Swing Operation Indicator output 9-119
- Swing Operation message 6-74
- Swing Operation Switch input 9-109
- Switching between PCs 5-2
- Switching the monitor 5-2
- Symbols 2-8
- Synthetic Signal test point, description 11-6
- Sys Comm, iBox status LED 7-11
- System 12 SCR Drive
 - auto offset calibration 2-48
 - initial settings 2-48
- System Configurations (Simplex) inputs 9-112
- System Configurations (Simplex) outputs 9-123
- System Control Switches 1-7
- System control switches on the iBox 7-12
- System Event Log 10-68
 - open saved file 10-68
 - save to file 10-68
- System Event log, view details 10-68
- System I/O
 - Input inventory 10-61
 - Output inventory 10-61
- System I/O configuration 10-51

- System I/O Troubleshooting 5-36
- System monitoring 1-1
- System Options 5-1-5-52
 - MCE Load Weigher 5-63-5-69
 - Serial COP 5-48-5-52
 - Serial Hall Calls 5-30-??
- System Performance 10-74
- System Status Display 1-7
- System status, Fault bypass 9-18
- SYSTEM SYNC message 6-73, 6-74
- System TCP/IP 5-11
- System User Outputs 9-124
- System View 9-1
- System view 10-2

T

- Tach Error Fault message 6-74
- Tach Error Lower Limit test point, description 11-6
- Tach Error tripping threshold adjustment 4-41
- Tach Error Upper Limit test point, description 11-6
- Tach Failure, TACH FAILURE message 6-74
- Tachometer iBox Connections 6-112, 11-7
- Tachometer Signal test point, description 11-6
- TB, Brake Triac active indicator 11-12
- TC, Tach Signal input 6-112, 11-7
- TCP/IP 5-11, 5-14, 5-35
- TCP/IP Addresses 2-5, 2-30, 2-34, 5-15, 5-18, 8-4
 - setting in iView 9-125
 - setting on the iBox 7-9
- TCP/IP cables 5-12
- Temporary Cartop Wiring 2-29
- Temporary CTS Relay Bypass 2-28
- TERMINAL LEARN ON message 6-75
- Terminal Learn procedure 9-151
- Terminal switches configuration 9-134
- Terminal switches status 9-19
- TERMINAL SYNC FAULT message 6-75
- Terminal synchronization 4-3, 9-130
- Terminal Synchronization Fault message 6-75
- Terminals, input and output wiring 2-13
- Test mode 9-7
- Test Mode message or Test message 6-75
- Test Mode output 9-120
- Test point signal descriptions 11-3-11-6
- Test switch, iBox control 7-12
- THIS CAR ALT FIRE message 6-75
- This Car Alternate Fire Sensor Recall message 6-75
- This Car Alternate input 9-109
- THIS CAR MAIN FIRE message 6-75
- This Car Main Fire Sensor Recall message 6-75
- This Car Main input 9-110
- Time, setting 8-38
- Timer tables
 - configuration 10-62
 - configuring 9-135
 - examples 9-137, 10-64
 - programming 9-135, 10-62
- TM, Motor Triac active indicator 11-12
- Toggle Output 9-124

- TORQMAX Drive 1-10, 3-31
 - adjusting for motor current limiting 4-14
 - Auto-tuning for induction motors 2-54
 - fine tuning 4-11
 - Synchronizing PM gearless machines 2-25, 2-45
 - verifying car direction 2-55
- TORQMAX Drive Parameters Quick Reference 11-27
- TORQMAX Drive, verifying parameters 2-47
- Traveling cable 2-9
- Troubleshooting 6-1–??
 - Circuit boards 6-82–6-122
 - ICE-COP board diagnostics 6-84
 - ICE-COP, Serial Car Operating Panel Board Quick Reference 6-83
 - ICE-CTP Cartop Processor Board diagnostics 6-89
 - ICE-CTP Cartop Processor Board Quick Reference 6-86
 - ICE-EB Emergency Brake Board Quick Reference 6-92
 - ICE-FML Field Module Logic Board Quick Reference 6-93
 - ICE-IEQ Earthquake Board Quick Reference 6-96
 - ICE-IMP Main Processor Board Quick Reference 6-98
 - ICE-IRB Relay Board Quick Reference 6-100
 - ICE-IRD Rear Door Board Quick Reference 6-103
 - ICE-MIAC Multiple Input AC Board Quick Reference 6-104
 - ICE-MOR Multiple Output Relay Board Quick Reference 6-107
 - ICE-RG Rope Gripper Board Quick Reference 6-109
 - ICE-SAF Safety Board Quick Reference 6-111
 - ICE-SF Serial Fixtures Board Quick Reference 6-116
 - iControl messages 6-13–6-78
 - iLink 6-89
 - removing & replacing circuit boards 6-79
 - replacing the iBox 6-80
 - SC-HCDA-ISO Serial Hall Call Driver Isolation Board Quick Reference 6-117
 - SC-HCE-ME Serial Hall Call Ethernet - Digi ME Board Quick Reference 6-118
 - SC-HCN Serial Hall Call Node Board Quick Reference 6-119
 - SC-ION Serial Control I/O Board Quick Reference 6-120
 - Serial Hall Call (and I/O) 5-36
 - Tools 6-2
 - Using the Data trap 9-11
 - using the Safety String Bypass Jumper 6-3
- TS, Tach Signal input 6-112, 11-7
- TX-, Cartop Link input 6-113, 11-8
- TX+, Cartop Link input 6-113, 11-8

U

- UETS, Up Emergency Terminal Limit switch input 6-114, 11-9
- ULM, Up Leveling Marker Sensor input 6-113, 11-8
- Unintended Motion Fault message 6-75
- UNINTENDED MOTION FLT message 6-64
- Unsecured, Security status 10-42, 10-45
- UNT1, Up Slowdown Limit switch #1 input 6-114, 11-9
- UNT2, Up Slowdown Limit switch #2 input 6-114, 11-9
- UNT3, Up Slowdown Limit switch #3 input 6-114, 11-9
- UNT4, Up Slowdown Limit switch #4 input 6-114, 11-9
- UNT5, Up Slowdown Limit switch #5 input 6-114, 11-9

- UNTD, Up Normal Limit Direction switch input 6-114, 11-9
- UP DIR LIMIT OPEN message 6-76
- Up Direction Limit Open message 6-76
- Up Emergency Terminal Switch Position Fault message 6-76
- Up Emergency Terminal Switch Shutdown message 6-76
- UP ETS POSITION FAULT message 6-76
- UP ETS SHUTDOWN message 6-76
- Up Level 3-2
- Up Levelling Marker (ULM) 3-12
- Up Normal Terminal Switch 'n' Level 1 Speed Fault message 6-77
- Up Normal Terminal Switch 'n' Level 2 Speed Fault message 6-77
- Up Normal Terminal Switch 'n' Position Fault message 6-78
- UP NTSn L1 SPEED FLT message 6-77
- UP NTSn L2 SPEED FLT message 6-77
- UP NTSn POSITION FLT message 6-78
- Up switch, iBox control 7-12
- Up, iBox status LED 7-11
- up/down speed difference, adjusting for 4-11
- Upgrade Options 9-157
- User code accessing an invalid logical indicator (internal event) message 6-78
- USER DEF EVENT FAULT message 6-78
- User Defined Event 'n' Off message 6-78
- User Defined Event 'n' On message 6-78
- User Defined Event Fault message 6-78
- User Defined Events 10-59
- User defined parking 10-21, 10-23, 10-26
- User Events 10-65
- User-Defined Events inputs 9-114

V

- VE-, Velocity Encoder input 6-112, 11-7
- VE+, Velocity Encoder input 6-112, 11-7
- Vector Checksum Fault 6-78
- Vector Comparison Fault 6-78
- Vector Creation Fault 6-78
- Vector Learn Fault 6-78
- Velocity Encoder
 - Connections 2-25, 6-112, 11-7
 - connections 2-25
 - encoder cables 2-26
 - installation 2-24
 - isolation 2-25
 - mounting 2-24
 - wiring 2-25
- verify releveling 4-6
- verifying brake current resistance 2-22
- Verifying Correction and Stop 4-3
- verifying initial parameter settings 2-43
- Verifying Main Line Power 2-18
- verifying Motor Overload Protection 2-60
- verifying Speed feedback 2-56
- Version Info, viewing on iBox 7-8
- View and set parameters on the iBox 7-5
- View Event Log Details 9-15
- View factory data on iBox 7-8
- View menu
 - contents 8-26

View/register calls using iBox 7-8
Virtual Oscilloscope 1-14
 See also Oscilloscope
Voltage decay time 9-26
Voltage decay time, adjusting for final stop 4-26, 4-28

W

Watchdog 5-27
Watchdog Ordered Control Stop Before Reset message 6-78
Watchdog Ordered Emergency Stop Before Reset message 6-78
Weakening delay parameter 4-20, 9-26
Weakening voltage 2-51, 9-25
Windows XP 5-21
wiring
 AC power 2-17
 inputs and outputs 2-12
 the serial hall call fixtures 5-32
 typical connection locations 2-11
 Velocity Encoder 2-25
Wiring the Brake 2-23
Wiring the Hoist Motor 2-21
Working offline, editing a configuration file 8-23
Wrapback, Serial I/O option 10-60
Write Enable switch, iBox control 7-12
Write permission 5-26
Write permission approval 5-26
Write privilege
 Acquire 1-13
 acquiring 2-30, 2-43
 OK 1-13, 2-30, 2-43
Write privilege timeout 5-26

Z

Z-, Velocity Encoder input 6-112, 11-7
Z+, Velocity Encoder input 6-112, 11-7