



**Motion Control Engineering, Inc.  
11380 White Rock Road  
Rancho Cordova, CA 95742**

voice 916 463 9200  
fax 916 463 9201  
[www.mceinc.com](http://www.mceinc.com)

**Motion 4000 Traction Elevator Controller  
V8.x Software**

---

## **Copyright**

© 2012, Motion Control Engineering. All Rights Reserved.

This document may not be reproduced, electronically or mechanically, in whole or in part, without written permission from Motion Control Engineering.

## **Trademarks**

All trademarks or registered product names appearing in this document are the exclusive property of the respective owners.

## **Warning and Disclaimer**

Although every effort has been made to make this document as complete and accurate as possible, Motion Control Engineering and the document authors, publishers, distributors, and representatives have neither liability nor responsibility for any loss or damage arising from information contained in this document or from informational errors or omissions. Information contained in this document shall not be deemed to constitute a commitment to provide service, equipment, or software by Motion Control Engineering or the document authors, publishers, distributors, or representatives.

## **Limited Warranty**

Motion Control Engineering (manufacturer) warrants its products for a period of 15 months from the date of shipment from its factory to be free from defects in workmanship and materials. Any defect appearing more than 15 months from the date of shipment from the factory shall be deemed to be due to ordinary wear and tear. Manufacturer, however, assumes no risk or liability for results of the use of the products purchased from it, including, but without limiting the generality of the forgoing: (1) The use in combination with any electrical or electronic components, circuits, systems, assemblies or any other material or equipment (2) Unsuitability of this product for use in any circuit, assembly or environment. Purchasers' rights under this warranty shall consist solely of requiring the manufacturer to repair, or in manufacturer's sole discretion, replace free of charge, F.O.B. factory, any defective items received at said factory within the said 15 months and determined by manufacturer to be defective. The giving of or failure to give any advice or recommendation by manufacturer shall not constitute any warranty by or impose any liability upon the manufacturer. This warranty constitutes the sole and exclusive remedy of the purchaser and the exclusive liability of the manufacturer, AND IN LIEU OF ANY AND ALL OTHER WARRANTIES, EXPRESSED, IMPLIED, OR STATUTORY AS TO MERCHANTABILITY, FITNESS, FOR PURPOSE SOLD, DESCRIPTION, QUALITY PRODUCTIVENESS OR ANY OTHER MATTER. In no event will the manufacturer be liable for special or consequential damages or for delay in performance of this warranty.

Products that are not manufactured by MCE (such as drives, CRTs, modems, printers, etc.) are not covered under the above warranty terms. MCE, however, extends the same warranty terms that the original manufacturer of such equipment provide with their product (refer to the warranty terms for such products in their respective manual).

---

## **End User License Agreement**

This End User License Agreement ("Agreement") grants you the right to use the software contained in this product (the "Software") subject to the following restrictions: You may not: (i) copy the Software, except for archive purposes consistent with your standard archive procedures; (ii) transfer the Software to a third party apart from the entire product; (iii) modify, decompile, disassemble, reverse engineer or otherwise attempt to derive the source code of the Software; (iv) export the Software or underlying technology in contravention of applicable U.S. and foreign export laws and regulations; and (v) use the Software other than in connection with operation of the product.

"LICENSOR'S SUPPLIERS DO NOT MAKE OR PASS ON TO END USER OR ANY OTHER THIRD PARTY, ANY EXPRESS, IMPLIED OR STATUTORY WARRANTY OR REPRESENTATION ON BEHALF OF SUCH SUPPLIERS, INCLUDING BUT NOT LIMITED TO THE IMPLIED WARRANTIES OF NON-INFRINGEMENT, TITLE, MERCHANTABILITY OR FITNESS FOR A PARTICULAR PURPOSE."

---

## Important Precautions and Useful Information

This preface contains information that will help you understand and safely maintain MCE equipment. We strongly recommend you review this preface and read this manual before installing, adjusting, or maintaining Motion Control Engineering equipment. This preface discusses:

- Safety and Other Symbol Meanings
- Safety Precautions
- [Environmental Considerations](#)
- [In This Guide](#)

## Safety and Other Symbol Meanings



### Danger

This manual symbol is used to alert you to procedures, instructions, or situations which, if not done properly, might result in personal injury or substantial equipment damage.



### Caution

This manual symbol is used to alert you to procedures, instructions, or situations which, if not done properly, might result in equipment damage.



### Note

This manual symbol is used to alert you to instructions or other immediately helpful information.

## Safety Precautions



### Danger

This equipment is designed to comply with ASME A17.1, National Electrical Code, CE, and CAN/CSA-B44.1/ASME-A17.5 and must be installed by a qualified contractor. It is the responsibility of the contractor to make sure that the final installation complies with all local codes and is installed in a safe manner.

This equipment is suitable for use on a circuit capable of delivering not more than 10,000 rms symmetrical amperes, 600 volts maximum. The three-phase AC power supply to the Drive Isolation Transformer used with this equipment must originate from a fused disconnect switch or circuit breaker sized in conformance to all applicable national, state, and local electrical codes in order to provide the necessary motor branch circuit protection for the Drive Unit and motor. Incorrect motor branch circuit protection will void the warranty and may create a hazardous condition.

Proper grounding is vitally important to safe and successful operation. Bring your ground wire to the system subplate. You must choose the proper conductor size and minimize the resistance to ground by using the shortest possible routing. See National Electrical Code Article 250 or the applicable local electrical code.

---

Before applying power to the controller, physically check all the power resistors and other components located in the resistor cabinet and inside the controller. Components loosened during shipment may cause damage.

For proper operation of the AC Drive Unit in your controller, you must make sure that: 1) A direct solid ground is provided in the machine room to properly ground the controller and motor. Indirect grounds such as the building structure or a water pipe may not provide proper grounding and could act as an antenna to radiate RFI noise, thus disturbing sensitive equipment in the building. Improper grounding may also render any RFI filter ineffective. 2) The incoming power to the controller and the outgoing power wires to the motor are in their respective, separate, grounded conduits.

This equipment may contain voltages as high as 1000 volts. Use extreme caution. Do not touch any components, resistors, circuit boards, power devices, or electrical connections without ensuring that high voltage is not present.

## Environmental Considerations

- Keep the machine room clean.
- Controllers are generally in NEMA 1 enclosures.
- Do not install the controller in a dusty area.
- Do not install the controller in a carpeted area.
- Keep room temperature between 32 and 104 degrees F (0 to 40 degrees C).
- Prevent condensation on the equipment.
- Do not install the controller in a hazardous location or where excessive amounts of vapors or chemical fumes may be present.
- Make certain that power line fluctuations are within plus or minus 10% of proper value.

## Air Conditioned Equipment Cabinets

If your control or group enclosure is equipped with an air conditioning unit, it is very important to observe the following precautions. (Failure to do so can result in moisture damage to electrical components.)

- Maintain the integrity of the cabinet by using sealed knockouts and sealing any holes made during installation.
- Do not run the air conditioning while the cabinet doors are open.
- If you turn the air conditioner off while it is running, wait at least five minutes before restarting it. Otherwise, the compressor may be damaged.
- Observe the recommended thermostat setting (75 degrees) and follow recommended maintenance schedules.
- Make certain that the air conditioning drain tube remains clear to avoid water accumulation in the unit.

---

## In This Manual:

This manual is the installation, adjustment, and troubleshooting guide for the Motion 4000 traction controller. When viewed online as a pdf file, hyperlinks (buttons or blue text) link to related topics and informational websites. The manual includes:

- [Contents](#): Table of Contents. When viewed online as a pdf file, hyperlinks in the Contents link to the associated topic in the body of the manual.
- [Section 1](#). General Information: System description; operating modes
- [Section 2](#). Installation
- [Section 3](#). Final Adjustments
- [Section 4](#). User Interface
- [Section 5](#). Troubleshooting
- [Appendix](#)
- [Index](#): Alphabetical index to help you find information in the manual. When viewed online as a pdf file, index entry page references are hyperlinks to the associated information in the body of the manual.

# Contents

---

## Section 1. Motion 4000 Traction Elevator Control

- In this section** ..... **1-1**
- Motion 4000 Traction Elevator Control Overview** ..... **1-2**
- System Features** ..... **1-3**
- System Component Descriptions** ..... **1-5**
  - Controller Circuit Boards ..... 1-5
  - Hand-Held User Interface ..... 1-6
  - Car ..... 1-6
    - Landing and Positioning ..... 1-6
    - Load Weigher ..... 1-7
    - Cartop Box ..... 1-7
  - Hoistway ..... 1-8
    - Motion 4000 Specific Traveler Cable ..... 1-8
- Operating Mode Descriptions** ..... **1-9**
  - Normal Operation ..... 1-9
  - Inspection Operation ..... 1-9
    - Cartop Inspection ..... 1-9
    - In Car Inspection ..... 1-10
    - Hoistway Access Inspection ..... 1-10
    - Machine Room Inspection ..... 1-10
  - Attendant Operation ..... 1-11
  - Independent Service ..... 1-11
  - Sabbath Operation ..... 1-12
  - Emergency Medical Operation ..... 1-12
  - Hospital Service ..... 1-13
  - Seismic Operation ..... 1-13
    - Mode Exit ..... 1-13
    - Modifiers ..... 1-13
  - Fire Service Operation ..... 1-14
  - Emergency Power Operation ..... 1-14
    - Generator Backup ..... 1-14
    - TAPS Backup ..... 1-14
  - Car Recall ..... 1-15
  - Capture for Test ..... 1-15
  - Test Mode ..... 1-15
- Monitoring and Control Options** ..... **1-16**
  - iMonitor ..... 1-16
  - iReport ..... 1-16
  - BMS-Link ..... 1-17
  - mView ..... 1-17

---

## Section 2. Installation

<b>In this Section</b> .....	<b>2-1</b>
<b>Safety</b> .....	<b>2-2</b>
Personal Safety .....	2-2
Equipment Safety .....	2-3
<b>Preparation</b> .....	<b>2-3</b>
Electrical Noise .....	2-4
EMI/RFI .....	2-4
Recommended Tools and Test Equipment .....	2-4
<b>MCE Wiring Prints</b> .....	<b>2-5</b>
Drawing Number Format .....	2-5
Nomenclature .....	2-5
Power Nomenclature .....	2-5
<b>Controller Installation</b> .....	<b>2-6</b>
Controller Wiring Guidelines .....	2-7
Proper Ground .....	2-7
Check for Shorts to Ground .....	2-9
<b>AC Power Connections</b> .....	<b>2-10</b>
Brake Module .....	2-10
Power Check .....	2-10
<b>Motor, Brake, and Encoder Connection</b> .....	<b>2-11</b>
Motor Connection .....	2-11
Insulation Breakdown Test .....	2-11
Motor Wiring .....	2-11
MRL or Extended Motor Cables .....	2-11
Brake Connection .....	2-12
Standard Brake .....	2-12
Brake Module .....	2-12
Brake Mechanics .....	2-12
Velocity Encoder Installation and Wiring .....	2-13
Encoder Wiring .....	2-13
<b>Emergency Brake Installation</b> .....	<b>2-14</b>
Resetting the Rope Gripper .....	2-14
<b>Initial Power Up</b> .....	<b>2-14</b>
Often Used Procedures .....	2-15
How to check Car Speed: .....	2-15
How to place the car on Inspection Mode Fault Bypass: .....	2-15
How to place the car on Automatic Mode Fault Bypass: .....	2-15
How to change TORQMAX F5 Drive parameter settings: .....	2-16
How to change Magnetek Drive parameter settings: .....	2-16
How to access/set the F7 parameters: .....	2-16
Important .....	2-16
How to Reset Excessive Faults .....	2-16



<b>Auto Tuning and Encoder Data Loading</b> .....	<b>2-17</b>
Torqmax/KeB F5 Drive Introduction .....	2-17
Digital Operator .....	2-17
Keypad Operation .....	2-18
Clear Error .....	2-18
TorqMax/KEB Drive Operation Overview .....	2-20
Drive Motor/Encoder Setup Overview .....	2-20
Check Correct Motor/Control .....	2-20
Check Control Mode .....	2-20
Learn or Enter Motor or Encoder Data .....	2-21
Auto-tuning AC Induction Motors to the F5 Drive .....	2-21
Manual Induction Motor Parameter Entry .....	2-22
The Drive Manual .....	2-22
Loading Data from PM AC Encoder to the F5 Drive .....	2-23
Learning Encoder Data From PM Machines .....	2-23
Setting the Drive to Run Mode .....	2-23
Magnetek AC Drive Introduction .....	2-24
Digital Operator .....	2-24
Keypad Operation .....	2-24
Clear Fault .....	2-24
Magnetek Drive Operation Overview .....	2-25
Operator (HPV600/600PM/900/900PM) .....	2-25
Operator (HPV 900II) .....	2-25
Cover (HPV 900/900PM) .....	2-26
Drive Motor/Encoder Setup Overview .....	2-26
Auto-tuning AC Motors to the Magnetek Drive .....	2-27
Tuning Motor No-Load Current (HPV 600/900/900II Only) .....	2-27
Tuning Motor Flux Saturation Curve (HPV 600/900/900II Only) .....	2-27
Tuning Motor Rated RPM (HPV 600/900/900II Only) .....	2-27
Determining System Inertia .....	2-27
The Drive Manual .....	2-27
<b>Set Up for Construction Operation</b> .....	<b>2-28</b>
Minimal Requirements .....	2-28
Jumper Requirements .....	2-28
Bypassing Faults on Inspection .....	2-29
Resolving Faults .....	2-29
Speed and Acceleration Control .....	2-30
Required Drive Parameter Settings .....	2-31
Torqmax F5 AC Drive Parameters .....	2-31
Magnetek AC Drive Parameters .....	2-36
Required Controller Parameter Settings .....	2-44
Acceleration and Deceleration Rates .....	2-44
Curves Used for Operating Speeds .....	2-44
The F7 Menu .....	2-45
Important .....	2-45
Changing Parameters .....	2-45
Next .....	2-45
Select .....	2-45
Change .....	2-45
Move Back .....	2-45
Saving Changes .....	2-45

Controller Motion Parameters .....	2-46
Using Inspection Stations to Run .....	2-47
Encoder Polarity (KEB, TorqMAX) .....	2-47
Align Encoder (Magnetek) .....	2-47
HPV 600/900/900II .....	2-47
HPV 600PM .....	2-47
HPV 900PM .....	2-48
Brake Basics .....	2-48
Verify Motor Speed, KEB/TorqMAX .....	2-49
Verify Motor Speed, Magnetek .....	2-49
Temporary Run Box Hookup .....	2-50
<b>Prepare for Inspection Operation .....</b>	<b>2-51</b>
Hoistway Safety String .....	2-52
Cartop Safety String .....	2-52
Hoistway Switches .....	2-52
Virtual/Physical/Unused .....	2-52
Seismic Equipment .....	2-53
<b>Running on Inspection Mode .....</b>	<b>2-54</b>
Controller Power Up .....	2-54
Bypassing Faults on Inspection .....	2-55
<b>Finishing Installation .....</b>	<b>2-55</b>
<b>Landing/Positioning System .....</b>	<b>2-56</b>
Safety String Connection Information .....	2-57
Recommendations .....	2-57
Installation .....	2-58
Tape End Pieces .....	2-59
Hanging Tape .....	2-60
Sensor Mounting .....	2-61
Configuration .....	2-67
Left to Right Rail Side Reversal .....	2-68
<b>Door Operator and Door Peripherals .....</b>	<b>2-71</b>
Door Safety Equipment .....	2-71
Door Switches .....	2-71
Car Operating Panels, Position Indicators, and Peripherals .....	2-71
Fire Service Peripherals .....	2-71
Duplex Connection Between Controllers .....	2-72
Hall Calls, Position Indicators, and Peripherals .....	2-72
CE Position Indicators .....	2-72
<b>Adjust Brake to 125% of Full Load .....</b>	<b>2-73</b>
<b>Traction Auxiliary Power Supply .....</b>	<b>2-73</b>
<b>Installation Review .....</b>	<b>2-74</b>

---

## Section 3. Final Adjustments

<b>In this Section</b> .....	<b>3-1</b>
<b>Basic Service Parameters</b> .....	<b>3-2</b>
<b>Learning Floor Levels &amp; Counterweight Position</b> .....	<b>3-2</b>
ELGO Encoded Magnetic Tape .....	3-2
Learn .....	3-3
Fill .....	3-4
LS-EDGE Steel Tape .....	3-4
Adjusting Floor Heights .....	3-5
Door Zone Verification .....	3-5
<b>Car and Counterweight Balance</b> .....	<b>3-6</b>
<b>Setting Motion/Position Parameters</b> .....	<b>3-7</b>
Often Used Procedures .....	3-7
How to check Car Speed: .....	3-7
How to place the car on Inspection Mode Fault Bypass: .....	3-7
How to place the car on Automatic Mode Fault Bypass:.....	3-7
How to access/set the F7 parameters:.....	3-8
How to Reset Excessive Faults .....	3-8
How to Register Calls from the Controller .....	3-9
<b>Setting Up Performance Curves</b> .....	<b>3-10</b>
Acceleration and Deceleration Rates .....	3-10
Curves Used for Operating Speeds .....	3-10
Profile Parameters .....	3-11
Typical Speed Profile Settings .....	3-12
Adjust for Drive Response .....	3-13
Tuning .....	3-14
Verify One Floor Run Operation .....	3-14
Verifying Contract Speed Operation .....	3-15
KEB/TorqMAX: .....	3-15
Magnetek .....	3-15
<b>Measuring NTS and ETS Switch Locations</b> .....	<b>3-15</b>
<b>Terminal Learn</b> .....	<b>3-17</b>
Verify F7 Speed Values .....	3-17
Set ETS Switch Delta Values .....	3-17
Set NTS Switch Delta Values .....	3-17
Adjustments .....	3-18
If an ETSL switch is required: .....	3-18
Short Floors Near a Terminal .....	3-18
Short Floor from 1 to 12-inches in Height .....	3-18
<b>Additional Adjustment</b> .....	<b>3-19</b>
Tuning (Magnetek) .....	3-19
Tuning Motor No-Load Current (HPV 600/900/900II) .....	3-19
Tuning Motor Flux Saturation Curve (HPV 600/900/900II) .....	3-19
Tuning Motor Rated RPM (HPV 600/900/900II) .....	3-19
Determining System Inertia (All Magnetek) .....	3-19
Relevel Operation .....	3-20
Brake Coordination .....	3-20
Run Tests .....	3-20

Adjustment Problems .....	3-20
Speed Changes Felt Excessively in Car .....	3-20
Loss of Control During Acceleration .....	3-20
Car Overshoots or KEB E.OL/E.OP or MAG Mtr Overload/Overvolt Flt .....	3-21
Car Oscillates at Contract Speed .....	3-21
<b>Placing Calls From the Controller .....</b>	<b>3-22</b>
If the car opens a Final Limit .....	3-22
If the car does not leave a landing .....	3-23
<b>Load Testing AC Drives .....</b>	<b>3-23</b>
Trouble Slowing with a Full Load .....	3-23
Electrical Noise .....	3-24
<b>Load Weigher .....</b>	<b>3-25</b>
Analog Voltage or Relay Closure .....	3-25
Installing the Sensors .....	3-26
Installation with 2 to 1 Roping .....	3-27
Installing the Control Unit .....	3-28
Analog Weigher Output Wiring .....	3-29
Relay Closure Output Wiring .....	3-29
Controls Overview .....	3-29
Menu Order .....	3-29
Calibration .....	3-30
Manual Calibration with Weights .....	3-30
Relay Setup .....	3-31
Controller Parameters .....	3-32
Auto-zero Calibration .....	3-33
Analog Weigher Additional Calibration .....	3-33
Verifying Empty Car Weight for Analog Weighers .....	3-33
Troubleshooting .....	3-34
<b>Final Tests .....</b>	<b>3-35</b>
Often Used Procedures .....	3-35
How to check Car Speed: .....	3-35
How to place the car on Inspection Mode Fault Bypass: .....	3-36
How to place the car on Automatic Mode Fault Bypass: .....	3-36
How to access/set the F7 parameters: .....	3-36
Important .....	3-36
How to Reset Excessive Faults .....	3-37
Safety String Test .....	3-38
SAFH Safety String Test .....	3-38
SAFC Safety String Test .....	3-38
Motor Contactor Proofing Test .....	3-38
Car Stopped at Floor .....	3-38
Car in Motion .....	3-38
Brake Contactor Proofing Test .....	3-39
Car Stopped at Floor .....	3-39
Car in Motion .....	3-39
Directional Limits Test .....	3-39
Down Direction Limit Test .....	3-39
Up Direction Limit Test .....	3-39

---

Final Limit Tests .....	3-40
Lower Final Limit Test .....	3-40
Upper Final Limit Test .....	3-40
Buffer Tests .....	3-41
(Car) Buffer Test .....	3-41
Inspection Overspeed Test .....	3-42
Contract Overspeed Test .....	3-42
Leveling Overspeed Test .....	3-42
Normal and Emergency Terminal Switch Tests .....	3-43
Outer NTS Delta High Speed Test .....	3-43
Outer NTS Delta Low Speed Test .....	3-43
Continued NTS/ETS Testing .....	3-44
ETS Testing .....	3-44
ETSL Testing .....	3-44
Electrical Governor Test .....	3-44
Ascending Car Overspeed Test .....	3-45
Safety Tests .....	3-45
Car Safety Test .....	3-45
Counterweight Safety Test .....	3-46
Emergency Brake Test - Unintended Motion, Rope Brake .....	3-47
Emergency or Standby Power Operation .....	3-53
Traction Auxiliary Power Supply Test .....	3-53
Mainline Disconnect Verification .....	3-53
TAPS and Controller Operation Verification .....	3-53
Backup Generator Power Test .....	3-54
<b>Final Adjustment .....</b>	<b>3-56</b>

---

## Section 4. User Interface

<b>In this Section</b> .....	<b>4-1</b>
<b>The HC-MPU Main Processor Unit</b> .....	<b>4-3</b>
<b>Access Security</b> .....	<b>4-5</b>
Password .....	4-5
<b>Setting Parameters To Default Values</b> .....	<b>4-5</b>
<b>Diagnostic Mode</b> .....	<b>4-6</b>
LCD Format .....	4-6
Troubleshooting Example .....	4-8
<b>F1: Program Mode</b> .....	<b>4-11</b>
General Description of Program Mode .....	4-11
Changing Parameters .....	4-11
Saving Changes .....	4-11
Viewing Options Within a Menu .....	4-12
Restoring Original Values Before Saving .....	4-12
Step-By-Step Example .....	4-12
Basic Features Menu .....	4-13
Fire Service Menu Options .....	4-16
Door Operation Menu Options .....	4-18
Timer Menu Options .....	4-23
Gongs/Lanterns Menu .....	4-25
Spare Inputs Menu .....	4-26
Viewing and Assigning Spare Inputs .....	4-26
Spare Outputs Menu .....	4-35
Viewing and Assigning Spare Outputs .....	4-35
Extra Features Menu Options .....	4-42
Additional Car Options .....	4-49
<b>F2: External Memory Mode</b> .....	<b>4-50</b>
Example .....	4-50
<b>F3: System Mode</b> .....	<b>4-53</b>
Building Security Menu .....	4-53
Viewing The Building Security Menu .....	4-54
Programming And Viewing The Security Codes .....	4-54
Controller System Menu .....	4-55
Passcode Request Menu .....	4-56
Entering the Passcode .....	4-56
Activating the Passcode .....	4-57
Load Weigher Thresholds .....	4-57
Adjusting Thresholds .....	4-58
To adjust thresholds .....	4-58
Analog Load Weigher Learn Function .....	4-58
<b>F4: Messages and Floor Labels</b> .....	<b>4-60</b>

<b>F5 Menus</b> .....	<b>4-61</b>
Controller Utilities .....	4-62
Car Call Registration .....	4-62
Date/Time, View / Adjust .....	4-63
View Event Log .....	4-63
Clear Event Log .....	4-63
Default TC-MPI Parameters .....	4-63
MPI Diagnostic Menu .....	4-64
MPI-A Diagnostics .....	4-65
MPI-B Diagnostics .....	4-73
MPI-C Diagnostics .....	4-82
System CAN Bus .....	4-91
Monitoring and Reporting Menu .....	4-92
Diagnostics, Refresh, Reset .....	4-93
Terminal Limit Utilities Menu .....	4-95
FCL Brake Unit Utilities Menu .....	4-96
FCL Diagnostic Menu .....	4-96
FCL Power Data Menu .....	4-96
Default TC-FCL Parameters .....	4-96
FCL Adjustment Menu .....	4-96
<b>F6: Hoistway Learn Operations</b> .....	<b>4-97</b>
ELGO Encoded Magnetic Tape .....	4-97
Learn .....	4-97
Fill .....	4-98
LS-EDGE Steel Tape .....	4-98
Adjusting Floor Heights .....	4-99
<b>F7: Parameters Adjust</b> .....	<b>4-100</b>
Important .....	4-100
Changing Parameters .....	4-100
Next .....	4-100
Select .....	4-100
Change .....	4-100
Move Back .....	4-100
Saving Changes .....	4-100
Controller Parameter/Drive Parameter Interaction .....	4-101
Using ID Numbers for Direct Parameter Access .....	4-102
Parameters .....	4-108
Floor Heights .....	4-108
Bottom Access Distance, 65 .....	4-108
Top Access Distance, 66 .....	4-108
Counterweight Position, 67 .....	4-109
Directional Limit Distance, 68 .....	4-109
Terminal Switch Options, 69 - 74 .....	4-109
Speed Related Parameters .....	4-111
UETS Speed, 75 .....	4-111
UETS Distance, 76 .....	4-111
UETS Delta Distance, 77 .....	4-111
UETS Delta Speed, 78 .....	4-111
Reduced Stroke Buffers .....	4-111

Normal Terminal Switch Parameter Explanations .....	4-112
UNTS1 Speed, 79 .....	4-113
UNTS1 Distance, 80 .....	4-113
UNTS1 Delta Distance, 81 .....	4-113
UNTS1 Delta Low Speed, 82 .....	4-113
UNTS1 Delta High Speed, 83 .....	4-113
UNTS2, 3, 4, 5 .....	4-113
DETS Speed, 104 .....	4-114
DETS Distance, 105 .....	4-114
DETS Delta Distance, 106 .....	4-114
DETS Delta Speed, 107 .....	4-114
DNSTS1 Speed, 108 .....	4-114
DNSTS1 Distance .....	4-114
DNSTS1 Delta Distance, 110 .....	4-114
DNSTS1 Delta Low Speed, 111 .....	4-114
DNSTS1 Delta High Speed, 112 .....	4-114
DNSTS2, 3, 4, 5 .....	4-115
Brake Pick Delay, 133 .....	4-115
Speed Pick Delay, 134 .....	4-115
Brake Hold Delay, 135 .....	4-116
Brake Drop Delay, 136 .....	4-116
Drive Disable Delay, 138 .....	4-116
Speed Hysteresis Delay, 139 .....	4-116
Profile Advance, 140 .....	4-116
Profile Scale, 141 .....	4-116
Standard Slew Slope, 142 .....	4-116
Danger Slew Slope, 143 .....	4-116
Slew Filter, 144 .....	4-116
Contract Overspeed, 145 .....	4-117
Inspection Overspeed, 146 .....	4-117
Leveling Overspeed, 147 .....	4-117
Hoist Motor Speed, 148 .....	4-117
Contract Speed, 149 .....	4-117
High Speed, 150 .....	4-117
Intermediate Speed, 151 .....	4-117
Earthquake Speed, 152 .....	4-117
Auxiliary Speed, 153 .....	4-118
Backup Power Speed, 154 .....	4-118
Inspection Speed (Normal), 155 .....	4-118
Inspection Speed (Reduced), 156 .....	4-118
Correction Speed, 157 .....	4-118
Leveling Speed, 158 .....	4-118
Re-Leveling Speed, 159 .....	4-118
Leveling Distance, 160 .....	4-118
Re-Leveling Distance, 161 .....	4-118
Proximity Distance, 162 .....	4-118
Leveling Dead Zone Distance, 163 .....	4-118
Standard Start Jerk, 165 .....	4-118
Standard Roll Jerk, 166 .....	4-118
Standard Stop Jerk, 167 .....	4-118
Standard Acceleration, 168 .....	4-119
Standard Deceleration, 169 .....	4-119
Manual Start Jerk, 170 .....	4-119
Manual Roll Jerk, 171 .....	4-119



---

Manual Stop Jerk, 172	4-119
Manual Acceleration, 173	4-119
Manual Deceleration, 174	4-119
Danger Start Jerk, 175	4-119
Danger Roll Jerk, 176	4-119
Danger Stop Jerk, 177	4-119
Danger Deceleration, 178	4-119
Alternate Start Jerk, 179	4-120
Alternate Roll Jerk, 180	4-120
Alternate Stop Jerk, 181	4-120
Alternate Acceleration, 182	4-120
Alternate Deceleration, 183	4-120
Drive Type, 184	4-120
Brake Type, 185	4-120
Emergency Brake, 186	4-120
Reduced Inspection Speed, 187	4-121
Unintended Motion, 188	4-121
Following Error, 189	4-121
Sheave Brake Idle Delay, 190	4-121
Landing System, 191	4-121
Speed Drop Delay, 192	4-121
Profile Compensation, 193	4-122
Normal Brake Pick Voltage, 194	4-122
Normal Brake Hold Voltage, 195	4-122
Normal Brake Relevel Voltage, 196	4-122
Normal Brake Lift Rate, 197	4-122
Normal Brake Drop Rate, 198	4-122
Emergency Brake Type, 199	4-122
Emergency Brake Pick Voltage, 200	4-122
Emergency Brake Hold Voltage, 201	4-122
Directional Limit Type, 202	4-123
F7 Settings Record	4-123
<b>F8: Software Revision</b>	<b>4-124</b>
Status Displays	4-124
<b>F1 &amp; F8: Board Software Versions</b>	<b>4-125</b>

---

## Section 5. Troubleshooting

<b>In This Section</b> .....	<b>5-1</b>
<b>Status and Error Messages</b> .....	<b>5-2</b>
<b>Duplexing</b> .....	<b>5-37</b>
Dispatching Algorithm .....	5-37
Hardware Connections .....	5-37
<b>PC Board Quick References</b> .....	<b>5-38</b>
HC-CHP CAN Hub and Power Supply Board .....	5-39
Connectors .....	5-39
Jumpers .....	5-39
Test Points .....	5-39
Indicators .....	5-40
Switches .....	5-40
SW1 DIP Switch Settings .....	5-40
HC-CTL Control Board .....	5-41
HC-MPU Main Processor Board .....	5-50
HC-MPU Battery .....	5-52
HC-RDR Rear Door Board .....	5-53
HC-UIO Universal Input/Output Board .....	5-57
Switches .....	5-57
Jumpers .....	5-57
Test Points .....	5-57
Indicators .....	5-58
Terminals .....	5-58
Call Inputs and Outputs .....	5-58
HC-UIO DIP SW1 Switches 7, 8 and 9 Settings .....	5-59
HC-UIO Used for Calls .....	5-59
Hospital Emergency Operation I/O .....	5-59
Spare Inputs and Outputs .....	5-60
MC-CPI Car Panel Interface Board .....	5-61
Installation Instructions .....	5-61
MC-CPI Board Details .....	5-63
Before Applying Power .....	5-65
MC-LSI Landing System Interface Board .....	5-66
LSI Connections .....	5-66
SC-3HN Three Input Serial Hall Call Node Board .....	5-67
Call Bus Conditions .....	5-67
General Installation .....	5-67
Addressing and CAN Bus Termination .....	5-69
Riser Assignment .....	5-69
Floor Number and Front or Rear Opening .....	5-69
Baud Rate .....	5-69
CAN Bus Termination .....	5-69
On Board Diagnostics .....	5-70
ON LED .....	5-70
(FLT) FAULT LED .....	5-70
TC-MPI Board .....	5-71

---

<b>Motion Brake Module</b> .....	<b>5-76</b>
Configuration .....	5-76
Switches and Jumpers.....	5-77
Reset Switch .....	5-78
Jumper JP1.....	5-78
ON LED.....	5-78
Module Connectors Per Board .....	5-79
Top Board, TC-FCL .....	5-79
J4, J5.....	5-80
J3 .....	5-80
J6 .....	5-80
Middle Board, TC-LPS .....	5-80
Bottom Board, TC-FCP .....	5-80
Calibration (CAN Only).....	5-82
Trim pots and Function (Discrete Control Only).....	5-82
Setup for Adjustment .....	5-82
Discrete Control Adjustment .....	5-83
CAN Control Adjustment .....	5-83
Only if a Manual Brake Pick Button is Used with CAN Control.....	5-84

## Section A. Appendix

<b>In this Section</b> .....	<b>A-1</b>
<b>KEB F5 Parameters Table</b> .....	<b>A-2</b>
<b>Magnetek Parameters Table</b> .....	<b>A-6</b>
<b>F7 Settings Record</b> .....	<b>A-14</b>
<b>General Settings Log</b> .....	<b>A-21</b>
<b>Customer Notations</b> .....	<b>A-27</b>
<b>R6 Regenerative Drive Reference</b> .....	<b>A-28</b>
<b>Manual Floor Setup</b> .....	<b>A-29</b>
F7 Entry .....	A-29





**Motion Control Engineering®**

A Kinetek Company®

## *Motion 4000 Traction Elevator Control*

---

### **In this section**

This section provides a general description of the Motion 4000 Traction Elevator Control, including:

- **Controller Overview.**  
Please refer to “Motion 4000 Traction Elevator Control Overview” on page 1-2.
- **System Features.**  
Please refer to “System Features” on page 1-3.
- **Component Descriptions.**  
Please refer to “System Component Descriptions” on page 1-5.
- **Operating Mode Descriptions.**  
Please refer to “Operating Mode Descriptions” on page 1-9.
- **Monitoring and Control Options.**  
Please refer to “Monitoring and Control Options” on page 1-16.

## Motion 4000 Traction Elevator Control Overview

A Motion 4000 controller order may include:

- **Controller:** Configured according to customer job survey, field programmable.
- **Cartop station:** Interface between car-mounted equipment and the car controller.
- **Serial panel option:** Converts car panel analog button data to serial data stream.
- **Optional CAN node boards and wiring for serial hall call.**
- **User Interface:** Standard, controller mounted keypad/LCD, optional hand-held keypad/LCD units to set controller parameters, optional mView PC application.

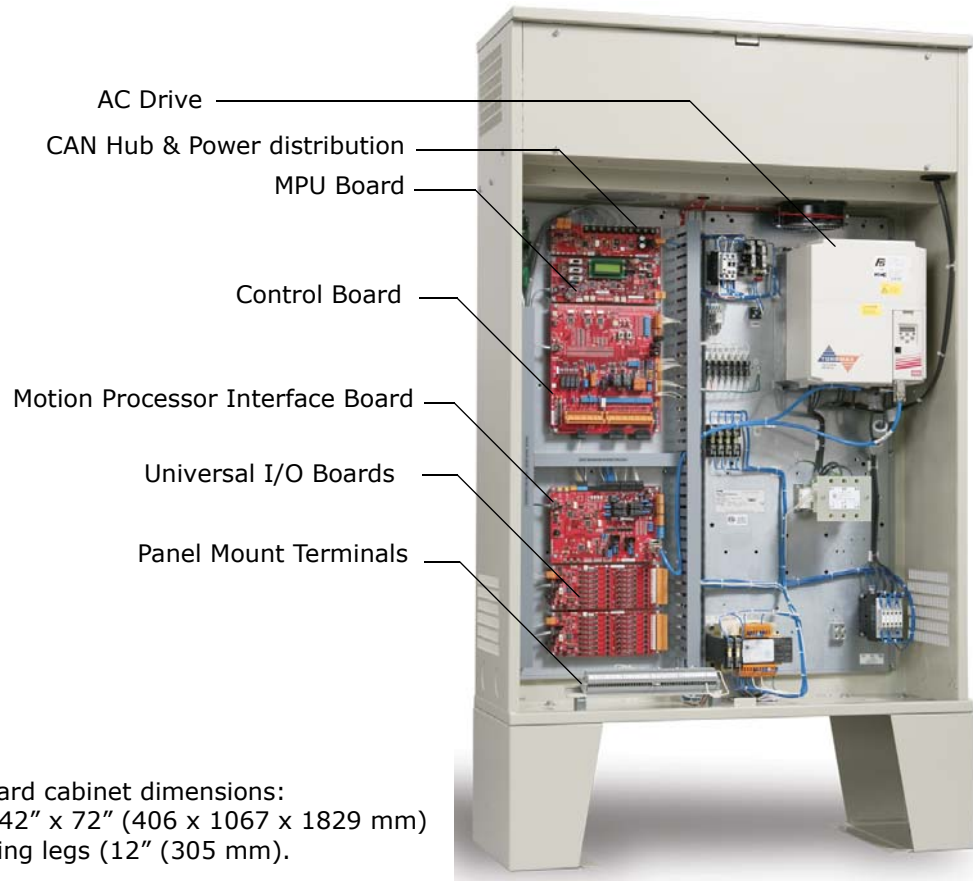

Standard cabinet dimensions:  
 16" x 42" x 72" (406 x 1067 x 1829 mm)  
 including legs (12" (305 mm).

**Table 1.1 Specifications**

Maximum car speed	450 fpm, 2.25 m/s
Configuration	Simplex, Duplex, Group up to 6 cars
Landings	32 landings, 64 openings maximum
Motor control	TorqMax F5, Magnetek HPV AC drives
Landing/Positioning system	Encoded magnetic tape or steel tape
Call Registration	Serial or Discrete COP, Discrete or serial (serial only with group dispatcher) Hall Call
Power requirement	208 – 600 VAC, 50/60 Hz, 3-phase
Environment	32 - 104° F, 0 - 40° C; Humidity 95% non-condensing
*Standard enclosure (includes legs)	42" w x 72" h x 16" d (1067 x 1829 x 406 mm) with knock-outs
Available NEMA enclosures	NEMA 4, 4X, 12
* Variations available	

## System Features

Motion 4000 design incorporates:

- Solid state implementation of redundancy and proofing requirements, eliminating relays whenever possible to improve service life and reliability.
- Retention of the simple LCD/keypad programming interface used on earlier MCE programmable controls but with the addition of a hand-held interface (mPAC) that can be plugged in to any system CAN connector.
- Easy software updates — Internet download through a PC to the hand-held user interface, MCE SD card, or EEPROM replacement.
- CAN Bus: Circuit boards and major components all communicate through light weight, serial CAN Bus connections. Communication between major system components (i.e., controller to car, controller to hall calls, etc.) uses shielded, twisted-pair cables connected to pluggable terminals (CAN).
- ASME A17.1/CSA B44 compliant throughout.
- Field connections: Field connections are handled by Universal I/O boards. The boards are factory set to handle 24V, 48V, 110V, or 120V AC or DC inputs. This allows a single board design to service all common inputs.
- Positioning: Permanently encoded magnetic tape, or steel tape positioning systems.
- Minimized hoistway peripherals: Motion 4000 design allows slowdown, emergency terminal, and hoistway access limit switches to be eliminated. These switches exist as virtual switches in system software.
- Serial hall call: Motion 4000 systems with central dispatching may use a serial hall call system for easier field wiring. The riser drop provides CAN communication and power to the fixtures. (Discrete hall call wiring is supported through Universal I/O boards.)
- Serial car panel option: Discrete signals from car panel buttons may be serialized for easy connection to the controller via CAN bus through the cartop interface.
- Light weight traveler and hoistway cabling: Serial communication allows low traveler and hoistway cable conductor counts.
- Optional monitoring capabilities using mView, iMonitor, and iReport software.
- Optional integration with Building Management Software using BMS-LINK.
- Optional Jail Services application for detention center operation.
- (MRL) Optional passenger rescue system provides input from a cartop mounted camera and a rescue control panel with LCD display to allow a technician to safely drift the car to a landing in the absence of commercial or emergency power. Once at the landing, doors must be opened manually.
- Optional Traction Auxiliary Power Supply (TAPS) provides automated return of the car to a landing and automated door opening in the absence of commercial power. Power is provided via an integrated UPS/battery system and requires no generator.



### Note

If the job uses a TAPS system and a TorqMax/KEB F5 drive, drive parameter LF.61 must be set to Di1.

Figure 1.1 Functional Block

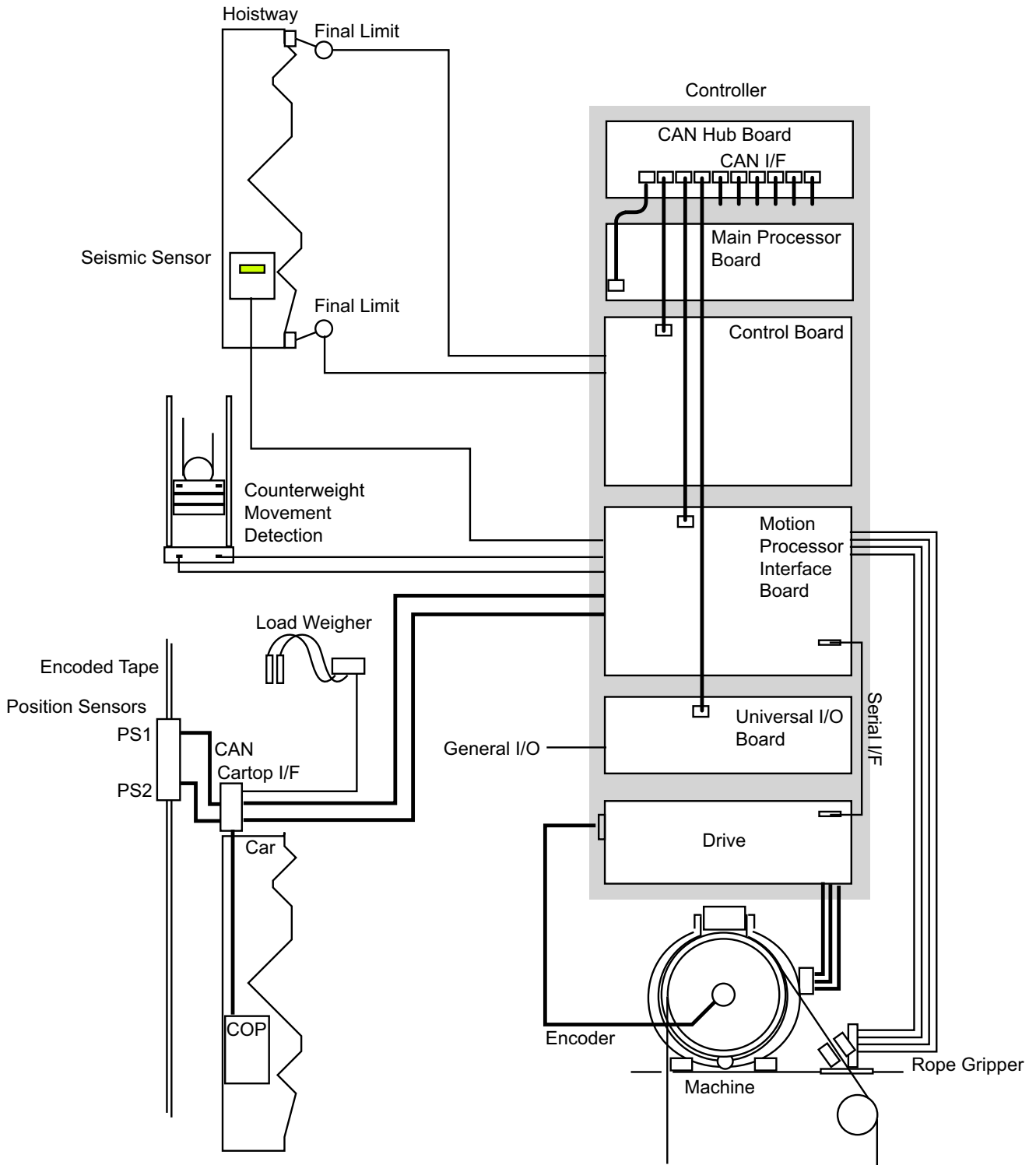



## System Component Descriptions

- Controller boards and hand-held user interface
- Car mounted equipment, [page 1-6](#)
- Hoistway equipment, [page 1-8](#)

### Controller Circuit Boards

Circuit boards used depend upon job requirements. Typically, the following boards are used:

- **HC-CHP, CAN Hub and Power Supply:** Provides ~18-volt, 4-amp DC power for circuit boards in the controller and a central connection point for the Controller Area Network (CAN).
- **HC-MPU, Main Processing Unit:** Fitted with the appropriate software, performs control data processing. The HC-MPU is responsible for:
  - Car operation
  - Fire Service
  - Programming and diagnostics
  - Software validation
  - Duplexing / Group communication
- **HC-UIO, Universal Input/Output Board:** HC-UIO boards are used for field inputs and outputs. The boards are universal in that they can be configured for AC or DC inputs from 24 to 120 Volts.
- **TC-MPI, Motion Processor Interface Board:** Configured to interface to the drive selected for the job. Handles machine and brake contactors, position system I/O, earthquake/seismic and emergency brake/rope gripper requirements.
- **HC-CTL, Control Board:** Monitors I/O, performs safety functions, front door operation, and machine room inspection. The HC-CTL board is responsible for:
  - Inspection
  - Test operation
  - Diagnostic Flags
  - Front Hall and Car Door Lock Bypass
  - Lanterns and Gongs
  - Spare I/O

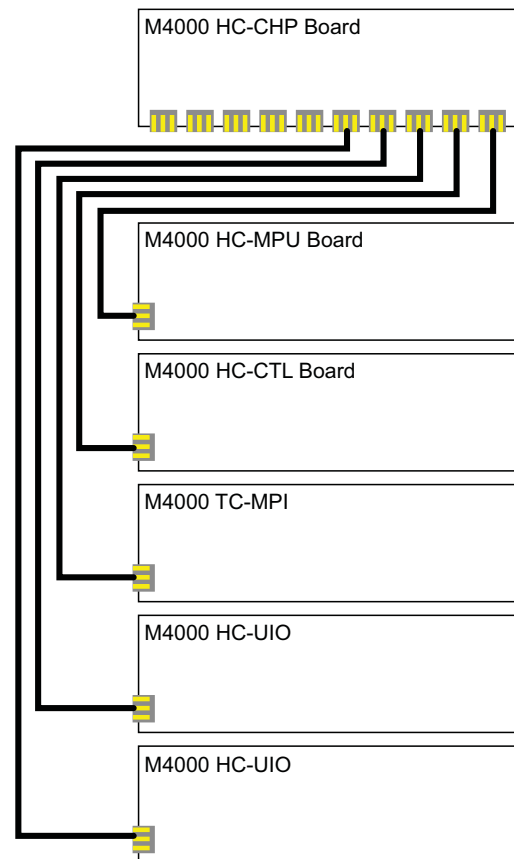

Additional circuit boards may be used, including:

- **Rear Door board:** Second door operator interface board.
- **CE Fixture board:** Used with external, serially controlled position indicator and annunciator fixtures.

### Hand-Held User Interface

The hand-held user interface, mPac, provides a portable interface and a means to upload new firmware to the system. The hand-held can be plugged in to a CAN connection in the controller, on the cartop, or in the car (if one is wired).

### Car

#### Landing and Positioning

Motion 4000 uses one of two landing systems; encoded magnetic tape or perforated steel tape and magnets.

The ELGO encoded steep tape system uses a 1/2-inch wide, Gray code, magnetically encoded tape and two, independent sensor heads (in a single housing) for absolute position control under all powered conditions. The tape provides a unique code for every 1mm of travel. In addition to position, simple distance-over-time calculation provides extremely accurate speed feedback. A third, also independent system provides speed feedback directly from the hoist motor.

The LS-EDGE positioning system uses hall-effect sensors and perforated steel tape to report position as the car moves through the hoistway. 5.5-inch magnets are used at each door zone; one row for front openings, a second for rear openings. The system auto-corrects at each door zone to prevent error accumulation.

The system uses capacitor-stored power and non-volatile memory to retain position information in the event of a power failure, continuing to capture information for 22 seconds after power loss and storing the final reading for use after power restoration. Mechanical final limit, ETS, and ETSL switches are used but normal terminal switches may be virtual, existing only in system software, or mechanical depending upon specific controller capabilities. The LS-EDGE system may be used with MCE iControl or Motion 4000 elevator controls.



**Load Weigher**

Motion 4000 may use an EMCO rope strain gauge for load weighing. The controller uses the load weigher input to determine overload conditions and also in conjunction with car call registrations and photo-eye information to make anti-nuisance related decisions.

Figure 1.2 EMCO Load Weigher

1

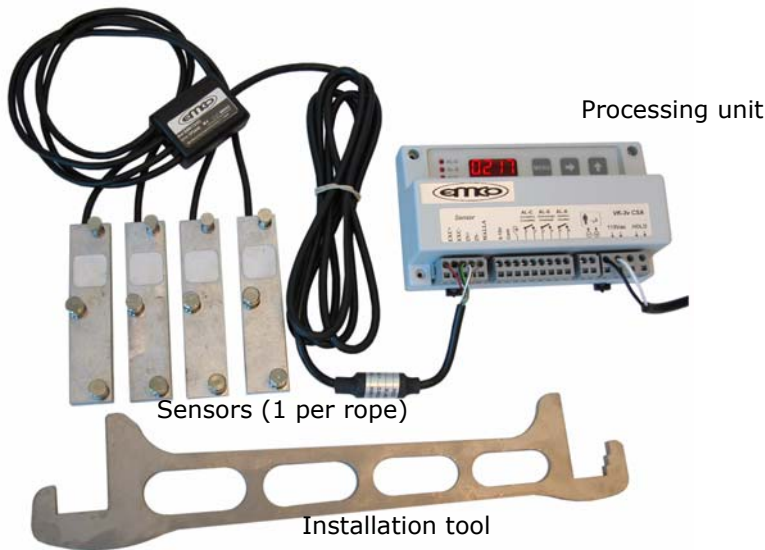

**Cartop Box**

A typical Motion 4000 cartop box is pictured below.

Figure 1.3 Motion 4000 Cartop Box

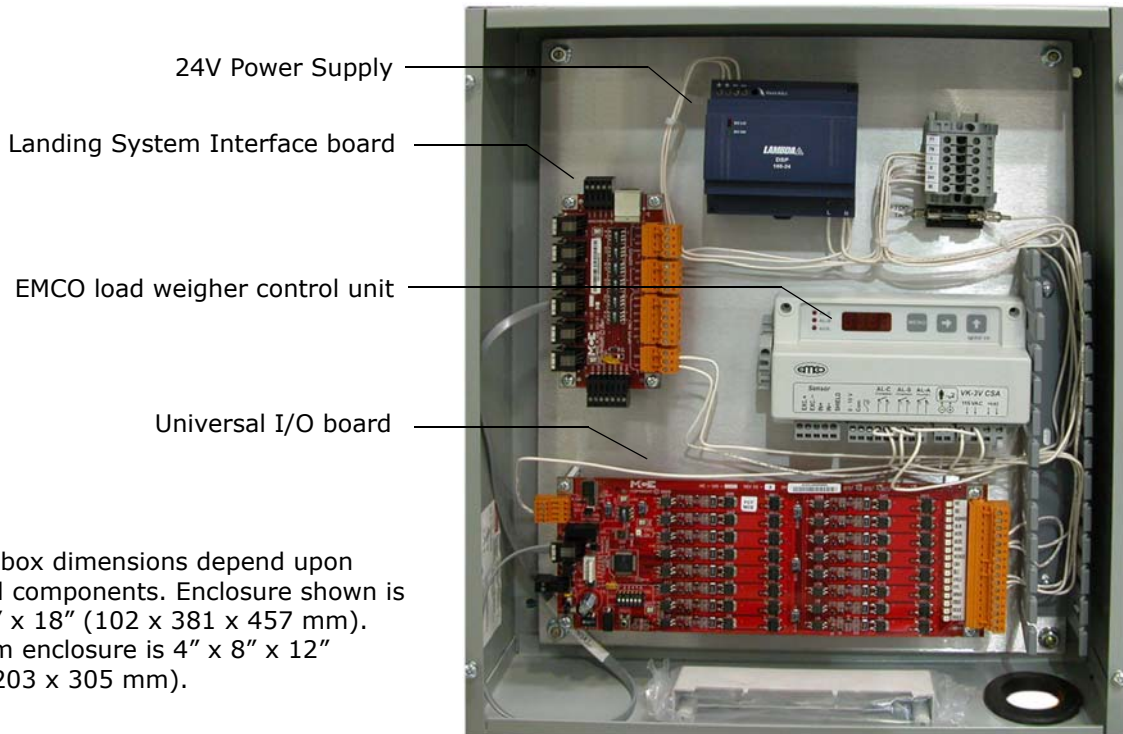

Car top box dimensions depend upon required components. Enclosure shown is 4" x 15" x 18" (102 x 381 x 457 mm). Minimum enclosure is 4" x 8" x 12" (102 x 203 x 305 mm).

## Hoistway

For serial hall call, Motion 4000 communicates with hall calls and similar buttons or key switches through an independent CAN Bus for reliability and easy installation. The hall bus provides a CAN signal path and 24 V power for the fixtures.

An SC-3HN three-input hall node board allows discrete hall call buttons and indicators to be connected along a CAN bus to provide serial hall call capability for Motion 4000, greatly reducing the number of conductors necessary in hoistway wiring bundles. [Please refer to “SC-3HN Three Input Serial Hall Call Node Board” on page 5-67.](#)

Discrete hall calls are supported using HC-UIO Universal I/O boards. [Please refer to “HC-UIO Universal Input/Output Board” on page 5-57.](#)

## Motion 4000 Specific Traveler Cable

Special traveler cable for Motion 4000 installations is available from MCE. The cable is sized and labeled to make controller to car connections as simple as possible. MCE PN# 44-03-0034.

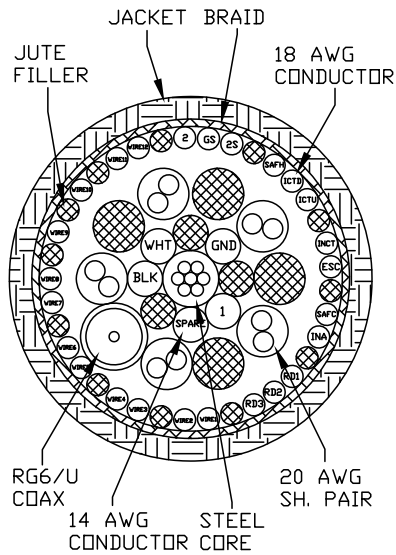

## Operating Mode Descriptions

Available operating modes are configured when the car is installed. Not all modes are available on all cars. This section describes operating modes, including:

- Normal Operation
- [Inspection Operation](#) (cartop, in-car, access, machine room)
- [Attendant Operation](#)
- [Independent Operation](#)
- [Sabbath Operation](#)
- [Emergency Medical Operation](#)
- [Hospital Operation](#)
- [Seismic Operation](#)
- [Fire Operation](#)
- [Emergency Power Operation](#)
- [Car Recall](#)
- [Capture for Test](#)
- [Test Mode](#)

### Normal Operation

Normal operation is the default elevator operating mode. In this mode, cars are accepting hall calls and servicing car calls as determined by Basic Features Menu and other operating menu selections. [Please refer to “Basic Features Menu” on page 4-13.](#) Cars are running at contract speed as affected by short or multi-floor run performance curves.

### Inspection Operation

In inspection, a car operates at the set inspection speed using continuous pressure up and down buttons or switches. The car will stop as soon as the buttons are released. Inspection operation may be controlled from four locations. For safety purposes, locations have a priority:

- Cartop
- In-Car
- Access
- Machine Room Inspection

#### Cartop Inspection

In this mode, the car is operated by pushing the cartop UP or DOWN and ENABLE buttons simultaneously. These buttons are generally provided through a third-party inspection station wired to inspection operation inputs in the elevator controller. There will also be a key switch that enables/disables inspection operation.

#### Mode Entry

- Bring the car to the access floor
- Enable hoistway access operation using the in-car switch
- Move the car down using the hall controls until the access limit is opened
- Set the cartop switch to Inspection and access the cartop.
- Use ENABLE and UP or DOWN buttons to run the car from the cartop.

### In Car Inspection

In this mode, the car is operated using a locked subpanel in the COP that provides the inspection key switch and direction buttons. (Top and bottom car call buttons may be used as direction buttons as well.)

#### Mode Entry

- Bring the car to the desired floor.
- Place the car on in-car inspection.
- Use UP or DOWN buttons to run the car.

### Hoistway Access Inspection

Hoistway access operation allows workers to access the top and bottom of the car from designated floors. In this mode, the car is brought to an access floor where a key switch is used to move the car up or down.

#### Mode Entry

- Bring the car to the access floor
- Place the car on hoistway access using the in-car switch.
- Move the car using the hall way switch until the access limit is opened
  - Top access must prevent the car from moving down beyond the point where the cross-head is even with the hoistway entrance sill.
  - Bottom access must prevent the car from moving up beyond the point where the bottom of the toe guard is even with the hoistway entrance header

### Machine Room Inspection

In this mode, the car is operated using switches on the HC-CTL (Control) board in the controller.

#### Mode Entry

- Place the car on Machine Room Inspection (Mode Switch to Inspection).
- Ensure that car and hoistway doors are closed and locked.
- Run the car using the ENABLE and UP or DOWN Directional switch positions.

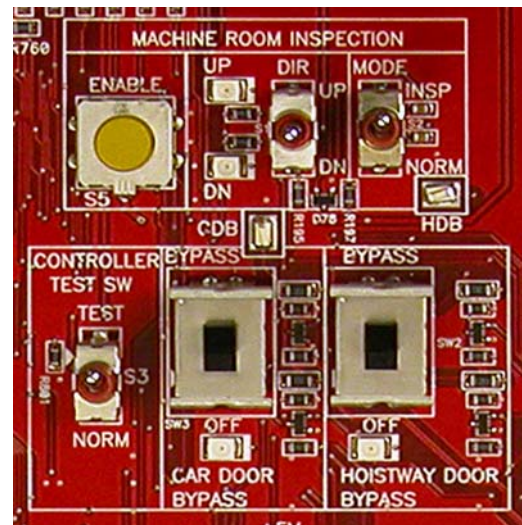

## Attendant Operation

Attendant operation allows an operator riding in the car to run the car, choosing run direction, and which hall calls to answer. In this mode:

- Doors open automatically when the car is stopped in a door zone.
- The attendant closes the door by pressing and holding the door close button, a car call button, or either car direction (UP/DOWN) button (UPI/DNI input: [Please refer to “Spare Inputs Menu” on page 4-26.](#))
- The attendant chooses the direction using run up (UNI) or down (DNI) buttons.
- The car will stop at the next car or hall call in the direction of travel. Holding the bypass button (NSI input) in will cause hall calls to be bypassed until the button is released. An annunciator panel is required if in-car visibility of hall calls is required.
- The elevator will level into the destination floor automatically, then open its doors.
- During Attendant operation, load weigher inputs are ignored.

### Mode Entry

- Call the car to a floor.
- Enter the car and activate the Attendant mode key switch (enables the ATS, Attendant Service, controller input).

## Independent Service

In this mode:

- The car is removed from hall call dispatching
- Doors open automatically when the car is stopped in a door zone
- The operator presses and holds the door close button to close doors
- The operator chooses direction and initiates the run by placing car calls (first placed determines direction of run).
- The elevator will level into destination floors automatically and open its doors.
- Hall arrival lanterns or jamb mounted arrival lanterns are inoperative.

### Mode Entry

- Call the car to a floor.
- Enter the car and activate the Independent mode key switch (IND input HC-CTL board).

## Sabbath Operation

Sabbath operation is a special mode that sets the car to consecutively service specified landings (and openings if the car has front and rear doors) during up and down travel with no hall or car call buttons being pressed. The car will begin from the bottom of the hoistway, travelling up and stopping at each designated stop and opening its doors to allow exit or entry. When the doors close, the car will travel to the next designated stop up the hoistway and repeat door operation. This will continue until the car reaches the top designated stop, at which point it will travel down the hoistway operating in the same manner.

- **Initiate:** Sabbath operation is initiated when the spare input SAB is activated.
- **Operation:** In accordance with the description above and servicing stops set through the Sabbath Operation parameter in the Extra Features menu. [Please refer to “Extra Features Menu Options” on page 4-42.](#)

## Emergency Medical Operation

This mode complies to Massachusetts code. It allows a car to be recalled to a floor where it can be boarded by medical personnel and placed in restricted service, using an in-car switch, to respond to a medical emergency.

- **Recall:** Initiated using a key switch (EMSH input) at the floor assigned by the Massachusetts EMS Service/EMS Service Floor parameter in the Extra Features menu (single switch, single floor).
  - The car will immediately cancel all registered calls, return to the designated floor, and open its doors.
- **In-Car Medical:** Medical personnel board the car and place it in hospital service using the in-car switch (EMSC input).
  - If the hall switch has been shut off, the car will wait sixty seconds then return to normal service if the in-car switch has not been activated.
  - If the hall switch remains on, the car will wait without restriction until the in-car switch is activated.



## Hospital Service

Please refer to “[HOSPITAL EMERG. OPERATION?](#)” on page 4-45. Hospital service allows a car to be recalled to any of one or more assigned floors using a call button at the floor. Once at the floor, the car may be boarded by medical personnel and placed in restricted service, using an in-car switch, to respond to a medical emergency.

- Recall: Floors and openings (if the car has front and rear doors) are designated as hospital service through Hospital Emerg Operation parameters in the Extra Features Menu. Please refer to “[Extra Features Menu Options](#)” on page 4-42. When a designated call button is activated, the car will recall to the floor.
  - The car will immediately cancel all registered calls, move to the call floor, and open its doors.
  - A Timer Menu function, Hospital Emergency Timer, allows a timer to be set for a range of up to 10 minutes. After a car recalls to the designated floor, it will remain there until the timer expires, after which it will return itself to automatic passenger service if the in-car, hospital service switch has not been activated.
- Operation: Once the in-car switch (HOSP input assigned through the Spare Inputs Menu) is activated, the car is in restricted service and will accept only calls assigned through the car operating panel.
- When the in-car switch is deactivated, the car returns to normal service.

## Seismic Operation

Please refer to “[EARTHQUAKE OPERATION?](#)” on page 4-48. Seismic operation is entered into automatically if counterweight derailment is detected (CWI input) or if the seismic sensor input (SSI) is activated. If the CWI input is triggered, the car comes to a full stop, moves at reduced speed (150 FPM or less) to the nearest floor in the direction away from the counterweight, levels, opens its doors to allow passengers to exit, then shuts down. For Torqmax/KEB drives, earthquake run speed is determined by drive parameter LF.45.

If only the SSI input is activated, ASME code allows the car to return to automatic operation at reduced speed.

### Mode Exit

- After ensuring that the hoistway is clear and all equipment is undamaged and operating properly:
  - Press the EQ Reset button on the Motion Processor Interface (MPI) board.

### Modifiers

Some fire codes allow the car to be run in fireman service even though the CWI or SSI input has been activated.

Note



Earthquake operating profile overrides the Emergency power profile.

## Fire Service Operation

There are many different fire codes that restrict or change elevator operation under fire conditions. [Please refer to “Fire Service Menu Options” on page 4-16.](#) In general, fire service proceeds in two stages; Phase I Fire Recall and Phase II Fire In-Car Operation. When a fire sensor or switch is activated:

- The elevator will recall to the designated main or alternate recall floor. (Main if fire detected on any floor other than the main floor; Alternate if fire detected on the main recall floor. Or, as directed by a manually activated Fire switch.)
- The elevator will open its doors to allow any passengers to exit, then remain at the recall floor until the in-car firefighter switch is activated. Once the in-car switch is activated the car will run on Fire Phase II operation as allowed by the selected fire code.

## Emergency Power Operation

[Please refer to “EMERGENCY POWER OPERATION?/EMERGENCY POWER RETURN FLOOR” on page 4-42.](#) Emergency or standby power operation requires a backup power source. For large buildings, this is typically a diesel or gasoline powered generator. When this is not practical, backup power for a limited, rescue operation may be provided by a battery-powered system like the MCE TAPS (Traction Auxiliary Power Supply).

### Generator Backup

When power is lost, the elevator will come to a full stop. When emergency/backup power comes on line, the elevator will be moved at programmed speed to a designated recall floor and the doors will open to allow passengers to exit. The elevator will remain at the recall floor unless it is designated to run under generator power.

### TAPS Backup

When power is lost, the elevator will come to a full stop. When battery power becomes available, the elevator will be moved at reduced speed to the nearest floor in the direction determined by TAPS settings. At the floor, the doors will cycle, allowing passengers to exit, and then close. The car will remain out of service until commercial power is again available and the TAPS unit switches the car from battery power back to normal power. Please refer to the MCE TAPS manual or data sheets for detailed information.

## Car Recall

Inputs may be provided to allow the car to be recalled to a specified floor.

- CTF: Car To Floor - This is a “spare” input that may be assigned to the HC-CTL board or to a Universal I/O board as configured for the job. The floor to which the car is returned is set by the Car to Floor Return Floor parameter in the Extra Features menu. [Please refer to “Extra Features Menu Options” on page 4-42.](#)
  - When activated, causes the car to stop responding to hall calls. Existing car calls will be serviced before or after recall depending on the setting of Retain Calls (see note below). New car calls will not be registered.
  - At the return floor, the car will open then close its doors and remove itself from service.
- CTL: Car to Lobby - This is a “spare” input that may be assigned to the HC-CTL board or to a Universal I/O board as configured for the job. The floor to which the car is returned is set using the Lobby Floor parameter in the Basic Features menu. [Please refer to “Basic Features Menu” on page 4-13.](#)
  - When activated, causes the car to stop responding to hall calls. Existing car calls will be serviced before or after recall depending on the setting of Retain Calls (see note below). New car calls will not be registered.
  - At the lobby floor, the car will open then close its doors and remove itself from service.



### Note

RETAIN CALLS?: There is a function in the Extra Features menu that determines if registered car calls are serviced before or after recall. [Please refer to “RETAIN CALLS ON CTL / CTF?” on page 4-48.](#)

## Capture for Test

CTST: Capture for Test - This is a “spare” input that may be assigned to the HC-CTL board or to a Universal I/O board as configured for the job.

- When this input is activated, the car will stop responding to hall calls and disable its gongs but continue to service car calls.
- The intent of the input is to allow maintenance personnel to capture the car while causing as little disruption to service as possible.

## Test Mode

Test mode allows the car to be run on automatic operation without operating the doors. When Test mode is active, door opening circuitry is deactivated and hall calls will not be registered.

- Enter Test mode by placing the TEST/NORMAL switch on the HC-CTL board in the TEST position. (The car will not enter Test mode if Inspection is active.)
- When Test mode is active, the controller LCD will display TEST MODE.

## Monitoring and Control Options

Motion 4000 is Ethernet capable, allowing it to use iMonitor and iReport applications for local and/or distance monitoring and control or report generation, archival, and automated alert. Motion 4000 can be linked to Building Management System software through MCE BMS-Link, providing system visibility and limited control. A machine room-only monitoring and control application, mView, is also available.

### iMonitor

iMonitor is an elevator monitoring application that allows local or remote viewing and control of MCE elevator groups using a personal computer running the Windows XP or Windows 7 operating system. Because Motion 4000 controls are Ethernet capable, you can connect to them through a local area network or remotely through internet technology.

iMonitor provides a graphical representation of elevator groups, allowing their activity and status to be quickly and easily viewed. The user defines any number of "Connection Sets." Each Connection Set consists of up to fifty connections to elevator group dispatchers selected by the user.

When working in iMonitor, the user simply clicks on a Connection Set which automatically establishes communication with all groups in the set and displays their associated hoistways and cars on the computer screen. Practical viewing limits are established by the speed of the connections and the size of the monitor viewing area.

When connected through iMonitor, the user may register car and general, auxiliary, or special hall calls as desired, control many group security functions, and enable or disable certain elevator operating modes.

### iReport

iReport is a system logging and report generating tool that allows local or remote analysis of MCE elevator groups from a personal computer running the Windows XP or Windows 7 operating system and iReport client software. Because Motion 4000 controls are Ethernet capable, you can use iReport to connect to them through a local area network or remotely through internet/modem technology.

iReport consists of the iReport server and iReport clients. Motion 4000 group dispatchers may be connected to iReport directly through a local area network or they may be connected remotely through the internet. The group dispatcher provides iReport with hall call and car operating mode information. The individual car controllers provide iReport with event and fault notifications.

### BMS-Link

BMS-LINK allows MCE elevators and escalators to be viewed and monitored using Building Management Software. Control capabilities in keeping with management system software needs are provided.

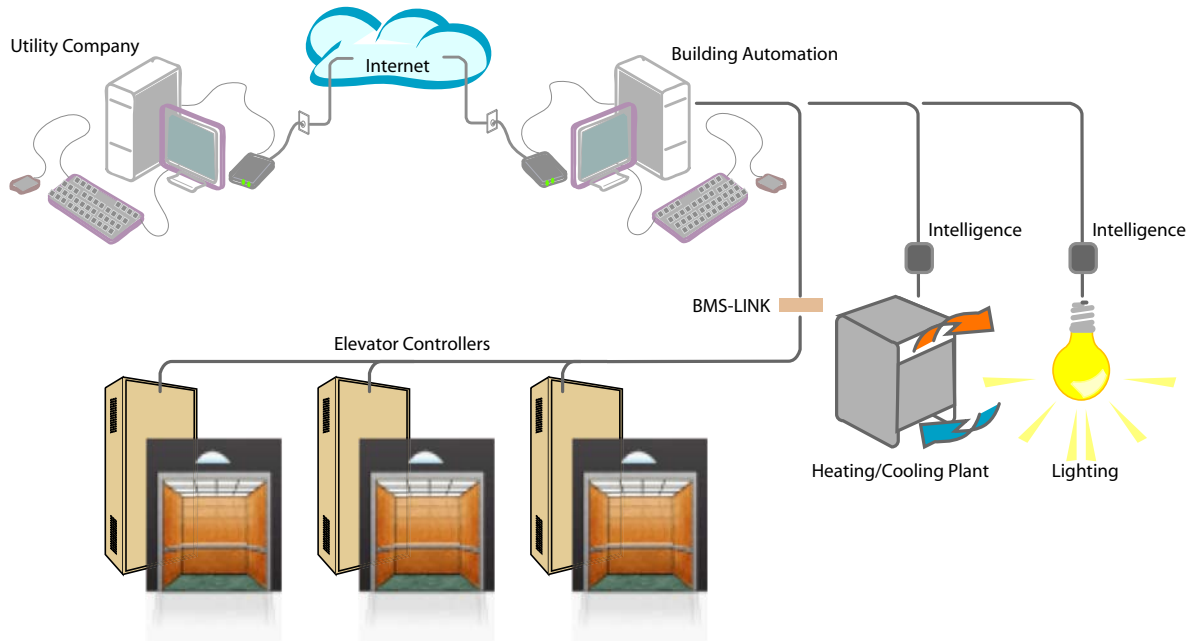

### mView

The mView application runs on a standard PC connected to the controller through an Ethernet hub or switch. mView provides local monitoring, status and event log viewing, diagnostics, and call registration for one or more Motion 4000 controllers.

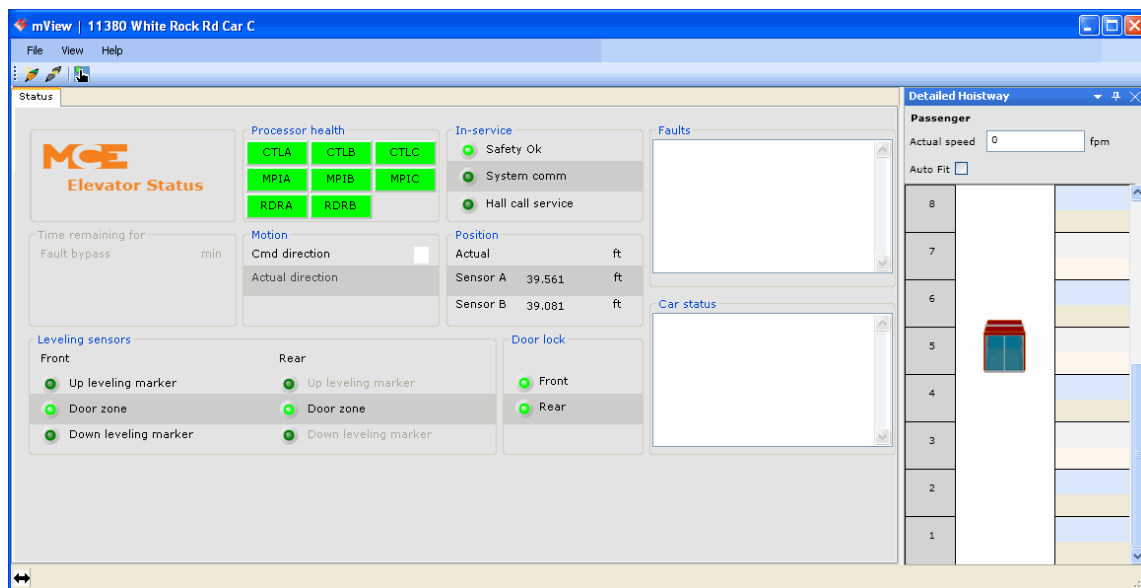





**Motion Control Engineering®**

A Kinetek Company®

*Installation*

---

## In this Section

This section contains instructions for installing the controller and peripheral equipment. If you are reading this on a computer, click the blue text to jump to the appropriate section.

- [Safety: page 2-2.](#)
- [Preparation: page 2-3.](#)
- [MCE Wiring Prints: page 2-5.](#)
- [Controller Installation: page 2-6.](#)
- [Connect AC power: page 2-10.](#)
- [Connect motor, brake, encoder: page 2-11.](#)
- [Emergency Brake/Rope Gripper installation: page 2-14.](#)
- [Initial Power Up: page 2-14.](#)
- [Auto-Tune Drive: page 2-17.](#)
- [Set up for Construction operation: page 2-28.](#)
- [Set up for Inspection operation: page 2-51.](#)
- [Running on Inspection: page 2-54.](#)
- [Finishing Installation: page 2-55.](#)
- [Installing the landing system: page 2-56.](#)
- [Adjust Brake: page 2-73.](#)
- [Traction Auxiliary Power Supply: page 2-74.](#)
- [Installation Review: page 2-74.](#)

The job prints are the primary document used to install the controller. The job prints and manual together provide information to install, adjust, and troubleshoot the controller. Study the job prints and read the manual before starting work. Call MCE with any questions.

Instructions in this section assume that the hoist ropes are attached to the car sling, all hoistway doors are closed, and that:

- The CAR SAFETY IS ADJUSTED to the manufacturer specification
- The GOVERNOR IS INSTALLED and the GOVERNOR ROPE CONNECTED to the safety

## Safety

Certain fundamental warnings must be kept in mind at all times to help avoid accidental death, severe personal injury, or equipment damage.

### Personal Safety

- Motion 4000 Controllers may only be installed by qualified, licensed, trained elevator personnel familiar with the operation of microprocessor-based elevator controls.
- Verify safety devices (limits, governors, hoistway locks, car gate, etc.) are fully functional before running the elevator. Never operate controls with any safety device inoperative.
- The user is responsible for complying with the current National Electrical Code with respect to the overall installation of equipment and proper sizing of electrical conductors.
- The user is responsible for understanding and applying all current local, state, provincial, and federal codes that govern practices such as controller placement, applicability, wiring protection, disconnections, over-current protection, and grounding procedures.
- Controller equipment is at line voltage when AC power is connected. Never operate controls with covers removed from drive or brake controls.
- After AC power has been removed, internal capacitors can remain charged for up to 5 minutes. Wait at least 5 minutes after power down before touching any internal components.
- To reduce the risk of shock, all equipment should be securely grounded to earth ground. Failure to obtain an actual earth ground may result in electrical shock to personnel. Provide equipment grounding in accordance with local code and NEC Article 250.
- When using test equipment (oscilloscopes, etc.) with a power cord that electrically ties probe common to earth ground, an isolation transformer should be used to isolate the instrument common from earth ground.
- Remain clear of all rotating equipment while working on the controls.



## Equipment Safety

- Provide equipment grounding in accordance with local code and NEC Article 250. Failure to obtain a true earth ground may result in electrical shock. Improper grounding is the most common cause of electrical component failure and noise-induced problems.
- Replace components only with main line power off. Damage to equipment or unexpected operation of the elevator may occur if this precaution is not observed.
- Do not substitute or modify parts. MCE will not be responsible for modifications made in the field unless they are approved in writing by MCE.
- Circuit boards believed to be defective must be sent to MCE for repair and testing. Field repair may leave the board with undetected problems.
- Care should be taken when using test leads and jumpers to avoid shorting high voltage or ground to low voltage microprocessor circuits.
- Do not allow dust, carbon, or metallic particles to accumulate on any part of the control.
- Avoid vibration, shock, high humidity, high ambient temperature, and caustic fumes.

## Preparation

When choosing equipment location, consider:

- Logical arrangement, taking into consideration other equipment, electrical power, and seismic zone requirements.
- Do not install equipment in hazardous or vibration prone locations.
- Locate the drive isolation transformer (if used) near the controller to reduce wire runs.
- Ambient temperature should remain within 32° to 104° Fahrenheit (0° to 40° Celsius). Temperatures outside these guidelines may be tolerated, but will shorten equipment life. Adequate ventilation is required. Air conditioning may be necessary.
- The air in the machine room should be free of excessive dust, moisture, or corrosive elements. A NEMA 4 or NEMA 12 enclosure can help meet these requirements if machine room conditions are inadequate. If the machine room has open or unglazed windows or other direct outside openings, place equipment cabinets far enough from them that severe weather does not damage the equipment.
- Very high levels of radio frequency (RF) radiation from nearby sources should be avoided. RFI may interfere with controller components, degrading elevator performance. Using hand-held communication devices close to the controller may also cause interference. Interference from permanently installed radio transmitting antennas is not common.
- Power line fluctuation should not be greater than  $\pm 10\%$ .

### Electrical Noise

Electrical noise readily occurs when two wires run along side one another with one of them a high power conductor and the other a low signal level conductor. The easiest way to avoid noise problems is to keep low-level wiring in separate conduit from high power wiring. If high and low power wiring must be run in the same duct, separate them by a minimum of three to four inches. If one must cross the other, it should be at a ninety degree angle.

Alternately, low level wiring may use shielded cable. The shield drains induced voltage to ground. The shield must be connected to ground at one end only.

### EMI /RFI

To avoid EMI/RFI interference:

- Keep motor leads as short as possible. Run them in a separate conduit.
- Run main line supply leads to the controller or isolation transformer in a separate conduit.
- Run leads from the isolation transformer to the drive cabinet in a separate conduit.
- The controller door will protect against interference only when closed.

### Recommended Tools and Test Equipment

Recommended tools and test equipment:

- Digital multimeter, Fluke series 75, 76, 77 or equivalent
- Hand-held tachometer
- Clamp-on AC ammeter
- Hand-held radios
- Test weights

## MCE Wiring Prints

Become familiar with the wiring prints provided with your control system.

### Drawing Number Format

Each print has a drawing number. The drawing number is comprised of the job number, car number, and page number (see example).

2

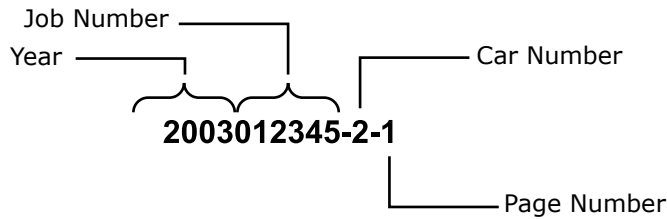

### Nomenclature

The following table lists board reference and part numbers. Your installation may not use all boards listed.

Table 2.1 Component Nomenclature

Reference	Board Name	Description
10	HC-DB-MOD	Front G. A. L. MOD Door Interface Board
11	HC-DB-MOD-R	Rear G. A. L. MOD Door Interface Board
70	HC-CTL	Controller Board
71	HC-RDR	Rear Door Board
74	TC-MPI	Motion Processor Interface to drive
73	HC-UIO	Universal I/O Board
75	HC-CHP	CAN Hub and Power Board
76	HC-MPU	Main Processor Board
	MC-CPI	Control Panel Interface Board
	MC-LSI	Landing System Interface Board
	SC-3HN	Three Input Hall Call Node Board

### Power Nomenclature

MCE job prints and power terminals within the controller are numbered to identify different power buses:

- 1: The number 1 (one) bus is system Common.
- 2: The number 2 (two) bus is AC power.

## Controller Installation

Mount the controller securely to the machine room floor and use provided wiring knock-outs to install raceway or conduit to route wires into the cabinet.



**Caution**

If you drill or cut the cabinet, do not allow metal chips or shavings to fall into electronics. Damage caused by this is not covered by warranty.

**Figure 2.1 Mounting Template for Standard NEMA 1 Cabinet with Feet**

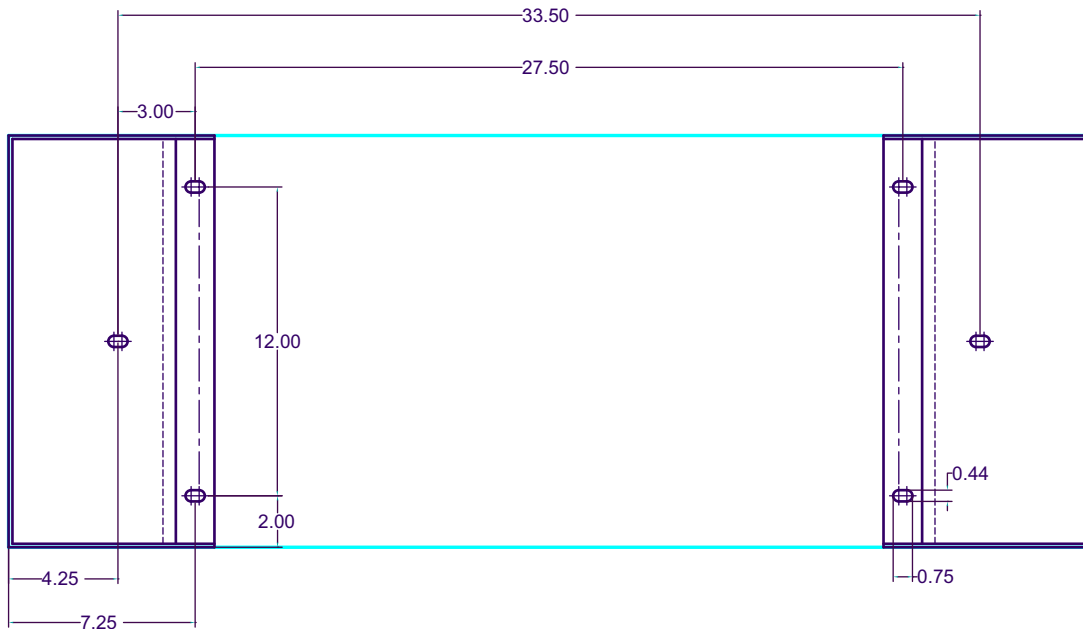

Dimensions for attaching base feet of Standard NEMA 1 enclosure (16" deep x 42" wide) to floor.

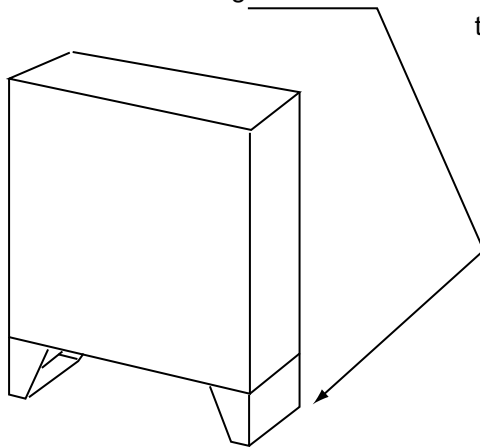

## Controller Wiring Guidelines

Detailed instructions for connecting the Motion 4000 controller and accompanying components are contained in the drawings package for the job. During the job survey, site-specific information collected is used to engineer the drawings package. Contact Motion Control Engineering immediately if you have questions about the drawings or need additional assistance.



### Note

Be aware of the hierarchy of the inspection inputs. (Cartop has highest priority. In-car is next. Machine Room is last.) In order to maintain safe operation of the lift while on access, car top, or in-car inspection, the inspection circuits must be wired as shown in the prints.



### Caution

PC boards can be easily damaged by Electrostatic Discharge (ESD). Use a properly grounded wrist strap when touching PC boards. Do not touch PC Boards unless you are properly grounded.

- Use the wiring ducts in the controller. The terminals are located conveniently near them.
- Connect wires according to hoistway and car wiring diagrams.
- If the car is part of a duplex or group, there are additional steps related to wiring interconnects between individual cars:
  - A separate conduit or wiring trough must be provided for the CAN link between each controller cabinet.
  - Wiring details are shown in the job prints.
  - Ground all cabinets according to applicable guidelines. [Please refer to “Proper Ground” on page 2-7.](#)

## Proper Ground

Provide equipment grounding in accordance with local code and NEC Article 250. A proper ground is essential to trouble free operation. Ground is defined as a direct connection to EARTH GROUND. This type of ground is not always available in the electrical supply panel.

Electrical conduit is not a sufficient ground. Electrical ground should be obtained and certified by the electrical contractor. When seeking an adequate EARTH GROUND:

- Consult with the building engineer or electrical contractor to determine the best source for a low impedance ground.
- Sprinkler system water pipe is not adequate because the sprinkler system is, in most cases, isolated from a free flowing earth water source.



### Danger

If a poor ground connection is used and a true electrical ground is later introduced into the system, the difference in potential can lead to the possibility of severe electrical shock to personnel and damage to test equipment.

- The chosen ground must conform to all applicable codes. Proper grounding is essential for system safety and helps to reduce noise-induced problems.
- Direct, solid grounding must be provided in the machine room to properly ground the controller and the motor.

**Figure 2.2 Ground Wiring to Controller Cabinet**

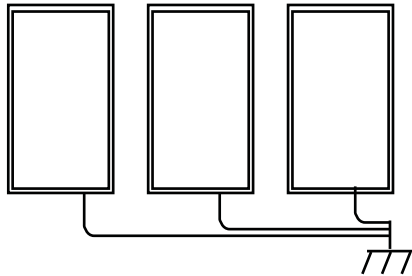

1. An uninterrupted ground wire should be run from each car controller cabinet chassis or back plate to earth ground. The connection at the car controller must be free of paint so connection is made to bare metal. There should be less than 1-ohm to ground with the power off.
2. Ground straps, or short loops of ground wire, should be run from the controller ground connection to the primary duct connections.
3. An uninterrupted ground wire should be run from the hoist motor frame to the controller ground. The ground connection to the hoist motor must be free of paint.
4. An uninterrupted ground wire should be run from a termination point on the cab to the controller ground.
5. An uninterrupted ground wire should be run from the cab enclosure to the ground terminal on the cab to protect passengers from electrical shock.
6. An uninterrupted ground wire should be run from each car operating panel to the ground terminal on the cab to protect passengers from electrical shock.
7. An uninterrupted ground wire should be run from the dispatch cabinet chassis or back plate to earth ground. The connection must be to the bare metal of the enclosure.

## Check for Shorts to Ground

Check for shorts to ground before powering up the system. **Power must be OFF at the main disconnect.** If any shorts to ground are discovered, they must be corrected before proceeding. A short to ground is defined as having a resistance of less than 20 ohms between ground and the terminal being tested.



### Danger

Be certain that power is OFF at the main disconnect before proceeding.

1. Disengage all 2 Bus fuses.
2. Measure the resistance between the 1 Bus (common) and all field connection terminals.
3. Check for shorts to ground on motor power terminals L1, L2, and L3.
4. Check for shorts to ground on brake terminals B1 and B2, EB1, and EB2 (as applicable).
5. If no shorts to ground are discovered, re-engage the fuses.

## AC Power Connections

- All conductors entering or leaving the controller must be through conduit.
- High voltage, high current conductors must be separated from control wires.
- Velocity encoder or tachometer wires must be routed in a separate conduit from high voltage, high current wires.
- Incoming power to the controller and outgoing power to the motor must be through separate, grounded conduits.

**Brake Module** If your job uses a brake control module, your job drawings may show auxiliary power connections specific to the brake from an isolation transformer. Follow the drawings carefully.

1. Check the AC input specifications on your job prints. Verify that the AC supply is as specified.



### Note

Proper motor branch circuit protection in the form of a fused disconnect switch or circuit breaker must be provided for each elevator according to applicable electrical code. Refer to the drive manufacturer manual for proper drive circuit fuse sizing. Each disconnect or breaker must be clearly labeled with the elevator number. The electrical contractor must determine the wire size for the main AC power supply and for the wiring from the disconnect or breaker to the controller or isolation transformer.

2. Connect AC supply wiring as shown in the job prints.

## Power Check

After connecting power, it is a good practice to temporarily power up the control to check functionality before connecting any field wiring.

1. Verify that the Inspection switch on the Control Board is in the Inspection position.
2. Visually check for loose connections or components.
3. Verify that fuses FB1 and FB2 are disengaged to prevent the brake from lifting.
4. Have a helper power up the controller and remain by the disconnect ready to shut down immediately if needed.
5. Check that the Power On LED on the CHP (CAN Hub) board is on.
  - Verify all transformer and power supply voltage levels are correct per the job prints.
  - Verify all fuses are intact.
  - Check phase-to-phase input voltage. If necessary, shut off main power and swap two of the incoming feeds at the controller main terminal.
6. After verification, shut down the controller and engage fuses FB1 and FB2 before continuing with field connections.



## Motor, Brake, and Encoder Connection



### Danger

Verify that power to the controller has been shut off at the main disconnect before proceeding with connections.

## Motor Connection



### Caution

If you are reusing an existing hoist motor, you must check it for insulation breakdown before proceeding. Applying power from a modern drive to a motor with insulation problems can damage the motor and/or the drive.

### Insulation Breakdown Test

1. Disconnect all motor and brake wiring.
2. Perform an insulation test between motor and brake connection points and the body of the motor. Use a Megohm meter to subject the insulation to the same high voltage that would be present during elevator operation.
3. A minimum insulation resistance of 100k Ohms is required.
4. Correct any insulation problems before proceeding with installation. Insulation problems may indicate a serious problem in the equipment.

### Motor Wiring

Incoming power to the controller and outgoing power wires to the motor must be through separate grounded conduits.

1. Refer to the power section drawing in your job prints.
2. Make connections as shown. Be sure to follow any notes regarding wire sizes.
3. Pay particular attention to motor grounding instructions in the job prints and in the motor manufacturer instructions.

### MRL or Extended Motor Cables

If cables from the drive to the motor are over forty feet / 12 meters in length, high voltage peaks or high rates of voltage rise can occur on the motor windings, potentially damaging the motor. In these installations, a special output filter may be recommended by the drive manufacturer. Both cable length limitations and filter configuration are dependent on the drive. Refer to the drive manufacturer manual for specific information and treatment.

## Brake Connection

Motion 4000 controllers may be ordered with or without a brake control module. The module allows more precise control of brake lift and drop rates.

### Standard Brake

1. Refer to the brake circuit drawing in your job prints to verify the configuration of the braking circuit. (Brake control and brake adjustment resistors vary from job to job.)
  - Familiarize yourself with the brake pick, hold, and drop time adjustments.
2. Measure the resistance through the brake coil on the lift machine.
3. Initially, adjust resistance across the Brake Drop Time resistor(s) to three times the measured brake coil resistance.



#### Note

This resistance determines brake drop time. Too little resistance causes the brake to remain picked for a longer time, perhaps allowing rollback before stopping the car. Three times brake coil resistance is usually a good starting point.

4. Connect the wires from the controller to the brake as shown in the job prints. Remember that brake wires must not be routed in the same conduit with motor power or velocity encoder wires.

### Brake Module

If the job uses one machine brake as the service brake and the second machine brake as an emergency brake, a brake module will be provided for each.

- Connect the wires from the controller to the brake as shown in the job prints. Remember that brake wires must not be routed in the same conduit with motor power or velocity encoder wires.

Brake modules are calibrated at the factory according to the survey information for the job. These settings must all be verified and some adjustment will probably have to be made during installation. [Please refer to “Calibration \(CAN Only\)” on page 5-82.](#) Both calibration and adjustment are described in the referenced area of the manual.

## Brake Mechanics

Check basic brake characteristics at this time:

- Ensure that the brake mechanism is clean and in good condition.
- Check that the brake lining makes good contact with the machine braking surface (at least 95% of the pad must be in contact with the braking surface).
- Check that the adjustment of the brake solenoid is not preventing the brake from fully applying when it is not energized.
- Check to see that the spring adjustments are equal and are torqued to the manufacturer recommended brake torque settings.

## Velocity Encoder Installation and Wiring

The velocity encoder reports hoist motor speed to the controller. The encoder must be mounted and wired according to the drawings. When installed, the encoder must be electrically isolated from the motor or any other ground. (Resistance between the encoder casing and the motor or other ground should be “infinite.”)

Do not place the encoder or its wiring close to a magnetic field (the motor or brake coils). Magnetic fields can induce AC into the encoder signal. This can cause the drive to miscount, producing erratic control at lower speeds.

### Note

The encoder wiring must use a separate grounded conduit. Inside the controller cabinet, if control wires must cross power wires, they must cross at right angles to reduce the possibility of interference. We recommend you use oversize conduit (typically 2- inch) so that connectors may be fed through without having to disassemble the cable.

## Encoder Wiring



### Caution

**Check job prints and installed encoder type to be certain they match. ONLY WHEN the drive is switched off and the voltage supply is disconnected may the feedback (encoder) connections be removed or connected.**

A shielded cable with an appropriate connector at the encoder end is connected to the drive if the type of encoder is known before the job is shipped. If the encoder type is unknown, the cable ends expose trimmed and tinned individual conductors and the installer must attach the encoder connector and make the proper connections at the drive end. The encoder cable must be routed into the controller cabinet in a separate conduit from brake or power conductors.

1. Route the cable through a separate conduit to the controller cabinet.
2. If it was not done at the factory, connect the controller end of the cable as shown on the drive interface sheet of the job prints and according to the encoder manufacturer instructions.
3. Connect the encoder end of the cable to the encoder. (If you are providing the connector, follow the encoder manufacturer instructions.)



### Caution

Do not coil excess Encoder cable near high voltage components — noise may be induced. If the cable must be shortened, trim it at the drive end. Do not cut and re-splice in the middle of the cable or shorten at the Encoder end.

## Emergency Brake Installation

Depending upon job configuration, a rope gripper, a sheave brake, or one of the two machine brakes may be used for emergency braking (unintended motion prevention).

1. Refer to your job prints.
2. Connect the rope gripper or sheave brake as shown.



### Note

If you do not yet have the rope gripper or sheave brake on site, refer to [Construction Mode Jumper Requirements on page 2-28](#).

## Resetting the Rope Gripper

During setup, the rope gripper or sheave brake may well be triggered. To reset the unit:

1. Place the car on Machine Room Inspection.
2. Press and hold the Emergency Brake reset button, EB RST, on the TC-MPI board for eight seconds, then release.
3. Return to normal operation. Check the fault display and correct faults as necessary.

## Initial Power Up



### Danger

Always have a helper standing by the AC disconnect to power up the controller and to immediately shut down if necessary.

1. Verify brake and motor wiring is correct.
2. On the HC-CTL board, verify that the Machine Room Inspection switch is in the INSP position.
3. Physically verify that all car and hoistway doors are closed and locked and that no one is in a dangerous position should the car move unexpectedly.
4. Power up the control. Be prepared to immediately shut it down if the car slides or attempts to move.
5. Check that the drive is displaying no fault conditions.



### Caution

Turning the control on and off repeatedly (more than once every two minutes) can damage the inverter drive.

## Often Used Procedures

Following are some procedures and techniques that are often used while setting up drive and controller parameters:

### How to check Car Speed:

1. Place Function Switch F3 on the HC-MPU board in the ON (up) position.
2. Press the N push button until CONTROLLER SYSTEM MENU is displayed.
3. Press the S push button to select the menu.
4. Press the N push button until POSTN and SPEED are displayed.
5. Run the car. Speed is displayed in feet per minute.

### How to place the car on Inspection Mode Fault Bypass:

1. On the HC-MPU board, place Function Switch F3 in the ON (up) position.
2. On the HC-CTL board, use a jumper to short the pins of JP1 Fault Bypass.
3. Press the N push button until CONTROLLER SYSTEM MENU is displayed.
4. Press the S push button to select the menu.
5. Press the N push button until INSPECTION MODE FAULT BYPASS is scrolled on the display.
6. Press the S push button to change the setting to BYPASS ON.

Inspection mode fault bypass remains activated, even across power cycles, until switched off.

#### Note

In the F3 menu, Automatic Mode Fault bypass is just before Inspection Mode Fault bypass. When you want Inspection Mode bypass, be careful you do not mistakenly set Automatic mode.

### How to place the car on Automatic Mode Fault Bypass:

1. On the HC-MPU board, place Function Switch F3 in the ON (up) position.
2. On the HC-CTL board, use a jumper to short the pins of JP1 Fault Bypass.
3. Press the N push button until CONTROLLER SYSTEM MENU is displayed.
4. Press the S push button to select the menu.
5. Press the N push button until AUTOMATIC MODE FAULT BYPASS is scrolled on the display.
6. Press the S push button to change the setting to BYPASS ON.

Automatic mode fault bypass times out after two hours.

**How to change TORQMAX F5 Drive parameter settings:**

1. Use ENTER and START/STOP buttons to select the parameter group and parameter number.
2. Press FUNC. to display the parameter value.
3. Press START/STOP to increase/decrease the parameter value.
4. Press ENTER to save the new parameter value.

**How to change Magnetek Drive parameter settings:**

1. Use left/right arrow keys to navigate through menus.
2. Use up/down keys to navigate through submenus.
3. Use Enter to select a submenu.
4. Use up/down keys to navigate through items in a submenu. Use Enter to select an item.
5. To change a value, use left/right keys to select the character to be modified and up/down keys to change the value.
6. Use ESCAPE at any time to move to the next higher level.

**How to access/set the F7 parameters:**

**Important** Once set at the factory, F7 parameters are protected by positioning a jumper on the HC-CTL board. Before you can access F7 parameters, you must be in Inspection mode and set the jumper appropriately:



1. On the HC-MPU board, place Function Switch F7 in the ON (up) position.
2. Press the N push button to begin. DOWNLOADING PARAMETERS FROM MPU is scrolled followed by parameter zero, ADJUST FLOOR 0IF POSITION....
3. The parameters are numbered 0 through xxx. Press the N push button to advance to the next parameter. Press and hold the N push button to advance at high speed. Press the N plus minus (-) push buttons to move to the previous parameter.
4. Use the plus (+) and minus (-) push buttons to change the parameter setting.
5. When you have finished setting parameters, press the S push button to exit the menu. ADJUST COMPLETE, PRESS (S) TO STORE is scrolled on the display. Press the S push button to store your changes. STORING VALUES... is displayed followed by VALUES STORED.

**How to Reset Excessive Faults**

Many of the faults generated while performing acceptance tests are self-resetting once the fault condition is corrected. However, this controller has excessive faults logic which will generate an EXCESSIVE FAULTS SHUTDOWN if more than the established limit of faults occur within the circumscribed period of time. To reset this fault:

- Press the Fault Reset button on the HC-CTL board.

## Auto Tuning and Encoder Data Loading

Drives used in Motion 4000 applications provide auto tuning procedures which allow the drive to directly learn motor characteristics. Tuning both improves performance and automatically calculates some motor values you would otherwise have to enter manually.

For permanent magnet, AC gearless machines, if a Hiperface, EnDat, or Sin/Cos encoder was pre-installed by the motor manufacturer, motor data information may have been stored in the encoder. The Torqmax drive allows you to read and store this data, saving more setup time, avoiding auto-tuning, and automatically learning the encoder position with relation to a pole of the motor.

2



### Danger

Motor circuits may have high voltage present any time AC power is applied to the controller, even if the motor is not rotating. Wait 10 minutes after removing AC power to allow capacitors to discharge before you open the drive cover. Use extreme caution. Do not touch any circuit board, power device, or connection without ensuring that high voltage is not present.

## Torqmax/Keb F5 Drive Introduction

The Torqmax F5 drive is a Keb F5 with custom software specific to Motion Control Engineering. Take the time to study the drive manual. It has very important startup and other information that are beyond the scope of this manual.

### Digital Operator

The keypad and LED display are mounted on the digital operator. The operator must be plugged into the drive or the drive will not function. If the operator is removed while the drive is operating, the drive will shut down immediately. If you must remove the operator, do so while the elevator is standing still.

Figure 2.3 Torqmax F5 Drive



Figure 2.4 Torqmax Display

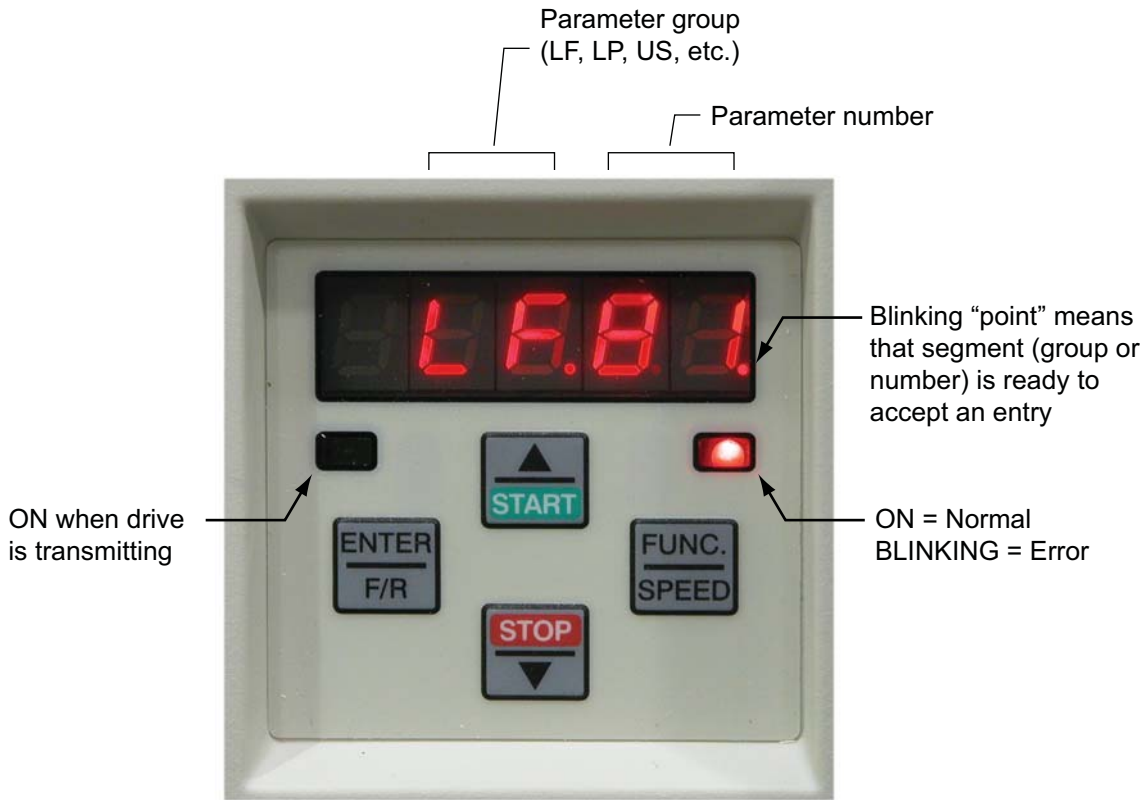

### Keypad Operation

Please refer to "KEB Keypad Overview" on page 2-19.

### Clear Error

If an error is displayed (E. UP, etc.), the drive will shut down. To clear the error:

- Press ENTER

The E.ENCC error is an exception and must be cleared using parameter LF.26.



Figure 2.5 KEB Keypad Overview

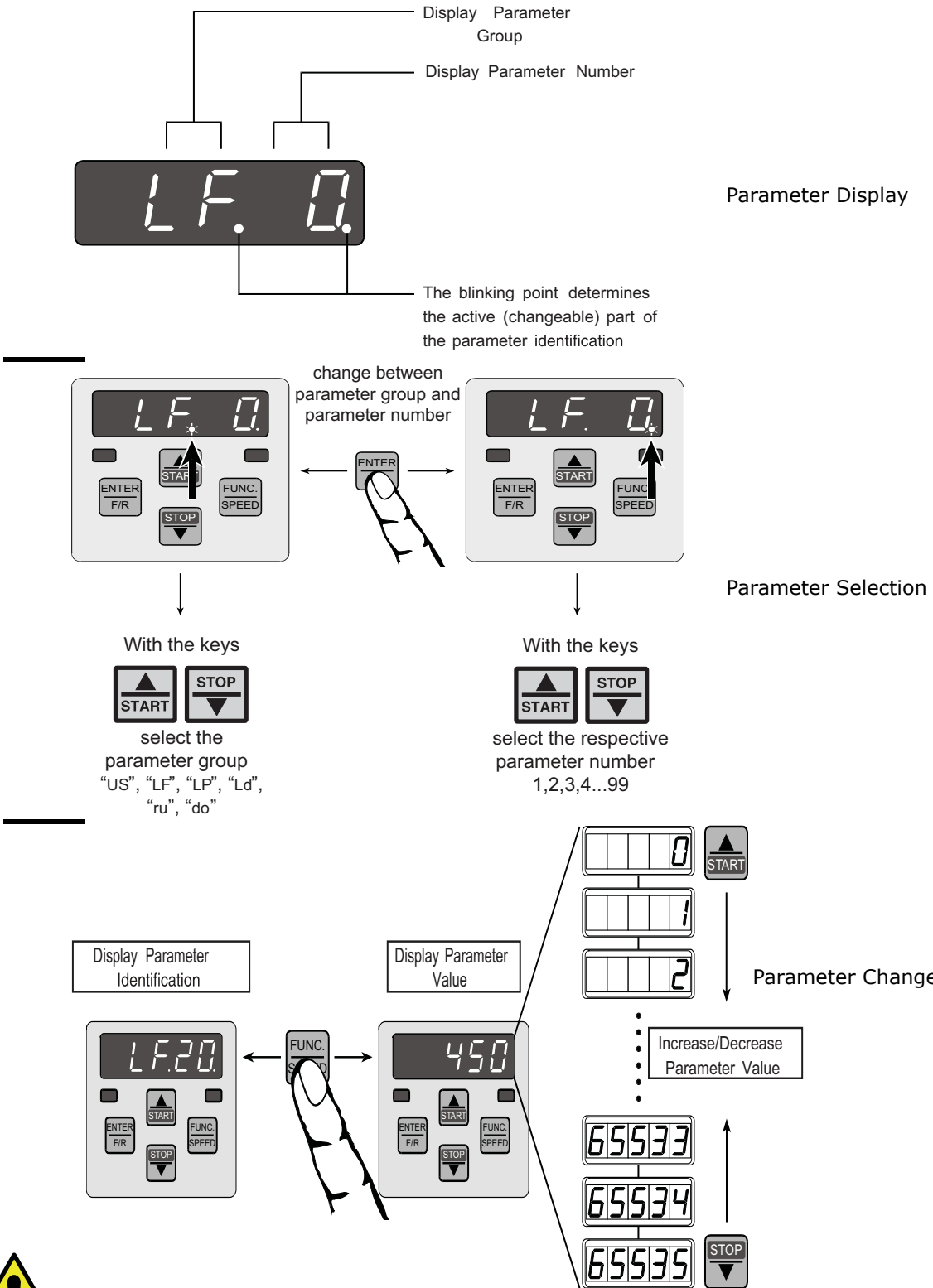

Changes are accepted and saved only after ENTER is pressed. Some parameters cannot be changed while the elevator is operating.

### TorqMax/KEB Drive Operation Overview

The LF.3 parameter determines the mode the drive is in. The drive default mode is “run.”  
 Generally:

- Set LF.3 to Stop to adjust parameter values
- Press Enter to save the adjusted value
- Set LF.3 to run and press Enter to run the elevator using the controller Inspection controls or for normal operation

### Drive Motor/Encoder Setup Overview

Figure 2.6 F5 Motor/Encoder Setup Overview

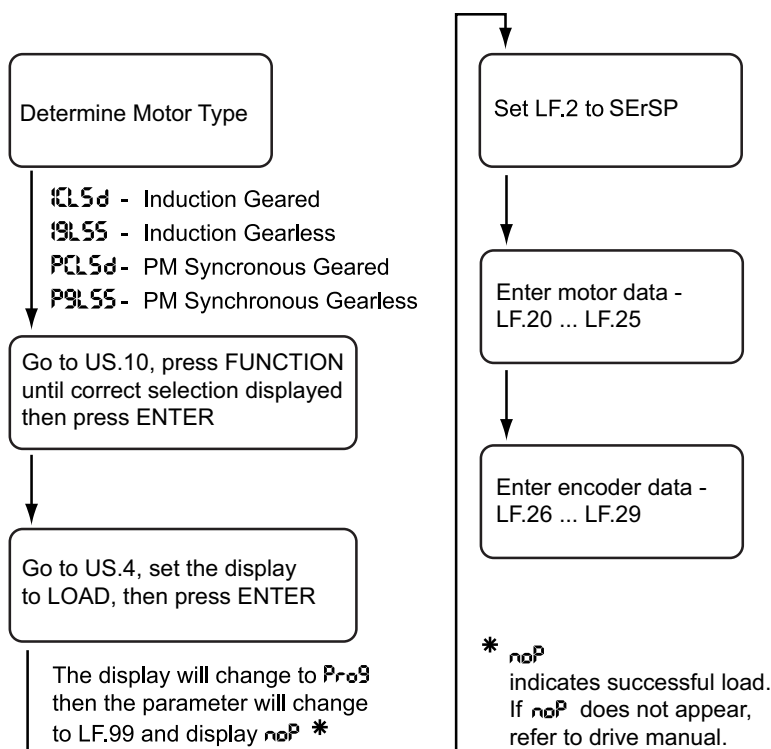

**Check Correct Motor/Control** The drive is set up at the factory to match your job configuration. However, before anything else, check that read-only parameter LF.4 displays the correct motor type:

- Induction geared/Closed Loop: ICL5d
- Induction gearless/Closed Loop: IGL55
- PM Synchronous geared/Closed Loop: PCL5d
- PM Synchronous gearless/Closed Loop: PGL55

**Check Control Mode** Drive parameter LF.02 determines control mode. Check that control mode is set to SerSP (Serial Speed Control).

**Learn or Enter Motor or Encoder Data** In order to enter motor nameplate data into the drive, learn motor information, or learn encoder information, you must activate parameter LF.3 appropriately:

- conF (configuration): Operation troubleshooting (90 second time-out)
- S Lrn: Auto tuning drive to motor
- run: Sets drive to run mode
- I Lrn (inertia learn): Learns system inertial / activates FFTC.
- P Lrn (pole learn): Learns motor pole positions (see drive manual).
- StoP: Motor cannot run. Parameter changes allowed with serial control.



**Note**

When StoP is active, the drive will not respond to the direction inputs and therefore, the motor will not run.

### Auto-tuning AC Induction Motors to the F5 Drive

Auto-tuning provides better drive to motor matching and performance than manually entering parameters. Before beginning, make sure that the following parameters have been loaded into the drive:

- Rated Motor Power (horsepower) (LF.10)
  - Rated Motor Speed (rpm) (LF.11)
  - Rated Motor Current (A) (LF.12)
  - Rated Motor Frequency (Hz) (LF.13)
  - Rated Motor Voltage (LF.14)
  - Rated Power Factor (LF.15) (not viewable for PMAC machines)
1. Verify the controller is on Inspection operation.
  2. Remove one brake wire from the controller or reduce brake pick voltage level to prevent the brake from picking.
  3. Set LF.3 to S Lrn. The display will change to StArt.
  4. Hold the controller Enable button down and select the Up direction. The motor contactor should engage but the brake should not pick. Motor current will begin to flow and the drive display will change to LS103.

The drive will measure motor parameters as well as parameters in the drive motor stage. The drive display will change as different values are measured.

5. Continue holding the Enable and Up direction switch until the drive displays “done” (five minutes is typical).
6. Release the Enable and Up direction switches. The drive will display CALC and complete updating its parameters.
7. Return the drive to Run mode (LF.3). Reconnect the brake wire.

If the auto-tune was not successful, the drive will report:

- FAIL: Auto-tuning was interrupted. Repeat the procedure.
- FAILd: There is a configuration error, probably an incorrectly set parameter, that is preventing the drive from beginning measurements.
  - Check connections and parameters.
  - Consult MCE.

### Manual Induction Motor Parameter Entry

The preceding instruction for auto-tuning the drive to the motor provides better performance and should be used instead of manual entry. If auto-tuning is not possible, use manual entry.

Figure 2.7 Entering Induction Motor Data

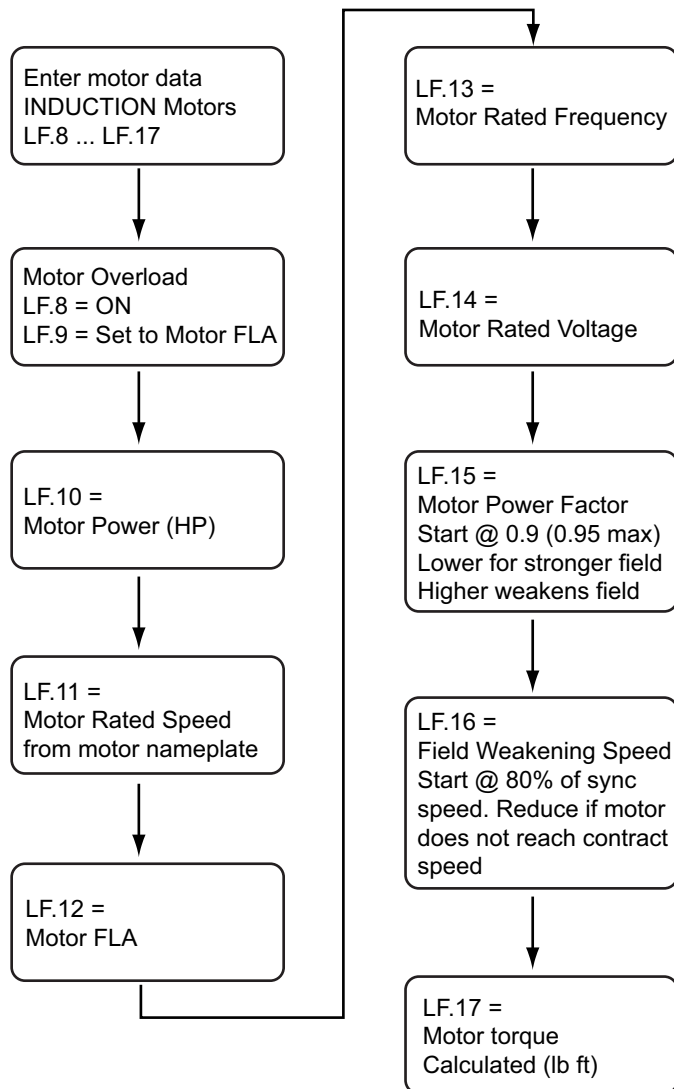

### The Drive Manual

The information included above is very basic. If you are not familiar with the Torqmax F5 drive, you must take a few minutes to look through the drive manual to learn how to proceed, what to expect, and what adjustments are available through the drive.

### Loading Data from PM AC Encoder to the F5 Drive

EnDat, Sin/Cos, and Hiperface encoders are capable of storing critical operating information, including motor pole position/encoder absolute position data. If the encoder was installed on the machine/motor by the machine supplier, they may have pre-loaded this data into the encoder. If so, you can download it to the drive.



#### Note

Typically, a drive can be used with many different encoders. This is accomplished by using an interface card in the drive that is specific to the encoder. It is very important that the card installed in your drive is correct for the encoder you are using. Check your drive manual for information about displaying the installed card type. (For Torqmax/Keb F5 drives, parameter 0.LF.26 displays the encoder card type.)

1. Check 0.LF.26 to verify that the encoder card matches the encoder you are using.
2. Check drive parameter 2.LF.26 to verify serial communication (“conn” displayed).
3. Go to parameter 3.LF.26 and press Function. The display will change to IdLE.
4. Press the drive UP arrow. The display will change to rdEnc.
5. Press Enter. The display will change to “no”.
6. Press the UP arrow. The display will change to YES.
7. Press Enter. The display will change to rEAd. The drive will read the encoder data and update motor and drive parameters.

This process loads motor parameters LF.10 through LF.19, LF.27, LF.34, LF.35, and LF.77. Refer to the drive manual for more information if necessary.

### Learning Encoder Data From PM Machines

If the motor data was not pre-loaded into the encoder by the supplier, you will need to learn the information by running the motor. Refer to the procedure for aligning an absolute encoder for use with a permanent magnet motor in the drive manufacturer manual.

As stated earlier, the drive manual provides a step-by-step start up procedure for preparing the drive to run with your machine. Read and follow the drive manufacturer instructions.

### Setting the Drive to Run Mode

Parameter LF.3 allows the drive to be configured, to learn, or to be placed in run mode. To set the drive to run mode:

1. Set LF.3 to **run**.
2. Press **ENTER**.

### Magnetek AC Drive Introduction

Take the time to study the drive manual. It has very important startup and other information that are beyond the scope of this manual.

#### Digital Operator

The keypad and display are mounted on the digital operator.

Figure 2.8 Magnetek AC Drive



#### Keypad Operation

Please refer to “Magnetek Keypad Overview” on page 2-25.

#### Clear Fault

Most faults clear automatically. If a persistent (serious) fault is displayed, the drive will shut down. To clear the fault after correcting the cause:

- Access the drive Faults F0 menu, submenu Active Faults, F1.
- Go to Reset Active Faults. Press Enter.

Figure 2.9 Magnetek Keypad Overview

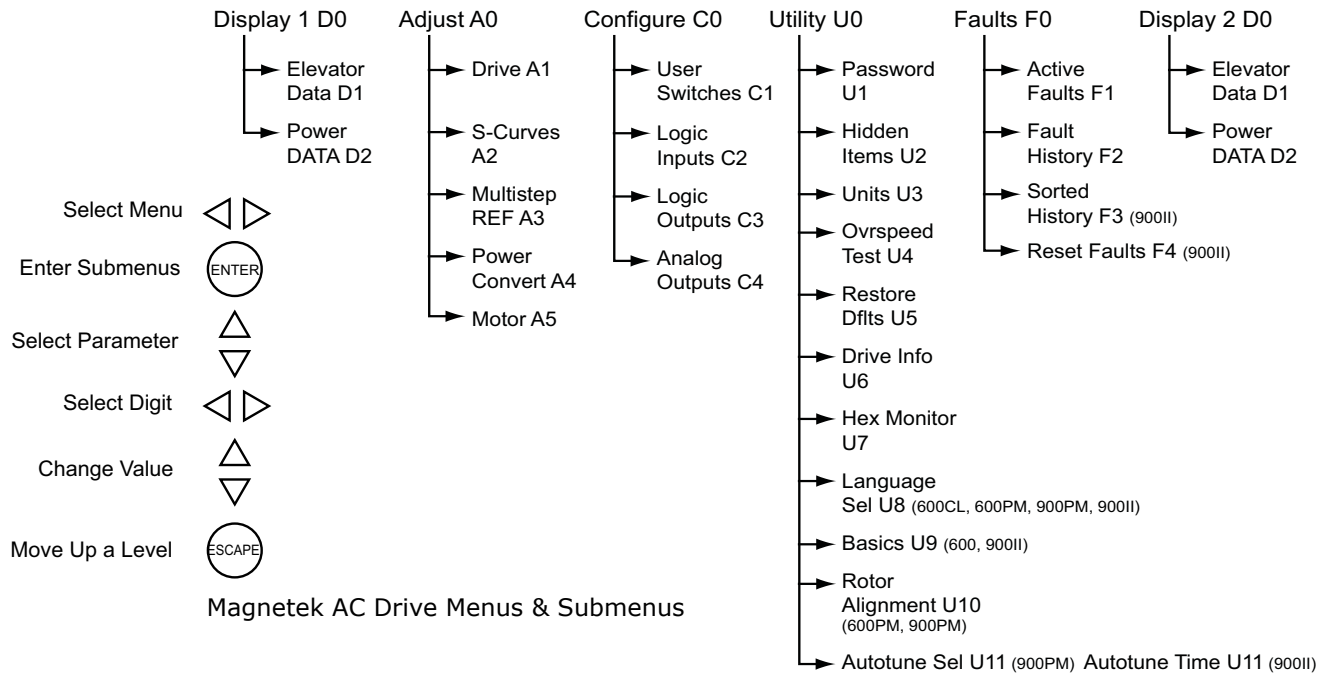

Changes are saved only after ENTER is pressed.  
Some parameters cannot be changed while the elevator is operating.

### Magnetek Drive Operation Overview

Menus, sub menus, and parameters may be accessed while the drive is running. Some parameters may not be changed while the drive is running. For these parameters, the word “LOCK-OUT” appears.

**Operator (HPV600/600PM/900/900PM)** LEDs indicate the status of the drive:

- Run/Fault: The drive is in run mode. Operational status or a Fault code may be displayed.
- Sub Menu: A sub menu has been accessed.
- Data Ent: A parameter value has been accessed.

**Operator (HPV 900II)** LEDs indicate the status of the drive:

- Ready: Ready but not actually providing current to the motor.
- Run: Providing current to the motor.
- User: Selected via Logic Outputs C3 submenu.
- Fault: Drive has declared a fault.
- Torque Limit: The drive has reached its torque limit. See drive manual.
- Sub Menu: A sub menu has been accessed.
- Data Entry: A parameter value has been accessed.

**Cover (HPV 900/900PM) LEDs indicate the status of the drive:**

- **Ready:** Ready but not actually providing current to the motor.
- **Run:** Providing current to the motor.
- **Program Invalid:** No valid software on the drive control board.
- **Fault:** Drive has declared a fault.
- **Torque Limit:** The drive has reached its torque limit. See drive manual.

**Drive Motor/Encoder Setup Overview**

**Figure 2.10 Magnetek Motor/Encoder Setup Overview**

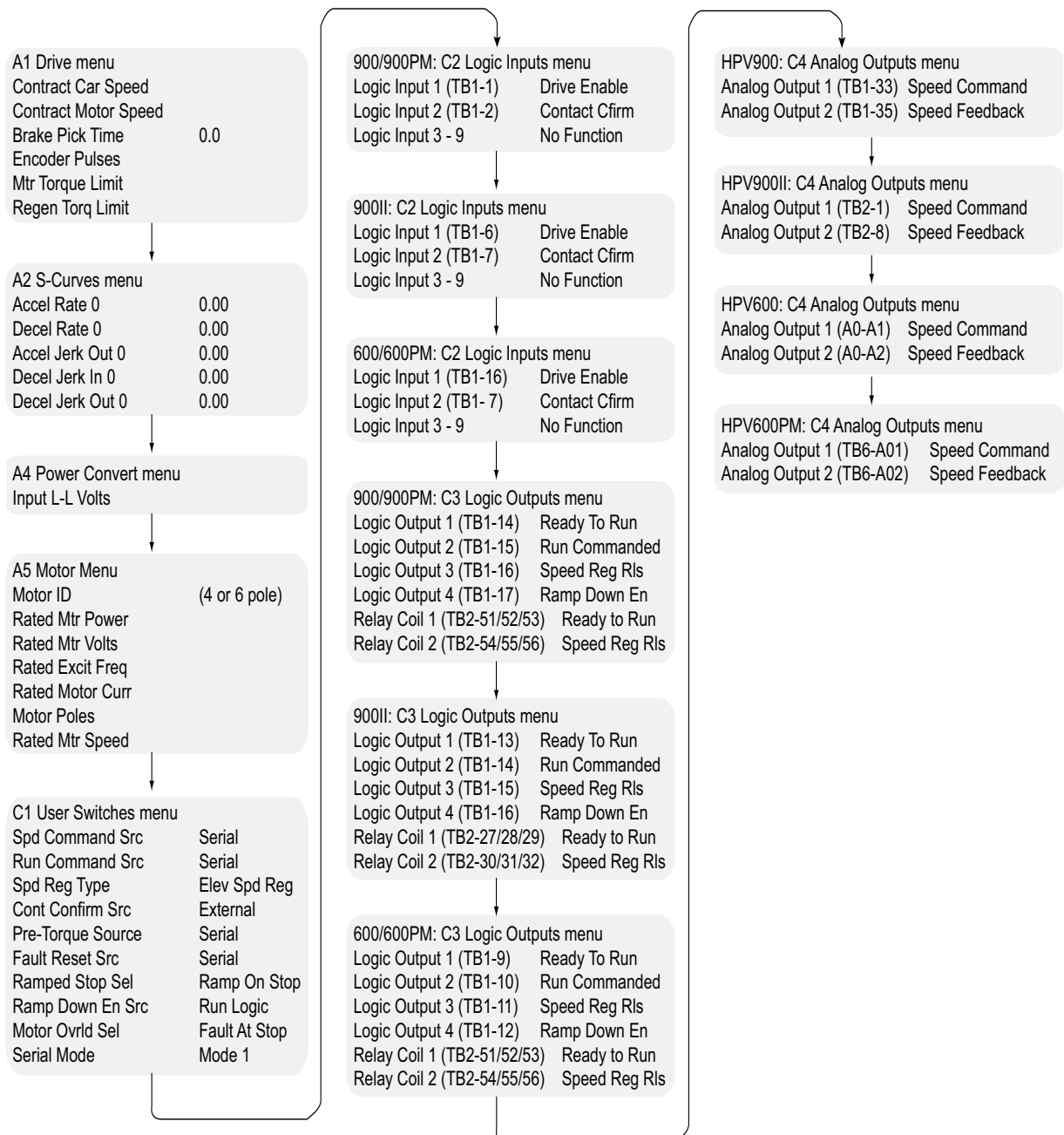



### Auto-tuning AC Motors to the Magnetek Drive

Auto-tuning provides better drive to motor matching and performance and must be performed at some point during installation or adjustment. Because the car must be run through the extent of the hoistway, this procedure should be accomplished after hoistway installations are sufficiently complete. Please refer to Adaptive Tuning in the Magnetek manual and follow those instructions.

**Tuning Motor No-Load Current (HPV 600/900/900II Only)** Please see Tuning No-Load Motor Current in the appendix of the Magnetek HPV AC Drive Technical Manual for specific steps.

**Tuning Motor Flux Saturation Curve (HPV 600/900/900II Only)** Please see Tuning Motor Flux Saturation Curve in the appendix of the Magnetek HPV AC Drive Technical Manual for specific steps.

**Tuning Motor Rated RPM (HPV 600/900/900II Only)** Please see Tuning Rated Motor RPM in the appendix of the Magnetek HPV AC Drive Technical Manual for specific steps.

**Determining System Inertia** Please see Using the Software to Estimate the System Inertia in the appendix of the Magnetek HPV AC Drive Technical Manual for specific steps.

### The Drive Manual

The information included above is very basic. If you are not familiar with the Magnetek drive, you must take a few minutes to look through the drive manual to learn how to proceed, what to expect, and what adjustments are available through the drive.

## Set Up for Construction Operation

If required, it is possible to run the car during construction to help complete work in the hoistway. In this mode, the car runs at inspection speed. If they are in place, cartop controls may be used or the car may be run from the controller or a temporary run box. (Refer to [Temporary Run Box on page 2-50.](#))

### Minimal Requirements

Minimal equipment requirements are:

- The governor must be wired into the Safety string (SAFH).
- Car and counterweight must be roughly balanced.



Typically, the counterweight is sized to equal the weight of the car with 40%, 45%, or 50% of its rated full load weight inside. At inspection speed, in the middle of the hoistway, with the car properly loaded, drive current readings (F5, LF.93 or Magnetek D0/D2 MOTOR CURRENT) should be equal in both up and down directions if counterweight/car balance is approximately correct. A balancing procedure is provided in this section but, before you attempt to run the car on Inspection, you must check that counterweighting has been addressed. Please refer to [Car and Counterweight Balance on page 3-6.](#)

- If used, the temporary run box must be connected through the safety string. [Please refer to “Temporary Run Box Hookup.” on page 2-50.](#)
- Motor, brake, and drive connected and set up.
- Velocity encoder or tach connected and functioning.
- Jumpers must be temporarily used to bypass absent equipment.
- The controller must be set to bypass faults on Inspection operation

### Jumper Requirements

Temporary jumpers, as necessary, may be placed across the following connections if needed to run the car on construction operation. If you are using a temporary run box, [Please refer to “Temporary Run Box” on page 2-50.](#)

**Table 2.2 Construction Mode Jumper Requirements**

From	To
Panel Mount Terminal 15	SAFH HC-CTL board (Safety String, Hoistway)
SAFH HC-CTL board (Safety String, Hoistway)	SAFC HC-CTL board (Safety String, Car)
SAFC HC-CTL board (Safety String, Car)	ESC HC-CTL board (In-car Emergency Switch)
2S (120VAC)	GS HC-CTL board (Gate Switch, car door locks)
2S (120VAC)	GSR HC-RDR board (rear gate switch, car door locks)
2S (120VAC)	DLAT HC-CTL board (Door Lock Access Top, hall doors)
2S (120VAC)	DLAB HC-CTL board (Door Lock Access Bottom, hall doors)
2S (120VAC)	DLATR/DLABR HC-RDR board (if rear door present)
G0S1 (Governor overspeed switch)	GOS2 (Governor overspeed switch)
RG7 (rope gripper)	RG5 (rope gripper)

## Bypassing Faults on Inspection

Because the hoistway has not been set up yet, the car does not have direction limit inputs and will be prevented from moving properly in the hoistway unless the faults generated by this lack are bypassed. To bypass faults on Inspection mode:

1. On the MPU board, place switch F3 in the UP position (all others down).
2. On the HC-CTL board, use a jumper to short the pins of JP1 Fault Bypass.
3. Press N until the display shows Controller System Menu.
4. Press S to enter the menu.
5. Press N until the LCD displays Inspection Mode Fault Bypass OFF.
6. Press S to change bypass state to ON.
7. Set F3 back to the DOWN position.

2

This setting bypasses controller response to faults during Inspection operation.

### IMPORTANT

**Because the directional limits are not in place, if the car is not set to Bypass Faults on Inspection, it will not move down the hoistway.**

#### Note

Note that there is an Automatic Mode fault bypass accessible through the Controller System Menu as well. Be careful you are not setting it instead of Inspection Mode bypass.

Inspection mode fault bypass remains active, even across power cycles, until set to OFF. Automatic Mode fault bypass times out after two hours.

On both Inspection and Automatic Mode bypass, only overspeed faults are recognized.

## Resolving Faults

If the car does not respond to a run command, check the HC-MPU board and drive displays for error/fault codes. [Please refer to “Status and Error Messages” on page 5-2.](#)

Error codes are displayed individually in the order of detection. It is possible that, after you correct a current error condition, another will be displayed. All errors must be resolved before the car will operate properly.

Support for troubleshooting position and speed related faults is provided in Sections 4 and 5 of this manual. [Please refer to “MPI Diagnostic Menu” on page 4-64](#) and to Section 5.

## Speed and Acceleration Control

Motion 4000 generates the performance curve that controls the drive and transfers that information to the drive through a serial connection. Speed, acceleration, deceleration, and jerk parameters are set up through the F7 menu on the controller (HC-MPU board/controller on Inspection/F7 function switch UP/all other function switches DOWN).

Even though speed and acceleration/deceleration/jerk parameters are determined by Motion 4000 settings, certain drive settings can still have a limiting effect and, if set incorrectly, can prevent the elevator from reaching commanded speed.

Drive gear ratio, rated RPM, contract speed, roping ratio, and sheave diameter settings dictate the fastest speed at which the drive will run the motor and must be accurately set on the drive. In the illustration below, the dashed line labeled DRIVE CLIPPING illustrates what can happen to the S-curve if drive settings limit commanded speed. Rather than rolling into commanded speed, the car will drop into a steady speed state abruptly, will run at a less than commanded speed, and will drop into deceleration abruptly. So, improper drive settings can cause failure to achieve commanded speed and bumpy transitions at speed/acceleration transition points.

**Figure 2.11 Example of Drive Clipping**

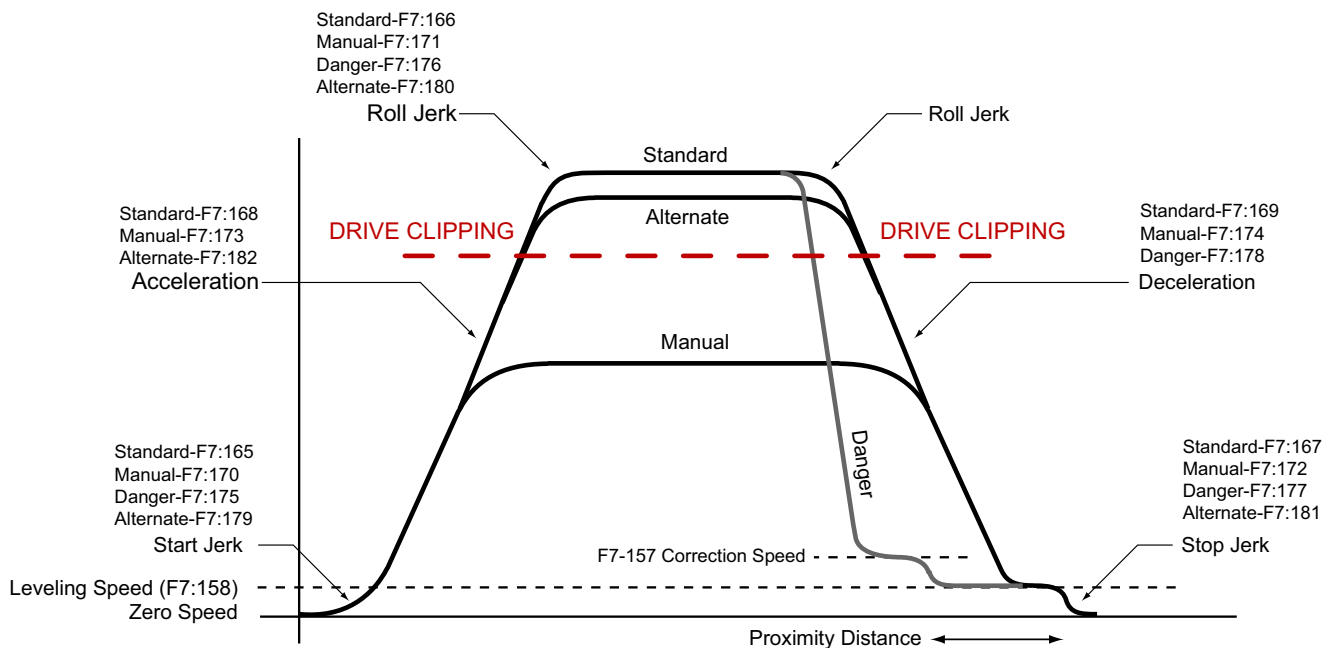

## Required Drive Parameter Settings

In order to operate safely in construction, particular drive parameters must be verified and set. These parameters are set at the factory according to your job requirements but **MUST BE CHECKED** for correctness **BEFORE PROCEEDING**.



**Caution**

Before powering the controller to make these settings, verify that the Inspection/Normal switch is in the Inspection position.

### Torqmax F5 AC Drive Parameters

Set drive parameters using the drive keypad. If drive parameters are not correctly set, attempting to move the elevator can be **VERY DANGEROUS**. MCE sets these parameters before shipment, but you must check them at the site.



**Danger**

Drive parameters must be correctly set. If not, elevator control can be erratic and potentially **DANGEROUS**. Never change drive parameters while the elevator is running.

1. Read the drive manufacturer manual shipped with this controller. It provides essential information about setting up the drive that cannot be included in the MCE manual. Follow the Initial Start-up procedure described in the drive manufacturer manual.
2. Read and follow the parameter settings in the table shipped with the controller from MCE.

**Table 2.3 Critical F5 Drive Parameters**

Parameter	Parameter
LF.02 Operating mode: SErSP	LF.21 Traction sheave diameter
LF.04 Per Motor	LF.22 Gear reduction ratio
LF.10 Rated motor power (HP)	LF.23 Roping ratio
LF.11 Rated motor speed	LF.24 Load weight
LF.12 Rated motor current	LF.27 Encoder pulses
LF.13 Rated motor frequency	LF.30 Closed Loop: 2
LF.14 Rated motor voltage	d.LF.33 Ki speed offset decel
LF.17 Rated motor torque	LF.42 High speed
LF.20 Contract speed	US.35 Reference splitting: 40

The following drive parameter table is included for your convenience and in the event the table shipped with the controller is not available. Note that the table here reflects generic settings, not those specific to your installation. In the table, IM= induction motor; PM= permanent magnet motor.

**Table 2.4 TorqMax F5 Parameters**

Display	Parameter Description	Unit	Range	Default	Factory
<b>WARNING: Do not change drive parameters while the elevator is running. Incorrect drive parameter values can cause erratic operation.</b>					
<b>WARNING: Parameters with an asterisk (*) must be set correctly for your specific motor / machine / job. Refer to the adjustment manual for detailed information.</b>					
LF. 2	Signal operating mode: AbSPd - Absolute Analog Speed d SPd - Digital Speed Selection A tor - Analog Torque Control A Spd - Analog Speed Control SerSP - Serial Com. Speed Control bnSPd - Binary Speed Selection S POS - Serial Position feedback	-	AbSPd d Spd A tor A Spd SerSP BnSPd S POS	bnSPd	SerSP
LF. 3	Drive configuration: run- run mode conF - Configuration (5 minute time limit) Stop - Drive stopped, Motor cannot run. Drive will not respond. When using serial com, this mode allows parameter changes S Lrn - activate auto tune I Lrn - Inertia Learn. Learns the system inertia and activates the FFTC. P Lrn: Pole Learn. Learn the pole positions of PM Motor SPI - Stationary Pole Learn. Learn absolute encoder position for PM machine under brake without sheave movement. (N/A for software Version 1.61) OStST - Over speed test function. Allows car to over speed machine to test governor. (N/A for software Version 1.61)	-	run conF Stop S Lrn I Lrn P Lrn SPI OStST	conF	run
LF. 4	Motor-selection: Displays mode selected using US. 4 and US.10 ICLSD - Close loop induction I9LSS = Closed loop induction gearless PCLSD = Closed loop permanent magnet (PM) P9LSS = Closed loop PM gearless	-	see US.10	-	***
LF. 5	Drive fault auto reset	1	0 - 10	5	5
LF. 8	Electronic motor overload protection	-	on, off	off	on
LF. 9	IM - Electronic overload current PM - not visible, auto set same as LF.12	A	1.0 - 110% Drive rated	8.0	*
LF.10	IM - Rated motor power PM - read only, auto calc.	HP	0.00 - 125.00	5.00	*
LF.11	Rated motor speed	rpm	10.0 - 6000.0	1165 or 150	*
LF.12	Rated motor current	A	1.0 - 110% Drive rated	8.0	*
LF.13	Rated motor frequency	Hz	4.0 - 100.0	60.0	*
LF.14	Rated motor voltage IM - Name plate rated voltage PM - No-load, phase-to-phase back EMF rms voltage at LF.11	V	IM: 120 - 500V  PM: 1 - 32000V/krpm	230/460	*

Table 2.4 TorqMax F5 Parameters

Display	Parameter Description	Unit	Range	Default	Factory
LF.15	IM: Power factor, PM: not visible	1	0.50 - 1.00	0.90	0.90
LF.16	IM: Field weakening speed, PM: not visible	rpm	0.0 - 6000.0	set @ 80% of LF.11	*
LF.17	Rated motor torque, IM - read only, auto calc. PM - enter motor name plate torque	lb ft	1 - 10000	IM - calc. PM - 18	IM - *** PM *
LF.18	PM: Motor stator resistance - from data sheet or learn procedure (see F5 Drive manual) IM: not visible	ohm	0.0 - 49.999	49.999	PM *
LF.19	PM: Motor leakage inductance - from data sheet or learn procedure (see F5 Drive manual) IM: not visible	mH	0.01 - 500.00	1.00	PM *
LF.20	Contract speed	fpm	0 - 1600	0	*
LF.21	Traction sheave diameter (measured value)	inch	7.00 - 80.00	24.00	*
LF.22	Gear reduction ratio	1	1.00 - 99.99	30.00	*
LF.23	Roping ratio	1	1 - 8	1	*
LF.24	Load weight	lbs	0 - 30000	0	*
LF.25	Estimated gear ratio: Read only, auto calc.	0.01	1.00 - 99.99	-	***
0.LF.26	Encoder Interface: displays feedback type	-	-	-	***
LF.27	Encoder pulse number For InclE and SinCo reference to customer data For HIPEr set to 1024 For EndAt set to 2048	ppr	256 - 16384	1024	
LF.28	Encoder channel swap / direction 0 nothing reversed 1 encoder A<B>B swapped 2 motor rotation reversed 3 motor rotation reversed, A<B>B swapped	1	0 - 3	0	* 0
LF.29	Encoder sample time (recommend gearless = 4, geared = 8)	mSec	0.5 - 32	4	*
LF.30	Control mode 0, 1Open loop induction motor operation 2 -Closed loop speed control (LF. 2 = A Spd) 3 -Closed loop speed control with pre-torque 4 -Closed loop torque control (LF. 2 = A tor) 5 - Close loop speed control with synthesized pre-torque	1	0 - 5	0	*
A.LF.31	Kp speed accel: Proportional gain, accel & run	1	1 - 50396	3000	** 3000
d.LF.31	Kp speed decel: Proportional gain, decel	1	1 - 50396	3000	** 3000
P.LF.31	Kp speed torque (Synth. Pre-torque)	1	1 - 50396	2000	2000
A.LF.32	Ki speed accel: Integral gain, accel & run	1	1 - 26214	350	** 350
d.LF.32	Ki speed decel: Integral gain, decel	1	1 - 26214	250	** 250
P.LF.32	KI speed torque (Synth. Pre-torque)	1	1 - 26214	10000	10000
A.LF.33	Ki speed offset accel: Gain at low speed, accel	1	0 - 8000	3000	** 3000
d.LF.33	Ki speed offset decel: Gain at low speed, decel	1	0 - 8000	1000	** 1000
0.LF.36	Maximum torque ( <b>Auto calc by the drive</b> ).	lb ft	0 - 500%Trtd	Calculated	***
1.LF.36	Maximum torque emergency operation (=LF.17)	lb ft	0 - 500%Trtd	Calculated	***
LF.37	Open loop torque boost: Open loop op. only	%	0 - 25.5	5.0	5.0
LF.38	Carrier frequency; 0 = 8 KHz, 1 = 16KHz (Note: set LF.38 = 0 if E.OL2 error on drive)	1	0, 1	0	*

**Table 2.4 TorqMax F5 Parameters**

Display	Parameter Description	Unit	Range	Default	Factory
LF.41	Leveling speed (Not used, must set to 0)	fpm	0 - 25	0.0	0.0
LF.42	High speed (Not used, must set to 0)	fpm	0.0 - LF.20	0.0	0.0
LF.43	Inspection speed (Not used, must set to 0)	fpm	0.0 - 150.00	0.0	0.0
LF.44	High leveling speed (Not used, must set to 0)	fpm	0.0 - LF.20	0.0	0.0
LF.45	Earthquake Speed (Not used, must set to 0)	fpm	0.0 - 150.0	0.0	0.0
LF.46	Emergency Pwr Speed (Not used, must set to 0)	fpm	0.0 - LF.20	0.0	0.0
LF.47	Intermediate speed (Not used, must set to 0)	fpm	0.0 - LF.20	0.0	0.0
LF.49	Over speed function Test (N/A for SW Version 1.61)	fpm	1- 2400	100	100
0.LF.50	Profile 0 - Starting jerk (not used)	ft/s <sup>3</sup>			OFF
0.LF.51	Profile 0 - Acceleration (not used)	ft/s <sup>2</sup>			OFF
0.LF.52	Profile 0 - Acceleration jerk (not used)	ft/s <sup>3</sup>			OFF
0.LF.53	Profile 0 - Deceleration jerk (not used)	ft/s <sup>3</sup>			OFF
0.LF.54	Profile 0 - Deceleration (not used)	ft/s <sup>2</sup>			OFF
0.LF.55	Profile 0 - Approach jerk (not used)	ft/s <sup>3</sup>			OFF
1.LF.50	Profile 1 - Starting Jerk (not used)	ft/s <sup>3</sup>			OFF
1.LF.51	Profile 1 - Acceleration (not used)	ft/s <sup>2</sup>			OFF
1.LF.52	Profile 1 - Acceleration jerk (not used)	ft/s <sup>3</sup>			OFF
1.LF.53	Profile 1 - Deceleration jerk (not used)	ft/s <sup>3</sup>			OFF
1.LF.54	Profile 1 - Deceleration (not used)	ft/s <sup>2</sup>			OFF
1.LF.55	Profile 1 - Approach jerk (not used)	ft/s <sup>3</sup>			OFF
2.LF.50	Profile 2 - Starting jerk (not used)	ft/s <sup>3</sup>			OFF
2.LF.51	Profile 2 - Acceleration (not used)	ft/s <sup>2</sup>			OFF
2.LF.52	Profile 2 - Acceleration jerk (not used)	ft/s <sup>3</sup>			OFF
2.LF.53	Profile 2 - Deceleration jerk (not used)	ft/s <sup>3</sup>			OFF
2.LF.54	Profile 2 - Deceleration (not used)	ft/s <sup>2</sup>			OFF
2.LF.55	Profile 2 - Approach jerk (not used)	ft/s <sup>3</sup>			OFF
LF.56	Stop jerk (not used)	ft/s <sup>3</sup>			OFF
LF.57	Speed following error (0 = off, 1 = on,)	1	off, on	1	1
LF.58	Speed difference	%	0 - 30	10	10
LF.59	Trigger time speed difference: Following error timer	sec	0.0 -1.0	1.0	1.0
LF.61	Emergency operation mode. If using an MCE TAPS, (Traction Auxiliary Power Supply) this must be set to di1.		Off, SPd1, SPd2, SPd3, di1	off	off (di1 if TAPS used)
LF.67	Pre-torque gain	-	0.25 - 2.00	1.00	1.00
LF.68	Pre-torque offset	%	-100.0 - 100.0	0.00	0.00
LF.69	Pre-torque direction (0, 1 = +V, -1 = -V)	1	0, 1, -1	1	1
LF.70	Speed pick delay (Delay to turn on DRO)	sec	0.0 - 3.0	0.30	0.30
LF.71	Brake pick delay	sec	0.0 - 3.0	0.05	0.05
LF.76	Encoder resolution multiplier 2 for incremental encoder 8 for Sin/Cos, EnDat or Hiperface encoder	1	0 - 13	2	
LF.77	Absolute encoder position (measured)	1	0 - 65535h	0	*0



Table 2.4 TorqMax F5 Parameters

Display	Parameter Description	Unit	Range	Default	Factory
LF.78	Brake drop delay. Time motor will hold full current and control after direction inputs drop.	sec	0.00 - 3.00	0.50	0.50
LF.79	Current hold time. Delay in turning off the drive (Delay to turn OFF the motor current after the direction is dropped and LF.78 has expired)	sec	0.00 - 3.00	0.30	0.30
Diagnostic Parameters (Read only)					
LF.25	Estimated gear ratio	1			
LF.80	Software version	-			
LF.81	Software date	-			
LF.82	X2A input state	-	see tables in F5 Drive Manual		
LF.83	X2A output state	-			
LF.86	Operation mode	-			
LF.87	Actual inverter load (100% = rated load)	%			
LF.88	Motor command speed	rpm			
LF.89	Actual motor speed	rpm			
LF.90	Actual elevator speed	ft/m			
LF.93	Phase current	A			
LF.94	Peak phase current	A			
LF.95	Actual DC voltage	V			
LF.96	Peak DC voltage	V			
LF.97	Actual output frequency	Hz			
O.LF.98	Last error	-			
US Parameters					
US. 1	Password: With different passwords different parameter groups can be accessed for advanced programming.	-	-	-	-
US. 3	Load defaults: Select LoAd and press ENTER to cause all LF parameters to be reset to drive default values.	-	LoAd	-	
US. 4	Load configuration: Select LoAd and press ENTER to load the configuration selected in US.10.	-	LoAd	-	
US.10	Select configuration: Selects the drive mode. ICLSd - Close loop induction I9LSS = Closed loop induction gearless PCLSd = Closed loop permanent magnet (PM) P9LSS = Closed loop PM gearless	-	ICLSd I9LSS PCLSd P9LSS	-	*
US.34	Analog Pattern Gain	-	0.01-20.0	1.0	
US. 35	Reference Splitting: This function creates a slope between two successive serially transmitted speed values. This parameter should be adjusted for a time double the actual serial update rate of the speed command <b>Note:</b> Program to 40 msec for M4000 controller with Rev8	mSec	0 -200 mSec	0.0	40
* Parameters are motor / machine / job dependent. ** Recommended but field adjustable. *** The value is automatically calculated from the motor data or other parameter values.					
Parameters for Drive Software Version (LF 80 Drive Software = 1.61 with LF.81 date code = 2801.9 or later) or (LF 80 Drive Software = 1.71 with LF.81 date code = 704.0 or later.					

### Magnetek AC Drive Parameters

With the exception of those parameters listed earlier (Magnetek Motor/Encoder Setup Overview on page 2-26), all Magnetek parameters should be left at default values.



Before changing any A5 Motor Menu parameters, make sure the A5 Motor ID parameter is set. Setting Motor ID loads nominal values into select parameters in the A5 menu.

The following drive parameter table is included for your convenience and in the event the table shipped with the controller is not available. In any case, you should use the table to verify all settings on the elevator drive.

**Table 2.5 Magnetek AC Drive Table**

#	Display	Parameter Description	Unit	Range	Defaults	Factory
<b>Adjust A0</b>						
<b>A1</b>	<b>Drive</b>					
	Contract Car Spd	Elevator Contract Speed	fpm	0 - 1500	400	
	Contract Mtr Spd	Motor Speed at elevator contract speed	rpm	50 - 3000	1130	
	Response	Speed regulator sensitivity. If set too high, motor current and speed will be jittery. If too small, the motor will be sluggish.	rad/sec	1.0 - 20.0	10	10
	Inertia	System inertia	sec	0.25 - 50.00	2.0	2.0
	Inner Loop Xover	Inner speed loop crossover frequency (only with Ereg speed regulator)	rad/sec	0.1 - 20.0	2.0	2.0
	Gain Reduce Mult	Speed regulator response percentage to use in low gain Mode. 100% = no reduction.	%	10 - 100	100	100
	Gain Chng Level	Speed level to change to low gain mode (only with internal gain switch)	%	0 - 100.0	100	100
	Tach Rate Gain	Compensates for rope resonance. Use only after A1, Inertia, and A1, Response, have been set correctly.	%	0 - 30.0	0	0
	Spd Phase Margin	Phase margin of speed regulator (only with PI speed regulator)	o	45 - 90	80	80
	Ramped Stop Time	Time to ramp from rated torque to zero (only with torque ramp down stop function)	sec	0 - 2.50	0.20	0.20
	Contact Flt Time	Time before a contactor fault is declared	sec	0.10 - 5.00	0.50	0.80
	Brake Pick Time	Time before a brake pick fault is declared	sec	0 - 5.00	1.00	0.0
	Brake Hold Time	Time before a brake hold fault is declared	sec	0 - 5.00	0.20	0.20
	Overspeed Level	Threshold for detection of overspeed fault	%	100.0 - 150.0	115.0	115.0
	Overspeed Time	Time before an overspeed fault is declared	sec	0 - 9.99	1.00	1.00
	Overspeed Mult	Multiplier for overspeed test (U4)	%	100 - 150	125	125
	Encoder Pulses	Encoder counts per revolution	ppr	600 - 10000	1024	
	Spd Dev Lo Level	Range around the speed reference for speed deviation low logic output	%	00.1 - 10.0	10	10
	Spd Dev Time	Time before speed deviation low logic output is true	sec	0 - 9.99	0.5	0.5

Table 2.5 Magnetek AC Drive Table

#	Display	Parameter Description	Unit	Range	Defaults	Factory
	Spd Dev Hi Level	Level for declaring speed deviation alarm	%	0 - 99.9	10.0	10.0
	Spd Command Bias	Subtracts an effective voltage to actual speed command voltage	volts	0 - 6.00	0.00	0.00
	Spd Command Mult	Scales analog speed command	-	0.90 - 5.00	1.00	1.43
	Pre Torque Bias	Subtracts an effective voltage to actual pre torque command voltage	volts	0 - 6.00	0.00	0.00
	Pre Torque Mult	Scales pre-torque command	-	-10.00-10.00	1.00	1.00
	Zero Speed Level	Threshold for zero speed logic output	%	0 - 99.99	1.00	1.00
	Zero Speed Time	Time before zero speed logic output is declared true	sec	0 - 9.99	0.10	0.10
	Up/Dwn Threshold	Detection threshold, up or down direction	%	0 - 9.99	1.00	1.00
	Mtr Torque Limit	Motoring torque limit. Torque Limit LED will light when this limit is reached.	%	0 - 275.0	200.0	200.0
	Regen Torq Limit	Regenerating torque limit. Torque Limit LED will light when this limit is reached.	%	0 - 275.0	200.0	200.0
	Flux Wkn Factor	Defines torque limit at higher speeds	%	60.0 - 100.0	100.0	100
	Ana 1 Out Offset	Subtracts an effective voltage to actual analog output 1	%	-99.9 - 99.9	0.00	0.00
	Ana 2 Out Offset	Subtracts an effective voltage to actual analog output 2	%	-99.9 - 99.9	0.00	0.00
	Ana 1 Out Gain	Scaling factor for analog output 1	-	0 - 10.0	1.0	1.0
	Ana 2 Out Gain	Scaling factor for analog output 2	-	0 - 10.0	1.0	1.0
	Flt Reset Delay	Time Before a fault is automatically reset	sec	0 - 120	5	5
	Flt Reset / Hour	Number of faults allowed to reset automatically per hour	fault	0 - 10	3	3
	Up to SPD. Level	The logic output function is true when the motor speed is above the user specified speed defined here	%	0 - 110.00	080.00	080.00
	Mains DIP Speed	When enabled by the Main DIP Speed (A1) parameter, speed is reduced by this percent when an undervoltage alarm is declared	%	5 - 99.9	25.00	25.00
	Run Delay Timer	Delays drive recognition of RUN signal.	sec	0.00 - 0.99	0.00	0.00
	AB Zero Spd Lev	Auto Brake Function - N/A to MCE products	%	0.00 - 2.00	0.00	0.00
	AB Off Delay	N/A to MCE products	sec	0.00 - 9.99	0.00	0.00
	Contactors DO Dly	N/A to MCE products	sec	0.00 - 5.00	0.00	0.00
	TRQ Lim Msg Dly	Time duration drive is in torque limit before Hit Torque Limit message displayed.	sec	0.00 - 10.00	0.50	0.50
	SER2 INSP SPD	Defines the serial mode 2 Inspection (only serial mode 2)	ft/ min	0 - 100	30	30
	SER2 RS CRP SPD	Creep speed used in "rescue mode"	ft/ min	0 - 300	10	10
	SER2 RS CPR Time	Maximum time drive will continue to run at rescue creep speed (only serial mode 2)	sec	0 - 200	180	180
	SER2 FLT TOL	Maximum time that may elapse between valid run time messages before a serial fault is declared (only serial mode 2)	sec	0.0 - 2.0	0.04	0.04
	Rollback Gain	Ant-rollback gain	-	1 - 20	1	1

**Table 2.5 Magnetek AC Drive Table**

#	Display	Parameter Description	Unit	Range	Defaults	Factory
	Notch Filter Frq	Notch Filter Center Frequency	Hz	5 - 60	20	20
	Notch Filt Depth	Notch filter maximum attenuation	%	0 - 100	0	0
	MSPD Delay 1-4	Recognition time delay for a defined multistep speed command	sec	0.00 - 10.0	0.00	0.00
<b>A2 S-Curves</b>						
	Accel Rate 0	Acceleration rate #0	ft/s <sup>2</sup>	0 - 7.99	3.00	0.00
	Decel Rate 0	Deceleration rate #0	ft/s <sup>2</sup>	0 - 7.99	3.00	0.00
	Accel Jerk in 0	Rate of increase of acceleration, up to ACCEL Rate, when increasing elevator speed	ft/s <sup>3</sup>	0 - 29.9	8.0	0.0
	Accel Jerk out 0	Rate of decrease of acceleration to zero when approaching contract elevator speed	ft/s <sup>3</sup>	0 - 29.9	8.0	0.0
	Decel Jerk in 0	Rate of increase of deceleration, up to Decel Rate, when decreasing elevator speed	ft/s <sup>3</sup>	0 - 29.9	8.0	0.0
	Decel Jerk out 0	Rate of decrease of deceleration to zero when slowing the elevator to leveling speed	ft/s <sup>3</sup>	0 - 29.9	8.0	0.0
	Accel Rate 1	Acceleration rate #1	ft/s <sup>2</sup>	0 - 7.99	3.00	0.0
	Decel Rate 1	Deceleration rate #1	ft/s <sup>2</sup>	0 - 7.99	3.00	0.0
	Accel Jerk in 1	Rate of increase of acceleration, up to ACCEL Rate, when increasing elevator speed	ft/s <sup>3</sup>	0 - 29.9	8.0	0.0
	Accel Jerk out 1	Rate of decrease of acceleration to zero when approaching contract elevator speed	ft/s <sup>3</sup>	0 - 29.9	8.0	0.0
	Decel Jerk in 1	Rate of increase of deceleration, up to Decel Rate, when decreasing elevator speed	ft/s <sup>3</sup>	0 - 29.9	8.0	0.0
	Decel Jerk out 1	Rate of decrease of deceleration to zero when slowing the elevator to leveling speed	ft/s <sup>3</sup>	0 - 29.9	8.0	0.0
	Accel Rate 2	Acceleration rate #2	ft/s <sup>2</sup>	0 - 7.99	3.00	0.00
	Decel Rate 2	Deceleration rate #2	ft/s <sup>2</sup>	0 - 7.99	3.00	0.00
	Accel Jerk in 2	Rate of increase of acceleration, up to ACCEL Rate, when increasing elevator speed	ft/s <sup>3</sup>	0 - 29.9	8.0	0.0
	Accel Jerk out 2	Rate of decrease of acceleration to zero when approaching contract elevator speed	ft/s <sup>3</sup>	0 - 29.9	8.0	0.0
	Decel Jerk in 2	Rate of increase of deceleration, up to Decel Rate, when decreasing elevator speed	ft/s <sup>3</sup>	0 - 29.9	8.0	0.0
	Decel Jerk out 2	Rate of decrease of deceleration to zero when slowing the elevator to leveling speed	ft/s <sup>3</sup>	0 - 29.9	8.0	0.0
	Accel Rate 3	Acceleration rate #3	ft/s <sup>2</sup>	0 - 7.99	3.00	0.00
	Decel Rate 3	Deceleration rate #3	ft/s <sup>2</sup>	0 - 7.99	3.00	0.00
	Accel Jerk in 3	Rate of increase of acceleration, up to ACCEL Rate, when increasing elevator speed	ft/s <sup>3</sup>	0 - 29.9	8.0	0.0
	Accel Jerk out 3	Rate of decrease of acceleration to zero when approaching contract elevator speed	ft/s <sup>3</sup>	0 - 29.9	8.0	0.0
	Decel Jerk in 3	Rate of increase of deceleration, up to Decel Rate, when decreasing elevator speed	ft/s <sup>3</sup>	0 - 29.9	8.0	0.0
	Decel Jerk out 3	Rate of decrease of deceleration to zero when slowing the elevator to leveling speed	ft/s <sup>3</sup>	0 - 29.9	8.0	0.0

Table 2.5 Magnetek AC Drive Table

#	Display	Parameter Description	Unit	Range	Defaults	Factory
<b>A3 Multistep Ref</b>						
	Speed Command 1	Multi-Step Speed command #1	ft/m	-3000.0-3000.0	0	0
	Speed Command 2	Multi-Step Speed command #2	ft/m	-3000.0-3000.0	0	0
	Speed Command 3	Multi-Step Speed command #3	ft/m	-3000.0-3000.0	0	0
	Speed Command 4	Multi-Step Speed command #4	ft/m	-3000.0-3000.0	0	0
	Speed Command 5	Multi-Step Speed command #5	ft/m	-3000.0-3000.0	0	0
	Speed Command 6	Multi-Step Speed command #6	ft/m	-3000.0-3000.0	0	0
	Speed Command 7	Multi-Step Speed command #7	ft/m	-3000.0-3000.0	0	0
	Speed Command 8	Multi-Step Speed command #8	ft/m	-3000.0-3000.0	0	0
	Speed Command 9	Multi-Step Speed command #9	ft/m	-3000.0-3000.0	0	0
	Speed Command 10	Multi-Step Speed command #10	ft/m	-3000.0-3000.0	0	0
	Speed Command 11	Multi-Step Speed command #11	ft/m	-3000.0-3000.0	0	0
	Speed Command 12	Multi-Step Speed command #12	ft/m	-3000.0-3000.0	0	0
	Speed Command 13	Multi-Step Speed command #13	ft/m	-3000.0-3000.0	0	0
	Speed Command 14	Multi-Step Speed command #14	ft/m	-3000.0-3000.0	0	0
	Speed Command 15	Multi-Step Speed command #15	ft/m	-3000.0-3000.0	0	0
<b>A4 Power Convert</b>						
	Id Reg Diff gain	Flux Current regulator differential gain	-	0.80 - 1.20	1.00	1.00
	Id Reg Prop Gain	Flux current regulator proportional gain	-	0.20 - 0.40	0.30	0.30
	Iq Reg Diff Gain	Torque current regulator differential gain	-	0.80 - 1.20	1.00	1.00
	Iq Reg Prop Gain	Torque current regulator proportional gain	-	0.20 - 0.40	0.30	0.30
	PWM Frequency	Carrier frequency	kHz	2.5 - 16.0	10.0	10.0
	UV Alarm Level	Level for undervoltage alarm	%	80 - 99	80	90
	UV Fault Level	Level for undervoltage fault	%	50 - 88	80	80
	Extern Reactance	External choke reactance	%	0 - 10	0	0
	Input L-L Volts	Nominal line-line AC input Voltage, RMS	volts	110 - 480	Drive dep.	
<b>A5 Motor</b>						
	Motor ID	Motor Identification	-	4 Pole DFLT, 6 Pole DFLT		
	Rated Mtr Power	Rated motor output power	HP	1.0 - 500	0.0	
	Rated Mtr Volts	Rated motor terminal RMS voltage	volts	190.0 - 575.0	0.0	
	Rated Excit Freq	Rated excitation frequency	Hz	5.0 - 400.0	0.0	
	Rated Motor Curr	Rated motor current	amps	1.00 - 800.00	0.00	
	Motor Poles	Motor poles	-	2 - 32	0	
	Rated Mtr Speed	Rated motor speed at full load	RPM	5.0 - 3000.0	0.0	
	% No Load Curr	Percent no load current	%	10.0 - 80.0	Per ID	
	Stator Leakage X	Stator leakage reactance	%	0 - 20.0	Per ID	
	Rotor Leakage X	Rotor leakage reactance	%	0 - 20.0	Per ID	
	Stator Resist	Stator resistance	%	0 - 20.0	1.5	1.5
	Motor Iron Loss	Iron loss at rated frequency	%	0 - 15.0	0.5	0.5
	Motor Mech Loss	Mechanical loss at rated frequency	%	0 - 15.0	1.0	1.0
	Ovld Start Level	Maximum continuous motor current	%	100 - 150	110	110

**Table 2.5 Magnetek AC Drive Table**

#	Display	Parameter Description	Unit	Range	Defaults	Factory
	Ovld Time Out	Time that defines motor overload curve	sec	5.0 - 120.0	60.0	60.0
	Flux Sat Break	Flux saturation curve slope change point	%	0 - 100	75	75
	Flux Sat Slope 1	Flux saturation curve slope for low fluxes	%	0 - 200.0	0	0
	Flux Sat Slope 2	Flux saturation curve slope for high fluxes	%	0 - 200.0	50	50
<b>Configure C0</b>						
<b>C1</b>	<b>User Switches</b>					
	Spd Command Src	Speed Command Source	-	Analog input Multi-step Serial multi-step Serial	Multi-step	Serial
	Run Command Src	Run Command Source	-	External TB Serial Serial+extern	External TB	Serial
	Hi/Lo Gain Src	High / low gain change switch source	-	External TB Serial Internal	Internal	Internal
	Speed Reg Type	Chooses speed regulator	-	Elev spd reg Pi speed reg External reg	Elev spd reg	Elev spd reg
	Motor Rotation	Allows user to reverse direction of motor rotation	-	Forward Reverse	Forward	Forward or Reverse
	Spd Ref Release	Determines when speed reference release is asserted	-	Reg release Brake picked	Reg release	Reg release
	Cont Confirm Src	Enables external logic input for contactor confirmation.	-	None External TB	None	External TB
	Pre Torque Source	Enables and determines the source of the pre torque command	-	None Analog input Serial	None	Serial
	Pre Torque Latch	Determines if analog pre-torque command is latched	-	Not latched Latched	Not latched	Not Latched
	PT torq Latch Clck	Determines source of pre torque latch control (if used)	-	External TB Serial	External tb	External TB
	Fault Reset Src	Fault reset source	-	External TB Serial Automatic	External tb	Serial
	Overspd Test Src	Determines external logic source to trigger overspeed test	-	External TB Serial	External tb	External tb
	Brake Pick Src	If drive controls mechanical brake, determines source of brake pick command	-	Internal Serial	Internal	Internal
	Brake Pick Cnfrm	Enables a logic input to use for brake pick confirmation	-	None External TB Internal time	None	None
	Brake Hold Src	If drive controls mechanical brake, determines source of brake hold command	-	Internal Serial	Internal	Internal
	Ramped Stop Sel	Selects normal stop or torque ramp down stop	-	None Ramp on stop	None	Ramp on Stop

Table 2.5 Magnetek AC Drive Table

#	Display	Parameter Description	Unit	Range	Defaults	Factory
	Ramp Down En Src	Determines the source that signals the torque ramp down stop (if used)	-	External TB Run logic Serial	External tb	Run Logic
	Brk Pick Flt Ena	Brake pick fault enable	-	Enable Disable	Disable	Disable
	Brk Hold Flt Ena	Brake hold fault enable	-	Enable Disable	Disable	Disable
	Ext Torq Cmd Src	When Speed Reg Type = External Reg, sets the source of the torque command	-	None Serial Analog input	None	None
	Dir Confirm	Confirms proper analog signal polarity when enabled and a logic input is programmed to Run Up and Run Down	-	Enabled Disabled	Disabled	Disable
	S-Curve Abort	Addresses how the S-Curve Speed Reference Generator handles a reduction in the speed command before the S-Curve Generator has reached its target speed.	-	Enabled Disabled	Disabled	Disable
	Fast Flux	Reduces starting takeoff time by reducing motor fluxing time	-	Enabled Disabled	Disabled	Disabled
	Main DIP Ena	Enables the Mains DIP Speed (A1) parameter that reduces speed when an undervoltage alarm is declared	-	Enabled Disabled	Disabled	Disable
	DB Protection	Dynamic braking Protection fault or alarm selection		Fault Alarm	Fault	Fault
	Encoder Fault	Temporarily disables the Encoder Fault	-	Enabled Disabled	Enabled	Enable
	Stopping Mode	Determines stopping mode when Spd Command Src = multi-step	-	Immediate Ramp to stop	Immedi- ate	Immedi- ate
	Motor OvrlD Sel	Motor Overload Selection	-	Alarm Flt Immediate Fault at Stop	Alarm	Fault at stop
	Auto Stop	Auto Stop Function enable	-	Disable Enable	Disable	Disable
	Serial Mode	Serial Protocol selection	-	None Mode 1 Mode 2 Mode 2 test	None	Mode 1
	SER2 FLT Mode	Defines reaction to a serial communication fault while in Serial Mode 2 (Only serial mode 2)	-	Immediate Run remove rescue	Immedi- ate	Immedi- ate
	DRV Fast Disable	Addresses how fast the drive responds to the removal of Drive Enable logic input.	-	Disable Enable	Disable	Disable
	MLT-SPD to DLY1	Assigns multi-step speed command to recognition delay timer 1	-	None mspd1- mspd15	None	None
	MLT-SPD to DLY2	Assigns multi-step speed command to recognition delay timer 1	-	None mspd1- mspd15	None	None

**Table 2.5 Magnetek AC Drive Table**

#	Display	Parameter Description	Unit	Range	Defaults	Factory
	MLT-SPD to DLY3	Assigns multi-step speed command to recognition delay timer 1	-	None mspd1- mspd15	None	None
	MLT-SPD to DLY4	Assigns multi-step speed command to recognition delay timer 1	-	None mspd1- mspd15	None	None
<b>C2 Logic Inputs</b>						
	Log In 1 TB1-1	Terminal 1 Selection	-	-	DRIVE ENABLE	DRIVE ENABLE
	Log In 2 TB1-2	Terminal 2 Selection	-	-	RUN	CON- TACT CFIRM
	Log In 3 TB1-3	Terminal 3 Selection	-	-	FAULT RESET	
	Log In 4 TB1-4	Terminal 4 Selection	-	-	UP/DWN	NO FUNC- TION
	Log In 5 TB1-5	Terminal 5 Selection	-	-	S-CURVE SEL 0	NO FUNC- TION
	Log In 6 TB1-6	Terminal 6 Selection	-	-	STEP REF B0	NO FUNC- TION
	Log In 7 TB1-7	Terminal 7 Selection	-	-	STEP REF B1	NO FUNC- TION
	Log In 8 TB1-8	Terminal 8 Selection	-	-	STEP REF B2	NO FUNC- TION
	Log In 9 TB1-9	Terminal 9 Selection	-	-	EXTERN FAULT 1	NO FUNC- TION
<b>C3 Logic Outputs</b>						
	Log Out 1 tb1-14	Terminal 14 Selection	-	-		READY TO RUN
	Log Out 2 tb1-15	Terminal 15 Selection	-	-	RUN COM- MAND	RUN COM- MAND
	Log Out 3 tb1-16	Terminal 16 Selection	-	-	MTR OVER- LOAD	SPEED REG RLS
	Log Out 4 tb1-17	Terminal 17 Selection	-	-	ENCODER FAULT	RAMP DOWN EN
	Relay Coil 1	Relay 1 Function Selection	-	-	FAULT	READY TO RUN
	Relay Coil 2	Relay 2 Function Selection	-	-	SPEED REG RLS	SPEED REG RLS





## Required Controller Parameter Settings

Before attempting to move the car, you must verify drive parameters as described in [Torqmax F5 AC Drive Parameters on page 2-31](#) or see “[Magnetek AC Drive Table](#)” on page 2-36.

### Acceleration and Deceleration Rates

Acceleration and deceleration rates are measured and programmed in  $\text{ft/s}^2$  (feet per second per second). Jerk parameters adjust the rate of transition from one speed to another and are measured and programmed in  $\text{ft/s}^3$  (feet per second per second per second). F7 control parameters correspond to curve locations as shown in the following figure. Increasing S-Curve values generally results in more aggressive runs and shorter flight times.

Figure 2.12 Motion 4000 Performance Curves

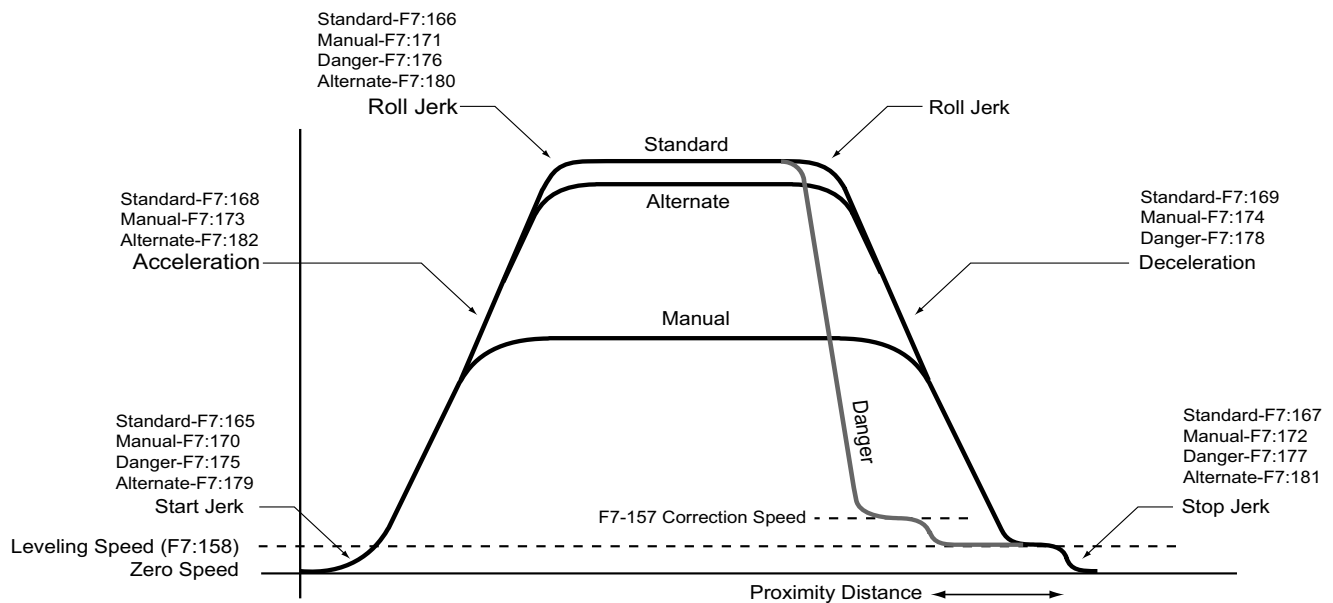

### Curves Used for Operating Speeds

The performance curves shown above and the operating speeds that use them are:

- Standard Curve: Contract, correction, earthquake, and leveling speed
- Alternate Curve: Conservation, and emergency power speed
- Manual Curve: Inspection and reduced inspection speed
- Danger “Curve”: Used for emergency deceleration

## The F7 Menu

Through the F7 menu, you learn the terminal switches, drive, and machine characteristics that influence speed and position computation. You start by uploading all parameters from the TC-MPI Motion Processor Interface board, then modify as necessary and save.

**Important** Once set at the factory, F7 parameters are protected by positioning a jumper on the HC-CTL board. Before you can access F7 parameters, you must set the jumper appropriately:

2



## Changing Parameters

1. Place the car on Inspection operation.
2. Set the F7 function switch to the up position.
3. The LCD will display:
  - Parameter adjust. Press Next to start. Press Select to resume.

**Next** Momentarily pressing Next (N) causes the MPU board to upload all parameters from the TC-MPI Motion Processor Interface board and display the first parameter.

**Select** Momentarily pressing Select (S) causes the MPU board display the parameter last viewed. This is intended to allow you to quickly access a parameter you are trying different adjustments with, save it, then run the car to see what the changes have done.

**Change** Use the + (plus) button to increment or the - (minus) button to decrement values. Once the value is set, momentarily press N (Next) to advance to the next parameter.

**Move Back** To move back to the previous parameter, press and hold N (Next), press - (minus), then release both buttons together.

## Saving Changes

- After setting desired parameters and with the car still on Inspection: Press S to initiate a save operation.

The parameter viewed when the Save was initiated will be remembered. This allows you to quickly access a parameter, modify it, save it, run the car to see the effect, then return to edit further if needed. Scrolling to the end of the motion parameters will also initiate a save.

- Once you have saved your changes, we recommend you re-position the jumper to protect F7 parameter settings.

**Controller Motion Parameters**

The following F7 parameters must be checked before you attempt to move the car.

**Table 2.6 F7 Menu Settings KEB/TorqMAX**

#	Item	Default	Recommended
148	Hoist-motor speed	+1165.0 rpm	Per Job
155	Inspection speed (normal)	+50 fpm	As desired
170	Manual start jerk	+1.00 ft/s <sup>3</sup>	+1.00 ft/s <sup>3</sup>
171	Manual roll jerk	+1.00 ft/s <sup>3</sup>	+1.00 ft/s <sup>3</sup>
172	Manual stop jerk	+1.00 ft/s <sup>3</sup>	+1.00 ft/s <sup>3</sup>
173	Manual acceleration	+0.50 ft/s <sup>2</sup>	+0.50 ft/s <sup>2</sup>
174	Manual deceleration	+0.50 ft/s <sup>2</sup>	+0.50 ft/s <sup>2</sup>
184	Drive type option	KEB F5-GRD50	KEB LF.80 = View LF.80 LF.80 = 1.71 or greater: F5-GRD50 (geared) or F5-GLS50 (gearless) LF.80 = Other: F5-GRD49 (geared) or F5-GLS49 (gearless)
185	Brake type option	DISCRETE	If the controller has a brake module(s): One Module or Two Modules If the controller has no brake module: Discrete
194	Normal brake pick voltage		Brake Module: Enter pick voltage No Brake Module: No effect

**Table 2.7 F7 Menu Settings Magnetek**

#	Item	Default	Recommended
133	Brake Pick Delay	0 ms	Job specific. Initially set to 0.0
134	Speed Pick Delay	+500 ms	Job specific, Initially set to 1.0
138	Drive Disable Delay	+1250 ms	1250
140	Profile Advance	+100 ms	Drive tuning specific. Initially set to 1 divided by Response. View response on A1 Magnetek drive menu.
142	Standard Slew Slope	+0.5 ft/s <sup>2</sup>	Drive tuning specific. Initially set to 2.0
148	Hoist-motor speed	+1165.0 rpm	Per Job
155	Inspection speed (normal)	+50 fpm	As desired
160	Leveling Distance	+1.0 in	Drive tuning specific. Initially set to 2.0
170	Manual start jerk	+1.00 ft/s <sup>3</sup>	+1.00 ft/s <sup>3</sup>
171	Manual roll jerk	+1.00 ft/s <sup>3</sup>	+1.00 ft/s <sup>3</sup>
172	Manual stop jerk	+1.00 ft/s <sup>3</sup>	+1.00 ft/s <sup>3</sup>
173	Manual acceleration	+0.50 ft/s <sup>2</sup>	+0.50 ft/s <sup>2</sup>
174	Manual deceleration	+0.50 ft/s <sup>2</sup>	+0.50 ft/s <sup>2</sup>
184	Drive type option	KEB F5-GRD50	MAG HPV600 for 600/600PM MAG HPV900 for 900/900PM/900II
185	Brake type option	DISCRETE	If the controller has a brake module(s): One Module or Two Modules If the controller has no brake module: Discrete
192	Speed Drop Delay		Drive tuning specific. Initially set to 900
193	Profile Compensation	Dynamic	Fixed
194	Normal brake pick voltage		Brake Module: Enter pick voltage No Brake Module: No effect

## Using Inspection Stations to Run

In inspection, a car operates at slow speed using up and down buttons. The car will stop when the buttons are released.

### Encoder Polarity (KEB, TorqMAX)

1. Place the car on Inspection mode.
2. Press and hold the ENABLE button while using the Direction toggle to run the car up or down. The brake and motor contactors should pick; the car should move.
3. Set drive parameter LF.93 to display motor current.
4. If the car oscillates at zero speed, moves at slow speed, or trips the E.ENCC drive fault, change drive parameter LF.28 (0 to/from 1) to internally swap encoder channels. If the motor draws normal current (LF.93 = 30 - 40% of motor FLA) but the car moves in the opposite of the direction commanded, set LF.28 to "2" to reverse motor rotation.

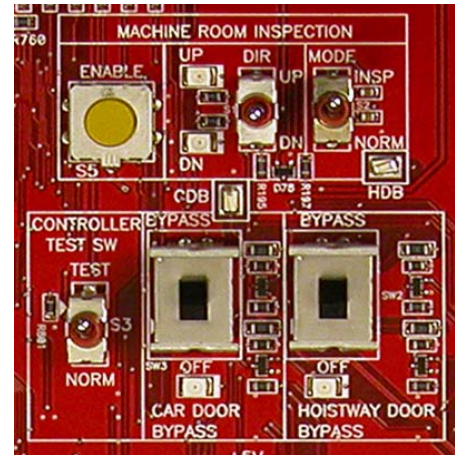

#### Note

KEB E.ENCC Fault: If a malfunction occurs, the drive shuts down and the display is overwritten with an error message. After correction, most errors can be cleared by pressing the Enter key. E.ENCC errors however can only be cleared through Parameter OLF.26. If the drive displays E.ENCC, refer to the LF.26 explanation in the drive manual.

### Align Encoder (Magnetek)

#### HPV 600/900/900II

1. Move the elevator on Inspection and verify that the motor is under control and rotating in the proper direction.

For proper operation, motor phasing must match encoder feedback phasing. If the phasing is not correct, the motor will not accelerate up to speed. It will typically oscillate back and forth at zero speed and the current will be at the torque limit.

2. If the motor operates as described above, verify that the encoder is wired as shown in the prints. If it is, swap any two motor phases.
3. If the motor operates properly but is turning in the wrong direction, change the Motor Rotation parameter in the drive C1 User Switches menu.

#### HPV 600PM

1. Place the controller on Inspection.
2. Set Inspection Speed (normal), controller F7, 155, to 1/8 of Contract Speed.
3. In the controller F3, Controller Utilities menu, set Inspection Mode Fault Bypass to ON. (Jumper must be in place on HC-CTL board Fault Reset Jumper J1.)
4. Refer to and follow the Absolute Encoder Alignment Procedure, Auto Alignment Procedure in the Magnetek HPV 600PM AC Drive technical manual.
5. Restore controller to original settings.

### HPV 900PM

1. Place the controller on Inspection.
2. Set controller F7, 141, Profile Scale to 0.0%.
3. In the controller F3, Controller Utilities menu, set Inspection Mode Fault Bypass to ON. (Jumper must be in place on HC-CTL board Fault Reset Jumper J1.)
4. Disable the machine brake. (Remove brake wire from brake coil if discrete brake circuit is being used or set the Normal Brake Pick/Hold Voltage (F7, 194 and 195) to 0.0 if a brake module is being used.)
5. Refer to and follow the Absolute Encoder Alignment, Alignment Via Car Controller procedure in the Magnetek HPV 900PM AC Drive technical manual.
6. Restore controller to original settings.

### Brake Basics

1. Ensure that the brake is picking cleanly. With the car set up so that it will not move:
  - Manually activate the PM and BR contactors to lift the brake.
  - Measure DC voltage between terminals B1 and B2. It should be very close to the pick voltage shown in your job prints.
  - Refer to job prints and adjust pick voltage if necessary.
2. Ensure that, when set, the brake is capable of holding 125% of rated car capacity. Refer to [Adjust Brake to 125% of Full Load on page 2-73](#).
3. Check that brake and motor coordination are such that the brake is dropping just when motor rotation stops.
4. Check that the brake pick delay allows the motor to build sufficient flux to prevent roll back when the car is starting.

### Verify Motor Speed, KEB/TorqMAX

If the car is not running at inspection speed as verified using a hand-held tachometer:

- Check the inspection speed setting (F7:155, [page 4-118](#))
- Check F7:141 Profile Scaling at 100%.
- Check motor speed is properly set, KEB LF.11.
- Verify traction sheave diameter and setting, KEB LF.21.
- Verify Closed Loop control setting KEB LF.30 is set to 2 (closed loop)
- Check F7:148 Hoist motor speed is properly set (increase = faster speed; decrease = slower speed). This value reflects the motor RPM at contract speed.
- If the ELGO landing system is installed, access the controller MPU, ELGO F3 menu and check that it shows the correct inspection speed. If not, set LF.22 to a value between 125% and 150% of LF.25. Adjust F7:148 Motor RPM to modify inspection speed.



#### Note

KEB: Drive parameters LF.20 Contract Speed, LF.21 Sheave diameter, and LF.11 Motor RPM determine the drive's Estimated Gear Ratio, LF.25. If problems reaching speed persist, make LF.22 = 150% of LF.25 value.

### Verify Motor Speed, Magnetek

If the car is not running at inspection speed as verified using a hand-held tachometer:

1. While running on Inspection, verify that the Speed Command on the drive D1 Elevator Data menu is equal to the controller requested F7, 155, Inspection Speed (Normal).
2. On the controller F3 menu, select the car speed display.
3. While running on Inspection, verify the actual speed via the controller LCD or a hand-held tachometer (controller LCD preferred). Adjust Contract Mtr Spd on the drive A1 Drive Menu if the speed is not correct (higher RPM for increased speed).
4. When the elevator is running at the correct speed, verify that the controller F5, MPI-C Diagnostic menu, address 17, Raw Speed Feedback, displays the correct value. If not, adjust controller V7, 148, Hoist Motor Speed (lower RPM = increased speed).

**Temporary Run Box Hookup.**

The following illustration shows a temporary run box hookup. Disconnect controller power before attempting to wire the run box. The temporary run box must have an enable button, an up button, a down button, and a stop (Insp/Norm) switch.



**Caution**

For safety, keep the controller Machine Room Inspection switch in the INSP position while the temporary run box is in use.



**Caution**

If a jumper was installed between HC-CTL board terminals SAFC and SAFH (Construction Mode Jumper Requirements on page 2-28), it must be removed when the temporary run box is connected.

**Figure 2.13 Temporary Run Box**

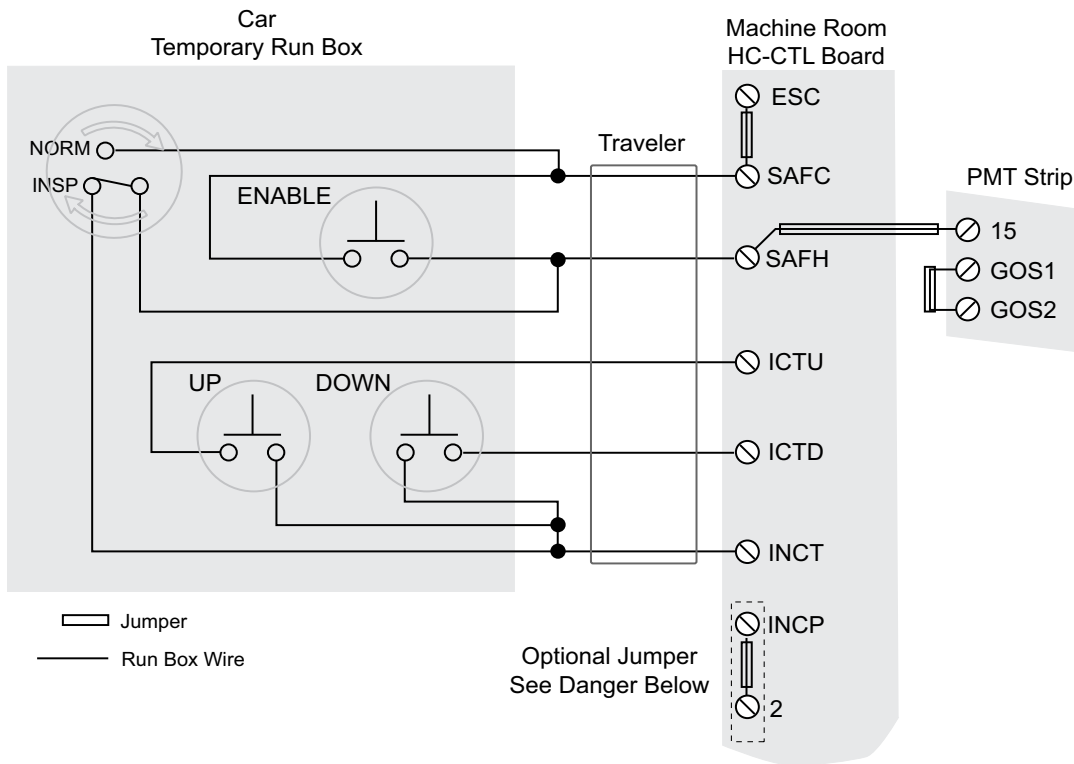

**Danger**

Wire the temporary run box as shown for safe operation. The jumper from 2 bus to INCP prevents the car from reverting to Normal mode if/when there is a loss of connection to INCT. Machine Room Inspection operation is prevented until the INCP/2 Bus jumper is removed. It is imperative that any temporary jumper installed in the controller be removed as soon as the equipment wiring it is simulating is in place. Temporary jumpers or wires may not be stored in the control room or space.



## Prepare for Inspection Operation

Once the car is running safely on construction operation, you should next install all safety string components in accordance with the job drawings package. The actual equipment in the string may vary from job to job but for the Motion 4000 generally includes:

- Hoistway safety string -
  - Governor switch
  - Final Limit switches
  - Buffer switches
  - Compensation sheave switch
  - Pit stop switch
- Cartop safety string -
  - Safety clamp switch
  - Emergency exit contact
  - Cartop Inspection station and Stop switch
  - In-Car Stop switch (in COP)
- Hoistway Switches

At this point, you should also:

- Install seismic equipment

## Hoistway Safety String

1. Install hoistway safety string devices as shown in your job prints.
2. Install final limit switches at each terminal.
3. Test each device individually after the string is complete to see that it does in fact open the safety string as it should.



In Motion 4000 installations, Final Limit switches are part of the hoistway safety string and should not open unless the car overruns the terminal landing.

## Cartop Safety String

1. Install the cartop inspection station and stop switch as shown in your job prints.
2. Install cartop safety string devices as shown in the job prints.
3. If the in-car stop switch is in place, wire it into the string as shown.
4. Verify that the cartop inspection controls work correctly.

## Hoistway Switches

### Virtual/Physical/Unused

With the exception of the final limit switches, which are always physical, other slowdown switches used in Motion 4000 installations may be physical, virtual, or unused:

- Physical: Normal switches installed in hoistway.
- Virtual: Switches placed in “software” by the positioning system. [Please refer to “Terminal Switch Options, 69 - 74” on page 4-109.](#)
- Unused: Depending upon car contract speed, some hoistway switch positions may be unused.

**Table 2.8 Hoistway Switch Requirements**

UETS/DETS and UNTSX/DNTSX switches requirement as per Rated speed (FPM)												
Car Speed (FPM)	UETS/DETS		UNTS1/DNTS1		UNTS2/DNTS2		UNTS3/DNTS3		UNTS4/DNTS4		UNTS5/DNTS5	
	Virtual switch	Learn speed	Virtual switch	Learn speed	Virtual switch	Learn speed	Virtual switch	Learn speed	Virtual switch	Learn speed	Virtual switch	Learn speed
Up to 399	√	80%	√	90%								
400-499	√	80%	√	70%	√	90%						
500-599	√	80%	√	60%	√	70%	√	90%				
600-699	√	80%	√	50%	√	60%	√	70%	√	90%		
>700	√	80%	√	40%	√	50%	√	60%	√	70%	√	90%

## Seismic Equipment

A “ring and string” circuit detects excessive counterweight motion caused by a seismic disturbance. When motion is detected, the car will make a full stop. After stopping, the car will move to and level at the next available floor in the direction away from the counterweight. After leveling, the car will open its doors and allow passengers to exit.

Modes of operation other than Automatic, for example Fire Phase II or Attendant mode, allow different operating options when potential counterweight derailment has been detected.

Your job may also use a lateral and/or vertical acceleration sensor to detect seismic activity. At this point, you should install counterweight movement detection and seismic sensors in accordance with your job prints and seismic monitor manufacturer instructions.

**Figure 2.14 Seismic Equipment**

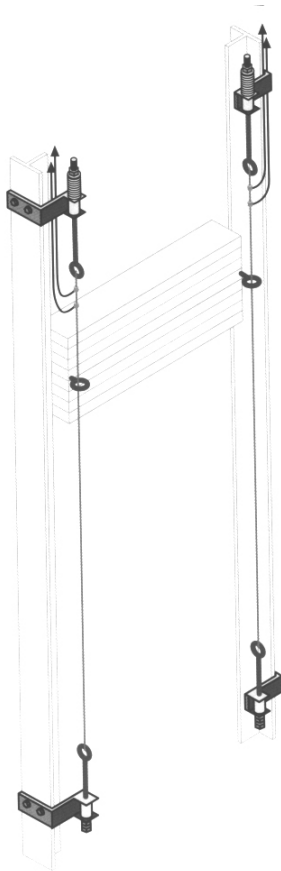

### Counterweight Displacement Kit:

Two steel cables run parallel to counterweight guide rails, passing through a pair of eyebolts on the counterweight. If the counterweight moves laterally, the cable touches the ring, completing the circuit and providing an alert to the controller.



### Seismic Detector:

Detects and records vertical and horizontal seismic movement. Peak acceleration along each axis is detected and stored for up to 15 seismic events. The easy to read LCD displays real time acceleration and angle of deflection.

## Running on Inspection Mode

At this point, you should be ready to turn the car over to standard Machine Room and/or Car-top Inspection operation. All equipment, with the exception of the landing/positioning system, the door operator, load weigher, hall call stations, and full car operating panel should now be installed and tested for proper function.



### Danger

Controller inspection warnings:

- As always when actively installing an elevator, have someone stand by the main line disconnect when power is applied or when initial attempts are made to move the car.
- Check all safety circuits are functional.
- Check all hoistway door interlocks are functional.
- Check car gate circuitry is functional.

Prior to Applying Power:

- Verify all circuits are wired to the controller properly.
- Check the following items:
  - Inspection switch to INSP
- Verify, with an ohmmeter, that the governor overspeed switch and any other devices that are wired in at this time will open the safety circuit.
- Physically verify that all hoistway doors are closed and locked.
- Verify that any temporary jumpers placed for equipment that has now been installed are removed.

## Controller Power Up

After powering up the controller, check the following:

1. If the LCD is displaying an error message, troubleshoot to resolve the issue. ([Please refer to Section 5.](#))
2. Check that the LCD displays INSPECTION.
3. Using the Enable button and the Up/Down toggle, run the car.
4. Release the Enable button and note that machine and brake power are released and that the brake drops and holds the car.
5. Run the car and use the hand-held tach to verify inspection speed.

## Bypassing Faults on Inspection

Before installation and adjustment are complete, faults that will be adjusted out later may disrupt operation. To bypass faults on Inspection mode:

1. On the MPU board, place switch F3 in the UP position (all others down).
2. On the HC-CTL board, use a jumper to short the pins of JP1 Fault Bypass.
3. Press N until the display shows Controller System Menu.
4. Press S to enter the menu.
5. Press N until the LCD displays Inspection Mode Fault Bypass OFF.
6. Press S to change bypass state to ON.
7. Set F3 back to the DOWN position.

This setting bypasses controller response to faults during Inspection operation. When bypass is no longer necessary, be certain to change this setting to OFF.

2

## Finishing Installation

With the car running safely on Inspection operation, you are ready to finish installation. This section describes installing:

- Landing/positioning system
- Door operator
- Car operating panel
- Fire service peripherals
- Hall Calls

You must also:

- Balance the car and counterweight
- Adjust brake to hold 125% of full load

## Landing/Positioning System

The encoded tape used for the landing system is suspended between two mounting brackets that attach to the car rail using forged clips and hardware. If the job uses 8#, 23#, or 30# rail, you will need an additional kit for the proper size hardware: LS-ELGO-RAIL-08#, LS-ELGO-RAIL-23#, or LS-ELGO-RAIL-30#. **The high speed Elgo positioning system sensor and tape described here are not compatible with earlier versions.** Contact MCE if you have questions.

This information is specific to Elgo-240 standard and NEMA 4X landing systems. To be certain you are following the correct instructions:

- Described here:
  - Sensor Head about 19 inches (483mm) long
  - Head label starts with LIMAX2 followed by additional characters
  - Tape labeled AB20-80-10-1-R-X-15 and has arrows and UP label
- NEMA 4X systems are specifically labeled “NEMA TYPE 4X”
  - NEMA 4X systems use stainless steel hangers and hardware for corrosion resistance and a NEMA 4X rated tape switch.



Caution

**Improper installation could result in failure of the tape, mounting hardware, and reader. Please read instructions before installing!**

The Motion high speed positioning system uses a permanently encoded tape running the length of the hoistway. The tape is about 1/2-inch wide and consists of two bands; a metal band for strength and a dark, magnetic material band that carries the actual encoding.

- The encoded side of the tape (dark side) must face the elevator car.

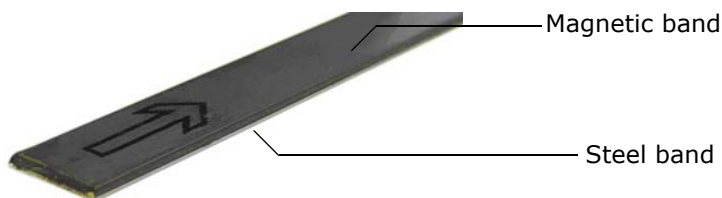

Caution

**The arrows on the magnetic side of the tape must point in the up direction and face the car.**

### Safety String Connection Information

The switch on the bottom tape mount must be connected in the hoistway safety string as shown in your job drawings. If the switch is not shown in your drawings, connect it as shown below.

Figure 2.15 Tape Switch Connection

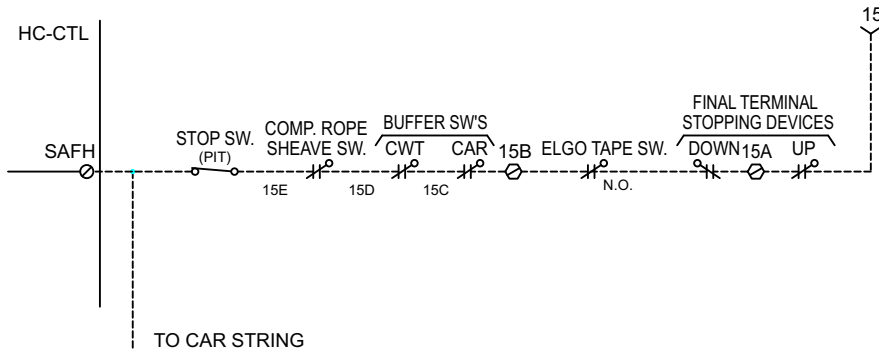

2

### Recommendations

If you install the bottom hanger and safety switch before hanging the tape, go ahead and test the switch function. When opened, the switch should shut off power to the machine and the brake causing the elevator to immediately stop.

After testing switch functionality, use a piece of wire or string to temporarily hold the switch in the closed position so that you can run the car on car top inspection to hang the tape.



**Caution**

Do not temporarily jumper the switch. It is far too easy to forget and leave the jumper in place.

## Installation

This kit is configured to mount the sensor head on the left side of the rail (as you face the rail blade). If necessary, you can change this to right side mounting. [Please refer to “Left to Right Rail Side Reversal” on page 2-68.](#) Tape hangers are steel channels that clamp across the back of the car rail using forged rail clips. The tape hangs directly from the top hanger and connects through a tensioning spring to a switch pivot on the bottom hanger. With the tape properly hung, spring tension keeps the pivot held against the switch, keeping it closed. If tension is lost due to a tape failure, the switch will open the safety string and bring the car to a stop.

1. Attach top and bottom hangers to the rail lightly using clips and hardware provided.
2. Use a tape measure to adjust the hangers to provide equal offset from rail edge to encoding tape. Tighten the retaining hardware.

**Figure 2.16** Tape Hanging Hardware

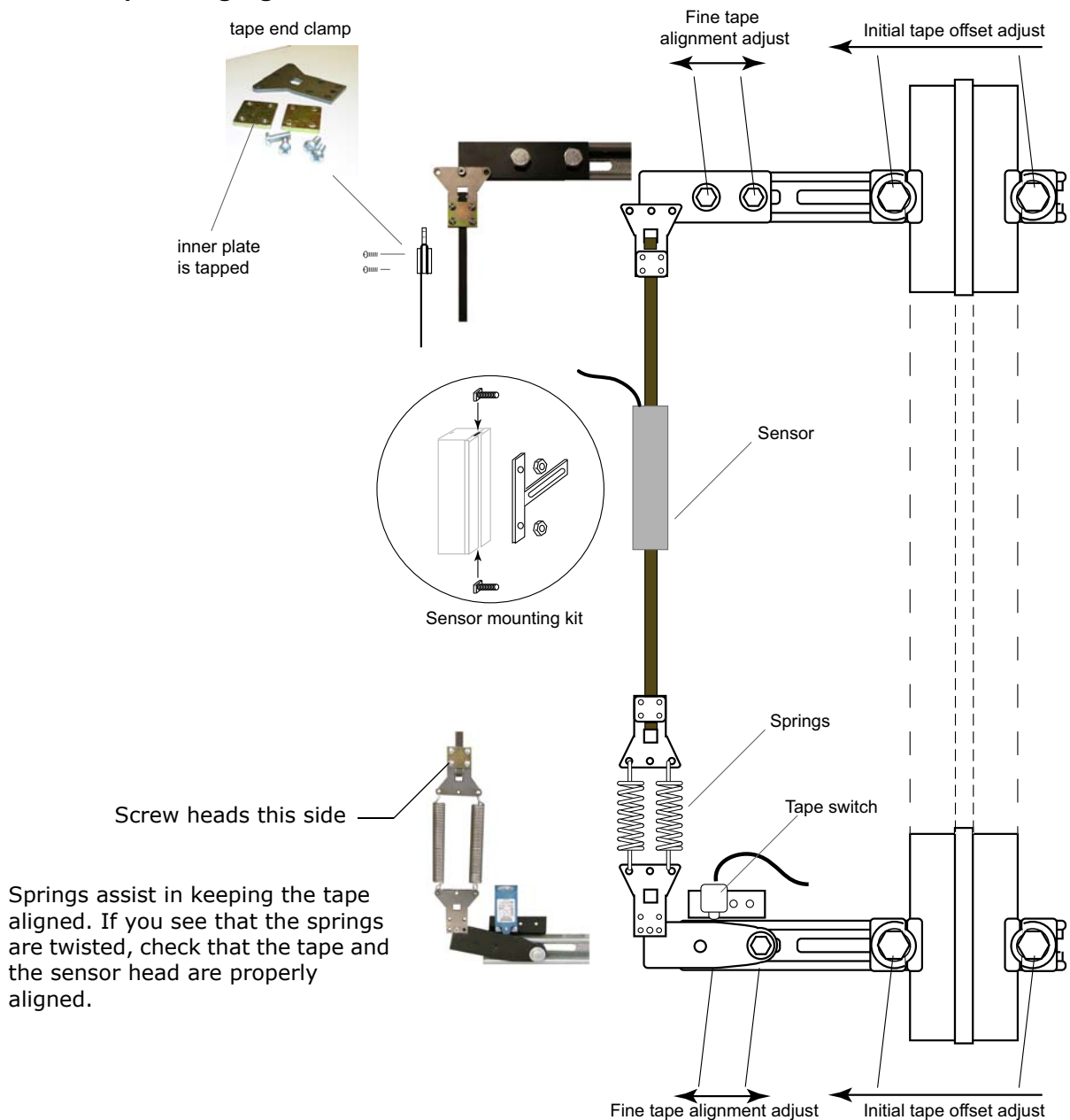



### Tape End Pieces

Tape end clamps are loosely assembled using 1-inch, 8x32 screws so that you can simply loosen them up, weave the tape through, and tighten the screws down. It may be easiest to attach just the top end piece now and then attach the bottom end piece after hanging the tape.

1. Loosen the screws on a tape end clamp. Slide the tape through between the center piece and the top clamp, magnetic band up, down through the square hole and back through between the center piece and the bottom clamp. See the figure below.

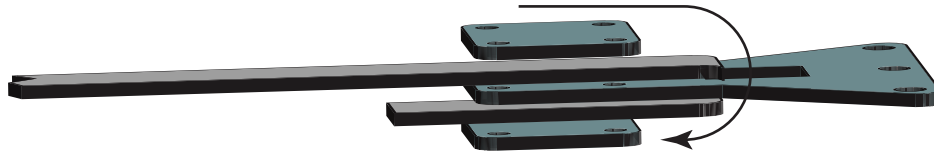

2. Gently tighten the screws in the order shown below. Square up the end clamp and the tape.

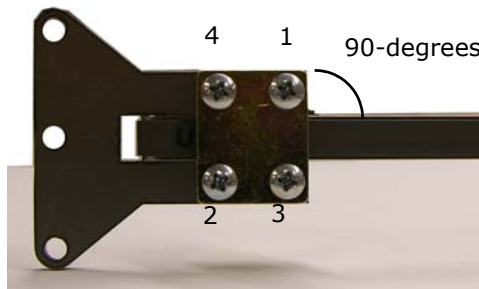

Side View

3. In the same 1, 2, 3, 4 order, make several passes, tightening each screw just a little each time. Finally, torque each screw to 14 in-lb. or 224 in-oz. (depending on the units on your torque driver).

2

## Hanging Tape

With the hangers in position on the rails such that the tape will hang approximately vertically, connect the tape to the top hanger using the hex bolt and locking nut provided. Make certain the arrow on the tape is pointing up and that the magnetic surface is facing the car. Begin unreeling tape toward the bottom of the hoistway:

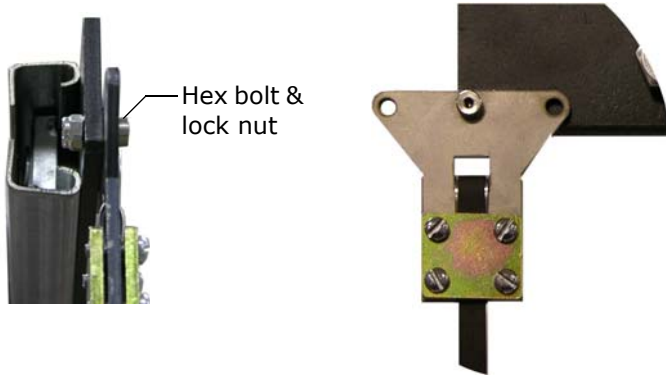

1. Move slowly down the hoistway and unroll the tape from the carrier.
2. Attach the bottom end of the tape using the hanger parts kits and the tensioning springs. Fine tune proper vertical alignment (both front-to-back and side-to-side) — the hanger bracket ends are adjustable to provide fine side-to-side alignment (step 3). At proper tension (about 16 lbf.), the springs will be stretched about 3.0" (75 mm) beyond their relaxed length.
3. The assemblies to which the tape attaches, both top and bottom, allow fine alignment adjustment without having to work with the heavy, rail clamp hardware. After adjustment, torque the 3/8 bolts/nuts to 10 ft lbs.

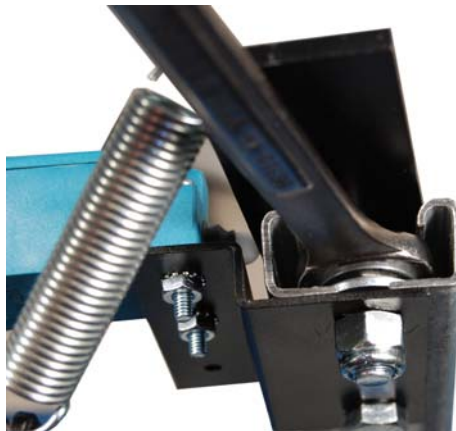

### Note

Check that the elevator car does not rock excessively. If necessary, adjust roller or other guides until excessive rocking is eliminated. The Elgo reader will track with the car. Excessive lateral car movement will translate into reader/tape alignment movement.

### Sensor Mounting

1. Move the car to the middle of the hoistway. Attach the sensor to the car. The head must be positioned such that the CAN cable exits the top of the sensor head.

Exactly how you mount the sensor head will depend on the physical structure of the car and sling and the position of the tape. Because there is so much variation between jobs, sensor head mounting brackets are usually fabricated on site. Three examples follow.



2

Note

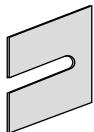

**Shims.** For the hangers described in this instruction, four shims are provided. Once you have completed sensor installation, if you find you are very slightly out of plumb, you may slightly loosen a bolt or nut and insert a shim to correct. If a component is out more than may be corrected by two or three shims, check major components, level, and plumb and correct the basic installation.

Figure 2.17 Sample Mount A (available option from MCE)

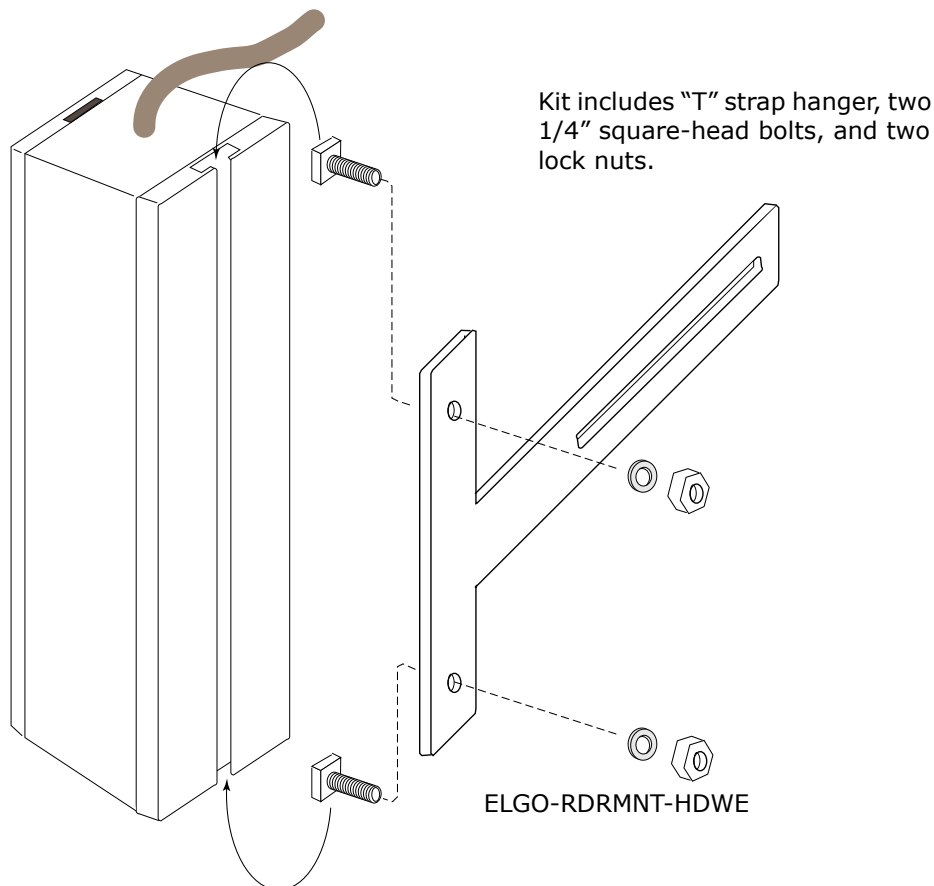

**Figure 2.18 Sample Mount B**

Slotted mounting holes on bracket allow adjustment.

The heads of the sensor mounting bolts are captive in a slot on the sensor body.

Bolts are 1/4" diameter with square heads. Use a flat washer against the mounting bracket, and a lock washer between the nut and the flat washer. M6, hex head bolts may also be used.

Use spacers to adjust the vertical alignment of the sensor head.

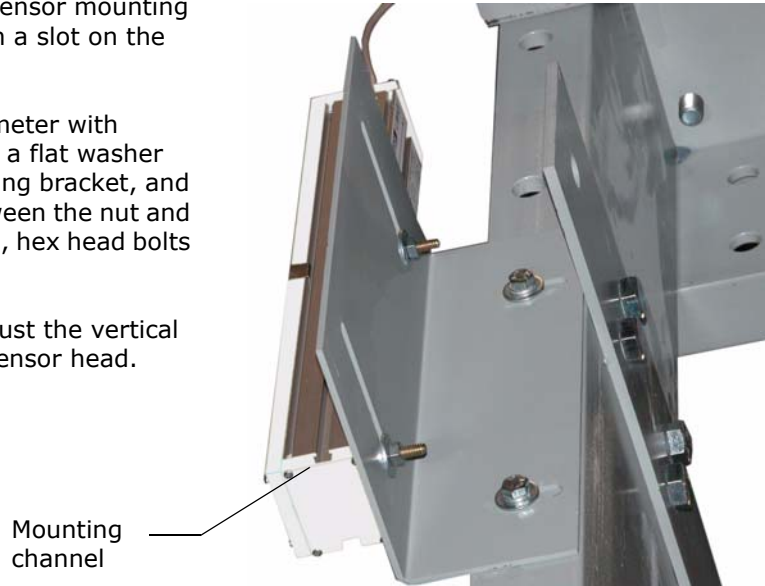

Alternatively, you can use 8 x 32 channel nuts and screws or 1/4" square head bolts and nuts. However, if you are inserting the screws toward the body of the sensor, you must be very careful that you position spacers to prevent the screw from damaging the sensor.

**Figure 2.19 Sample Mount C**

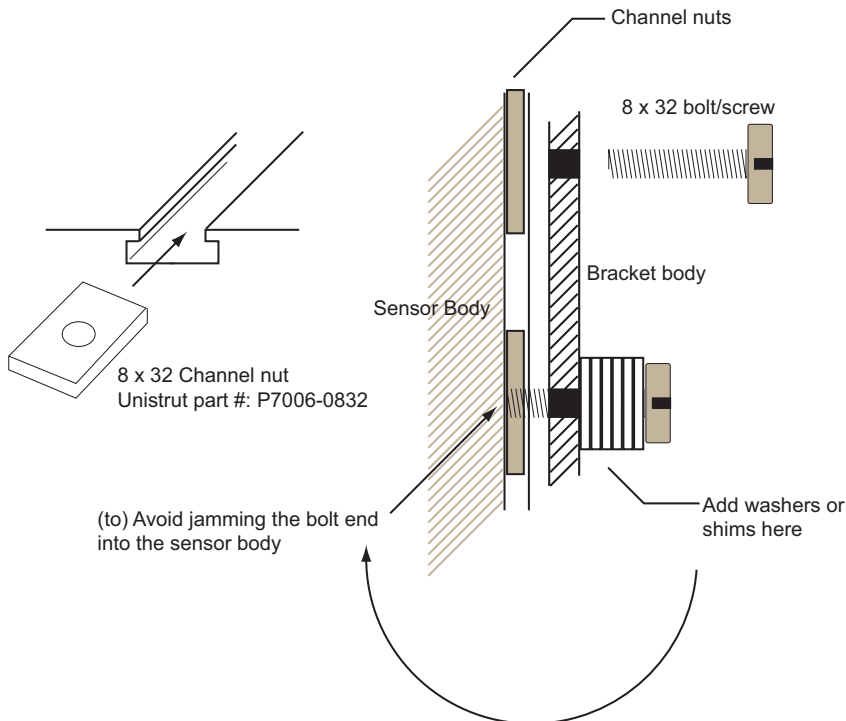

**Tape Must Be Plumb and Under Tension Before Completing the Following Steps**

1. Adjust the sensor to tape centerline alignment using the plumb tape as a reference as shown below.

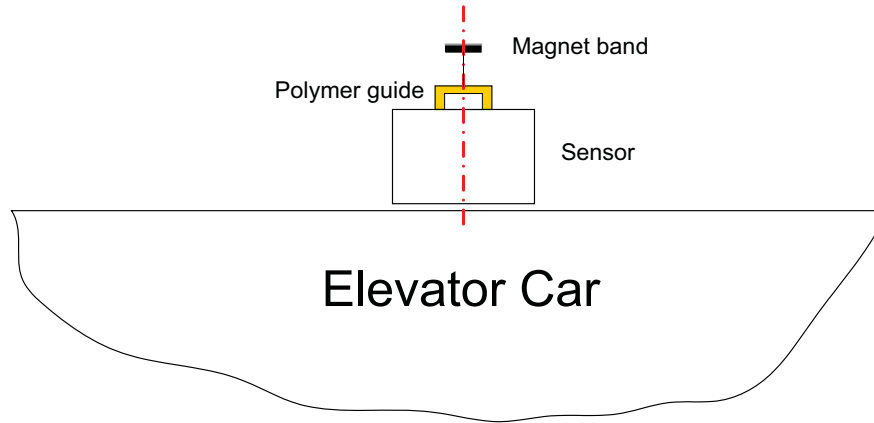

2

2. Remove the front polymer guide from the sensor by flexing it slightly out at the center and pulling it from the retaining clips at each end. Leave the sheet-plastic membrane in position on the sensor.

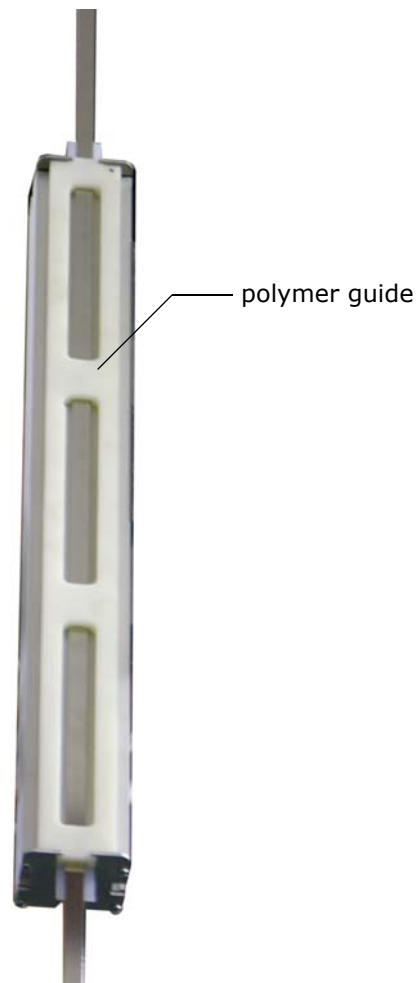

3. Adjust the distance between sensor and tape. Up to a travel height of 110 meters, we recommend an offset of 1 inch (25 mm) with the polymer guide removed. (See the illustration below.) Verify that the offset measures 1.0 inches at both the top and the bottom of the sensor. This will ensure steady, even contact between the steel side of the tape and the polymer guide of the sensor.

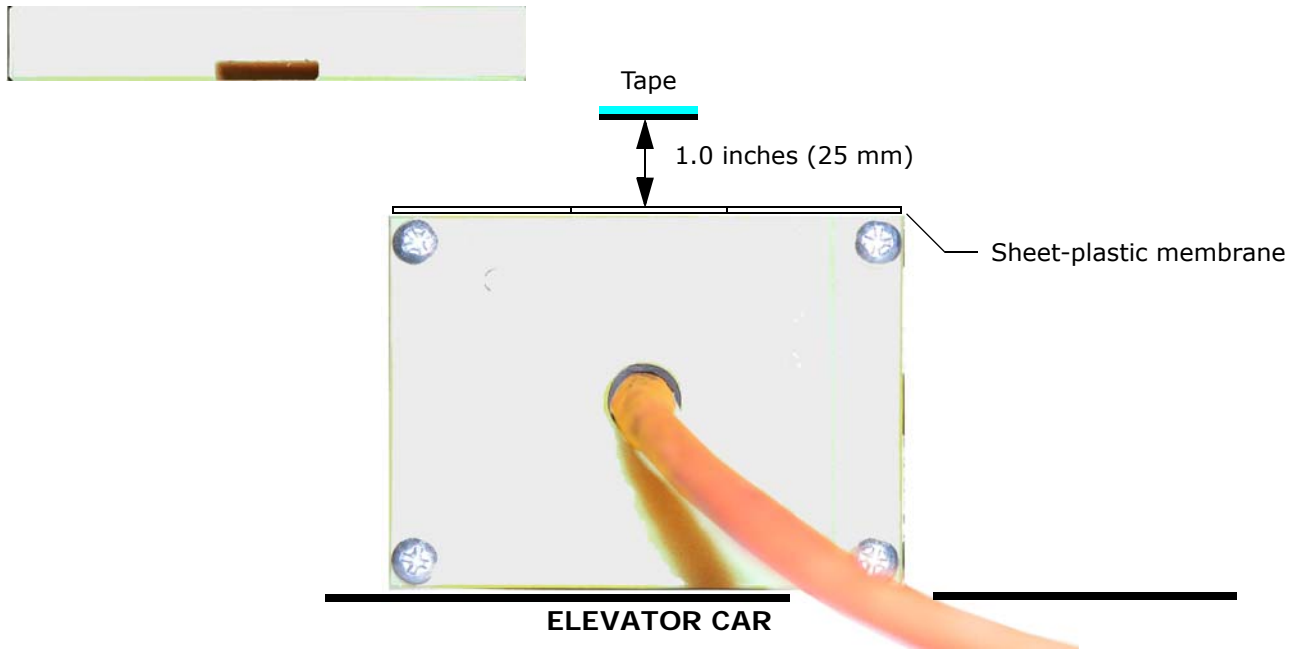

4. Re-attach the polymer guide with the tape resting in the guide slot.

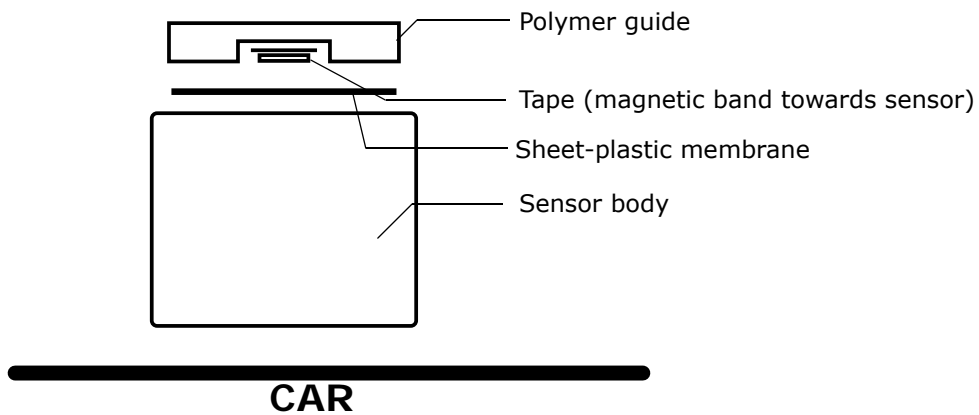



**Caution**

It is critical to ensure that the sensor is installed so that any mechanical contact between tape and sensor head is between the steel band and the polymer sensor guide. Adjust for a horizontal offset of 1 inch (25 mm) between the sensor metal face and the magnetic band so that contact between the steel side and the polymer guide is firmly forced.

When properly installed, looking at the top of the sensor, there will be a slight gap between the magnetic band and the body of the sensor. Refer to the illustration below.

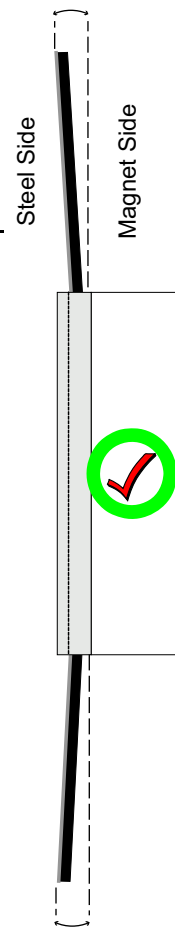

With the sensor guide re-installed, the tape should arc gently away from the car at the top and bottom, forcing the steel side of the tape firmly against the polymer guide.

Be certain that the sensor head is plumb with the tape. Check top and bottom to be certain it is not out at the bottom while appearing correctly offset at the top.

A rocking car with roller guide or isolation mount problems can exhibit sensor head alignment issues at different points in the hoistway.

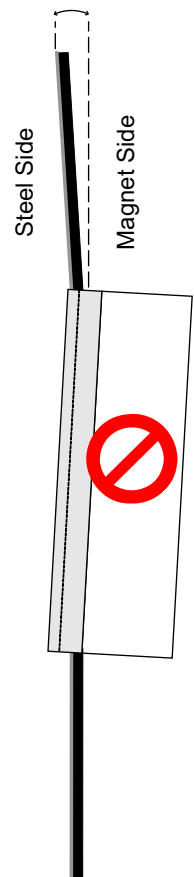

Verify that the tape is longitudinally aligned with the sensor face.

5. Check proper alignment of tape vs. sensor. Correct any angular offset.

**Figure 2.20 Positioning Tape Longitudinal Alignment**

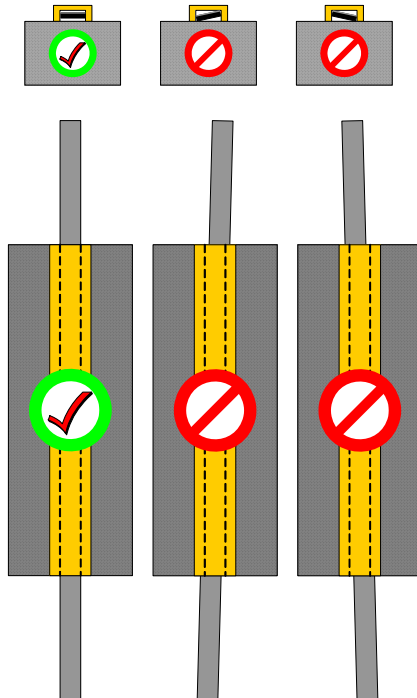

6. On cartop inspection, move the car to several points in the hoistway. Verify that tape-to-sensor alignment remains satisfactory in each position.
7. After completing installation, clean the tape. Beginning at the top of the hoistway, move down the full travel distance pulling the tape through a soft, dry cloth. Repeat this process before putting the elevator into service after completing installation



Caution

### Periodic Maintenance Required

Inspect and clean the sensor and encoded tape as part of your car top routine or at minimum intervals of 6 months for contract speeds below 400 FPM or 4 months for contract speeds above 400 FPM.

1. Check that the sensor is properly aligned and that the tape is running through the reader slot with the polymer guide pressing firmly against the steel backing and with no contact on the magnetic material, as described in this instruction.
2. Check for abnormal wear on both the tape and the guide.
3. Open the sensor head and check for debris in the guide-way.
4. Check that the bottom spring attachment provides adequate tape tension (spring stretched about 2" (50 mm) beyond its relaxed length, about 16 lbf.).
5. Clean the tape as in step 7 above.



## Configuration

A new landing system parameter has been added to the F7 parameters on the Motion 4000 controller HC-MPU board to accommodate newly available positioning systems.

- LANDING SYSTEM:
  - ELGO-160: Standard ELGO system.
  - ELGO-240: Elgo system documented in this instruction.
  - LS-EDGE: Magnet/vane system.

2

**Note**

The 160 and 240 designations refer to the distance between the individual sensors in the Elgo sensor head. One is 160mm; the other is 240mm.

## Left to Right Rail Side Reversal

As shipped, the kit is configured to mount the sensor head on the left side of the rail (as you are facing the rail blade). The kit can be reconfigured for right side mounting as described here. The illustration shows the components as if you were looking “through” the bottom of the bracket.

**Figure 2.21 Side Reversal, Bottom Mount**

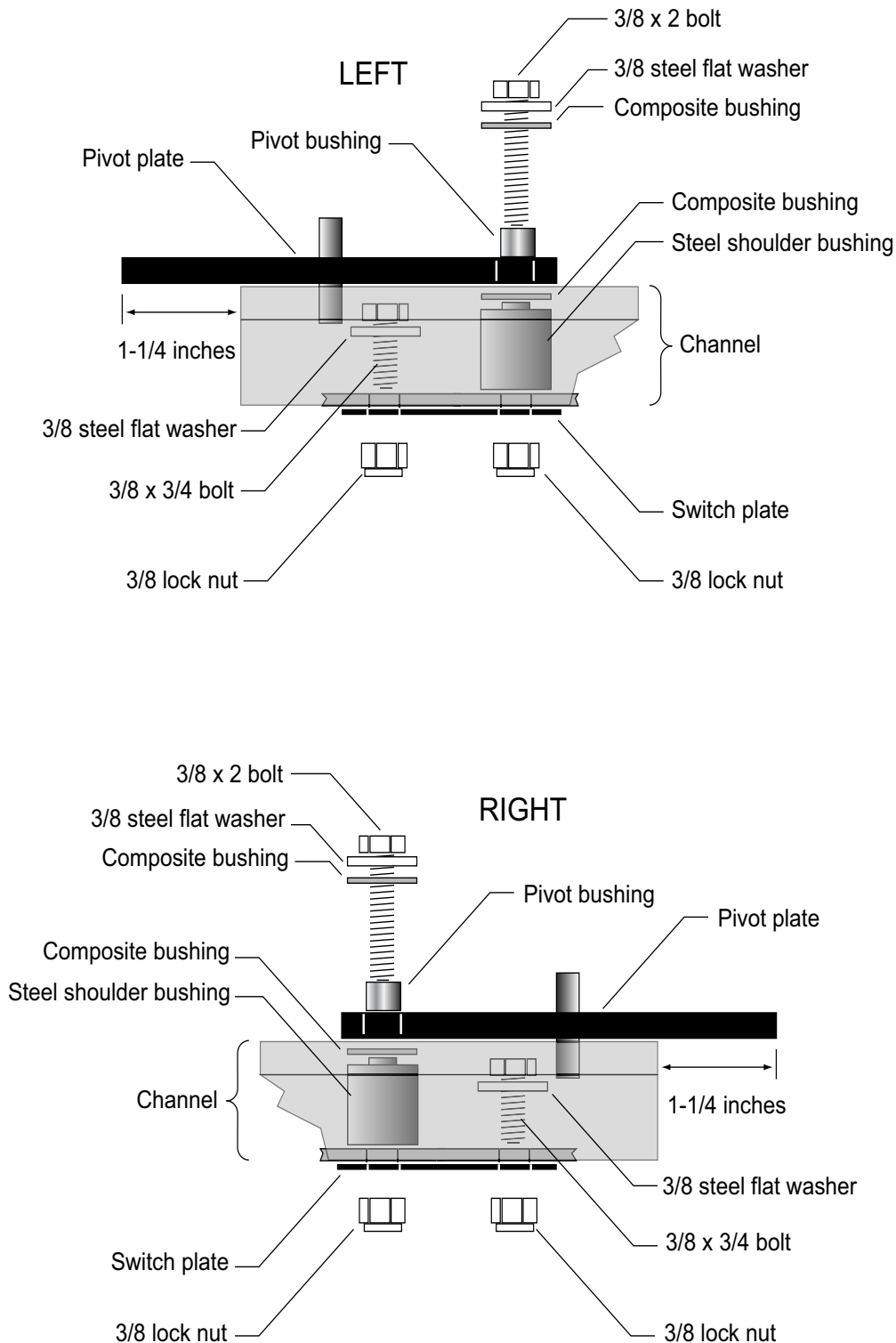

1. Place the mounting arm assembly on a working surface so that the pivot/switch assembly is on your right but upside down. (The pivot/switch assembly must always be located on the end of the angle bracket with the open-ended slot so that it has enough adjustment.
2. On the back of the mounting arm, remove the two lock nuts that secure the pivot/switch assembly in place.
3. Remove the components. Flip the switch plate and switch so that they are now on the top of the mounting arm.
4. Refer to the preceding illustration for reassembly order. Check that the pivot extends about 1—1/4" beyond the end of the mounting arm.
5. With the unit reassembled, torque the 3/8" bolts/nuts to 10 ft-lbs.
6. Remove the #8 Phillips screws, star washers, and nuts that hold the switch in position.
7. Move the switch to the outer mounting position. The switch must be properly aligned and the mounting screws torqued to 15 to 17 in-lbs.

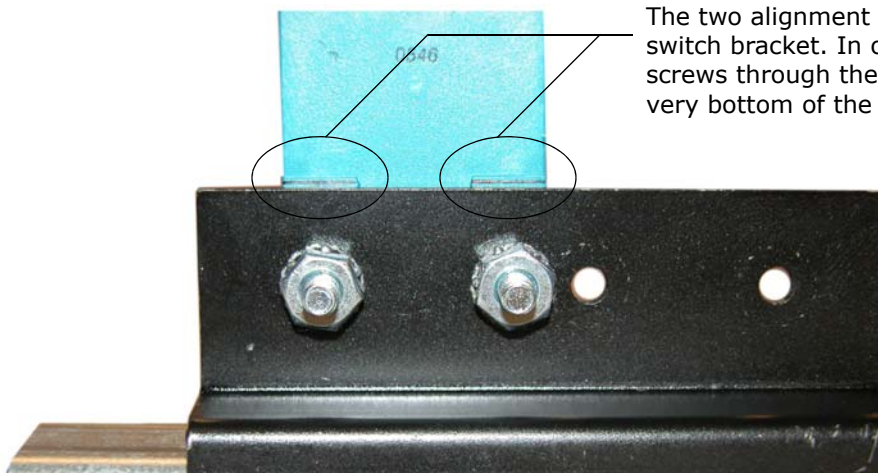
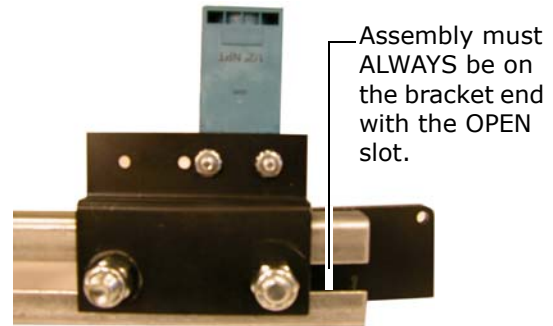

The two alignment tabs must rest on the top lip of the switch bracket. In order to do this, the two mounting screws through the front of the switch must be at the very bottom of the oblong screw holes.

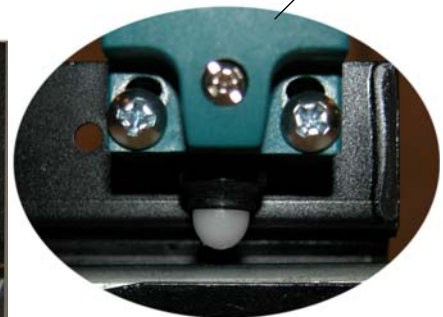

8. Once the switch is in position, rotate the pivot until it closes the switch. With your free hand, press the switch and note that it still has about 1 mm (1/25 in) of travel. This ensures that the pin on the pivot is contacting the inside of the mounting arm and protecting the switch from being damaged by excessive force.
9. Verify that the pivot moves smoothly and will drop when released.
10. When making electrical connections to the switch, note the torque settings for the connection screws and the switch cover screw.
  - Cover screw: 15 in-lbs
  - Normally Open connection screws: 15 in-lbs

To change the top mounting arm from left to right side:

1. Set the hanger arm assembly on a working surface so that the hanger plate is on your right.
2. Remove the two 1/2" bolts that secure the top hanger plate.
3. Flip the plate top-to-bottom so that the tape attachment hole is on the bottom.
4. Reassemble with the hanger plate extending beyond the end of the bracket by about 1 and 1/4 inches.
5. Torque the 1/2" bolts to 20 ft-lbs.

**Figure 2.22 Changing the Top Mounting Arm from Left to Right Side**

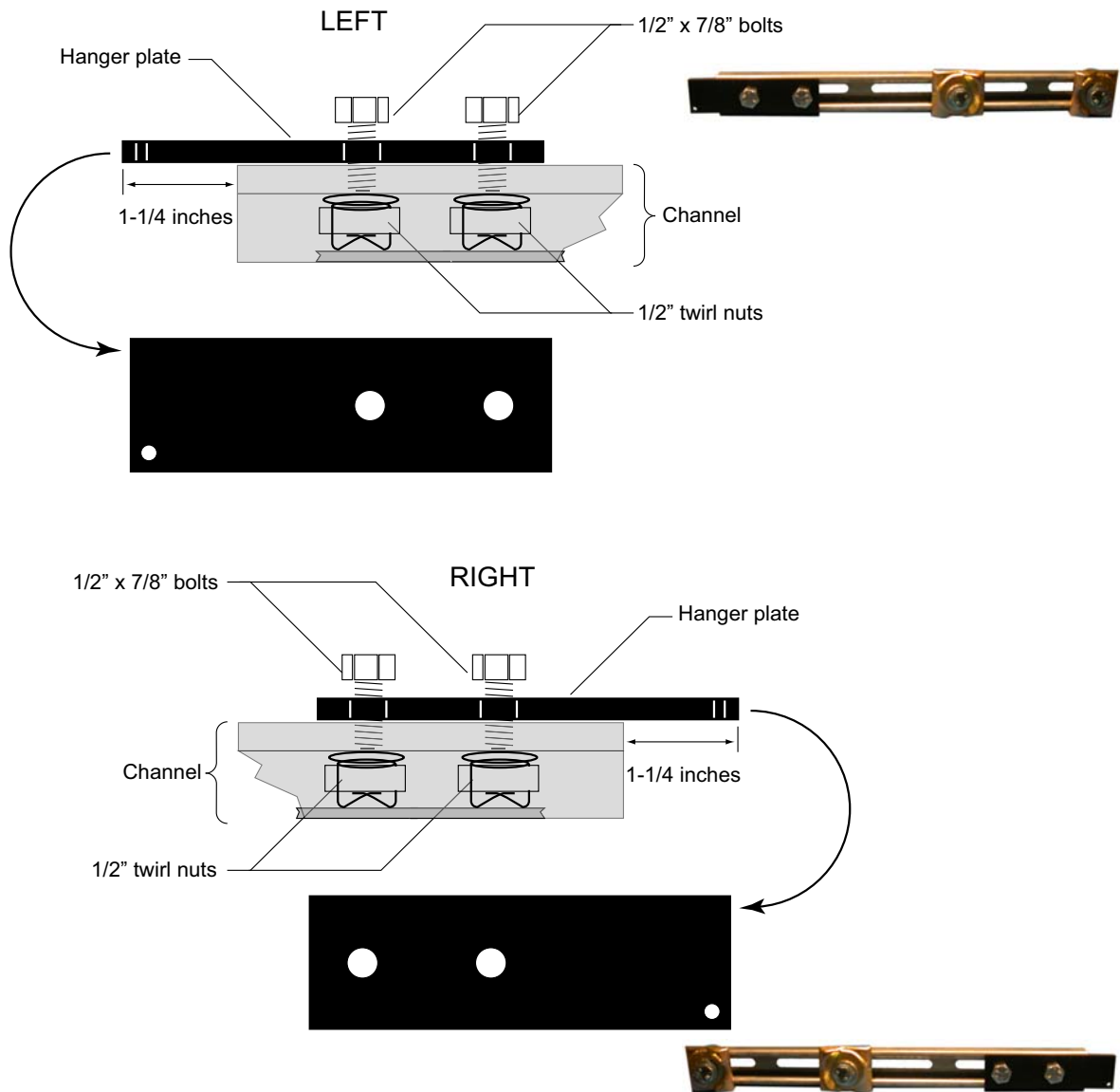

## Door Operator and Door Peripherals

Check the job prints to see that the door operator you are installing is the operator shown in your job prints.

- Install the operator according to manufacturer instructions.
- Make door operator electrical connections as shown in the MCE job prints.
- Verify that all door related switches and locks are properly installed, adjusted, and wired.

### Door Safety Equipment

- Install photo eyes and/or safety edges in accordance with manufacturer instructions.
- Make connections to MCE control as shown in the job prints.

### Door Switches

1. Install top, middle, and bottom door locks in accordance with drawings package.
2. Install gate switch and all car door position and limit switches.

## Car Operating Panels, Position Indicators, and Peripherals

- Install operating panels according to manufacturer instructions.
- If the job uses the Motion 4000 serial control panel option, install Control Panel Interface board(s) from MCE. [Please refer to “MC-CPI Car Panel Interface Board” on page 5-61.](#)
- Make electrical connections as shown in the MCE job prints for all panel buttons and indicators, position indicators, and controller-connected peripherals (fan/light timer, etc.).



#### Note

Note that the MCE circuit boards, serial or Universal I/O, communicate with the controller through and are powered through their CAN Bus connections.

## Fire Service Peripherals

1. Refer to the MCE job prints.
2. Make electrical connections to fire service switches, sensors, indicators, and buzzers as shown.



#### Note

After the car is adjusted and running on Automatic operation, fire recall, fire operation, and proper fire or smoke sensors and indicators will be exercised for correct operation.

## Duplex Connection Between Controllers

If you are installing controllers in a duplex configuration, you must connect a communication cable between the two as shown in your job prints. Jumper JP3 (terminates the CAN bus) must be in place on each HC-MPU board. The controls must also be set up in software to operate as a duplex installation (F1, Program Mode).

Figure 2.23 Typical Duplex Communication Connection

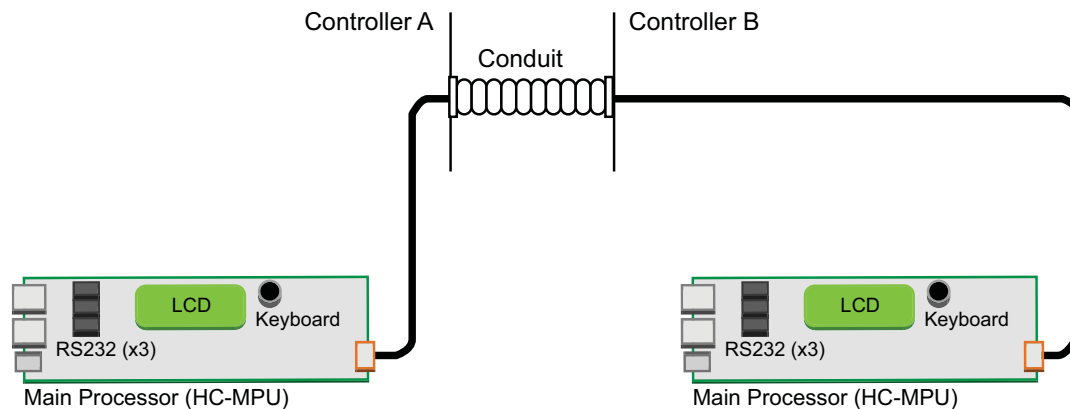

## Hall Calls, Position Indicators, and Peripherals

Motion 4000 hall calls may use discrete call connections or optional CAN Bus connections.

Please refer to “Hall Call Node Wiring” on page 5-68 if you have serial hall calls.

1. Install hall calls, position indicators, and peripherals (auxiliary risers, etc.) according to building requirements and pertinent local and national codes.
2. Install access switches in hall ways in accordance with drawings package.
3. Connect hall switches, push buttons, and indicator lamps or LEDs as shown in the MCE job prints.

### CE Position Indicators

CE Electronics position indicators are supported using a CE driver board in the controller. The driver board connects to the controller internal CAN bus. A transformer provides 24-volt power to the board. The three-wire CE output (1= common, 2= fixture power, 3= data) is typically brought to panel mount terminals (RD1, RD2, RD3) for easy access. Refer to the MCE drawings package and to the CE documentation provided with your fixtures.

## Adjust Brake to 125% of Full Load

1. Bring the car to the bottom landing.
2. Place weights in the car to 2/3 of contract load.
3. Add an additional 50 or 100 pounds.
4. Move the car up a short distance on Inspection.
5. Run the car down and trip the stop switch.
6. Adjust the brake if it does not hold.
7. Repeat until the brake is holding 125% of full load capacity.
8. Remove test weights from car.

2



### Caution

Keep the car near the bottom floor as it is likely to slide through the brake onto the buffers if brake spring tension is inadequate.

## Traction Auxiliary Power Supply

If you are installing the TAPS (Traction Auxiliary Power Supply) from MCE to provide emergency power for passenger rescue in the event of commercial power loss, follow instructions in the TAPS manual delivered with the unit.

If TAPS is used with the TorqMax/KEB F5 drive, drive parameter LF.61, Emergency Operation Mode, must be set to di1. If not, the motor is not correctly powered during TAPS operation.

### Installation Review

- Carefully review MCE job prints and job requirements.
- Ensure that all equipment has been correctly installed and connected.
- Verify that all jumpers placed during installation have been removed and replaced with permanent connections.
- Verify that all safety equipment is installed and is functioning properly.
- Ensure that Inspection faults are no longer on bypass in the Controller System Menu (F3 function switch on MPU board)

At this point, controller and related installation should be complete. The car should be running safely on Inspection operation from the cartop and/or the machine room. The next section will describe:

- Learning the hoistway
- Setting controller parameters
- Setting drive parameters
- Performance Adjustment
- Final Test





**Motion Control Engineering®**

A Kinetek Company®

*Final Adjustments*

---

## In this Section

This section contains instructions for preparing the car for normal automatic operation. If you are viewing this on a computer, click the blue text to jump to the appropriate section.

- Setting basic service parameters. [Basic Service Parameters on page 3-2.](#)
- Learning floor levels. [Learning Floor Levels & Counterweight Position on page 3-2.](#)
- Balance Car and Counterweight. [Car and Counterweight Balance on page 3-6](#)
- Setting motion/position parameters. [Setting Motion/Position Parameters on page 3-7.](#)
- Setting Up Performance Curves. [Setting Up Performance Curves on page 3-10.](#)
- Learning hoistway switches. [Measuring NTS and ETS Switch Locations on page 3-15.](#)
- Coming up to contract speed. [Additional Adjustment on page 3-19.](#)
- How to place car calls from the controller. [Placing Calls From the Controller on page 3-22.](#)
- Load testing AC drives. [Load Testing AC Drives on page 3-23.](#)
- Load Weigher Adjustment. [Load Weigher on page 3-25.](#)
- Acceptance Testing. [Final Tests on page 3-35.](#)
- Final Adjustment. [Final Adjustment on page 3-56.](#)

## Basic Service Parameters

Parameters accessed through the F1 (Program Mode) function on the HC-MPU board define the building, floors and openings to be serviced, and other basic requirements for the elevator. Before the controller is shipped, these basic service definitions are set according to the survey forms for the job. However, you must verify Basic Features Menu settings are correct for the job before proceeding.

Please refer to “Basic Features Menu” on page 4-13 for basic service setup.

## Learning Floor Levels & Counterweight Position

The following table is provided so that you can enter floor heights and offsets for your records.

Table 3.1 Floor Height and Offset Notation

Floor	Height	Offset	Floor	Height	Offset
1			17		
2			18		
3			19		
4			20		
5			21		
6			22		
7			23		
8			24		
9			25		
10			26		
11			27		
12			28		
13			29		
14			30		
15			31		
16			32		

The F6 menu provides a process to learn the floor levels and counterweight position for the building. The process is different depending on the type of landing/positioning system for the job.

## ELGO Encoded Magnetic Tape

1. Place the car on Inspection mode.
2. Verify the floors and openings through the F1 (Program Mode) menu if you have not already done so. (F1: [Program Mode on page 4-11.](#))
3. Plug the hand-held user interface into a CAN connection in the car panel or on the car-top. Otherwise, use the HC-MPU board keypad/LCD in the controller. (If the controller keypad is used, a technician must be stationed in the car to relay information to the technician in the machine room.)
4. Move the car to level at the first floor.

5. Select the F6 menu on the hand-held or HC-MPU board (F6 switch UP, all others down).

- **ELGO LEARN. PRESS NEXT TO LEARN OR SELECT TO FILL**

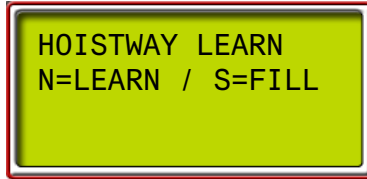

3

**Learn** Selecting LEARN starts a process in which you move the car up the hoistway a floor at a time, leveling and saving at each floor.

1. Press N. The display will prompt: Go to landing 1.
  2. Bring the car as close to level at landing 1 as is practical. Press S.
  3. The display will ask you to enter an offset to make up for any difference in level between car and floor: xxx.x In. Adj + - Next when done.
  4. Measure the offset (if any).
  5. If the car is above the floor, use the + (plus) button to enter the offset value. If the car is below the floor, use the - (minus) button to enter the offset value.
  6. Press N. The display will prompt you to move to the next landing. The process will repeat at each landing until all have been learned.
  7. When all floors have been learned, the display will prompt you to learn counterweight position.
- **MOVE CAR ADJACENT TO COUNTERWEIGHT, THEN PRESS NEXT.**
8. Move the car until car and counterweight are level with one another in the hoistway.
  9. Press N. The display will prompt you to store values:
- **HOISTWAY LEARNED. S=STORE.**
10. Press S. The display will prompt:
- **HOISTWAY STORED**
11. Exit F6 menu on the hand-held or place F6 switch down on the HC-MPU board.

**Fill** Selecting FILL allows you to enter a common height for all floors which will then be filled in by system software. The position of the counterweight is automatically set to one half the cumulative height of the floors.

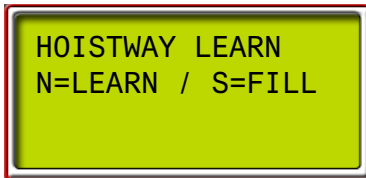

1. With the car level at floor one, Press S.
2. Use the “+”/”-” buttons to enter a common floor height in inches.

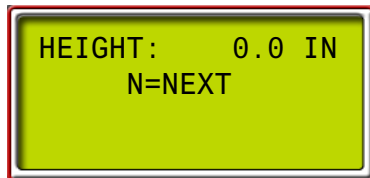

3. Press N. The display will prompt you to store values:
  - **HOISTWAY LEARNED. S=STORE.**
4. Press S. The display will prompt:
  - **HOISTWAY STORED**
5. Exit F6 menu on the hand-held or place F6 switch down on the HC-MPU board.

## LS-EDGE Steel Tape

1. Place the car on Inspection mode.
2. Verify the floors and openings through the F1 (Program Mode) menu if you have not already done so. ([F1: Program Mode on page 4-11.](#))
3. Select the F6 menu on the hand-held or HC-MPU board (F6 switch UP, all others down).

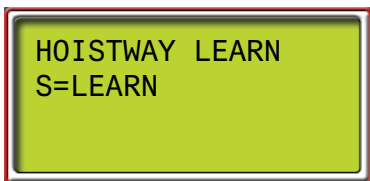

4. Press S to begin.
 

As you follow the instructions on the LCD, the car will first travel down to the bottom terminal at Correction speed and locate the center of the door zone magnet at that location. From the bottom terminal, the car will move up the hoistway finding each door zone and indicating the height in inches of each door zone magnet center. Upon reaching the top terminal, the LCD will display Learn Complete.

## Adjusting Floor Heights

Stored floor heights may be accessed through the F7 menu (first 64 parameters) and the height of each floor individually adjusted at any time. F7 parameter 67 allows you to adjust the counterweight height.

1. Enter the F7 menu (F7 up, all other switches down).
2. Press N to advance to the desired parameter.
3. Use “+” or “-” buttons to adjust the height of the floor (or counterweight).
4. Place F7 in the down position.

## Door Zone Verification

Following the hoistway learn process, starting at the top floor, move the car down on inspection and verify that the door zone indicators (e.g., LEDs, relays, diagnostic status, etc.) activate only at the appropriate locations at the landings (i.e., +/- 75 mm or 3”) and nowhere else. Be sure to check rear door zones as well, where applicable.

## Car and Counterweight Balance

Hoistway machine performance is specified to a particular load (car equipment and passengers) and to a specified offset to the load through counterweighting. On modernizations, the weight of the car is often changed but compensating adjustments to the counterweight are sometimes overlooked. This adjustment is important to performance and ride characteristics.

1. Place a balanced load in the car (specified percentage of full load; typically 40% but sometimes 45 or 50%).
2. On Machine Room Inspection, run the car to the middle of the hoistway to the position learned by performing the counterweight learn procedure.
3. Turn controller power OFF.
4. Use a portable supply to inject sufficient DC voltage at controller terminals B1 and B2 to lift the brake. (Or, manually lift the brake.)
5. Watch the car to see if it drifts. If not, the car and counterweight are balanced.
  - If the car drifts up, remove weight from the counterweight or add weight to the car and repeat the balancing procedure.
  - If the car drifts down, add weight to the counterweight or remove weight from the car and repeat the balancing procedure.
  - For a drum machine, follow the manufacturer counterweighting recommendations and test the drum machine limit switches.
6. When car and counterweight are balanced, record the actual weight in the car for future reference. Balanced load = \_\_\_\_\_ lbs.
7. Restore controller power.

## Setting Motion/Position Parameters

Floor heights, terminal switches, drive, and machine characteristics that influence speed and position computation must be set up through the F7 menu before attempting to bring the car up to contract speed. [Please refer to “F7: Parameters Adjust” on page 4-100](#) for setting instruction.

### Often Used Procedures

Following are some procedures and techniques that may be frequently used when adjusting the car:

#### How to check Car Speed:

1. Place Function Switch F3 on the HC-MPU board in the ON (up) position.
2. Press the N push button until CONTROLLER SYSTEM MENU is displayed.
3. Press the S push button to select the menu.
4. Press the N push button until POSTN and SPEED are displayed.
5. Run the car. Speed is displayed in feet per minute.

#### How to place the car on Inspection Mode Fault Bypass:

1. On the HC-MPU board, place Function Switch F3 in the ON (up) position.
2. On the HC-CTL board, use a jumper to short the pins of JP1 Fault Bypass.
3. Press the N push button until CONTROLLER SYSTEM MENU is displayed.
4. Press the S push button to select the menu.
5. Press the N push button until INSPECTION MODE FAULT BYPASS is scrolled on the display. (All faults, other than MPI-C Inspection Overspeed are bypassed.)
6. Press the S push button to change the setting to BYPASS ON. (Remains bypassed even through power cycle, until reset.)

#### How to place the car on Automatic Mode Fault Bypass:

1. On the HC-MPU board, place Function Switch F3 in the ON (up) position.
2. On the HC-CTL board, use a jumper to short the pins of JP1 Fault Bypass.
3. Press the N push button until CONTROLLER SYSTEM MENU is displayed.
4. Press the S push button to select the menu.
5. Press the N push button until AUTOMATIC MODE FAULT BYPASS is scrolled on the display. (All faults other than MPI-C Contract Overspeed are bypassed.)
6. Press the S push button to change the setting to BYPASS ON. (Times out automatically after two hours.)

## How to access/set the F7 parameters:

**Important** Once set at the factory, F7 parameters are protected by positioning a jumper on the HC-CTL board. Before you can access F7 parameters, you must be on Inspection mode and set the jumper appropriately:



1. On the HC-MPU board, place Function Switch F7 in the ON (up) position.
2. Press the N push button to begin. DOWNLOADING PARAMETERS FROM MPU is scrolled followed by parameter zero, ADJUST FLOOR 01F POSITION....
3. The parameters are numbered 0 through xxx. Press the N push button to advance to the next parameter. Press and hold the N push button to advance at high speed. Press the N plus minus (-) push buttons to move to the previous parameter.
4. Use the plus (+) and minus (-) push buttons to change the parameter setting.
5. When you have finished setting parameters, press the S push button to exit the menu. ADJUST COMPLETE, PRESS (S) TO STORE is scrolled on the display. Press the S push button to store your changes. STORING VALUES... is displayed followed by VALUES STORED.

## How to Reset Excessive Faults

Many of the faults generated while performing acceptance tests are self-resetting once the fault condition is corrected. However, this controller has excessive faults logic which will generate an EXCESSIVE FAULTS SHUTDOWN if more than the established limit of faults occur within the circumscribed period of time. To reset this fault:

- Press the Fault Reset button on the HC-CTL board.



### How to Register Calls from the Controller

To place a call from the controller (or the hand-held):

- Place the F5 function switch up (all others down).
- Press S until Front Call Registration is displayed.
- Refer to the illustration below.

3

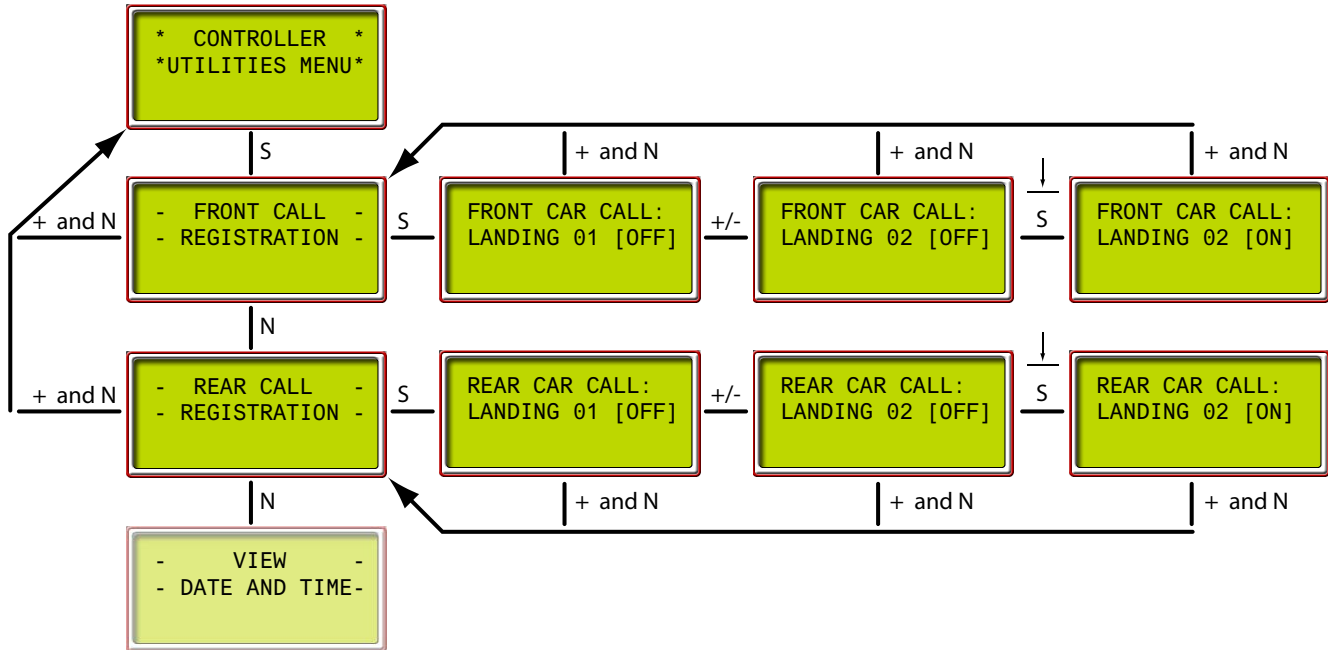

- +/- to increment or decrement floor numbers
- Press and momentarily hold S to register calls; displays [ON] while held
- Press + and N together to back out of the current display

## Setting Up Performance Curves

Before attempting to bring the car up to contract speed, you must have verified drive parameters as described in Section 2, [Torqmax F5 AC Drive Parameters on page 2-31](#) or [Magnetek AC Drive Parameters on page 2-36](#), F7 parameters as described in Section 4, [F7: Parameters Adjust on page 4-100](#), and be successfully running on Inspection mode with all equipment installed.

Performance curves are defined by acceleration and deceleration rates. The top speed attained using a curve is defined by speed settings for a particular mode of operation (Contract Speed, Inspection Speed, etc.). Multiple speed settings can use the same performance curve. [Please refer to “Controller F7 Menu” on page 3-11.](#)

## Acceleration and Deceleration Rates

Acceleration and deceleration rates are measured and programmed in  $\text{ft/s}^2$  (feet per second per second). Jerk parameters adjust the rate of transition from one speed to another and are measured and programmed in  $\text{ft/s}^3$  (feet per second per second per second). F7 control parameters correspond to curve locations as shown in the following figure. Increasing Jerk values causes faster change. While adjusting S-Curve parameters, stay away from terminal floors.

Figure 3.1 Motion 4000 Performance Curves

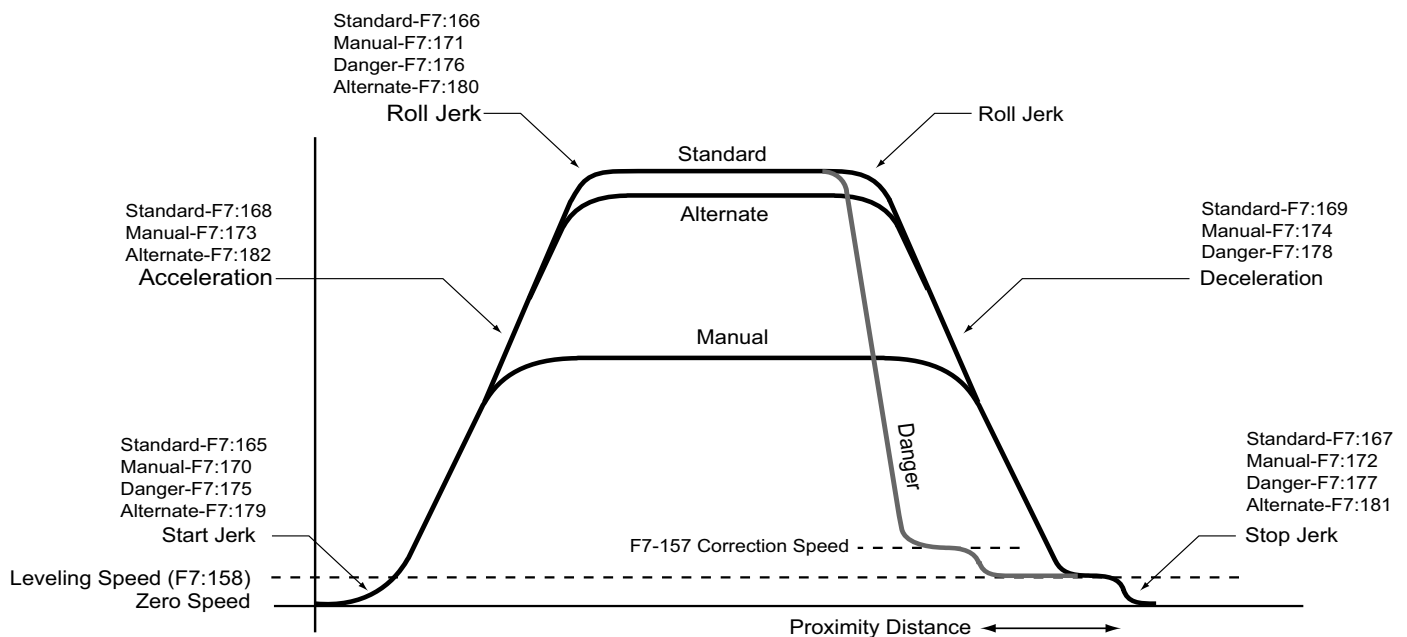

### Curves Used for Operating Speeds

The performance curves shown above and the operating speeds that use them are:

- Standard Curve: Contract, correction, earthquake, and leveling speed
- Alternate Curve: Conservation, and emergency power speed
- Manual Curve: Inspection and reduced inspection speed
- Danger “Curve”: Used for emergency deceleration

**Profile Parameters**

Typical initial values to begin adjusting toward contract speed running are listed in the table below. Hoistway speed and position related information may be reviewed using a controller F5 switch-accessed menu. [Please refer to “MPI Diagnostic Menu” on page 4-64.](#)

- **Start jerk** - defines rate of transition from zero speed to full acceleration. As Start Jerk increases, the profile transitions more quickly from starting to maximum acceleration.
- **Acceleration** - determines the maximum acceleration for the profile.
- **Roll jerk** - Roll Jerk determines the rate that the profile transitions from maximum to zero acceleration and zero to maximum deceleration. As Roll Jerk increases, the profile transitions more quickly. Lower values provide greater comfort but are harder to fit into the shortest one-floor-runs.
- **High speed** - determines the maximum speed for the Standard curve, usually the same as contract speed (ft/min).
- **Contract speed** - the rated speed for the car.
- **Inspection speed** - determines the speed at which the elevator will run when the Manual curve is being used.
- **Deceleration** - determines the maximum deceleration for this profile.
- **Stop jerk** - defines the transition from deceleration to Leveling Speed. As Stop Jerk increases, the profile transitions more quickly from Deceleration to Leveling Speed.
- **Leveling speed** - determines the Speed at which the elevator will level into the floor.

**Table 3.2 Controller F7 Menu**

Curve Aspect	F7 Parameter	Initial Setting	Unit
Start Jerk	165, 170, 175, and 179 (each per curve)	From 4.0 to 8.0 ft/s <sup>3</sup> (1.219 to 4.438 m/s <sup>3</sup> . Higher value results in a sharper start.	ft/s <sup>3</sup>
Acceleration	168, 173, and 182 (each per curve)	Maximum value is typically 4.0 ft/s <sup>2</sup> (1.219 m/s <sup>2</sup> ) and the minimum is usually not less than 2.5 ft/s <sup>2</sup> (0.762 m/s <sup>2</sup> ). Values higher than 4.0 ft/s <sup>2</sup> (1.219 m/s <sup>2</sup> ) are possible but do not yield significant improvements in performance.	ft/s <sup>2</sup>
Roll jerk	166, 171, 176, and 180 (each per curve)	Set by software.	ft/s <sup>3</sup>
Deceleration	169, 174, 178, and 183 (each per curve)	Maximum value is typically 4.0 ft/s <sup>2</sup> and the minimum is usually not less than 2.0 ft/s <sup>2</sup> with more common values ranging from 2.75 ft/s <sup>2</sup> to 3.75 ft/s <sup>2</sup> (0.838 to 1.143 m/s <sup>2</sup> ). The value of Deceleration is usually slightly less than the value of Acceleration (by 0.25 to 0.5)	ft/s <sup>2</sup>
Stop jerk	167, 172, 177, and 181 (each per curve)	From 4.0 to 8.0 ft/s <sup>3</sup> (1.219 to 4.438 m/s <sup>3</sup> . Higher value results in a sharper stop.	ft/s <sup>3</sup>
High speed	150	Set to Contract Speed.	ft/m
Inspection speed	155	As desired, up to 66% of contract speed or 125 ft/m	ft/m
Leveling speed	158	2 to 5% of contract speed, 0 - 8 FPM.	ft/m
Contract speed	149	Contract speed	ft/m
Profile Scale	141	Initially set to 50%. After making some adjusting runs, this can be gradually be increased to 100% to attain contract speed.	%

## Typical Speed Profile Settings

**Table 3.3 Speed Profile Settings Per Rated Speed**

Params	25 FPM or Less	(26-75) FPM	(76-100) FPM	(101- 199) FPM	(200- 249) FPM	(250- 349) FPM	350FPM or greater
Standard Jerk (165) Alt Start Jerk (179)	0.10	0.15	1.5	3.0	3.0	4.0	4.0
Standard Roll Jerk (166) Alt Roll Jerk (180)	0.10	0.15	1.5	3.0	3.0	4.0	4.0
Standard Stop Jerk (167) Alt Stop Jerk (181)	0.10	0.15	1.5	2.5	2.5	2.5	2.5
Standard Accel. (168) Alt Accel (182)	0.10	0.25	0.5	1.75	2.5	2.75	3.0
Standard Decel. (169) Alt Decel. (183)	0.10	0.25	0.5	1.25	1.5	1.75	2.0
Man Start Jerk (170)	0.10	0.15	0.50	1.00	1.00	1.00	1.00
Man Roll Jerk (171)	0.10	0.15	0.50	1.00	1.00	1.00	1.00
Man Stop Jerk (172)	0.10	0.15	0.50	1.00	1.00	1.00	1.00
Man Accel. (173)	0.10	0.25	0.50	0.50	0.50	0.50	0.50
Man Decel. (174)	0.10	0.25	0.50	0.50	0.50	0.50	0.50
Danger start Jerk (175)	5.0	10.0	Auto Calc	Auto Calc	Auto Calc	Auto Calc	Auto Calc
Danger Roll Jerk (176)	2.0	2.0	Auto Calc	Auto Calc	Auto Calc	Auto Calc	Auto Calc
Danger Stop Jerk (177)	1.0	2.0	Auto Calc	Auto Calc	Auto Calc	Auto Calc	Auto Calc
Danger Decel. (178)	0.25	0.75	Auto Calc	Auto Calc	Auto Calc	Auto Calc	Auto Calc
Standard Slew slope (142)	0.15	0.15	0.25	0.5	0.5	0.5	0.5

## Adjust for Drive Response

Depending on how the drive is tuned, the amount of lag between the commanded speed and drive response can vary. As a result, as the drive is adjusted, the Profile Advance parameter in the controller F7 menu will need to be changed as well. Use the information below along with the information in the figure, Velocity and Acceleration on page 3-14, and the tuning instructions following the figure to make these adjustments.

- If lag delay is insufficient, the elevator will plow into a landing. The acceleration and jerk rate during deceleration to a landing will be greater than profile values indicate.
- If lag delay is excessive, the elevator will drag into a landing. The acceleration and jerk rate during deceleration to a landing will be less than profile values indicate. In addition, a discontinuity in the profile will occur during the transition from acceleration to deceleration for movement between floors where a stabilized speed (contract speed) is not reached (short runs).
  - To adjust lag delay, observe the commanded speed on the TC-MPI board at the AN1 analog output. Perform one-floor-run movement and observe the peak acceleration transitioning to peak deceleration as the elevator reaches its peak speed (below contract speed). This transition should have no vertical discontinuity (too much lag delay). This transition adjustment is only valid when the elevator is unable to reach contract speed for the profile under normal operation. Adjust lag delay until the vertical discontinuity is eliminated.
- KEB/TorqMAX: Generally, the Profile Advance (F7, 140) will be within 50 to 150 milliseconds.
- Magnetek: Generally, the Profile Advance (F7, 140) will be within the following range (in milliseconds):

$$\frac{1000}{*\text{Response}} \leq \text{Profile Advance} \leq \frac{2000}{*\text{Response}}$$

\* Response value is located in the Magnetek HPV A1 Drive Menu.

Figure 3.2 Velocity and Acceleration

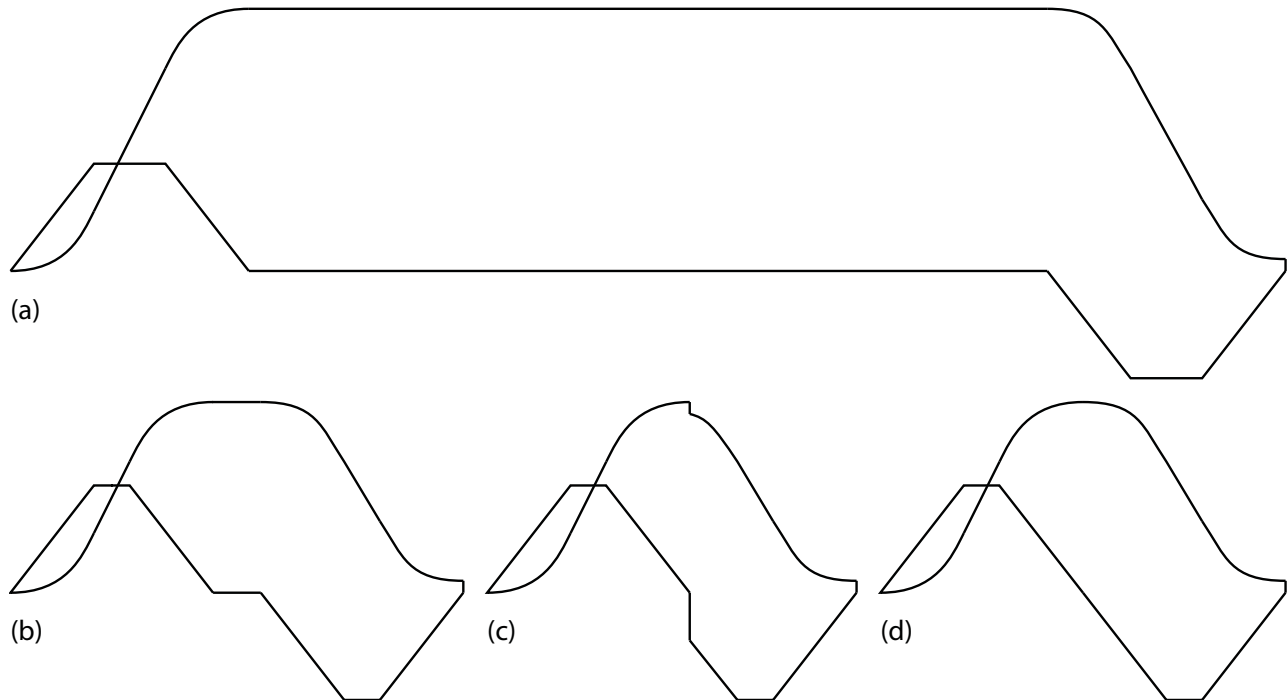

Velocity and Acceleration: (a) profile at contract speed; (b) insufficient lag compensation with profile at less than contract speed; (c) excessive lag compensation with profile at less than contract speed; (d) optimum lag compensation with profile at less than contract speed.

### Tuning

1. For initial setup, set the Profile Advance parameter, F7, 140, to 1 divided by response.
2. Depending upon drive tuning, the leveling distance may have to be generous to allow the elevator speed to completely transition to the requested leveling speed. For initial use, set the Leveling Distance parameter, F7, 160, to 2.0 inches. (Once the drive is tuned, this may be set to a more optimum value.)
3. Depending on drive tuning, the transition from leveling speed to zero speed may be sluggish. For initial use, set the Standard Slew Slope parameter, F7, 142, to 2.0 ft/s<sup>2</sup> or greater. (Once the drive is tuned, this may be set to a more optimum value.)

### Verify One Floor Run Operation

1. Run the elevator on Inspection between landings and verify that it moves properly.
2. After taking the elevator out of inspection mode, verify that the elevator corrects to a landing and stops properly.
3. Make a one floor run and observe the elevator as it moves between landings and stops at landings.

## Verifying Contract Speed Operation

1. Run the elevator between landings and verify that it moves properly.
2. Observe the elevator as it starts from landings, moves between landings, and stops at landings.
3. Progressively increase the number of landings traveled until contract speed is achieved. Initially, start with a Profile Scale of 75%. If the car runs as expected, slowly increase Profile Scale to 100%.
4. When the elevator achieves contract speed, verify speed through the F5, MPI-A diagnostics menu, address 16.
5. Place car on Normal operation and place a call to the top terminal. The car must land without a fault.
6. Place a call to the bottom terminal. The car must land without a fault.

### KEB/TorqMAX:

7. If speed is not correct, set LF.22 to a value between 125% and 150% of LF.25. Adjust final speed by increasing or decreasing the value of F7, parameter 148.

### Magnetek

8. If speed is not correct, adjust Contract Mtr Spd on the A1 Drive menu (higher RPM for increased speed) and adjust hoist motor speed, controller F7, 148.

## Measuring NTS and ETS Switch Locations

Floors must be learned before switch locations and speeds can be learned. The following description requires software version v8.0042 or later. If you are using an earlier version, substitute the MPI-C equivalent when MPI-A parameters are referenced. See [MPI-A Diagnostics on page 4-65](#) and [MPI-C Diagnostics on page 4-82](#).

1. Place the car on Inspection and move it to the middle of the hoistway.
2. Temporarily set speeds of ETS and NTS switches used on the job to 10 FPM over contract speed to prevent their influence.
  - DETS: F7 104                      • UETS: F7 75
  - DNTS5: F7 128                    • UNTS5: F7 99
  - DNTS4: F7 123                    • UNTS4: F7 94
  - DNTS3: F7 118                    • UNTS3: F7 89
  - DNTS2: F7 113                    • UNTS2: F7 84
  - DNTS1: F7 108                    • UNTS1: F7 79
3. Place car on Normal operation and place a call to the top terminal. The car must land without a fault.
4. Place a call to the bottom terminal. The car must land without a fault.

Highest numbered NTS switch **used** is farthest from terminal. NTS1 must always be within the terminal floor even when it is the only NTS switch used.

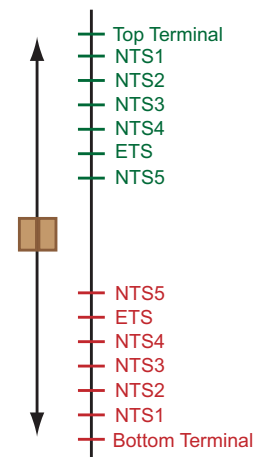

5. In the F5, Control Utility, MPI-A diagnostics menu, note and record distances from each terminal at 90%, 80%, 70%, 60%, 50%, and 40% of Contract Speed.

	Down	Up
• 90%	401	411
• 80%	402	412
• 70%	403	413
• 60%	404	414
• 50%	405	415
• 40%	406	416

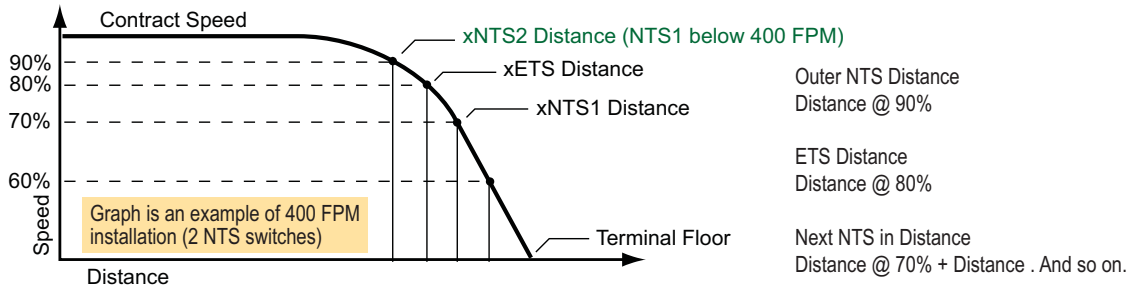

6. In the F7 menu, set top and bottom ETS switch distances to Distance @ 80% Contract Speed (UETS: F7 76, DETS: F7 105).
7. For NTS switches, at least U/DNTS1 must be used and placed within the top/bottom terminal landing. Outermost NTS will be U/D NTS5, NTS4, NTS3, NTS2, or NTS1 depending on number of switches used. Set outmost top and bottom NTS switches to Distance @ 90% CS.
8. Moving toward terminals, set the NTS just inside the ETS to Distance @ 70% CS, the next to Distance @ 60%, and so on.

Switch	UNTS5	DNTS5	UNTS4	DNTS4	UNTS3	DNTS3	UNTS2	DNTS2	UNTS1	DNTS1
Distance	F7 100	F7 129	F7 95	F7 124	F7 90	F7 119	F7 85	F7 114	F7 80	F7 109



## Terminal Learn

1. Move the car far enough from the top terminal to achieve contract speed.
2. Place on Test operation.
3. Set controller switch F5 UP.
4. Press N until Terminal Limits > Utilities Menu is displayed. Press S.
5. Follow the display instructions. Terminal Learn will only start in the UP direction.

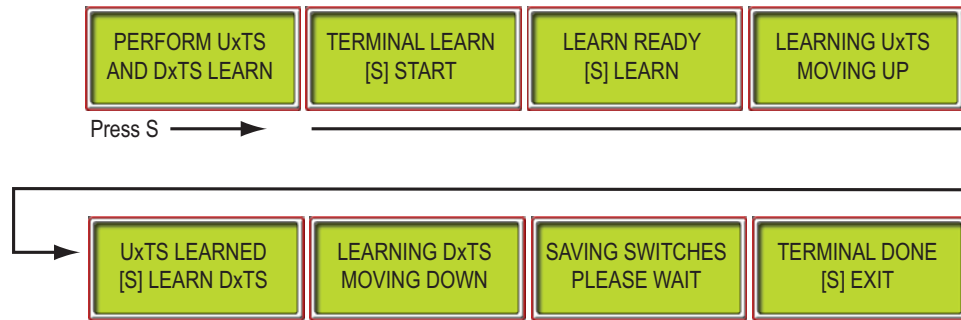

6. After pressing S to exit, place the F5 switch down.
7. Take the car off Test. Place the car on Inspection. Terminal learn is complete.

### Verify F7 Speed Values

Your values should be the appropriate percentage of your contract speed at each switch. Check up/down switch values:

1. U/DETS SPEED, 80% of Contract: UP, F7 75, DOWN F7 104.
2. Moving toward the terminals, verify consecutive NTS switch settings 90%, 70%, 60%, 50%, 40%:

Switch	UNTS5	UNTS4	UNTS3	UNTS2	UNTS1	DNTS5	DNTS4	DNTS3	DNTS2	DNTS1
Speed	F7 99	F7 94	F7 89	F7 84	F7 79	F7 128	F7 123	F7 118	F7 113	F7 108

### Set ETS Switch Delta Values

1. Set Delta Speed: UETS DELTA SPEED: F7 78, DETS DELTA SPEED: F7 107, 10% of learned speed value. Learned Speed @ switch + Delta Speed cannot exceed 95% of Contract Speed.

### Set NTS Switch Delta Values

For each NTS switch used, set DELTA LOW SPEED to 3% of Learned speed of appropriate switch. Set DELTA HIGH SPEED to 10% of Contract speed or 20 FPM, whichever is higher.

Switch	UNTS5	UNTS4	UNTS3	UNTS2	UNTS1	DNTS5	DNTS4	DNTS3	DNTS2	DNTS1
Delta Low	F7 102	F7 97	F7 92	F7 87	F7 82	F7 131	F7 126	F7 121	F7 116	F7 111
Delta High	F7 103	F7 98	F7 93	F7 88	F7 83	F7 132	F7 127	F7 122	F7 117	F7 112

## Adjustments

The preceding adjustments are good in most situations. If you are tripping speed faults and/or overshooting terminals, work with appropriate settings including:

- Delta speed margins
- Adjusting switch positions
- Adjusting deceleration and/or jerk rates
- Adjusting brake tension
  1. Adjusting deceleration/jerk rates will require relearning speed values.
  2. Moving switches will require a new Terminal Learn.

### If an ETSL switch is required:

- The ETS switch will be used as the ETSL and its position will be located at 90% of the reduced stroke buffer rated speed. ETSL Delta Speed will be 5% of the reduced stroke buffer rated speed. If ETSL is too far below the speed curve, you can adjust the Delta Speed closer to 10% of the reduced stroke buffer rated speed.
- The second-in NTS switch will be used as the ETS. The Delta Low Speed for the NTS switch will match the Delta High Speed so that the NTS switch will behave like an ETS.

### Short Floors Near a Terminal

When a short floor is located immediately preceding a terminal, the NTS1 switch must be located before the “landing” height of the short floor. (This is because the NTS1 switch remains the final correction for the positioning system. When it encounters NTS1, it knows that, regardless of any other information, the next stop is the terminal.) For example, the bottom terminal is at 0.0-inches. If the short floor is at 36 inches, the NTS1 switch must be located between 0.0 and 36-inches.

Figure 3.3 NTS1 Position with Short Floor

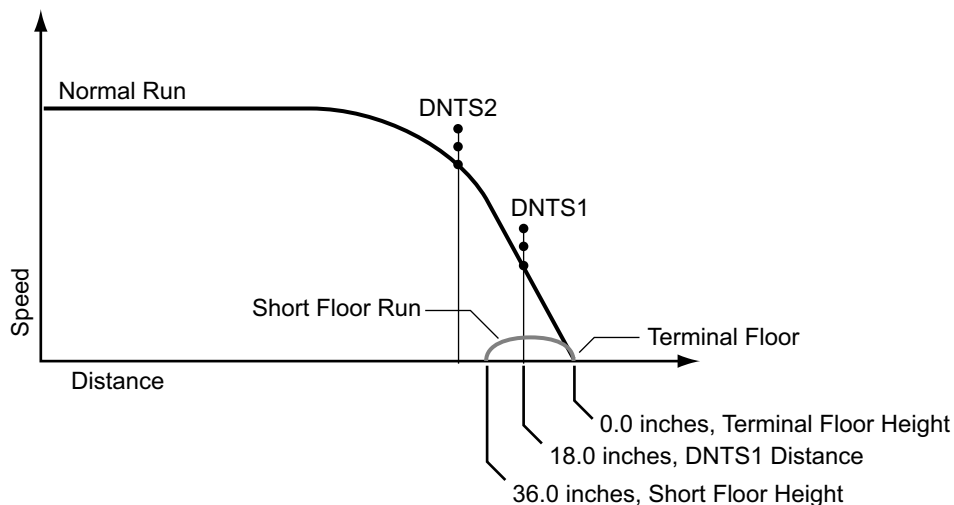

### Short Floor from 1 to 12-inches in Height

For short floors from one to twelve inches in height, the NTS1 switch cannot be used for over-speed detection. To avoid tripping overspeed errors in this situation, set the NTS1 switch speed significantly beyond the contract speed for the job, for example, 900 FPM.

## Additional Adjustment

### Tuning (Magnetek)

The Magnetek drive may require additional tuning to the motor:

#### Tuning Motor No-Load Current (HPV 600/900/900II)

1. To perform this procedure you will need to run the car at reduced speed with a balanced load. Motor torque should be below 15%.
  - Motor Torque, Flux Reference, and Est No Load Curr can be viewed on the drive D2 Power Data menu.
  - No Load Curr can be adjusted on the drive A5 Motor menu.
  - The car maximum speed can be changed via High Speed on the controller F7 menu, 150. (F7, 149, Contract Speed is used to set the rated speed for the car.)
2. Refer to Tuning No-Load Motor Current in the appendix of the Magnetek HPV AC Drive Technical Manual and follow that procedure.

#### Tuning Motor Flux Saturation Curve (HPV 600/900/900II)

1. To perform this procedure you will need to run the car at full contract speed with a balanced load.
  - Est No Load Curr can be viewed on the drive D2 Power Data menu.
  - No Load Curr and Flux Sat Slope 2 can be adjusted on the drive A5 Motor menu.
2. Refer to Tuning Rated Motor RPM in the appendix of the Magnetek HPV AC Drive Technical Manual and follow that procedure.

**Tuning Motor Rated RPM (HPV 600/900/900II)** Please see Tuning Motor Rated RPM in the appendix of the Magnetek HPV AC Drive Technical manual and follow that procedure.

#### Determining System Inertia (All Magnetek)

In order to properly tune the speed regulator of the Magnetek drive, a valid inertia value must be determined.

1. To perform this procedure, you will need to run the car at full contract speed with a balanced load.
  - Est Inertia can be viewed on the drive D1 Elevator Data menu.
  - Inertia can be adjusted on the drive A1 Drive menu.
2. Refer to Using the Software to Estimate the System's Inertia in the appendix of the Magnetek HPV AC Drive Technical Manual and follow that procedure.
3. With system inertia properly adjusted, final tuning of the speed regulator can be performed. The Response parameter on the drive A1 Drive Menu is one parameter that can be used to adjust the speed regulator. Please see the Magnetek HPV AC Drive Technical Manual for tuning/adjustment procedures.

### Relevel Operation

On Inspection, move the car to the bottom landing onto leveling. Take the car off Inspection and observe that it re-levels into the landing. If the car attempts to re-level but cannot:

1. If the car attempts to relevel but cannot:
  - Adjust Leveling speed parameter F7:158 to get the car to move.
  - Check that the car is not opening the down final limit.
2. If a fault code is displayed, troubleshoot and correct the fault.
3. Verify that the position indicator matches the car position.
4. Verify that the brake has been set as described in Section 2 to hold 125% of load, [Adjust Brake to 125% of Full Load on page 2-73](#).

### Brake Coordination

1. Adjust speed pick delay parameter F7:134 so that the brake is fully picked just as the motor first spins. The goal is to avoid spinning the motor before the brake is picked but not to introduce so much delay that rollback occurs.
2. KEB, TorqMAX: Refer to the Torqmax drive manual for information relating to speed pick delay interaction with pre-torque parameters.
3. Magnetek: Refer to Rollback Gain in the Magnetek HPV AC Drive Technical Manual.

### Run Tests

Register calls to all the landings in turn and observe that the car stops properly at the requested landing. As drive adjustments are made to tune performance, parameters on the controller F7 menu may need readjustment: Profile Advance, Leveling Distance, Leveling Dead Zone, Standard Slew Slope, Standard Stop Jerk, etc.

### Adjustment Problems

**Speed Changes Felt Excessively in Car** During high speed, if the speed change from accel to high speed or from high speed to decel can be felt excessively in the car:

- KEB: Decrease parameter A.LF.33 Ki speed offset accel and/or d.LF.33 Ki speed offset decel and d.LF.32 in steps of 100 to achieve smoother transitions. This may also be due to inaccurate drive adjustment, [Please refer to “Speed and Acceleration Control” on page 2-30](#).
- MAGNETEK: Consider Estimation of System Inertia, A0/A1 Response, A0/A1 Inner Loop Xover, A0/A1 Gain Reduce Mult, and A1/A0 Gain Chng Level.

**Loss of Control During Acceleration** Acceleration rate should be at least as great as deceleration rate but should not exceed deceleration rate by too much. Excessive acceleration rates may cause drive circuits to saturate and effectively lose acceleration control.

**Car Overshoots or KEB E.OL/E.OP or MAG Mtr Overload/Overvolt Flt**

- Refer to drive manual for error definition and troubleshooting instructions
- Check counterweighting is correct.
- Decrease Standard Acceleration, F7:168, Standard Deceleration F7, 169, Standard Roll Jerk F7/ 166, and Standard Stop Jerk, F7, 167.
- Increase drive gains, KEB LF.31 and LF.32 or MAG A0/A1 RESPONSE.
- Shut off power. Wait 1 minute to drain DC voltage from dynamic braking circuit. Verify no DC voltage with voltmeter.
- Check value of braking resistance (RB resistors). Check circuit connections and slip rings. (Approximately 3 times the measured brake coil resistance is a good starting point.)

**Car Oscillates at Contract Speed**

- Verify all motor parameters are correctly set and encoder is mounted well (no vibration).
- KEB/TorqMAX: Verify gain parameters KEB, A.LF.31 and A.LF.32 are not set too high.
- Magnetek: Verify Estimation of System Inertia, A0/A1 Inner Loop Xover, A0/A1 Gain Reduce Mult, and A0/A1 Gain Chng Level. Verify A0/A1 Response is not set too high.

## Placing Calls From the Controller

To place a call from the controller (or the hand-held):

- Place the F5 function switch up (all others down).
- Press S until Front Call Registration is displayed.
- Refer to the illustration below.

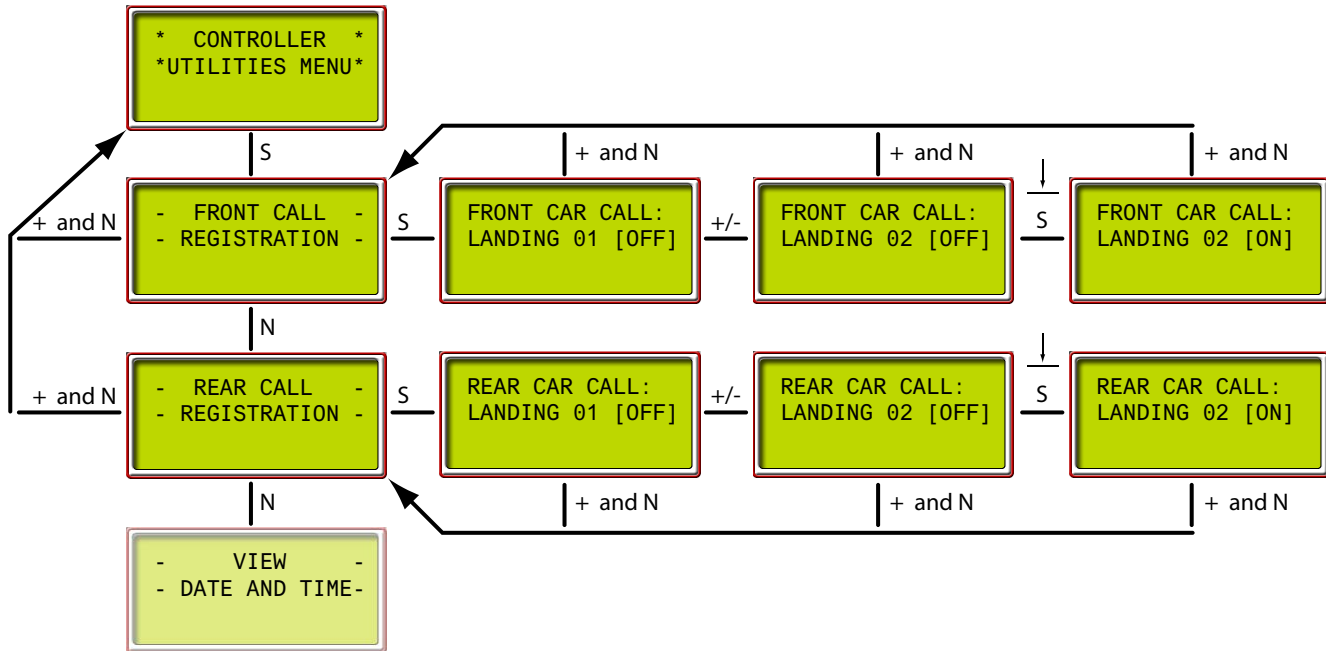

- +/- to increment or decrement floor numbers
- Press and momentarily hold S to register calls; displays [ON] while held
- Press + and N together to back out of the current display

**If the car opens a Final Limit** If the car overshoots a terminal and opens the Final Limit switch, power will immediately be removed from the machine and brake and the car will come to an immediate stop. If this occurs, it means the Final Limit switch is incorrectly positioned (check job prints), that differential gain or other motor settings are incorrect, or that the “virtual” slowdown switches selected for the performance curve are too aggressive.

1. Check the Final Limit switch position at both terminals against the job prints.
2. Check all motor and encoder related settings.
3. Slightly increase differential gain settings and/or incrementally move virtual terminal slowdown switches away from the terminal landing.
4. Retest.



If a Final Limit Switch has opened, you will need to place the car on Inspection operation and temporarily “jumper out” the limit switch while you move the car to the terminal landing.

**If the car does not leave a landing**

- If the elevator is trying to level, it will not pick high speed and leave the landing until it completes leveling.
- Check status of SAFL. Verify door locks are made.
- Verify Auxiliary Speed (F7, 153) not set to 0.0 FPM.
- Verify Acceleration and Start Jerk settings.
- If any of the inputs that open the door are active (Safety Edge On, Photo Eye On, etc.) or if the UIO board car call terminal for the current floor (floor displayed in PI) is grounded the car will not move.

**Load Testing AC Drives**

1. Add 100 or 200 pounds of test weights to the car.
2. Observe current draw as the car is accelerating.
3. Repeat until rated load is achieved, looking for:
  - Overload drive errors, indicating that the drive is being pushed close to its limits and may require:
    - If requested acceleration rate is excessive, reduce acceleration rate. The lower the acceleration rate, the lower the current demand.
    - Adjust jerk for a more gradual transition from acceleration to high speed.
    - Adjust drive gains.
    - The motor may be underrated. Try reducing the motor speed setting slightly.
    - Check for proper counterweighting. (With a balanced load, drive/motor current should be the same in both up and down directions.)
    - If needed, make a copy of the drive parameter table and write down all settings. Contact MCE for assistance.

**Trouble Slowing with a Full Load**

If there is an issue with slowing a fully loaded car in the down travel direction, or if the AC drive is tripping off with an over voltage fault displayed, it may mean that there is a problem with regenerative braking or with the brake control module (if supplied).

Refer to the drive manufacturer manual. Generally:

- 230V drive will trip on over voltage if the DC bus Peak voltage reaches about 400 Volts or if standard DC bus voltage reaches about 325 Volts.
  - 460V drive will trip on over voltage if the DC bus Peak voltage reaches about 800 Volts or if standard DC bus voltage reaches about 650 Volts.
1. With the drive in operating mode, check DC bus and DC bus Peak voltage displays while the car is slowing with a full load in the down direction.

**Danger**

If you choose to actually measure the voltage across the drive power terminals, exercise extreme care. These voltages are lethal.

2. Measure the voltage across the controller braking resistors. If there is no measured voltage (car slowing/full load/descending or car slowing/no load/ascending), there may be a wiring problem or a defective brake module.
3. Investigate and solve this problem. The regenerative resistors or the brake module regulate car speed during full load down or empty load up conditions and are critical to safety. Contact MCE if necessary.

## Electrical Noise

If the motor makes excessive electrical noise or draws higher than normal current:

- Check Encoder Polarity (KEB, TorqMAX) on page 2-47 or Align Encoder (Magnetek) on page 2-47.
- Check KEB LF.29. Try changing it from 4 to 8 or from 8 to 16.
- Verify traction sheave diameter and correct entry in drive parameter.
- Verify machine gear reduction ratio and correct entry in drive parameter.
- Verify Rated Motor Speed and correct entry in drive parameter.
- Verify acceleration and deceleration integral and proportional gain drive settings. Refer to drive manufacturer manual for detail.

### Note

Imperial motor nameplates list full load RPM. With induction motors, this value is equal to synchronous RPM less slip. If your motor lists only synchronous RPM, you must determine its slip percentage and subtract that amount to arrive at rated motor speed.

For example, a Reuland motor in a flux vector application has slip between 1.8% and 2.0%. If synchronous RPM is 1200, 1.8% of that is about 22 RPM so rated motor speed would be 1200 minus 22 = 1178 RPM. (F5 drive parameter LF.11. If you auto-tuned the drive to the motor, this parameter is learned and should not become a problem.)



## Load Weigher

Information from the load weigher is used for pre-torquing and for dispatching decisions, e.g. light load anti nuisance, heavy load, and overload.

- Installing the Load Cells (Sensors)
- Installing the Control Unit
- Control Unit description
- Load Weigher calibration
- Final calibration
- Installation with 2 to 1 roping
- Verifying zero calibration (empty car weight)
- Troubleshooting

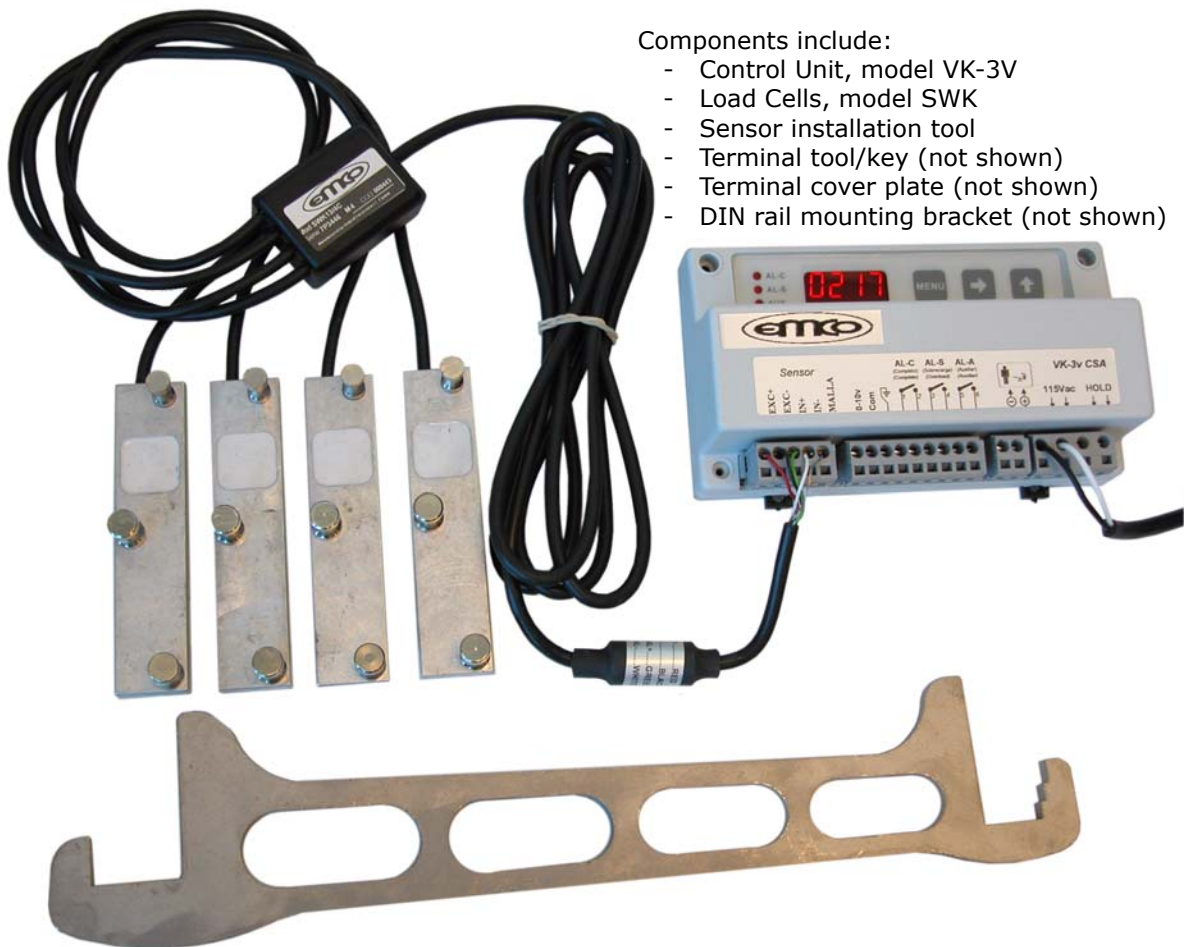

Components include:

- Control Unit, model VK-3V
- Load Cells, model SWK
- Sensor installation tool
- Terminal tool/key (not shown)
- Terminal cover plate (not shown)
- DIN rail mounting bracket (not shown)

## Analog Voltage or Relay Closure

The weigher provides both an analog output (0 - 10V) for analog weighing and relay closure outputs for discrete weighing inputs. Check the CT (Cartop) drawings in your job prints to see how your load weigher is connected.

## Installing the Sensors

Install sensors using the leverage tool supplied. In some instances it may be necessary to use an extender on the handle to gain more leverage.

Typically the sensors are mounted on the wire ropes directly above the cartop hitch. However, with 2 to 1 roping the sensors must be mounted below the dead-end hitch beneath the overhead.

Please refer to “Installation with 2 to 1 Roping” on page 3-27.

1. Notice that one of the sensor pins moves in and out. Move the pin to the in position as shown.
2. Place the sensor on the wire rope and apply leverage to rotate the sensor until the pin can be moved to the out position as shown.

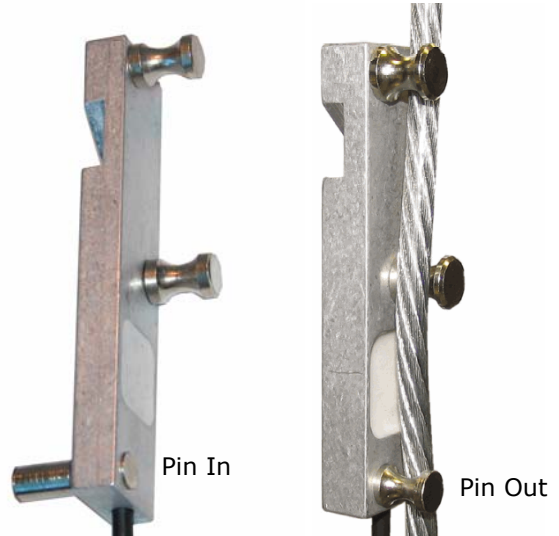

### Installation with 2 to 1 Roping

When the EMCO load weigher is used with 2 to 1 roping, the sensors must be installed just below the dead-end hitch, as shown and do not travel with the car.

Therefore, we recommend that in these cases the EMCO control unit be mounted in the controller cabinet. The signal wires from the load cells must be routed through the overhead to the machine room. The sensor wires, which are only 6 feet in length, must be extended. Use a terminal block to join wire lengths and route wires through conduit.

We recommend enabling the Auto-zero Calibration option for 2 to 1 roping installations. [Please refer to “Auto-zero Calibration” on page 3-33.](#)

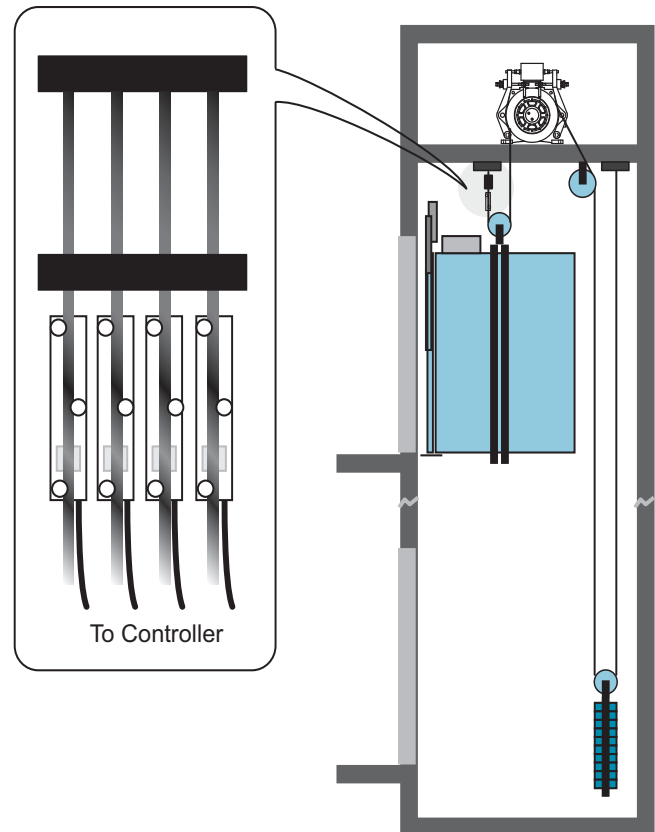

## Installing the Control Unit

The control unit may be mounted using the DIN mounting bracket supplied or using the holes in the unit itself. For 1:1 roping, the EMCO unit is mounted on the cartop. For 2:1 roping, the EMCO unit is mounted in the controller cabinet.

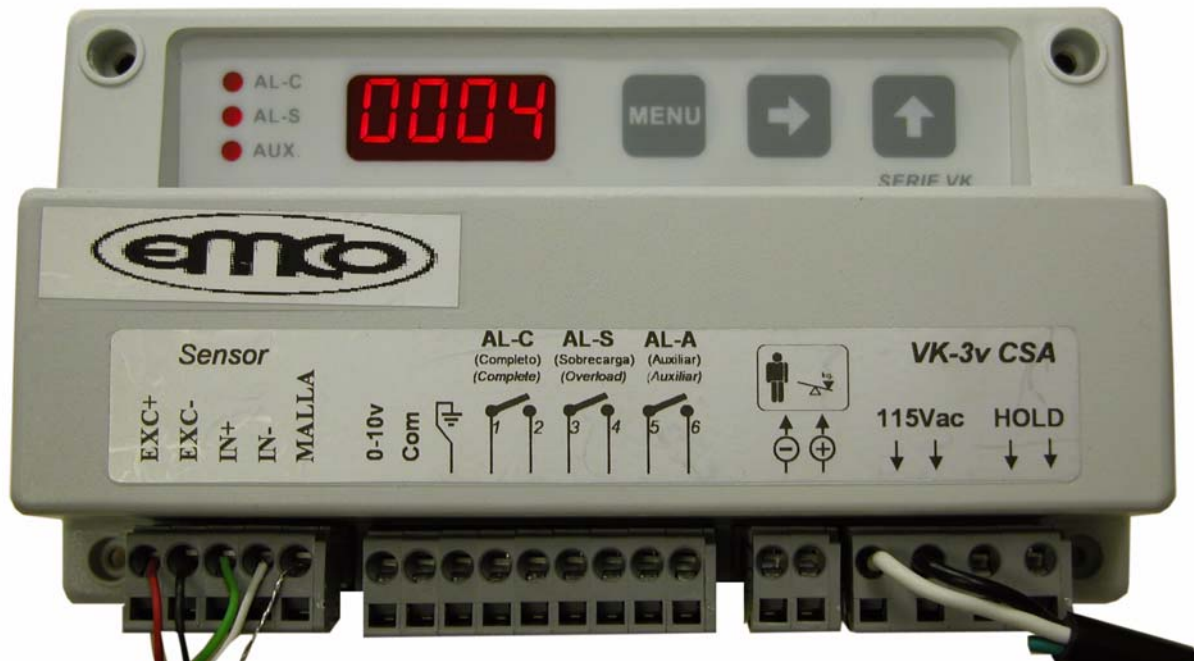

1. EMCO control unit to cartop box (1:1 roping) or controller (2:1 roping):
  - Connect one of the terminals directly below the 115Vac label to the controller 1 bus
  - Connect the second terminal directly below the 115Vac label to the controller 2 bus
2. Sensor wires connect to the control unit as indicated on the wire:
  - red wire to terminal EXC+
  - black wire to terminal EXC-
  - green wire to terminal IN+
  - white wire to terminal IN-
  - shield wire to terminal MALLA

Use the Terminal tool/key (wire insertion tool), or a narrow flat blade screwdriver to open the detent in the terminal connector to allow insertion of the tinned wires.

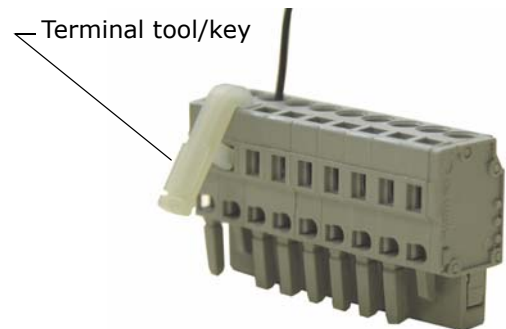

For 2:1 roped units, route the sensor wires through the overhead to the machine room. The sensor wires, which are only 6 feet in length, must be extended. Use a terminal block to join wire lengths and route wires through conduit.

## Analog Weigher Output Wiring

For analog weighers:

1. Connect the EMCO terminal labeled “Com” to the controller 1 bus.
2. Connect the 0 - 10V output to the I/O 16 / LW+ input of the UIO board shown in your job prints.





## Relay Closure Output Wiring

For relay closure outputs:

1. Refer to your job prints.









## Controls Overview

Use control unit buttons to program the weigher:

- Press the  menu button until the desired parameter is displayed.
- Press the  button to select the digit to be modified (digit blinks when selected).
- Press the  button to change the digit.
- Press the  menu button twice to save the new value. Once a value is saved, the control will display the next parameter.
- If you do not press the  menu button twice, the changes will not be stored and the control display will continue to show the parameter you were previously modifying.

## Menu Order







Pressing the  menu button will scroll through the Installation Menu in the following order:

	Measured weight in car (value displayed varies with load in car)
	Relay C set point (also sets the analog output 10Vdc reference value)
	Relay S set point
	Relay A set point
	Learn empty car weight (Zero weight)
	Learn full load weight (Calibrate with Weights)
	(not used)
	Auto zero calibration (used as required)
	Confirmation

## Calibration



### Manual Calibration with Weights

This procedure allows the EMCO control unit to do the following:

- Learn the empty weight of the car and set this weight as the zero reference (the analog voltage output from the control unit will be about zero volts at this weight).
- Learn a known weight. You place a known weight in the car and enter it into the control unit. The load weigher will then learn this weight.
- If you are using the analog output, you will enter the car overload weight value. The control unit uses this information to scale the analog output so that, at the point the sensors detect overload conditions, the analog output is about 10 volts. The analog output from empty to overload weight will be linear from about 0.0 to 10.0 volts.
- If you are using the relays, you will enter the set points for each relay.
  1. Before programming or calibrating the sensors and control unit:
    - Bring car to the lowest floor of its total travel.
    - Bounce in car to verify that it is free on guide rails.
  2. Verify that the sensors are properly connected to the control unit.
  3. Power up the control unit and verify that the input voltage is within the voltage range of the control unit.
  4. Verify that the sensors are installed on the wire ropes per the previous instructions.
  5. Learn the empty car weight (Zero the control unit):
    - Press the  menu button until **CEr0** is displayed.
    - Press the  button once. The display will flash.
    - While the display is flashing, press the  menu button once. If the display stops flashing before you press the menu button, you must start over.
    - The control unit display begins to count down. Exit the cartop before the countdown finishes.
    - When the zero calibration is complete, **PE50** will be displayed. If **PE50** is not shown, the value has not been saved and this step must be repeated.
  6. Learn a known weight (full load is recommended):
    - Press the  menu button until **PE50** is displayed, if it is not shown already.
    - Place a known weight in the car (full load recommended).
    - Enter the value of the known weight. Press the  button to select a digit (blinks when selected) and press the  button to set the value.





#### Note

If the overload weight (125% of full load) will exceed 9999 lbs, use a percentage of the full load weight instead. For example, if full load weight is 9,000 lbs, scale it to 80% by entering 7200. That way, overload weight will be under 9999 lbs (9000 lbs with the given example).







- Press the  menu button twice. The control unit will begin to count down. Exit the cartop before the countdown finishes. When the known weight has been learned,  will be displayed. You can press the  menu button until the weight is shown on the control unit display. The weight displayed should be the value of the weights in the car, or the scaled value.















Complete steps 7, 8, and 9 only if the load weigher analog output will be used (references the analog output to 10Vdc at this weight). Go to Relay Setup for relay output weighing.

7. Enter the overload weight:

- Press the  menu button until  is displayed.
  - Enter the value of the overload weight (or the scaled value if you scaled full load weight - use the same scaling factor). Press the  button to select a digit (blinks when selected) and press the  button to set the value.
  - Press the  menu button three times to save your entries.
8. With the full load of weights in the car, using a digital multimeter, measure the voltage at terminals **0-10v** and **Com** on the control unit. It should be approximately 8 volts. Note the exact value.

### Relay Setup

9. For discrete relay closure weighers, the set points for relays AL C, AL S, and AL A must be programmed as shown in the job prints, typically -
- Light Load - 25% or less of full load, relay ON/normally closed
  - Dispatch Load - 60% of full load, relay OFF/normally open
  - Heavy Load - 80% of full load, relay OFF/normally open
  - Overload - 100% of full load, relay OFF/normally open
  - Overload 2 - 125% of full load, relay OFF/normally open
1. Enter the trip point for relay AL C - (EMCO terminal #2 on the job prints).
- Press the  menu button until  is displayed.
  - Enter the value of the desired trip point weight (or the value of the weight scaled by the same percentage used in step 6). Press the  button to select a digit (blinks when selected) and press the  button to set the value.
  - Press the  menu button once. The display indicates “On” which means normally closed (contacts will open when weight exceeds set point). Press the  button if you want to change it to “Off”, normally open (contacts will close when weight exceeds set point).
  - Press the  menu button twice to save the settings.

2. Enter the trip point for relay AL S - EMCO terminal #4 on the job prints).
  - Press the  menu button until  is displayed.
  - Enter the value of the desired trip point weight (or the value of the weight scaled by the same percentage used in step 6). Press the  button to select a digit (blinks when selected) and press the  button to set the value.
  - Press the  menu button once. The display indicates “On” which equals normally closed. Press the  button if you want to change it to “Off”, normally open. Press the  menu button twice to save the settings.
3. Enter the trip point for relay AL A - EMCO terminal #6 on the job prints).
  - Press the  menu button until  is displayed.
  - Enter the value of the desired trip point weight (or the value of the weight scaled by the same percentage used in step 6). Press the  button to select a digit (blinks when selected) and press the  button to set the value.
  - Press the  menu button once. The display indicates “On” which equals normally closed. Press the  button if you want to change it to “Off”, normally open. Press the  menu button twice to save the settings.

### Controller Parameters

- If the load weigher is used for dispatching options, e.g., light load anti-nuisance, dispatch load (lobby door dwell cancel), heavy load (hall call bypass) or overload options, the controller needs to learn the empty and full load weights at every landing available to this car.
- If the load weigher will be used to implement dispatching options, the parameters associated with these options must be set. Please refer to the *Adjusting the Load Thresholds* section of this manual







## Auto-zero Calibration

The EMCO load weigher has an auto-zero calibration option which can be used if needed. Typically this option is recommended for 2 to 1 roping or where guide shoes, rather than guide rollers, are used.

### How auto-zero calibration works:

- The control unit must see no power on the Hold terminals. (Some installations use these terminals to indicate when the doors are closed but these terminals are not used with MCE controls.)
- The CAde parameter must be set to 50.
- When the control unit senses no change in weight for two minutes, it automatically performs the CEro zero load calibration (learns the empty car weight).

### To enable auto-zero calibration:

1. Press the  menu button until `CAde` is displayed.
2. Enter the value 50. Press the  button to select a digit (blinks when selected) and press the  button to set the value.
3. Press the  menu button twice to save the value.

## Analog Weigher Additional Calibration

1. Connect the multimeter across UIO IO16 and Common. Verify that the reading is the same as the measurement at terminals 0-10v and Com on the EMCO control unit.
2. To verify the linearity of the load weigher, place weights in the car that represent the following and observe the voltage values:
  - Empty car - about 0.0 volts
  - 25% of overload weight - about 2.5 volts
  - 50% of overload weight - about 5.0 volts
  - 75% of overload - about 7.5 volts
  - Full load weight - about 8 volts
  - Overload weight - about 10 volts.

## Verifying Empty Car Weight for Analog Weighers

We recommend verifying zero calibration:

- If the ropes are new calibration may change slightly as the ropes stretch. After the first 30 days of operation, check the empty car weight, with the car in the middle of the hoistway, using the display on the EMCO Load Weigher. If the empty car weight has changed (no longer zero), the empty car weight must be re-learned.
- If the car experiences violent motion (emergency stop, buffer contact, etc.), verify zero calibration as described above.

### Troubleshooting

1. Check for error codes on the display.

**Err1** = Bad load cell connection or damaged load cell. Verify load cells are connected to the control unit per the wiring diagram. Inspect cables for cuts or broken wires.

**Err2** = Negative load cell flow. Verify load cell connections to the control unit are per the wiring diagram.

**Err3** = Positive load cell flow. Load cells are too small for the application and must be replaced with proper units.

**Err4** = Polarity error. Verify load cell connections to the control unit are per the wiring diagram. Reprogram the control.

**Err5** = MB-D display short. Locate the short. Disconnect MB-D display, turn off the control, then reconnect the MB-D display.

**Err6** = Loss of data in memory. Reprogram the control.

2. Verify that proper voltage is being supplied to the control unit.
3. Check all connections to the control unit.
4. Check the fuse: Disconnect power to the control unit. Open the unit by removing the five (5) screws that hold the cover. Remove fuse from black fuse holder next to controller transformer and replace with new fuse if necessary.

## Final Tests

The following tests may be performed in the process of elevator acceptance testing.

- Safety String Test, [Safety String Test on page 3-38](#)
- Motor/Brake Contactor Proofing Tests, [Motor Contactor Proofing Test on page 3-38](#)
- Directional Limits Test, [Directional Limits Test on page 3-39](#)
- Final Limits Test, [Final Limit Tests on page 3-40](#)
- Car and Counterweight Buffer Tests, [Buffer Tests on page 3-41](#)
- Inspection Overspeed Test, [Inspection Overspeed Test on page 3-42](#)
- Contract Overspeed Test, [Contract Overspeed Test on page 3-42](#)
- Leveling Overspeed Test, [Leveling Overspeed Test on page 3-42](#)
- Normal and Emergency Terminal Switch Overspeed Tests, [Normal and Emergency Terminal Switch Tests on page 3-43](#)
- Electrical Governor Test, [Electrical Governor Test on page 3-44](#)
- Car/Counterweight Safety Test, [Safety Tests on page 3-45](#)
- Emergency Brake Test - Unintended Motion, [Emergency Brake Test - Unintended Motion, Rope Brake on page 3-47](#)
- Emergency Power tests, [Emergency or Standby Power Operation on page 3-53](#)



### Caution

In this document, overspeed tests ask you to scale a run speed by 110% in order to exceed the respective overspeed for that setting. This is almost always adequate. However, if the speed required for the test exceeds 110% of contract speed, you will need to increase the scaling percentage, F7-141, to compensate. Otherwise, the overspeed will not be detected which, in some tests, may result in a car or counterweight unintentionally hitting a buffer or overhead.

**Always have a technician standing by to shut down the elevator if necessary.**

## Often Used Procedures

Following are some procedures and techniques that are often used while performing acceptance testing:

### How to check Car Speed:

1. Place Function Switch F3 on the HC-MPU board in the ON (up) position.
2. Press the N push button until CONTROLLER SYSTEM MENU is displayed.
3. Press the S push button to select the menu.
4. Press the N push button until POSTN and SPEED are displayed.
5. Run the car. Speed is displayed in feet per minute.

### How to place the car on Inspection Mode Fault Bypass:

1. On the HC-MPU board, place Function Switch F3 in the ON (up) position.
2. On the HC-CTL board, use a jumper to short the pins of JP1 Fault Bypass.
3. Press the N push button until CONTROLLER SYSTEM MENU is displayed.
4. Press the S push button to select the menu.
5. Press the N push button until INSPECTION MODE FAULT BYPASS is scrolled on the display.
6. Press the S push button to change the setting to BYPASS ON.

### How to place the car on Automatic Mode Fault Bypass:

1. On the HC-MPU board, place Function Switch F3 in the ON (up) position.
2. On the HC-CTL board, use a jumper to short the pins of JP1 Fault Bypass.
3. Press the N push button until CONTROLLER SYSTEM MENU is displayed.
4. Press the S push button to select the menu.
5. Press the N push button until AUTOMATIC MODE FAULT BYPASS is scrolled on the display.
6. Press the S push button to change the setting to BYPASS ON.

### How to access/set the F7 parameters:

**Important** Once set at the factory, F7 parameters are protected by positioning a jumper on the HC-CTL board. Before you can access F7 parameters, you must set the jumper appropriately and be on Inspection mode:



1. On the HC-MPU board, place Function Switch F7 in the ON (up) position.
2. Press the N push button to begin. DOWNLOADING PARAMETERS FROM MPU is scrolled followed by parameter zero, ADJUST FLOOR 01F POSITION....
3. The parameters are numbered 0 through xxx. Press the N push button to advance to the next parameter. Press and hold the N push button to advance at high speed. Press the N plus minus (-) push buttons to move to the previous parameter.
4. Use the plus (+) and minus (-) push buttons to change the parameter setting.
5. When you have finished setting parameters, press the S push button to exit the menu. ADJUST COMPLETE, PRESS (S) TO STORE is scrolled on the display. Press the S push button to store your changes. STORING VALUES... is displayed followed by VALUES STORED.

**Note**

A table of F7 values is included in this section, [F7 Parameters on page 3-47](#).

### How to Reset Excessive Faults

Many of the faults generated while performing acceptance tests are self-resetting once the fault condition is corrected. However, this controller has excessive faults logic which will generate an EXCESSIVE FAULTS SHUTDOWN if more than the established limit of faults occur within the circumscribed period of time. To reset this fault:

- Press the Fault Reset button on the HC-CTL board.

#### Note

You can review speed and position information through an F5-accessed menu for assistance in seeing what is actually happening in the hoistway. [Please refer to “MPI Diagnostic Menu” on page 4-64.](#)

### Safety String Test

This test verifies the Safety String is working correctly.

#### SAFH Safety String Test

1. Remove the wire from PMT terminal 15 or activate any safety device in the string.
2. A safety message will scroll on the MPU display.
3. Verify that the Safety Relay has dropped out and that the car cannot be run.
4. Reinstall the wires.

#### SAFC Safety String Test

1. On the CTL board, remove all wires from the SAFC input or activate any safety device in the string.
2. The message CAR SAFETY DEVICE OPEN should scroll on the MPU board display.
3. Verify that the Safety Relay has dropped out and that the car cannot be run.
4. Reinstall the wires.

### Motor Contactor Proofing Test

This test simulates a stuck motor contactor. The test should be performed with the car stopped and with the car in motion. Once the fault is generated, the car should not be allowed to move until the contactor is unstuck.

#### Car Stopped at Floor

This test is performed with the car stopped at a floor.

1. Use a non-metallic object to activate the PM contactor.
2. Observe that the car will not run. MPU displays “PMP input failed to activate”.

#### Car in Motion

The car is in motion when this test is performed.

1. Place a call.
2. Once the car is in motion, use a non-metallic object to activate and hold the PM contactor “on”.
3. After the car stops at the designated floor, verify that it will not continue to run.

## Brake Contactor Proofing Test

This test simulates a stuck brake contactor. The test should be performed with the car stopped and with the car in motion. Once the fault is generated the car should not be allowed to move until the contactor is unstuck.

### Car Stopped at Floor

This test is performed with the car stopped at a floor.

1. Use a non-metallic object to activate the BR contactor.
2. Verify that the car will not run. MPU displays “BRP input failed to activate.”

### Car in Motion

The car is in motion when this test is performed.

1. Place a call.
2. Once the car is in motion, use a non-metallic object to activate and hold the BR contactor “on.”
3. After the car stops at the designated floor, verify that the car will not continue to run. (A UIM, unintended motion fault, may occur if the car drifts far enough.

## Directional Limits Test

These tests verify proper operation of elevator up and down direction limits.

1. On the MPU board, verify that F7 parameter #68 Direction Limit Distance is set to the desired distance.
2. Verify that the F3 > Controller System Menu > Inspection Mode Fault Bypass parameter is set to BYPASS OFF.

### Down Direction Limit Test

1. On Inspection, run the car to the floor above the bottom landing.
2. On Inspection, run the car down below the bottom landing until the car stops.
3. Verify that the Final Limit has not opened and that the car has stopped at approximately the distance set in F7 parameter # 68 Direction Limit Distance.

### Up Direction Limit Test

1. On Inspection, run the car to the floor below the top landing.
2. On Inspection, run the car up past the top landing until the car stops.
3. Verify that the Final Limit has not opened and that the car has stopped at approximately the distance set in F7 parameter # 68 Direction Limit Distance.

### Final Limit Tests

1. Place the car on Inspection.
2. On the MPU board, set F3 > Controller System Menu > INSPECTION MODE FAULT BYPASS = BYPASS ON. The MPU display will scroll FAULT BYPASS IS ACTIVE (INSPECTION).

### Lower Final Limit Test

1. Place the car one floor above the bottom landing.
2. Run the car down on Inspection until it stops. The MPU display will scroll the message HOISTWAY SAFETY DEVICE OPEN.
3. On the HC-CTL board, place a jumper between 2 bus and the SAFH input terminal.
4. Run the car up on Inspection.
5. Remove the jumper between 2 bus and the SAFH input terminal on the HC-CTL board.

### Upper Final Limit Test

1. Place the car one floor below the top landing.
2. Run the car up on Inspection until it stops. The MPU display will scroll the message HOISTWAY SAFETY DEVICE OPEN.
3. On the HC-CTL board, place a jumper between 2 bus and the SAFH input terminal.
4. Run the car down on Inspection.
5. Remove the jumper between 2 bus and the SAFH input terminal on the HC-CTL board.
6. Set F3 > Controller System Menu > INSPECTION MODE FAULT BYPASS = BYPASS OFF.



## Buffer Tests

Buffer tests verify that the car or counterweight striking the buffer will cause the machine to break traction and that the buffer will return to its fully extended state after having been fully compressed. Following the car buffer test, the counterweight buffer test is executed with an empty car running up.



### Note

These test instructions are written with the expectation that the car or counterweight will be traveling at contract speed when it strikes the buffer. If reduced stroke buffers are used, this speed must be reduced to equal the rated speed of the particular buffer.

### (Car) Buffer Test

1. Place a full load in the car.
2. Run the car to the top landing
3. Place the car on Inspection.
4. On the MPU board, set F3 > Controller System Menu > INSPECTION MODE FAULT BYPASS = BYPASS ON. The MPU display will scroll FAULT BYPASS IS ACTIVE (INSPECTION). Return F3 to the down position.
5. Place a jumper between the 2 Bus and SAFH.
6. Verify F7, 149, CONTRACT SPEED is set correctly (contract speed for normal testing; reduced stroke buffer rated speed for reduced stroke buffers).
7. Place function switch F5 in the UP position and press N until the TERMINAL LIMIT/UTILITIES menu is displayed. Press S to select.
8. Press N until PERFORM TERMINAL TESTS is displayed. Press S to select. TERMINAL TEST RUN/QUIT will be displayed. Press S to start the test.
9. With TERMINAL TEST ARM/QUIT displayed, press S. The LCD will display TERMINAL TEST - READY TO MOVE.
10. Display car speed – F3 > Controller System Menu > POSTN/SPEED.
11. Run the car down using the Machine Room Inspection switches. (If you are in the F5 menu, you will see TERMINAL TEST IN PROGRESS.)
  - Release the switches when the car contacts the buffer and the ropes lose traction.
  - Car must strike buffer, compress it fully, and cause hoist motor to break traction.
  - Check hoistway ropes are still in their grooves before attempting to move car again.
12. If you are in the F5 menu, it will display TERMINAL TEST DONE, PRESS S. Press S.
13. Exit the F5 menu (if used). Return F7 parameters to their original settings (if used).
14. Remove 2 Bus/SAFH jumper. Set INSPECTION MODE FAULT BYPASS to OFF.

## Inspection Overspeed Test

This test verifies that moving the elevator on Inspection at a speed greater than the Inspection Overspeed setting will result in an emergency stop.

1. On the MPU board, verify that F3 > Controller System Menu > INSPECTION MODE FAULT BYPASS = OFF.
2. Change F7 parameters to:
  - 141 PROFILE SCALE = 115% of INSPECTION OVERSPEED
  - 187 REDUCED INSPECT SPEED = OFF
3. Run the car up or down on Inspection.
4. An emergency stop will be performed when 146 INSPECTION OVERSPEED value is exceeded.
5. MPI A, B, C INSPECTION OVERSPEED will be displayed.
6. Return F7 parameters to their original settings

## Contract Overspeed Test

This test verifies that moving the elevator at a speed greater than the Contract Overspeed setting will result in an emergency stop.

1. Move the car to bottom floor on Normal operation.
2. KEB/Torqmax only. Set drive LF.22 to a value greater than LF.25 x 1.4
3. Set F7 Parameter 141 PROFILE SCALE = 120.0%
4. Place a call to the top floor.
5. When car speed exceeds Contract Overspeed setting, it must:
  - Perform an emergency stop.
  - Generate message MPI A, B, C CONTRACT OVERSPEED.
6. Return F7 and (KEB/Torqmax only) drive parameters to their original settings.

## Leveling Overspeed Test

This test verifies that the car will perform an emergency stop if, while leveling, it is traveling at a speed greater than the Leveling Overspeed setting.

1. Set parameter #158 to 2 or 3 (leveling speed). Set parameter #147 = 1 (leveling over-speed), #160 = 5 inches, F1>Door Operation Menu > Preopening = Yes.
2. Call to floor not near limits. As car is leveling: Emergency stop, display MPI-A, B Leveling Overspeed.
3. Return parameters to original values.

## Normal and Emergency Terminal Switch Tests

Obtain a list of learned speeds at all ETS and NTS switches used. At contract speeds below 400 FPM, verify F7 parameters:

- #70 NTS1 = VIRTUAL
- #69 U/DETS = VIRTUAL
- #74 NTS5 = UNUSED
- #73 NTS4 = UNUSED
- #72 NTS3 = UNUSED
- #71 NTS2 = UNUSED (VIRTUAL if 400 FPM or higher contract speed)
- $xNTSn \text{ SPEED} = \text{Speed value of switch}$
- $xNTSn \text{ DISTANCE}$  - Switch to terminal distance
- $xNTSn \text{ DELTA DISTANCE}$  - Margin of error allowed to not see switch
- $xNTSn \text{ DELTA LOW SPEED}$  - Positive offset from  $xNTSn \text{ SPEED}$  value for DELTA LOW SPEED FAULTS
- $xNTSn \text{ DELTA HIGH SPEED}$  - Positive offset from  $xNTSn \text{ SPEED}$  value for DELTA HIGH OVERSPEED FAULTS

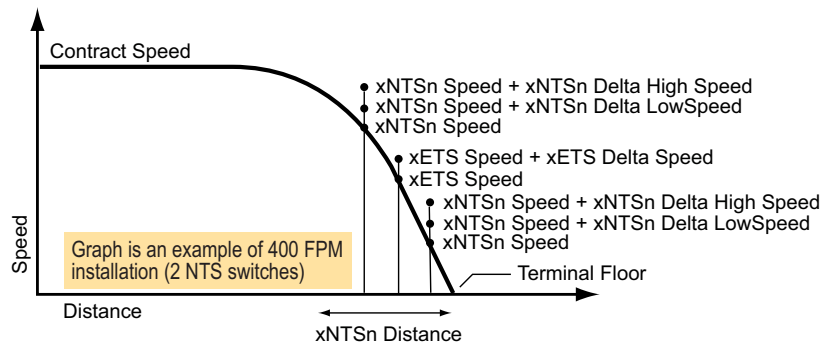

### Outer NTS Delta High Speed Test

1. Set Delta Low Speed of outer UNTS switch to 60 FPM to move it “out of the way”. Move car away from top landing far enough to reach contract speed. Put in TEST MODE.
2. Set HC-MPU switch F5 UP. Press N until Terminal Limit Utilities appears. Press S. Press N until Perform Terminal Tests appears. Press S.
3. With TERMINAL TEST/CMD: DN [N]-QUIT displayed, press S to display Terminal Test [S]-Run [N]-Quit. Press S to display Terminal Test/Cmd: DN [N]- displayed, use +/- buttons to select UP. Press S.
4. GOING TO TOP will be displayed. Set F5 down while traveling. When the car performs an uncontrolled emergency stop, it will display UNT SW HIGH OVERSPEED.
5. Set F5 up. Press + and N buttons to exit terminal tests. Return Delta Low Speed to original setting.
6. Repeat test for down direction outer DNTS switch.

### Outer NTS Delta Low Speed Test

1. Set Delta High Speed for outer UNTS switch to 60 FPM to move it “out of the way”. Move the car away from the top landing far enough to reach contract speed. Put in TEST MODE.
2. Set HC-MPU switch F5 UP. Press N until Terminal Limit Utilities appears. Press S. Press N until Perform Terminal Tests appears. Press S.
3. With TERMINAL TEST/CMD: DN [N]-QUIT displayed, press S to display Terminal Test [S]-Run [N]-Quit. Press S to display Terminal Test/Cmd: DN [N]- displayed, use +/- buttons to select UP. Press S.
4. GOING TO TOP will be displayed. Set F5 down while traveling. When the car performs a controlled emergency slowdown, it will display UNT SW LOW OVERSPEED.
5. Set F5 up. Press + and N buttons to exit terminal tests. Return Delta High Speed to original setting.
6. Repeat test for down direction outer DNTS switch.

### Continued NTS/ETS Testing

If more than one set of virtual terminal switches are used, outer NTS and ETS switches can be prevented from tripping by setting them to unused. Then, for the switch to be tested, perform high and low overspeed tests as previously described. Note that D/UNTS1 switches should never be set to unused.

### ETS Testing

If only one set of NTS switches (NTS1) is used, ETS switches will be closest to the terminal landings.

1. NTS1 switches may not be set to unused, so set NTS1 switch speeds to contract speed to “move them out of the way” for ETS testing.
2. Complete ETS testing just as Delta High Speed for NTS switches. Once an overspeed occurs, the LCD will display UET SW OVERSPEED for top or DET SW OVERSPEED for bottom.
3. When overspeed occurs, the car will level into a floor and the latched fault ETS FAULT SHUTDOWN will appear. This fault must be reset using the Fault Reset button.
4. Be sure to return NTS1 switch speeds to their correct values when ETS testing is completed.

### ETSL Testing

If the job uses reduced stroke buffers, ETSL switches must be installed and adjusted. Please refer to “Reduced Stroke Buffers” on page 4-111. These switches are typically set at about 95% of the reduced stroke buffer speed rating.

## Electrical Governor Test

Verifies correct calibration of the electrical governor switch (typically about 110% of contract speed); proves the car will execute an emergency stop when the switch is activated. Car must run fast enough to trip the electrical governor switch, but not so fast as to trip the mechanical governor.

1. Verify no jumper between GOS1/GOS2.
2. Run the car to the top landing.
3. Set F3 > Controller System Menu > AUTOMATIC MODE FAULT BYPASS = BYPASS ON.
4. KEB/TorqMAX Only: Set LF.22 Gear Ratio to LF.25 x 2.
5. Set F7 Parameter 141 PROFILE SCALE to a value above electrical governor trip speed but less than mechanical trip speed (mechanical trip speed typically about 115% of Contract Speed).
6. Place a call to the bottom landing.
7. The car should accelerate and then perform an emergency stop
8. Place the car on Inspection.
9. Reset the electrical governor.
10. To reset the emergency brake: TC-MPI board, press/hold EB RST for 8 seconds.
11. Set F3 > Controller System Menu > AUTOMATIC MODE FAULT BYPASS = BYPASS OFF.
12. Return F7, 141, and (KEB/TorqMAX) drive parameters to their original settings.

### Ascending Car Overspeed Test

The mechanic must determine appropriate weight, if any, to be placed in the car for this test.

1. Bring the empty car to the bottom floor with car and hoistway doors closed and locked.
2. Observe car speed at F3 POSTN SPEED and stand by to engage brake if governor overspeed switch fails to open.
3. Use your preferred method to mechanically release the machine brake. The car will start to move up the hoistway.
4. When the governor overspeed switch opens, the emergency brake will engage, stop, and hold the car.
5. Reset the emergency brake: TC-MPI board, press/hold EB RST for 8 seconds.

### Safety Tests

This is a two part test. Car safety testing verifies proper operation of car safeties. The objective is to set the safeties causing the machine to break traction. The overspeed must be sufficient to cause the governor to trip mechanically and set the car safeties. The electrical governor switch must not prevent the car from reaching the mechanical trip speed and the safety operated switch (plank switch) must not open the safety string.

#### Car Safety Test

1. Run the car to the top landing.
2. Set F3 > Controller System Menu > AUTOMATIC MODE FAULT BYPASS = BYPASS ON.
3. KEB/TorqMAX Only: Set LF.22 Gear Ratio to LF.25 x 2.
4. Set F7 Parameter 141 PROFILE SCALE to 115% (mechanical tripping speed is typically about 115% of Contract Speed).
5. Bypass the Electrical Governor Switch by placing a jumper from GOS1 to GOS2.
6. Place a call to the bottom landing.
7. As the car over speeds:
  - The governor will trip
  - Safeties will set
  - The machine will break traction
  - Car will stop
8. Place on Inspection. Reset the governor.
9. Return F7 controller parameters (and KEB/TorqMAX drive) to their original values.
10. If necessary (unintended motion fault occurred), on the TC-MPI board, press and hold the EB RST button for 8 seconds.
11. Set F3 > Controller System Menu > AUTOMATIC MODE FAULT BYPASS = BYPASS OFF.
12. Remove the jumper between GOS1 and GOS2.
13. On the HC-CTL board, place a jumper between terminals SAFC and SAFH.
14. Run the car up on Inspection to release the safeties.
15. Remove the jumper between the CTL board terminals SAFC and SAFH.

### Counterweight Safety Test

The counterweight safety test verifies the operation of the counterweight safeties. The test is comparable to the car safety test but performed in the opposite direction. If the counterweight has a governor, remember to jumper it out.

1. Run the car to the bottom landing.
2. Set F3 > Controller System Menu > AUTOMATIC MODE FAULT BYPASS = BYPASS ON.
3. KEB/Torqmax only. Set LF.22 Gear Ratio to LF.25 x 2.
4. Set F7 Parameter 141 PROFILE SCALE to 115% (mechanical tripping speed is typically about 115% of Contract Speed).
5. Bypass the Electrical Governor Switch by placing a jumper between GOS1 and GOS2.
6. Place a call to the top landing.
7. As the counterweight over speeds
  - The governor will trip
  - Safeties will set
  - The machine will break traction
  - Car will stop
8. Place the car on Inspection. Reset the governor.
9. KEB/Torqmax only. Return drive parameters to their original values.
10. Return F7 controller parameters to their original values.
11. If an unintended motion fault was triggered, on the TC-MPI board, press and hold the EB RST button for 8 seconds.
12. Set F3 > Controller System Menu > AUTOMATIC MODE FAULT BYPASS = BYPASS OFF.
13. Remove the jumper between GOS1 and GOS2.
14. On the HC-CTL board, place a jumper between terminals SAFC and SAFH.
15. Run the car down on Inspection to release the counterweight safeties.
16. Remove the jumper between the CTL board terminals SAFC and SAFH.

### Emergency Brake Test - Unintended Motion, Rope Brake

This test verifies that moving the car away from a landing with both the car and Hoistway doors open (termed “Unintended motion” will cause the Emergency Brake (Rope Gripper) to be deployed and that such deployment will stop the elevator. This test demonstrates that the emergency brake will stop the car within 48” from floor level if the car drifts from the floor.

1. For safety, station a mechanic at the landing where the test is to be performed.
2. Bring the car to the landing away from the terminals and place on Independent service.
3. Load the car as required (100% or 125% of load). Place barricades to prevent entry.
4. Use a non-metallic object to press and hold contactors, BR and BRX (to allow the car to drift from the floor).
5. As the car moves away from the floor, observe that the emergency brake stops and holds the car within 48 inches (122 cm) of floor level.
6. To restore normal operation, verify doors are closed, place car on Inspection and press the EB RESET button on the TC-MPI board for a minimum of 8 seconds until the emergency brake resets.

When testing is complete, make sure that all appropriate data has been properly documented.

**Table 3.4 F7 Parameters**

#	Item	Min	Default	Max	Notes
1	Floor 1	-12.0 in	0.0 in	+12000.0 in	
2	Floor 2	-12.0 in	+120.0 in	+12000.0 in	
3	Floor 3	-12.0 in	+240.0 in	+12000.0 in	
4	Floor 4	-12.0 in	+360.0 in	+12000.0 in	
5	Floor 5	-12.0 in	+480.0 in	+12000.0 in	
6	Floor 6	-12.0 in	+600.0 in	+12000.0 in	
7	Floor 7	-12.0 in	+720.0 in	+12000.0 in	
8	Floor 8	-12.0 in	+840.0 in	+12000.0 in	
9	Floor 9	-12.0 in	+960.0 in	+12000.0 in	
10	Floor 10	-12.0 in	+1080.0 in	+12000.0 in	
11	Floor 11	-12.0 in	+1200.0 in	+12000.0 in	
12	Floor 12	-12.0 in	+1320.0 in	+12000.0 in	
13	Floor 13	-12.0 in	+1440.0 in	+12000.0 in	
14	Floor 14	-12.0 in	+1560.0 in	+12000.0 in	
15	Floor 15	-12.0 in	+1680.0 in	+12000.0 in	
16	Floor 16	-12.0 in	+1800.0 in	+12000.0 in	
17	Floor 17	-12.0 in	+1920.0 in	+12000.0 in	
18	Floor 18	-12.0 in	+2040.0 in	+12000.0 in	
19	Floor 19	-12.0 in	+2160.0 in	+12000.0 in	
20	Floor 20	-12.0 in	+2280.0 in	+12000.0 in	
21	Floor 21	-12.0 in	+2400.0 in	+12000.0 in	
22	Floor 22	-12.0 in	+2520.0 in	+12000.0 in	
23	Floor 23	-12.0 in	+2640.0 in	+12000.0 in	
24	Floor 24	-12.0 in	+2760.0 in	+12000.0 in	
25	Floor 25	-12.0 in	+2880.0 in	+12000.0 in	
26	Floor 26	-12.0 in	+3000.0 in	+12000.0 in	
27	Floor 27	-12.0 in	+3120.0 in	+12000.0 in	
28	Floor 28	-12.0 in	+3240.0 in	+12000.0 in	
29	Floor 29	-12.0 in	+3360.0 in	+12000.0 in	

**Table 3.4 F7 Parameters**

#	Item	Min	Default	Max	Notes
30	Floor 30	-12.0 in	+3480.0 in	+12000.0 in	
31	Floor 31	-12.0 in	+3600.0 in	+12000.0 in	
32	Floor 32	-12.0 in	+3720.0 in	+12000.0 in	
33	Floor 33	-12.0 in	+3840.0 in	+12000.0 in	
34	Floor 34	-12.0 in	+3960.0 in	+12000.0 in	
35	Floor 35	-12.0 in	+4080.0 in	+12000.0 in	
36	Floor 36	-12.0 in	+4200.0 in	+12000.0 in	
37	Floor 37	-12.0 in	+4320.0 in	+12000.0 in	
38	Floor 38	-12.0 in	+4440.0 in	+12000.0 in	
39	Floor 39	-12.0 in	+4560.0 in	+12000.0 in	
40	Floor 40	-12.0 in	+4680.0 in	+12000.0 in	
41	Floor 41	-12.0 in	+4800.0 in	+12000.0 in	
42	Floor 42	-12.0 in	+4920.0 in	+12000.0 in	
43	Floor 43	-12.0 in	+5040.0 in	+12000.0 in	
44	Floor 44	-12.0 in	+5160.0 in	+12000.0 in	
45	Floor 45	-12.0 in	+5280.0 in	+12000.0 in	
46	Floor 46	-12.0 in	+5400.0 in	+12000.0 in	
47	Floor 47	-12.0 in	+5520.0 in	+12000.0 in	
48	Floor 48	-12.0 in	+5640.0 in	+12000.0 in	
49	Floor 49	-12.0 in	+5760.0 in	+12000.0 in	
50	Floor 50	-12.0 in	+5880.0 in	+12000.0 in	
51	Floor 51	-12.0 in	+6000.0 in	+12000.0 in	
52	Floor 52	-12.0 in	+6120.0 in	+12000.0 in	
53	Floor 53	-12.0 in	+6240.0 in	+12000.0 in	
54	Floor 54	-12.0 in	+6360.0 in	+12000.0 in	
55	Floor 55	-12.0 in	+6480.0 in	+12000.0 in	
56	Floor 56	-12.0 in	+6600.0 in	+12000.0 in	
57	Floor 57	-12.0 in	+6600.0 in	+12000.0 in	
58	Floor 58	-12.0 in	+6720.0 in	+12000.0 in	
59	Floor 59	-12.0 in	+6840.0 in	+12000.0 in	
60	Floor 60	-12.0 in	+6960.0 in	+12000.0 in	
61	Floor 61	-12.0 in	+7080.0 in	+12000.0 in	
62	Floor 62	-12.0 in	+7200.0 in	+12000.0 in	
63	Floor 63	-12.0 in	+7320.0 in	+12000.0 in	
64	Floor 64	-12.0 in	+7440.0 in	+12000.0 in	
65	Bottom access distance	0.0 in	+120.0 in	+12000.0 in	
66	Top access distance	0.0 in	+120.0 in	+12000.0 in	
67	Counterweight position	0.0 in	+540.0 in	+12000.0 in	
68	Directional limit distance	0.0 in	+2.0 in	+1200.0 in	
69	U/DETS		VIRTUAL		UNUSED, VIRTUAL, PHYSICAL
70	U/DNT1		VIRTUAL		UNUSED, VIRTUAL, PHYSICAL
71	U/DNT2		UNUSED		UNUSED, VIRTUAL, PHYSICAL
72	U/DNT3		UNUSED		UNUSED, VIRTUAL, PHYSICAL
73	U/DNTS		UNUSED		UNUSED, VIRTUAL, PHYSICAL
74	U/DNT5		UNUSED		UNUSED, VIRTUAL, PHYSICAL



**Table 3.4 F7 Parameters**

#	Item	Min	Default	Max	Notes
75	UETS speed	0 fpm	+332 fpm	+900 fpm	
76	UETS distance	-1200.0 in	+48.0 in	+1200.0 in	
77	UETS delta distance	-120.0 in	+6.0 in	+120.0 in	
78	UETS delta speed	0 fpm	20 fpm	+900 fpm	
79	UNTS1 speed	0 fpm	0 fpm	+900 fpm	
80	UNTS1 distance	-1200.0 in	+104.5 in	+1200.0 in	
81	UNTS1 delta distance	-120.0 in	+6.0 in	+120.0 in	
82	UNTS1 delta low speed	0 fpm	10 fpm	+900 fpm	
83	UNTS1 delta high speed	0 fpm	20 fpm	+900 fpm	
84	UNTS2 speed	0 fpm	0 fpm	+900 fpm	
85	UNTS2 distance	-1200.0 in	0.0 in	+1200.0 in	
86	UNTS2 delta distance	-120.0 in	+6.0 in	+120.0 in	
87	UNTS2 delta low speed	0 fpm	10 fpm	+900 fpm	
88	UNTS2 delta high speed	0 fpm	20 fpm	+900 fpm	
89	UNTS3 speed	0 fpm	0 fpm	+900 fpm	
90	UNTS3 distance	-1200.0 in	0.0 in	+1200.0 in	
91	UNTS3 delta distance	-120.0 in	+6.0 in	+120.0 in	
92	UNTS3 delta low speed	0 fpm	10 fpm	+900 fpm	
93	UNTS3 delta high speed	0 fpm	20 fpm	+900 fpm	
94	UNTS4 speed	0 fpm	0 fpm	+900 fpm	
95	UNTS4 distance	-1200.0 in	0.0 in	+1200.0 in	
96	UNTS4 delta distance	-120.0 in	+6.0 in	+120.0 in	
97	UNTS4 delta low speed	0 fpm	10 fpm	+900 fpm	
98	UNTS4 delta high speed	0 fpm	20 fpm	+900 fpm	
99	UNTS5 speed	0 fpm	0 fpm	+900 fpm	
100	UNTS5 distance	-1200.0 in	0.0 in	+1200.0 in	
101	UNTS5 delta distance	-120.0 in	+6.0 in	+120.0 in	
102	UNTS5 delta low speed	0 fpm	10 fpm	+900 fpm	
103	UNTS5 delta high speed	0 fpm	20 fpm	+900 fpm	
104	DETS speed	0 fpm	+332 fpm	+900 fpm	
105	DETS distance	-1200.0 in	+48.0 in	+1200.0 in	
106	DETS delta distance	-120.0 in	+6.0 in	+120.0 in	
107	DETS delta speed	0 fpm	20 fpm	+900 fpm	
108	DNTS1 speed	0 fpm	0 fpm	+900 fpm	
109	DNTS1 distance	-1200.0 in	+104.5 in	+1200.0 in	
110	DNTS1 delta distance	-120.0 in	+6.0 in	+120.0 in	
111	DNTS1 delta low speed	0 fpm	0 fpm	+900 fpm	
112	DNTS1 delta high speed	0 fpm	0 fpm	+900 fpm	
113	DNTS2 speed	0 fpm	0 fpm	+900 fpm	
114	DNTS2 distance	-1200.0 in	0.0 in	+1200.0 in	
115	DNTS2 delta distance	-120.0 in	+6.0 in	+120.0 in	

**Table 3.4 F7 Parameters**

#	Item	Min	Default	Max	Notes
116	DNTS2 delta low speed	0 fpm	10 fpm	+900 fpm	
117	DNTS2 delta high speed	0 fpm	20 fpm	+900 fpm	
118	DNTS3 speed	0 fpm	0 fpm	+900 fpm	
119	DNTS3 distance	-1200.0 in	0.0 in	+1200.0 in	
120	DNTS3 delta distance	-120.0 in	+6.0 in	+120.0 in	
121	DNTS3 delta low speed	0 fpm	10 fpm	+900 fpm	
122	DNTS3 delta high speed	0 fpm	20 fpm	+900 fpm	
123	DNTS4 speed	0 fpm	0 fpm	+900 fpm	
124	DNTS4 distance	-1200.0 in	0.0 in	+1200.0 in	
125	DNTS4 delta distance	-120.0 in	+6.0 in	+120.0 in	
126	DNTS4 delta low speed	0 fpm	10 fpm	+900 fpm	
127	DNTS4 delta high speed	0 fpm	20 fpm	+900 fpm	
128	DNTS5 speed	0 fpm	0 fpm	+900 fpm	
129	DNTS5 distance	-1200.0 in	0.0 in	+1200.0 in	
130	DNTS5 delta distance	-120.0 in	+6.0 in	+120.0 in	
131	DNTS5 delta low speed	0 fpm	10 fpm	+900 fpm	
132	DNTS5 delta high speed	0 fpm	20 fpm	+900 fpm	
133	Brake pick delay	0 ms	0 ms	+10000 ms	
134	Speed pick delay	0 ms	+500 ms	+10000 ms	
135	Brake hold delay	0 ms	+2000 ms	+10000 ms	
136	Brake drop delay	0 ms	+500 ms	+2000 ms	
138	Drive disable delay	0 ms	+1250 ms	+2000 ms	
139	Speed hysteresis delay	0 ms	+1000 ms	+10000 ms	
140	Profile advance	0 ms	+100 ms	+1000 ms	
141	Profile scale	0%	100%	+1000%	
142	Standard slew slope	0.00 ft/s <sup>2</sup>	+0.5 ft/s <sup>2</sup>	+50.00 ft/s <sup>2</sup>	
143	Danger slew slope	0.00 ft/s <sup>2</sup>	+10.00 ft/s <sup>2</sup>	+50.00 ft/s <sup>2</sup>	
144	Slew filter	+0.1 Hz	+20.0 Hz	+20 Hz	
145	Contract over-speed	0 fpm	+375 fpm	+1000 fpm	
146	Inspection over-speed	0 fpm	+125 fpm	+148 fpm	
147	Leveling over-speed	0 fpm	+125 fpm	148 fpm	
148	Hoist-motor speed	+1.0 rpm	+1165.0 rpm	+9999.9 rpm	
149	Contract speed	+25 fpm	+350 fpm	+800 fpm	
150	High speed	+25 fpm	+350 fpm	+800 fpm	
151	Intermediate speed	+25 fpm	+300 fpm	+800 fpm	SPI1 terminal (TC-MPI board)
152	Earthquake speed	+25 fpm	+150 fpm	+150 fpm	
153	Auxiliary speed	+25 fpm	+250 fpm	+800 fpm	SPI2 terminal (TC-MPI board)
154	Backup power speed	+25 fpm	+200 fpm	+800 fpm	
155	Inspection speed (normal)	0 fpm	+50 fpm	+148 fpm	

Table 3.4 F7 Parameters

#	Item	Min	Default	Max	Notes
156	Inspection speed (reduced)	0 fpm	+25 fpm	+148 fpm	
157	Correction speed	0 fpm	+75 fpm	+250 fpm	
158	Leveling speed	0 fpm	+4 fpm	+25 fpm	
159	Re-leveling speed	0 fpm	+6 fpm	+25 fpm	
160	Leveling distance	0.0 in	+1.0 in	+9.0 in	
161	Re-leveling distance	0.0 in	+1.0 in	+9.0 in	
162	Proximity distance	0.0 in	+18.0 in	+120.0 in	
163	Leveling dead zone distance	0.0 in	+0.5 in	+3.0 in	
165	Standard start jerk	+0.10 ft/s <sup>3</sup>	+4.00 ft/s <sup>3</sup>	+15.00 ft/s <sup>3</sup>	
166	Standard roll jerk	+0.10 ft/s <sup>3</sup>	+4.00 ft/s <sup>3</sup>	+15.00 ft/s <sup>3</sup>	
167	Standard stop jerk	+0.10 ft/s <sup>3</sup>	+2.00 ft/s <sup>3</sup>	+15.00 ft/s <sup>3</sup>	
168	Standard acceleration	0.00 ft/s <sup>2</sup>	+2.00 ft/s <sup>2</sup>	+10.0 ft/s <sup>2</sup>	
169	Standard deceleration	0.00 ft/s <sup>2</sup>	+2.00 ft/s <sup>2</sup>	+10.0 ft/s <sup>2</sup>	
170	Manual start jerk	+0.10 ft/s <sup>3</sup>	+1.00 ft/s <sup>3</sup>	+15.00 ft/s <sup>3</sup>	
171	Manual roll jerk	+0.10 ft/s <sup>3</sup>	+1.00 ft/s <sup>3</sup>	+15.00 ft/s <sup>3</sup>	
172	Manual stop jerk	+0.10 ft/s <sup>3</sup>	+1.00 ft/s <sup>3</sup>	+15.00 ft/s <sup>3</sup>	
173	Manual acceleration	0.00 ft/s <sup>2</sup>	+0.50 ft/s <sup>2</sup>	+10.0 ft/s <sup>2</sup>	
174	Manual deceleration	0.00 ft/s <sup>2</sup>	+0.50 ft/s <sup>2</sup>	+10.0 ft/s <sup>2</sup>	
175	Danger start jerk	+0.10 ft/s <sup>3</sup>	+25.00 ft/s <sup>3</sup>	+50.00 ft/s <sup>3</sup>	
176	Danger roll jerk	+0.10 ft/s <sup>3</sup>	+25.00 ft/s <sup>3</sup>	+50.00 ft/s <sup>3</sup>	
177	Danger stop jerk	+0.10 ft/s <sup>3</sup>	+25.00 ft/s <sup>3</sup>	+50.00 ft/s <sup>3</sup>	
178	Danger deceleration	0.00 ft/s <sup>2</sup>	6.00 ft/s <sup>2</sup>	+15.00 ft/s <sup>2</sup>	
179	Alternate start jerk	+0.10 ft/s <sup>3</sup>	+2.00 ft/s <sup>3</sup>	+15.00 ft/s <sup>3</sup>	
180	Alternate roll jerk	+0.10 ft/s <sup>3</sup>	+2.00 ft/s <sup>3</sup>	+15.00 ft/s <sup>3</sup>	
181	Alternate stop jerk	+0.10 ft/s <sup>3</sup>	+2.00 ft/s <sup>3</sup>	+15.00 ft/s <sup>3</sup>	
182	Alternate acceleration	0.00 ft/s <sup>2</sup>	+1.50 ft/s <sup>2</sup>	+10.0 ft/s <sup>2</sup>	
183	Alternate deceleration	0.00 ft/s <sup>2</sup>	+1.50 ft/s <sup>2</sup>	+10.0 ft/s <sup>2</sup>	
184	Drive type		KEB F5-GRD50		KEB F5-GRD49 (geared) or KEB F5-GLS49 (gearless) for ver 1.61 drive software, KEB F5-GRD50 (geared) or KEB F5-GLS50 (gearless) for ver 1.71 drive software, YASKAWA, MAG QUATTRO, MAG HPV, MAG DSD
185	Brake type		DISCRETE		DISCRETE, ONE MODULE, TWO MODULES
186	Emergency brake		ROPE GRIPPER		DISABLED, ROPE GRIPPER, SHEAVE BRAKE, MACHINE BRAKE

**Table 3.4 F7 Parameters**

#	Item	Min	Default	Max	Notes
187	Reduced inspect speed		OFF		OFF, ETS, NTS1, NTS2, NTS3, NTS4, NTS5
188	Unintended motion		LEVEL ZONE		LEVEL ZONE, DOOR ZONE
189	Following error	0%	+25%	+1000%	
190	Sheave Brake Idle Delay	0S	30S	3600S	
191	Landing System		Elgo 160		Elgo-160, Elgo-240, LS-EDGE
192	Speed Drop Delay				Magnetek drives only. Time in milliseconds during which the drive should continue to exert motor control after the car has achieved the floor and before the brake has dropped.
193	Profile Compensation				Dynamic: Variable, controller determined compensation for drive lag based on entry in parameter 140, Profile Advance. Fixed: Fixed compensation for drive lag using the parameter 140, Profile Advance setting.
194	Normal Brake Pick Voltage	0V		300V	
195	Normal Brake Hold Voltage	0V		300V	
196	Normal Brake Relevel Voltage	0V		300V	
197	Normal Brake Lift Rate	0%		100%	
198	Normal Brake Drop Rate	0%		100%	
199	Emergency Brake Type				Module or Discrete
200	Emergency Brake Pick Voltage	0V		300V	
201	Emergency Brake Hold Voltage	0V		300V	
202	Directional Limit Type		Virtual		Virtual or Physical

## Emergency or Standby Power Operation

Two emergency power tests are described here. The first is for a car equipped with the TAPS (Traction Auxiliary Power Supply) from MCE. The second is for a car equipped with backup generator power.



### Note

When performing emergency power related testing, ensure that the mPAC hand-held programming unit, if used, is not connected.

## Traction Auxiliary Power Supply Test

The MCE Traction Auxiliary Power Supply, TAPS, monitors the commercial electrical power provided to an AC traction elevator controller. If commercial power fails, the auxiliary power supply provides single phase backup power, directs the controller to move the car safely to a landing, and provides power to open the elevator doors. If the elevator controller chooses a direction that draws power beyond a customer-preset level, the system will direct the controller to pause the car, then reverse direction to the nearest landing, again providing power to open the doors and allow passengers to exit. The TAPS unit will then disconnect power to the elevator controller after a customer defined time period or when an output from the controller tells it that the cycle is complete. When commercial power is restored, TAPS will direct commercial power to the elevator controller and automatically recharge the backup batteries for future use.

Check the MCE drawings to verify that the car is properly connected to a TAPS unit. Additionally verify that the TAPS unit is properly charged and is displaying no fault conditions.

**Mainline Disconnect Verification** This verifies that the fourth pole of the main line disconnect or micro switch is functional when power is intentionally shut off at the main line disconnect.

1. Verify that TAPS BS1 and BS2 are connected to the fourth pole of the main line disconnect.
2. Set the AC/TAPS DISCONNECT switch to the ON position.
3. Shut off power at the main line disconnect.
4. Verify that the car is not energized and remains stopped.

## TAPS and Controller Operation Verification

1. Ensure the main line disconnect is in the ON position.
2. Ensure the AC/TAPS DISCONNECT switch is in the ON position.
3. Ensure the TAPS BYPASS switch is in the NORMAL position.
4. Verify the NORMAL POWER indicator is on.
5. With empty car, move the elevator on inspection slightly above the leveling zone of the floor with the longest floor distance moving in the up direction.
6. Push and hold the test button until TAPS is in backup power mode. Verify the BACKUP POWER indicator is on.
7. Quickly put the elevator back to normal operation.
8. The elevator should begin to move in the up direction until it reaches the floor above. Once the elevator reaches the floor, it shall cycle the door.

9. If TAPS shuts down before the elevator completes the rescue operation due to the timer set in parameter F1-1 “Backup Power Run Time,” extend the timer accordingly and perform the test again.
10. If TAPS shuts down before the elevator completes the rescue operation due to battery voltage drop below F1-5 (error code E-04), let the TAPS charge for 8 hours before performing this test again.
11. If input P3 “Rescue Operation Complete” is used, TAPS shall shut down once the rescue operation is complete and input P3 is energized. This will immediately cancel the parameter F1-1 “Backup Power Run Time.” If the command is not issued to the TAPS unit, please check wiring and controller output.
12. If input P2 “Restart Backup Power Operation” is used, verify by pushing the DOB button in the COP to validate proper wiring and operation. This can be done once TAPS has been shut down by either P3 input or parameter F1-1 “Backup Run Time” having elapsed. TAPS shall then restart when the DOB is pressed and will operate until either P3 is activated or parameter F1-1 has expired.
13. If input P1 “Remote Backup Power Operation” is used, verify correct operation by triggering this input from the appropriate controller output or the source it is wired to. To do this, TAPS shall be on commercial power operation and “Normal Power” indicator shall be lighted. When the P1 input is triggered and held for the duration defined by F1-9 “Commercial Power Loss Detection” (factory default is 2 seconds), TAPS shall proceed to “BACK UP” power operation and indicator BACKUP POWER shall light. TAPS shall then operate until cancelled by either input P3 “Rescue operation Complete” or by parameter F1-1 “Backup Power Run Time” having elapsed. Note that shut down may also be caused by drained/discharged batteries, dead batteries, or an inoperative UPS unit.

### Backup Generator Power Test

The controller will put the elevator into Emergency Power Operation when the controller receives the Emergency Power Input (EPI) signal. During Phase 1 of Emergency Power Operation, the car will be moved to the emergency power return floor. For groups or duplex installations, each car will be moved to the emergency power return floor one at a time.

During Phase 2 of Emergency Power Operation, if the car Emergency Power Run (EPRUN) input is activated, the car will run normally. Otherwise, the car will remain at the emergency power return floor and will not respond to calls.

For a simplex controller, the car EPRUN input is sometimes connected to a switch so that the input can be turned ON and OFF. For a duplex or groups, each car EPRUN input may be connected to a Run Selection switch. The position of this switch determines which car will run during Phase 2 of Emergency Power Operation.

Often, there is an AUTO position on the Run Selection switch connected to the AUTO inputs on controllers in a group or duplex installation. If the AUTO input is activated, one car will be automatically selected to run during Phase 2 of Emergency Power Operation. For example: If one car happens to be out of service when the operation begins, another car will be automatically selected to run.

Check the MCE drawings to verify that the car is properly connected to the emergency generator and that emergency power (F1, Extra Features Menu) is set up appropriately. A typical generator connection is shown below.

Figure 3.4 Typical Emergency Generator Connection

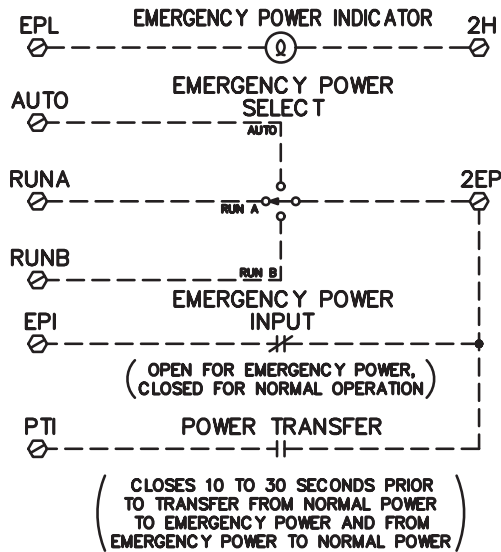

3

1. Disconnect power from the controller.
2. When the emergency generator comes on line, the EPI input to the controller should be activated.
3. The car will recall to the assigned floor.
4. If the EPRUN input (not shown), the designated car will respond to hall and car calls. Otherwise, the car will remain at the recall floor.
5. Restore normal power to the controller. If running, the designated car will stop, wait until normal power is fully established, then resume normal operation.

### Final Adjustment

Once you are satisfied that the car is operating accurately and safely, you will want to ride the car to verify the comfort of the ride and proper operation from a passenger perspective.

1. Place the car on Independent Service so that it will not respond to hall calls.
2. Verify IND indicator on HC-CTL Control board is lighted.
3. Verify the TEST switch is in the NORMAL position.
4. Verify the LCD displays INDEPENDENT.

While riding the car:

- Verify proper door operation including re-opening, nudging, safe edge, photo eye, and door open and close button operation.
- Verify proper floor leveling at all landings.

Place the car on Normal operation. Verify:

- Hall call operation
- PIs and gongs
- Fire return and in-car operation for main and alternate landings
- Alternate riser operation
- Other options as required per job
- Normal and Inspection Mode Fault Bypasses to OFF
  - F3 function switch UP
  - System Mode/Controller System Menu
  - Automatic mode fault bypass: Bypass OFF
  - Inspection mode fault bypass: Bypass OFF
- Make adjustments as required.





**Motion Control Engineering®**

A Kinetek Company®

*User Interface*

## In this Section

The default user interface to the Motion 4000 Traction Control is the LCD and keypad on the HC-MPU board. A hand-held user interface that functions like the LCD and keypad may also be provided. The hand-held user interface provides access when plugged into any CAN Bus connector in the system. This section describes user interface functionality:

- HC-MPU Main Processor: Board indicators, switches, buttons, connectors and display
- Access Security: Optional password protection system (see [page 4-5](#)).

Adjustments to system settings are made using switches and buttons on the MPU board or on the hand-held control. There are eight different “functions,” each of which accesses different groups of settings. On the MPU board, you access a functional area by moving one of eight “function” switches to the UP position. On the hand-held, you press a “function” button.

- With no function selected: Diagnostic messages are displayed. See [page 4-6](#).
- F1 — Program Mode:
  - Basic Features Menu (see [page 4-13](#))
  - Fire Service Menu (see [page 4-16](#))
  - Door Operation Menu (see [page 4-18](#))
  - Timer Menu (see [page 4-23](#))
  - Gongs/Lanterns Menu (see [page 4-25](#))
  - Spare Inputs Menu (see [page 4-26](#))
  - Spare Outputs Menu (see [page 4-35](#))
  - Extra Features Menu (see [page 4-42](#))
  - Additional Car Options (see [page 4-49](#))

- F2 — External Memory Mode:
  - View data stored in external memory. See [page 4-53](#).
- F3 — System Mode:
  - Building security. See [Building Security Menu on page 4-53](#).
  - Controller system (fault bypass, data trap). See [Controller System Menu on page 4-55](#).
  - Passcode request (See [Passcode Request Menu on page 4-56](#).)
  - Load weigher thresholds (See [Load Weigher Thresholds on page 4-57](#).)
  - Analog load weigher learn
  - Controller System Menu (real time speed/position [Additional Car Options on page 4-49](#))
- F4 — Messages and Floor Labels ([F4: Messages and Floor Labels on page 4-60](#))
- F5 — Controller Utilities Menu: Front and rear car call entry, date/time settings, motion diagnostics. (See [F5 Menus on page 4-61](#).)
  - Monitoring and Reporting ([Please refer to “Monitoring and Reporting Menu” on page 4-92](#)).
  - Learning Terminal switches ([Please refer to “Terminal Limit Utilities Menu” on page 4-95](#)).
- F6 — Hoistway learn operation ([Please refer to “F6: Hoistway Learn Operations” on page 4-97](#).)
  - Floors
  - Counterweight position
- F7 — Parameters adjust (download). [Please refer to “F7: Parameters Adjust” on page 4-100](#).
- F8 — Software version ([Please refer to “F8: Software Revision” on page 4-124](#).)
- F1 and F8 — Board software versions ([Please refer to “F1 & F8: Board Software Versions” on page 4-125](#).)

# The HC-MPU Main Processor Unit

Figure 4.1 HC-MPU Main Processor Unit Board

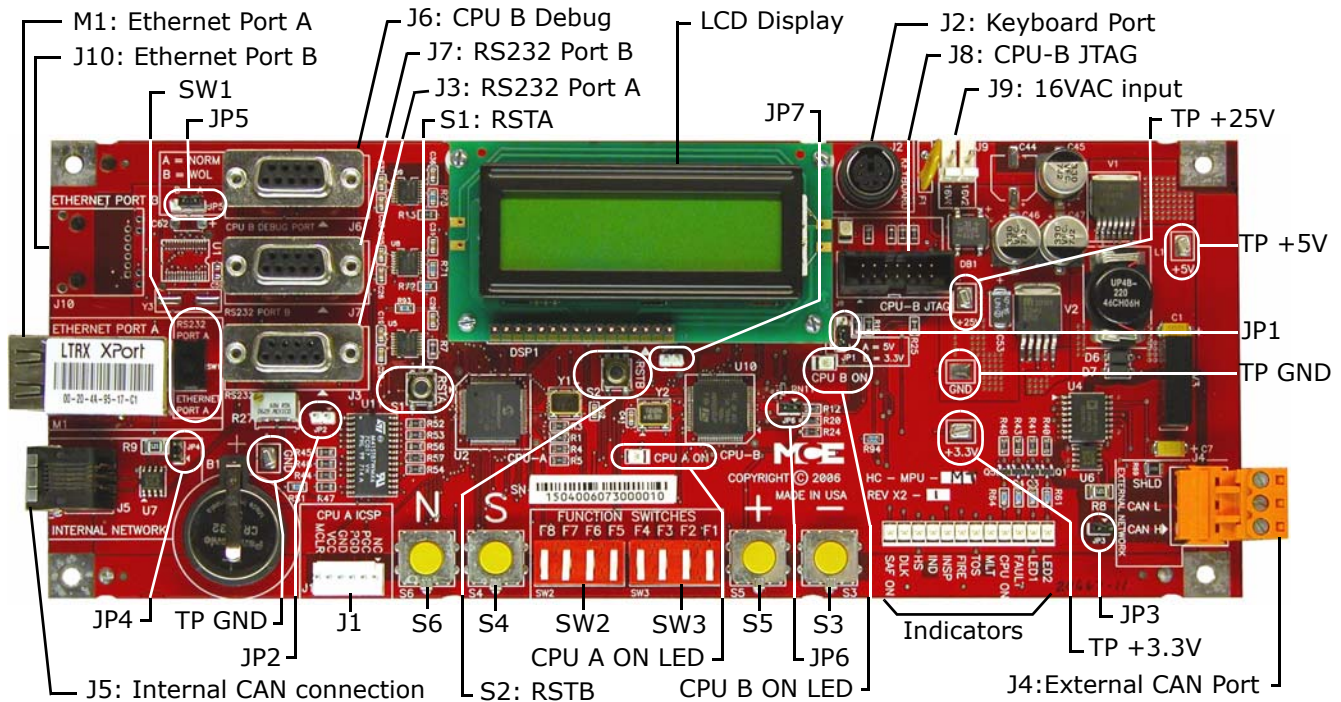

4

The kind of information displayed by the LCD depends on the settings of function switches F1 - F8:

- All switches down: Diagnostics mode - scrolling status message, car position, CPU internal memory content.
- Program mode - F1 switch up, others down. Parameter entry. Must be on Inspection.
- External Memory (RAM) - F2 switch up, others down. Review of RAM contents.
- System mode - F3 switch up, others down. Parameter entry for security, load weigher, and other system level functions. System does not have to be in Inspection mode.
- Serial Fixtures - F4 switch up, others down.
- Date/Time, event log, motion diagnostics, monitoring - F5 switch up, others down.
- ELGO Positioning system learn operation - F6 switch up, others down.
- Motion parameter Adjust - F7 up, others down. Traction parameters.
- Status - F8 switch up, others down. Display software version, floor eligibility, load as a percentage of full load.
- Board software versions - F1 and F8 up, others down. Press N to cycle through software version for each board in the system.

**Table 4.1 HC-MPU Board Switches**

Switches	Description
S1	RSTA: Reset CPU A
S2	RSTB: Reset CPU B
S3	"-" minus push button - decrement setting
S4	"S" push button - select
S5	"+" plus push button - increment setting
S6	"N" push button - next
SW1	Port Selection: RS232 Port A / Ethernet Port A
SW2	DIP Function switches F5 through F8
SW3	DIP Function switches F1 though F4

**Table 4.2 HC-MPU Board Indicators**

Indicators	Description
CPU A ON	CPU A is executing its program
CPU B ON	CPU B is executing its program
LED2	Reserved
LED1	Reserved
FAULT	A fault has been detected.
CPU ON	All processors are fully functional.
MLT	Motor/Valve Limit Timer: The motor/valve limit timer has elapsed.
TOS	Timed Out of Service: The TOS timer has elapsed and the car is out of service.
FIRE	Fire Service: The car is on fire service operation.
INSP	Inspection: The car is on inspection operation.
IND	Independent Service: The car is on independent service.
HS	High Speed: The car is running at high speed.
DLK	Doors Locked: The door lock contacts are made.
SAF ON	Safety On: The safety circuit is made.

- **RSTA - RSTB: Reset.** If the elevator is running when reset, the controller will drop the safety relay and bring the elevator to an immediate stop. The elevator will then go to the next landing, self-check, and resume service if warranted. Existing calls are lost if the computer is reset.
- **N, S, +, - Push Buttons: Parameter review and entry.** Access and function depend on the positions of the Function switches. Generally:
  - **N = Next.** Moves the cursor.
  - **S = Select or Save.**
  - **+/-: Increment/Decrement.**

## Access Security

Access security is an option. When access security is active, you are required to enter a password before parameters can be adjusted.

### Password

Program mode and System mode may be secured by an 8-digit, alpha-numeric code. If this is the case, when either mode is selected using the Function switches, the LCD will show:

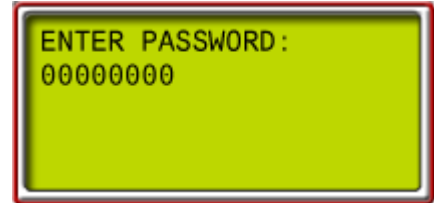

To enter a password:

- N: to select a digit
- +: to increment value
- -: to decrement value
- S: Enter (check against valid password)

Once a valid code is entered, access is granted. The password will not have to be re-entered until the password timer expires.

#### Note

If Passcode Request appears on the LCD, a passcode is required in order to run the elevator on any mode of operation other than Inspection. See [Passcode Request Menu](#) for more information. [Please refer to "Passcode Request Menu" on page 4-56.](#)

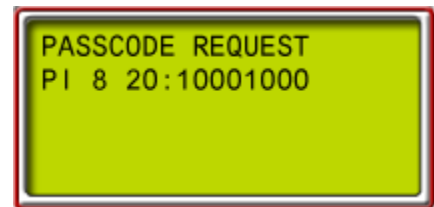

## Setting Parameters To Default Values

There are occasions when it is necessary to reset system parameters to default values:

- MC-MPU software is changed.
- RAM memory is corrupted (lightning strikes can sometimes cause this)

To reset to default values:

1. Place the car on Machine Room Inspection.
2. Place function switches **F1, 3, 5, and 7** in the **Up** position.
3. Press all four push buttons (**N, S, +, -**) at the same time.

After resetting parameters to their defaults, you will need to set up system parameters again.

## Diagnostic Mode

With all Function switches down, Diagnostic Mode is active. The LCD displays status, position, an internal memory register address and its contents (flags). This mode allows you to select a memory register and view its contents. Memory contents can tell you the exact state of controller inputs and outputs, which is very valuable in troubleshooting.

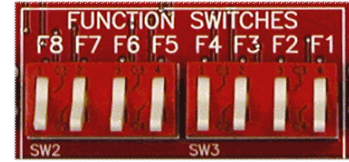

1. Select the address to view. (See following two tables.)
  - Press N to select an address digit (selected digits blink)
  - Press + or - to change the blinking digit
2. Press S to select the entered address when ready to view contents (or wait about 20 seconds and the selection will take effect by itself).

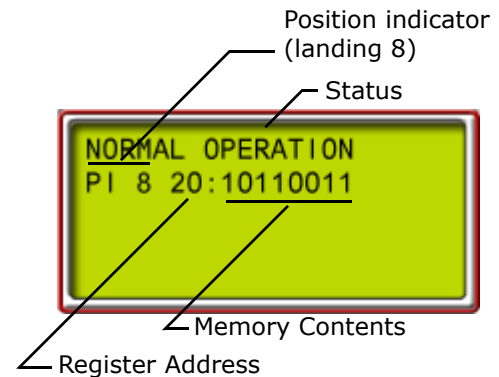

## LCD Format

- Control Configuration: D, S, or blank.
  - S (slave): Hall call assignments made by group or other controller.
  - D (dispatcher): This controller is acting as a dispatcher. It is responsible for assigning hall calls to itself and to a second controller if this is a Duplex installation.
  - Blank: Simplex operation or, if part of a group or duplex, communication has not been established with controller or group.
- Status / Error Message: The top line is elevator status or an error message. Messages are scrolled if longer than the space available. There is a status message for each special operation (e.g., Fire Service). There are also messages for error conditions (e.g., open safety string). [Please refer to “Status and Error Messages” on page 5-2](#) for a list of messages including a description and troubleshooting suggestions.
- PI “nn”: Current elevator position relative to the bottom floor. 1 denotes the lowest landing served.
- Computer Internal Memory: Register address and contents. Each of the 8 data digits (flags) corresponds to a particular elevator signal or condition. Each digit is either 1 or 0. A 1 indicates the signal or condition is ON and 0 indicates it is OFF.

Duplex Configuration:  
 D = Dispatcher  
 S = Slave  
 Blank = Simplex Operation

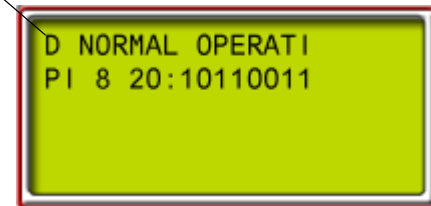

The Computer Internal Memory Chart (Table 4.3 on page 4-7) shows the meaning of data at different addresses. For example, the internal memory display might look like this:

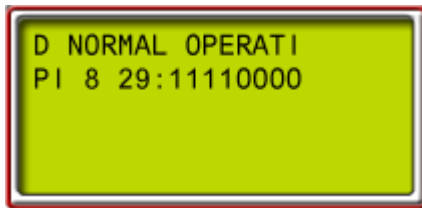

At address 29; the data is 11110000. To figure out what this means, match up the data digits with row 29 of the Computer Internal Memory Chart table:

Display Data:     1     1     1     1     0     0     0     0  
 Row 29:         DNDO LD   DPD   DDP   UPDO LU    UPD   UDP

DNDO, LD, DPD and DDP signals are ON; UPDO, LU, UPD and UDP signals are OFF.

**Table 4.3 Computer Internal Memory Chart**

FLAGS AND VARIABLES								
ADD	8	7	6	5	4	3	2	1
10:	DOLMR	PHER	DZR	DOLR	DBCR	DOBR	GEUR	GEDR
11:	TFAR	DCR	UCR	CCR	NDSR	FDCR	DHOR	DOIR
12:	DCFR	DCPR	DOFR	LOTR	GHTR	HCTR	CCTR	SDTR
13:	DOCR	SER	DCLCR	CSBR	DCCR	NUDGR	NDGBPSR	DSHTR
20:	DOLM	PHE	DZ	DOL	DBC	DOB	GEU	GED
21:	TFA	DC	UC	CC	NDS	FDC	DHO	DOI
22:	DCF	DCP	DOF	LOT	GHT	HCT	CCT	SDT
23:	DOC	SE	DCLC	CSB	DCC	NUDG	NDGBPS	DSHT
24:	INT	FRA	FCS	FRS	DNS	UPS	STD/R0	STU/R1
25:	SCE	FCCC	FCHLD	HLI	LEF	HDLYE	FWI	PIC
26:	LFP	UFP	NYDS	CCH	DIN	DPR	GTDE	GTUE
27:	HD	FCOFF	DHLD	IND	IN	DLKS	DELSIM	YSIM
28:	LLW	DLK	DDF	REL	ISR	INCF	REAR	LLI
29:	DNDO	LD	DPD	DDP	UPDO	LU	UPD	UDP
2A:	DMD	DCB	UCB	CCB	DMU	DCA	UCA	CCA
2B:	TOS	MLT		MGR	H	HSEL	DSH	RUN
2C:	DZP	STC	SAF	HCR	HCDX	CCD	ISV	ISRT
2D:	TEMPB	UFQ	DZORDZ	FCSM	FRM	FRSS	FRAS	FRC
2E:	SD	SDA	DSD	BFD	SU	SUA	USD	TFD
2F:	FRBYP	FRON	HYD1_TRC0	ECC	CD	ECRN	EPR	PFG
30:	R4	ISTD/R2	ISTU/R3	FREE	DEADZ	DHLDI	PH1	NDGF
31:	CTLDOT	CTLF	CTL	ALV	EPSTP	AUTO	EPRUN	EPI
33:	API	SAB	TEST	DHENDR	DHEND	CTST	HOSPH2	HOSP
38:	HML	SLV	CCC	CNFG	DLI	DLW	LWCE	HLW
42:	COMMUNICATION TIME-OUT ERROR COUNT							
43:	COMMUNICATION CHECKSUM ERROR COUNT							

## Troubleshooting Example

Examining the computer memory (as in the example above) is a useful step in troubleshooting. It is possible to find out if the controller is receiving input signals correctly and if it is sending proper output signals. It is also possible to look up each of the computer output and input signals shown in the Job Prints.

The following example explains how to use [Table 4.3 on page 4-7](#) and [Table 4.4 on page 4-9](#) to check a signal in internal memory.

- Problem: the photo eye will not cause the doors to reopen.
  1. Look at [Table 4.4 on page 4-9](#). Find the abbreviation or mnemonic for Photo Eye input.
    - The table shows that the mnemonic for Photo Eye input is PHE and provides an Address (Add) and Position (1 - 8).
    - This information shows where to look for the signal in [Table 4.3 on page 4-7](#) and on the computer display.

[Table 4.3 on page 4-7](#) shows that the address of PHE is 20 and the position is 7.

2. Notice in the table that PHE is indeed in position 7 on row 20.
3. Now that the address and position have been determined, look up the PHE signal on the computer.
  - First, change the address on the display to address 20.
  - Then, look at data bit number 7 (from the right), which is underlined in the graphic:

This digit represents the computer interpretation of the PHE signal. If the digit is 1, the computer thinks that the PHE signal is ON. If the digit is 0 (as shown), the computer thinks that the PHE signal is OFF.

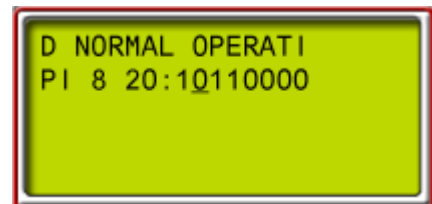

This information can be used to find the source of the problem. The diagnostic display will show that the PHE input is ON when an obstruction is present which should interrupt the photo eye beam. If this is the case, checking the voltage present on the PHE terminal will show if the problem is inside or outside the controller.



Table 4.4 Alphabetized Flags, Definitions, and Locations

FLAG	Definition	Add	Pos	FLAG	Definition	Add	Pos
ALV	Other car alive output	31	5	FRS	Fire phase 1 input	24	5
API	Alternate Parking Input	33	8	FRSS	Fire phase 1 flag	2D	3
AUTO	Emergency power auto output	31	3	FWI	Fire warning indicator output	25	2
BFD	Bottom floor demand flag	2E	5	GED	Gong enable down output	20	1
CC	Car call flag	21	5	GEDR	Gong enable down output rear	10	1
CCA	Car call above flag	2A	1	GEU	Gong enable up output	20	2
CCB	Car call below flag	2A	5	GEUR	Gong enable up output rear	10	2
CCC	Car call cancel input	38	6	GHT	Gong hold timer flag	22	4
CCD	Car call disconnect flag	2C	3	GHTR	Gong hold timer flag rear	12	4
CCH	Car call hold	26	5	GTDE	Gong timer down enable	26	2
CCR	Car call flag rear	11	5	GTUE	Gong timer up enable	26	1
CCT	Car call time flag	22	2	H	High speed output	2B	4
CCTR	Car call time flag rear	12	2	HCDX	Hall call disconnect flag	2C	4
CD	Car done flag	2F	4	HCR	Hall call reject flag	2C	5
CNFG	Configuration error flag	38	5	HCT	Hall call door time flag	22	3
CSB	Car stop switch bypass	23	5	HCTR	Hall call door time flag rear	12	3
CSBR	Car stop switch bypass rear	13	5	HD	High speed delay flag	27	8
CTL	Car to lobby input	31	6	HDLYE	High speed delay elapsed flag	25	3
CTLDOT	Car to lobby door open timer	31	8	HLI	Heavy load input	25	5
CTLF	Car to lobby function	31	7	HLW	Heavy load weigher flag	38	1
CTST	Capture for test input	33	3	HML	Home landing input	38	8
DBC	Door close button input	20	4	HOSP	In car hospital emergency input flag	33	1
DBCR	Door close button rear	10	4	HOSPH2	Hospital emergency phase 2 flag	33	2
DC	Down call flag	21	7	HSEL	Hospital service select flag	2B	3
DCA	Down call above flag	2A	3	HYD1-TR0	Hydro/Traction flag	2F	6
DCB	Down call below flag	2A	7	IN	Inspection or access input	27	4
DCC	Door close complete flag	23	4	INCF	Ind. service car call cancel flag	28	3
DCCR	Door close complete flag rear	13	4	IND	Independent service input	27	5
DCF	Door close function output	22	8	INT	Intermediate speed input	24	8
DCFR	Door close function output rear	12	8	ISR	In service and ready	28	4
DCLC	Door close contact input	23	6	ISRT	In service truly flag	2C	1
DCLCR	Door close contact input rear	13	6	ISV	In service flag	2C	2
DCP	Door close power output	22	7	LD	Level down input	29	7
DCPR	Door close power output rear	12	7	LEF	Leveling encounter flag	25	4
DCR	Down call flag rear	11	7	LFP	Lower parking floor flag	26	8
DDF	Double ding function flag	28	6	LLI	Light load input	28	1
DDP	Down direction preference flag	29	5	LLW	Light load weighing funct. input flag	28	8
DEADZ	Dead zone flag	30	4	LOT	Lobby door time	22	5
DELSIM	Delta simulation bit	27	2	LOTR	Lobby door time rear	12	5
DHEND	Door hold end	33	4	LU	Level up input	29	3
DHENDR	Door hold end rear	33	5	LWCE	Load weighing change enable flag	38	2
DHLD	Door hold input flag	27	6	MGR	Motor generator run flag	2B	5
DHLDI	Normal door hold input flag	30	3	MLT	Motor limit timer flag	2B	7
DHO	Door hold open flag	21	2	NDGBPS	Nudging bypass flag	23	2
DHOR	Door hold open flag rear	11	2	NDGBPSR	Nudging bypass flag rear	13	2
DIN	Door open inactive	26	4	NDGF	Nudging function flag	30	1
DLI	Dispatch Load Input	38	4	NDS	Hall door timer non-shorten	21	4
DLK	Door lock input	28	7	NDSR	Hall door timer non-shorten rear	11	4
DLKS	Door lock store bit	27	3	NUDG	Nudging output	23	3
DLW	Dispatch load weighing function	38	3	NUDGR	Nudging output rear	13	3

**Table 4.4 Alphabetized Flags, Definitions, and Locations**

FLAG	Definition	Add	Pos	FLAG	Definition	Add	Pos
DMD	Demand down flag	2A	8	NYDS	New York door shortening flag	26	6
DMU	Demand up flag	2A	4	PFM	Passing floor gong output	2F	1
DNDO	Down direction output	29	8	PH1	Phase 1 return complete flag	30	2
DNS	Down direction sense input	24	4	PHE	Photo eye input	20	7
DOB	Door open button input	20	3	PHR	Photo eye input rear	10	7
DOBR	Door open button input rear	10	3	PIC	PI correction flag	25	1
DOC	Door open command	23	8	R2	Absolute floor encoding #2	30	7
DOCR	Door open command rear	13	8	R3	Absolute floor encoding #3	30	6
DOF	Door open function output	22	6	R4	Absolute floor encoding #4	30	8
DOFR	Door open function output rear	12	6	REAR	Rear door flag	28	2
DOI	Door open intent flag	21	1	RUN	Run flag	2B	1
DOIR	Door open intent flag (rear)	11	1	SAB	Sabbath input	33	7
DOL	Door open limit input	20	5	SAF	Safety string input	2C	6
DOLM	Door open limit flag	20	8	SCE	Stepping correction enable	25	8
DOLMR	Door open limit flag rear	10	8	SD	Supervisory down flag	2E	8
DOLR	Door open limit rear	10	5	SDA	Down direction arrow	2E	7
DPD	Down previous direction	29	6	SDT	Short door time flag	22	1
DPR	Door protection timer flag	26	3	SDTR	Short door time flag rear	12	1
DSD	Down slow down input	2E	6	SE	Safety edge input	23	7
DSH	Door shortening flag	2B	2	SER	Safety edge input rear	13	7
DSHT	Door shortening flag	23	1	SLV	Stable slave flag	38	7
DSHTR	Door shortening flag rear	13	1	STC	Stepping complete flag	2C	7
DZ	Door zone input	20	6	STD/R0	Step down input/absolute encoding #0	24	2
DZORDZ	Front or rear door zone input	2D	6	STU/R1	Step up input/absolute encoding #1	24	1
DZP	Door zone previous	2C	8	SU	Supervisory up flag	2E	4
DZR	Door zone input rear	10	6	SUA	Up direction arrow	2E	3
ECC	Excess car calls flag	2F	5	TEMPB	Temporary bit	2D	8
ECRN	Emergency car run flag	2F	3	TEST	Test switch input	33	6
EPI	Emergency power input flag	31	1	TFA	Timing function active	21	8
EPR	Emergency power return	2F	2	TFAR	Timing function active rear	11	8
EPRUN	Emergency power run input	31	2	TFD	Top floor demand flag	2E	1
EPSTP	Emergency power stop input	31	4	TOS	Timed out of service flag	2B	8
FCCC	Fire phase 2 car call cancel	25	7	UC	Up call flag	21	6
FCHLD	Fire phase 2 hold	25	6	UCA	Up call above flag	2A	2
FCOFF	Fire phase 2 off	27	7	UCB	Up call below flag	2A	6
FCS	Fire phase 2 input	24	6	UCR	Up call flag (rear)	11	6
FCSM	Fire service PH 2 input memory	2D	5	UDP	Up direction preference	29	1
FDC	Door fully closed phase 2	21	3	UFP	Upper parking floor flag	26	7
FDCR	Door fully closed phase 2 rear	11	3	UFQ	Up first qualifier flag	2D	7
FRA	Alt. Fire service phase 1 input	24	7	UPD	Up previous direction	29	2
FRAS	Alternate fire flag	2D	2	UPDO	Up direction output	29	4
FRBYP	Fire phase 1 bypass input flag	2F	8	UPS	Up direction sense input	24	3
FRC	Fire phase 2 flag	2D	1	USD	Up slow down input	2E	2
FREE	No demand and in service	30	5	YSIM	Wye simulation bit	27	1
FRM	Fire service phase 1 flag	2D	4				
FRON	Fire phase 1 on input flag	2F	7				

## F1: Program Mode

These parameters define the building, floors and openings to be served, and other basic requirements for the elevator.

Put the car on Inspection and set Function switch F1 up (all others down) to enter Program mode.

Refer to the Programming Record in the Job Prints for a list of the options and values programmed into the controller at MCE.

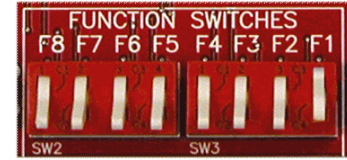

If you make programming changes, record them in the reference table, Appendix A, [page A-21](#).

## General Description of Program Mode

Programmable options and features are divided among several menus:

- |                     |                     |                             |
|---------------------|---------------------|-----------------------------|
| Basic Features Menu | Timer Menu          | Spare Outputs Menu          |
| Fire Service Menu   | Gongs/Lanterns Menu | Extra Features Menu         |
| Door Operation Menu | Spare Inputs Menu   | Additional Car Options Menu |

### Changing Parameters

Enter Program mode. The Start Message will appear:

- Press N to cycle through the menus.
- Press S when the menu you want appears.
- Press N to view the first option in the menu. (Press repeatedly or hold down to cycle through options.)
- Press S to change the value (i.e., from YES to NO).

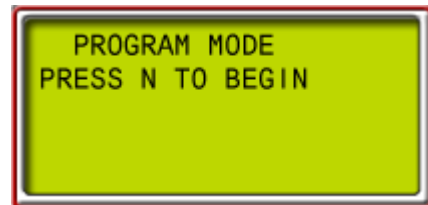

### Saving Changes

After selecting the new value:

- Press N until the save message appears:
- Press S to save changes (or N if you want to cancel the change).

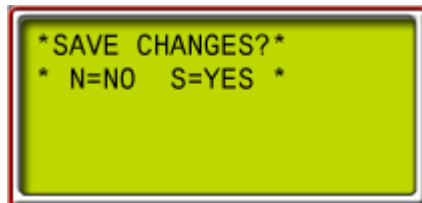
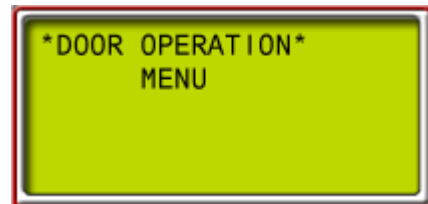

Unsaved changes will be LOST when the F1 switch is placed in the down position (exiting Program mode).

Be sure to enter changed parameter values in the table provided in Appendix A.

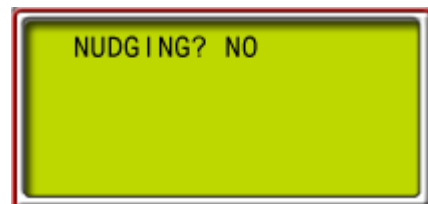
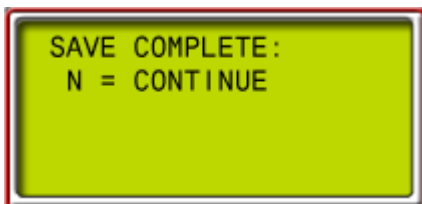
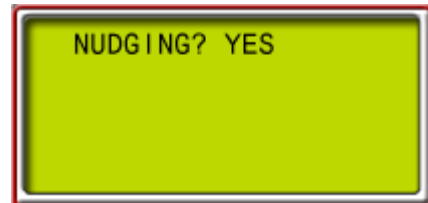

**Viewing Options Within a Menu**

- To return to the top menu level, press the N and '+' buttons at the same time.
- To scroll backwards, press the S and '-' push buttons at the same time.
- To set an option to NOT USED, press the S and '+' buttons at the same time.

**Restoring Original Values Before Saving**

If you have made changes **but have not saved them yet**, you can restore the original values:

- Move the F1 switch back to the down position and the original values will be restored.

**Step-By-Step Example**

The table provides a step-by-step example of using Program mode. In this example, the Fire Phase I Alternate floor will be changed.

**Table 4.5 Parameter Programming Example**

Steps to take	Display menus and sub-menus	
Put the car on Inspection	D INSPECTION OPE PI 8 20:10110000	
Flip F1 switch Up	PROGRAM MODE PRESS N TO BEGIN	
Press N button for Next	*BASIC FEATURES* * MENU *	
Press N button for Next	*FIRE SERVICE* * MENU *	
Press S button to Select		FIRE SERVICE OPERATION? YES
Press N button for Next		FIRE PHASE 1 MAIN FLOOR = 1
Press N button for Next		FIRE PHASE 1 ALT. FLOOR = 1
Press S button to select next available value. If you pass desired value, press S until desired value appears again.		FIRE SVCE. CODE ALT.FLOOR = 3
Press N button for Next		FIRE SVCE. CODE xxxx
Press N button for Next		BYPASS STOP SW. ON PHASE 1? YES
Press N button to scroll through any remaining Fire Service sub-menus.		
Press N button for Next	*FIRE SERVICE* * MENU *	
Press N button for Next	*DOOR OPERATION* * MENU *	
Press N button for Next	* TIMER * * MENU *	
Press N button for Next	*GONGS/LANTERNS* * MENU *	
Press N button for Next	*SPARE INPUTS* * MENU *	
Press N button for Next	*SPARE OUTPUTS*	
Press N button for Next	*EXTRA FEATURES*	
Press N button for Next	* ASME A17.1 * *2000 FEATURES*	
Press N button for Next	*SAVE CHANGES?* * N=NO S=YES *	
Press S button to Save	SAVE COMPLETE: N = CONTINUE	
Press N button for Next	PROGRAM MODE PRESS N TO BEGIN	
Set F1 switch Down. Take car off Inspection	The new options are stored and in effect.	

## Basic Features Menu

- **CONTROLLER TYPE: TRACTION (M4000)**
  - Identifies controller type to the HC-CPU board.
  - Set to TRACTION (M4000). This is the factory default.



### Note

When learning to set parameters, it is very easy to unintentionally set the Controller Type to Motion 2000. If this occurs, you will see the error “MUSE INPUT IS LOW.” To correct, set the Controller Type to M4000, press N repeatedly until the Save Changes menu appears, then press S to save changes.

- **SIMPLEX/LOCAL OR DUPLEX?**
  - Each controller is programmed at the factory for either simplex/local, or duplex operation. If the controller is a simplex, it assigns calls only for itself. The Duplex option will not appear.
  - If the controller is a duplex, it can operate a single car as a simplex or it can be connected to a second Motion 4000 controller and the two can operate as a duplex.
  - Both controllers must have duplex capability for duplexing to work. The option on each controller must be set to duplex. Jumper JP3 on each HC-MPU (lower right corner) must be in place for successful Duplex operation.
  - If the controller is controlled by a group dispatcher, it should be set to Simplex/Local.

In Duplex configuration, one of the controllers will assert itself as the dispatcher and will remain the dispatcher unless it is taken offline. The dispatching controller will show a “D” on its LCD; the other, an “S.” Hall calls are physically connected to both controllers.

- **OPERATION:**
  - Dispatching operation - For simplex operation, you may choose: Selective Collective, Single Button Collective, or Single Automatic Push button:
    - Selective Collective - Use if there is an UP and DOWN button at each landing except for the top floor (DOWN button only) and bottom floor (UP button only) and any number of hall calls can be registered at one time.
    - Single Button Collective - Use if there is only one call button at each landing and any number of calls can be registered at one time.
    - Single Automatic Push button - Use if there is only one call button at each landing and only one call can be registered and/or serviced at a time.



### Note

If Single Button Collective or Single Automatic Push button operation is selected, one of the spare outputs should be used for an INDFRC output. This is used to disconnect hall calls during Fire Service and Independent Service (see “Spare Outputs Menu” on page 4-35, INDFRC output and your job prints for more detail). For duplex operation, the dispatching scheme is always Selective Collective so the Operation option message will not appear if duplex is selected.

**Caution**

Settings that affect the number of floors in the building, openings served per floor, discrete or serial (CE) position indicators, or the presence or absence of a serial car call board determine the sequence of connections on Universal I/O boards used as “call boards” in the controller (UIO boards with addresses from 0 to 31). These settings are made at the factory and should never need to be changed. If you do need to change these settings, disconnect the orange I/O terminal blocks from the UIO boards first, change the settings, then re-wire and re-connect the terminal blocks.

- **TOP LANDING SERVED? (simplex)/TOP LANDING FOR THIS CAR? (duplex)**
  - Set to the highest floor served by this car. See caution above.
- **HC-RDR BOARD ON THIS CAR?**
  - Set to Yes if this car has a second set of doors controlled by an HC-RDR board.
- **CAR SERVES FRNT/FLR 1? (simplex)/THIS CAR SERVES FRNT/FLR 1? (duplex)**
  - Set to YES if this car is eligible to serve a front opening at this floor. (This prompt will reappear for each floor.) See caution above.
  - Press the '+' button to scroll through available landings. Press N for the next option.
- **CAR SERVES REAR/FLR 1? (simplex) / THIS CAR SERVES REAR/FLR 1? (duplex)**
  - Set to YES if this car is eligible to serve a rear opening at this floor. (This option will not be displayed if option CARS ARE WALK-THRU? is set to NO.) (This prompt will reappear for each floor.) See caution above.
  - Press the '+' button to scroll through available landings. Press N for the next option.
  - For a duplex, option inquiries for CARS ARE WALK-THRU?, CAR SERVES FRNT/FLR 1? and CAR SERVES REAR/FLR 1? must be answered for both cars. Each message will ask what the other car's top landing is, if it serves rear floors, etc. Again, select YES if the other car of the duplex serves that floor and NO if the other car does not. Both controllers in a duplex need to be programmed with this information.
- **TOP LANDING FOR OTHER CAR? (duplex)**
  - Set to the highest floor served by the other car of the duplex pair.
- **HC-RDR BOARD ON THE OTHER CAR? (duplex)**
  - Set to Yes if the other car of the duplex pair has a second set of doors controlled by an HC-RDR board.
- **PARKING FLOOR**
  - Any landing may be the parking floor. The car will go to the parking floor when it is free of call demand. There is a Parking Delay Timer that will cause a free car to wait for a short time before parking. The timer is adjustable, with a value between 0.0 minutes (no delay) and 6.0 minutes (see [“PARKING DELAY TIMER \(Range: 0.0-6.0 Minutes\)”](#) on page 4-24).
  - If the parking feature is not needed, choose NONE. The car will then stay at the last call answered.

- **ALT. PARKING FLOOR**
  - Available only when an API input is programmed and a parking floor is set. Any landing can be chosen as the alternate parking floor. The car will go to the alternate parking floor when it is free of call demand and the API input is active.
- **SECONDARY PARKING FLOOR**
  - Does not apply to Simplex. Any landing may be the secondary parking floor. A car will go to this floor when it is free of call demand and the other car is already parked at the first parking floor. It is acceptable to make the secondary parking floor the same as the first parking floor if both cars are to park at the same floor. If a second parking floor is not needed, choose NONE for the Secondary Park Floor option. The first free car will go to the first parking floor and the second car will stay at the last call answered.
- **LOBBY FLOOR**
  - Any landing may be the Lobby Floor. When the car answers a hall or car call at this floor, the doors will stay open until the Lobby Door Timer elapses. The Lobby Door Timer is adjustable (see “[LOBBY DOOR TIMER \(Range: 0.5-120.0 Seconds\)](#)” on [page 4-23](#)). NOTE: The Lobby Floor is also used for the CTL (Car To Lobby) input.
- **CAR IDENTIFIER**
  - Does not apply to Simplex. Specifies which controller is assigned to car A and which to car B, primarily for controllers using a peripheral device such as a monitoring system.



#### Caution

Settings that affect the number of floors in the building, openings served per floor, discrete or serial (CE) position indicators, or the presence or absence of a serial car call board determine the sequence of connections on Universal I/O boards used as “call boards” in the controller (UIO boards with addresses from 0 to 31). These settings are made at the factory and should never need to be changed. If you do need to change these settings, disconnect the orange I/O terminal blocks from the UIO boards first, change the settings, then re-wire and re-connect the terminal blocks.

- **SERIAL COP BOARD HC-CPI?**
  - Set to Yes if the car has a serial call board in the car operating panel that converts discrete car calls to serial data. See caution above.
- **DISCRETE PI’s on UIO?**
  - Set to No if the car uses serial (CE) position indicator fixtures. See caution above.
  - Set to Yes if PI’s are connected to HC-UIO boards.
- **DEDICATED PI BOARD?** (Appears if “Discrete PI’s on UIO?” is set to Yes. Dedicates first one or two HC-UIO boards to PI’s alone [no call connections]).
  - If Yes: Position Indicators will be located on UIO Board 0 (zero) for 2 - 16 stops or boards 0 (zero) and 1 (one) for 2 - 32 stops (board 1 handles 17 - 32 [assuming that PI is one wire per floor]). Calls will begin on a new UIO Board immediately following Board 0 or 1.
  - If No: PI’s are located on UIO boards but calls can begin immediately following the last PI rather than on the next UIO board.

- **SERIAL CARTOP DOOR CONTROL?**
  - Set to Yes if the door operator is connected to an HC-UIO board in the cartop box rather than using multiple connections through the traveler to the HC-CTL board in the controller cabinet.
- **DISABLE LOCAL HALL CALLS?**
  - Set to Yes if the car is dispatched by a group controller and should not respond to a local (connected to car) riser. If this car has swing operation, do not set this to Yes as it will prevent the car from responding to local riser calls.

## Fire Service Menu Options

- **FIRE SERVICE OPERATION?**
  - If Fire Service operation is not required, set to NO. If set to YES, the options below will appear.
- **FIRE PHASE 1 MAIN FLOOR**
  - Any landing may be the Main Fire Return Floor for Fire Service.
- **FIRE PHASE 1 ALT. FLOOR**
  - Any landing may be the Alternate Fire Return Floor for Fire Service.
- **FIRE SVCE. CODE**
  - Fire Service Operation will conform to the selected fire service code. Available codes are:
 

<ol style="list-style-type: none"> <li>1. CHICAGO (OLD)</li> <li>2. VET ADMIN (Veterans' Administration)</li> <li>3. NYC RS-18</li> <li>4. ANSI A17.1 -89&gt;</li> <li>5. CALIF. TITLE 8</li> <li>6. HAWAII</li> <li>7. CSA B44-M90</li> <li>8. 34 PA CODE, CH. 7</li> </ol>	<ol style="list-style-type: none"> <li>9. CITY OF HOUSTON</li> <li>10. AUSTRALIA</li> <li>11. CITY OF DETROIT</li> <li>12. MASSACHUSETTS</li> <li>13. ANSI A17.1 85 - 88</li> <li>14. CITY OF DENVER</li> <li>15. CHICAGO 2001</li> <li>16. ANSI A17.1-2000</li> </ol>
--	--
- **FIRE PHASE I 2ND ALT. FLOOR**
  - Detroit Fire Code only. Any landing may be the 2<sup>nd</sup> alternate fire return floor.
  - Select None if there is no second alternate return floor.
- **WILL THIS CAR RUN ON PH2?**
  - If set to yes, this car is allowed to run on Fire Phase II.
- **BYPASS STOP SW. ON PHASE 1?**
  - Prevents the stop switch from being bypassed on Fire Phase I. When set to NO, the CSB output will not come ON as the car is returning on Fire Phase I.



- **HONEYWELL FIRE OPERATION?**
  - Only if FIRE SVCE. CODE option set to AUSTRALIA (See “FIRE SVCE. CODE” on page 4-16). If set to YES, Australia fire code will conform to Honeywell requirements. If set to NO, controller will conform to standard Australia code.
- **NYC FIRE PHASE 2 AND ANSI 89?**
  - Available only if FIRE SVCE. CODE is set to ANSI A17.1 89 (See “FIRE SVCE. CODE” on page 4-16). If set to YES, ANSI A17.1 89 Fire Code will conform to New York City Fire Code requirements when on Fire Phase 2. If set to NO, controller will conform to standard ANSI A17.1 89 Fire Code.
- **WHITE PLAINS, NY FIRE CODE?**
  - Available only if FIRE SVCE. CODE set to ANSI17.1 89 (See “FIRE SVCE. CODE” on page 4-16). The city of White Plains requires that, if fire phase one is still in effect, the car can exit fire phase two regardless of the position of the doors. Set to YES to comply with this requirement.
- **MASS 524 CMR FIRE CODE?**
  - Available only if “FIRE SVCE. CODE” set to “A17.1 - 2000”. If set to YES, ASME A17.1-2000 fire code will conform to Massachusetts 524 CMR requirements. If set to NO, controller will conform to standard ASME A17.1-2000 code.
- **ASME A17.1A 2000 ADDENDA**
  - Set to the appropriate addenda for your jurisdiction. (2005, 2007, NONE)
- **DISABLE DPM ON FIRE PH.2?**
  - If Yes, Door Position Monitoring is disabled when the car is on In Car Firefighter operation (Fire Phase 2). If No, DPM is not disabled on Fire Phase 2.
- **LOW VOLTAGE FIRE SENSORS?**
  - If the fire sensors on this job use 24V signal levels, set this option to Yes.
  - If set to No, the signal level is assumed to be 120 VAC.
- **LATCH FLASHING FIRE HAT?**

If a fire/smoke sensor in the elevator machine room or hoistway<sup>1</sup> initiates an alarm, the fire hat indicator will flash. A flashing indicator may be reset in one of two ways:

- If this option is set to Yes: Fire service must be reset using the fire service key switch before the indicator will cease flashing. Resetting an individual initiating alarm will not stop the indicator from flashing.
- If this option is set to No: The indicator will stop flashing once the initiating alarm is reset.

---

1. A17.1/B44 code edition/addenda or jurisdiction dependent: (A) for ASME A17.1-2004/CSA B44-04 and later, the machine room or hoistway sensor must be the sensor that initiated Fire Phase I for the hat to flash; or (B) for earlier editions of A17.1/B44, the fire hat will flash any time the machine room or hoistway sensor is active, regardless of which device initiated Fire Phase I. Also, some jurisdictions occasionally modify the A17.1/B44 requirements, so please consult with the jurisdictional authorities for additional requirements.

## Door Operation Menu Options

- **NUDGING?**

- Enables Nudging Operation when doors are prevented from closing. During Nudging Operation, controller will turn ON the NUDG output to signal the door operator to close the doors at reduced speed. The NUDG output will stay ON for the amount of time the Nudging Timer specifies and then cycle off for the same amount of time. This cycle will continue until the doors have fully closed.

The NUDG output can also be used to activate a buzzer. The PHE (Photo Eye) input will be ignored during nudging if the Stuck Photo Eye Protection option has been selected (See [“STUCK PHOTO EYE PROTECTION?”](#) on page 4-18). A Safety Edge or Door Open Button input will stop the doors from closing, but will not reopen the doors fully. Nudging Operation will begin when the Nudging Timer elapses. The Nudging Timer starts when the regular door timer elapses. (See [“NUDGING TIMER \(Range: 10-240 Seconds\)”](#) on page 4-23.)

- **STUCK PHOTO EYE PROTECTION?**

- When enabled, causes controller to ignore PHE (Photo Eye) input and close the doors after the Nudging Timer elapses if the Nudging option is selected or when the Time Out of Service Timer elapses, whichever comes first. If the Nudging option is not selected, the PHE input will be ignored when the Time Out of Service Timer elapses. (See [“TIME OUT OF SERVICE TIMER \(Range: 15-240 Seconds, or None\)”](#) on page 4-23 for more details.)  
If the Stuck Photo Eye Protection option is not selected, a PHE input that is stuck ON will keep the doors open indefinitely.

- **SEQUENTIAL DOOR OPER. (F/R)?**

- Available only if independent rear doors are present. If set to YES, the front and rear doors of the car will not open at the same time. If the controller receives a front and rear call to the same landing, the car will first open and close the front doors, then open and close the rear doors. The default is to open the front doors first unless the rear doors have already started to open.

- **CAR CALL CANCELS DOOR TIME?**

- If selected, pressing a car call button when the doors are fully open will cause the doors to start closing. There is one exception. If the car is stopped at a floor, pressing the car call button for that same floor will not cause the doors to close, but will cause the doors to reopen if they are in the process of closing.

- **NUDGING DURING FIRE PH. 1?**

- If selected, the controller will turn ON the NUDG output while the doors are closing during Fire Phase 1. The NUDG output signals the door operator to close the doors at reduced speed. This is useful for elevators that do not have mechanical safety edges. During Fire Phase 1, all smoke sensitive reopening devices must be disabled. This includes photo eyes and other devices that use infrared beams. If there are no other reopening devices active, the doors should close at reduced speed.

- **RETIRING CAM OPTION?**

- Select for elevators with retiring cams. Affects the car only when it is sitting at a floor. Without this option, the controller will wait until the doors are closed and locked before it turns OFF the door close signal. However, if the elevator has a retiring cam, the doors will not be locked until the retiring cam is activated.

If selected, the controller will turn OFF the door close signal when the doors are closed instead of waiting for the doors to be locked. More precisely, the controller will turn OFF the door close output signal (DCF) when the DCLC (Doors Closed Contact) input is ON or when the DCL (Door Close Limit) input is OFF, instead of waiting for the DLK (Door Lock) input to turn ON.

- **PRE-OPENING?**

- If selected, the controller will begin to open the doors just before the car stops at a floor. More precisely, the controller will turn ON the DOF (Door Open Function) output signal when the DZ (Door Zone) input turns ON. Typically, the DZ input first turns ON when the car is about 3 inches away from the final stopping point. Not recommended for elevators that spend an extended period of time leveling.

- **MECHANICAL SAFETY EDGE?**

- If selected, Nudging Operation will cycle until the doors are fully closed. Otherwise, the nudging function will operate continuously to comply with code requirements where a door reopening device is not used (See “[NUDGING?](#)” on page 4-18 for more details).

- **NUDGING OUTPUT/BUZZER ONLY?**

- If selected with the Nudging option, NUDG output will be activated when Nudging Timer elapses. However, if either the Mechanical Safety Edge or the Door Open button is activated, the doors will stop and reopen fully. If this option is not selected, the doors will simply stop under these circumstances, but will not reopen fully. This option may be useful when only a nudging buzzer is required but actual Nudging Operation is not needed (See “[NUDGING?](#)” on page 4-18 for more details). With this option and the NUDGING option both set to YES, DOOR CLOSE PROTECTION TIMER ELAPSED faults are not generated.

- **D.C.B. CANCELS DOOR TIME?**

- When doors are fully open, this option will cancel any pre-existing door time and cause the doors to start closing when the Door Close button is pressed.

- **LEAVE DOORS OPEN ON MGS?**

- With this option set to yes and the MG Shutdown input active, once the car has stopped at a floor, the doors will remain open instead of cycling closed.

- **LEAVE DOORS OPEN ON PTI/ESS?**

- With this option set to yes and either the Power Transfer (PTI) input or the Elevator Shutdown Switch (ESS) input selected and active, once the car has stopped at a floor, the doors will remain open instead of cycling closed.

- **NUDGING DURING FIRE PHASE 2?**

- If selected, the controller will turn ON the NUDG output while the doors are closing during Fire Service Phase II. The NUDG output signals the door operator to close the doors at reduced speed.

- **DIRECTIONAL PREFERENCE UNTIL DLK?**
  - Causes car to maintain its present direction preference until the doors are fully closed. Otherwise, direction preference is maintained only until door dwell time expires.
- **FULLY MANUAL DOORS?**
  - Set to YES if doors must be opened and closed manually.
- **CONT. D.C.B. TO CLOSE DOORS?**
  - When set to YES, doors will remain open at a landing until the Door Close button is pressed and held. While the Door Close button is pressed, the doors will continue to close. If the Door Close button is released before the doors have closed fully, the doors will re-open.
- **CONT. D.C.B. FOR FIRE PH 1?**
  - When set to YES, doors will remain open when the car goes on Fire Service Phase I until constant DCB forces them closed.
- **MOMENT. D.O.B. DOOR OPENING?**
  - Used to require momentary pressure on the Door Open Button (DOB) to open the doors. If set to NO, momentary pressure on the DOB is not required to open the doors when the car reaches a landing. The doors open automatically in response to a call.
- **MOMENT D.O.B. FOR: (FRONT CALLS/ REAR CALLS/ BOTH CALLS)**
  - Choose whether front calls, rear calls or both calls need momentary D.O.B.
    - FRONT CALLS - Requires that DOB be pressed when the car responds to front door calls. Rear door calls are not affected.
    - REAR CALLS - Requires that DOB be pressed when the car responds to rear door calls. Front door calls are not affected.
    - BOTH CALLS - Requires that DOB be pressed when the car responds to both front and rear door calls.
- **MOMENT D.O.B. FOR: (HALL CALLS/ CAR CALLS/ ALL CALLS)**
  - Choose whether hall calls, car calls, or all calls need momentary D.O.B.
    - HALL CALLS - Requires that DOB be pressed when the car responds to hall calls. Car calls are not affected.
    - CAR CALLS - Requires that DOB be pressed when the car responds to car calls. Hall calls are not affected.
    - ALL CALLS - Requires that DOB be pressed when the car responds to both hall calls and car calls.
- **DOORS TO OPEN IF PARKED: (NONE/FRONT/REAR/BOTH)**
  - If set to NONE, doors remain closed while the car is parked. If set to FRONT, REAR, or BOTH, the corresponding doors automatically open and remain open while the car is parked. This option is available only if a parking floor is programmed in the Basic Features menu. The BOTH option is not available if the car is programmed for sequential door operation (See “[SEQUENTIAL DOOR OPER. \(F/R\)?](#)” on page 4-18)
- **DOORS TO OPEN ON MAIN FIRE?**
  - Choices are FRONT, REAR, and BOTH. Determines which door(s) should open once the car has completed a Main Fire return.

- **DOORS TO OPEN ON ALT FIRE?**
  - Choices are FRONT, REAR, or BOTH. Determines which door(s) should open once the car has completed an Alternate Fire return.
- **LEAVE DOORS OPEN ON CTL?**
  - When set to YES, and the CTL (car to lobby) input is active, once the car has returned to the lobby the doors will remain open instead of cycling closed.
- **LIMITED DOOR RE-OPEN OPTION**
  - Once the doors begin to close after a door dwell time has expired, if a re-opening device input (PHE or SE) is activated, this option allows the doors to re-open as long as the re-opening device is active. Once the re-opening device is inactive, the doors will immediately begin to close again. Without this option set, in this same case, the doors will re-open fully for a (short door) time and then close.
- **REDUCE HCT WITH PHOTO EYE**
  - Causes a normal hall call time to be shortened to a short door time if a photo eye input is seen.
- **LEAVE DOORS OPEN ON EPI**
  - When set to YES, and EPI (Emergency Power) input is active, once the car returns to the emergency power return floor the doors are left open instead of cycling closed.
- **DOORS TO OPEN IF NO DEMAND: (NONE/FRONT/REAR/BOTH)**
  - When set to NONE, the doors remain closed when the car is at a landing with no demand. When set to FRONT, REAR, or BOTH, the corresponding doors automatically open and remain open when the car is at a landing with no demand. The BOTH option is not available if the car is programmed for sequential door operation. (See [“SEQUENTIAL DOOR OPER. \(F/R\)?”](#) on page 4-18.)
- **CONST. PRESS OP. BYPASS PHE?**
  - Used to indicate if Constant Pressure Operations, such as Independent Service, Attendant Service, or if the Constant Pressure Door Close option is set to YES, should bypass the Photo Eye when the Photo Eye is active and there is a demand to close the doors and move the car. When set to YES, the car will bypass the Photo Eye and nudge the doors closed. When set to NO, the car will not bypass the Photo Eye. The doors will remain open until the Photo Eye is cleared.
- **DOOR TYPE IS HORIZONTAL / VERTICAL**
  - Used to indicate if the doors open horizontally or vertically. When set to vertical, requires constant pressure on the door close button (DCB) to shut the doors when exiting Fire Phase 2 away from the recall floor with Fire Phase 1 active (ASME A17.1 requirement).
- **FRONT DOOR MECH. COUPLED? YES/NO**
  - Set to YES if the front car gate is mechanically coupled to the hallway doors. To satisfy A17.1-2000 code requirements, this option is used to qualify the HD Redundancy fault when the Retiring Cam Option is set to YES and this option is set to YES. (See [“RETIRING CAM OPTION?”](#) on page 4-19)

- **REAR DOOR MECH. COUPLED? YES/NO**
  - Set to YES if the rear car gate is mechanically coupled to the hallway doors. To satisfy A17.1-2000 code requirements, this option is used to qualify the HDR Redundancy fault when the Retiring Cam Option is set to YES and this option is set to YES. (See [“RETIRING CAM OPTION?”](#) on page 4-19)
- **PREVENT DCP TIL DOORS CLOSE?**
  - When set to YES, the DCP (door close power) output will not be generated until the doors close and a demand is present. For example, if DCP is used to power the retiring cam RC relay, DCP should be asserted only after the doors have fully closed as indicated by the DCL input.
- **MOMENT. D.C.B TO CLOSE DOORS? YES/NO**
  - When set to YES, a momentary push on the door close button is required to close the doors on normal operation.
  - For automatic door closing, please set this option to NO.
- **DOORS TO LATCH DOF? FRONT/REAR/BOTH/NONE**
  - Maintains the Door Open Function on the selected doors continuously as long as a door closing command is absent.
- **DOORS TO LATCH DCF? FRONT/REAR/BOTH/NONE**
  - Maintains the Door Close Function on the selected doors continuously as long as a door opening command is absent.
- **INV. DOOR CLOSE LIMIT? NONE/ FRONT/ REAR/ BOTH**
  - Set for doors that require inverted door close limit input logic (DCL and/or DCLR). When set, the DCL and/or DCLR inputs must be active when the doors are closed and inactive when the doors are open.
- **FIRE PH2. WITH DOORS CLOSED? Yes/No**
  - **FULLY MANUAL DOORS ONLY:** If set to Yes, a car recalled on Fire Phase 1 is allowed to enter Fire Phase 2 with doors closed.

## Timer Menu Options

- **SHORT DOOR TIMER (Range: 0.5-120.0 Seconds)**
  - Determines length of time doors will stay open after being reopened by Photo Eye, Safety Edge, or Door Open button.
- **CAR CALL DOOR TIMER (Range: 0.5-120.0 Seconds)**
  - Determines length of time doors will stay open when car stops to service a car call.
- **HALL CALL DOOR TIMER (Range: 0.5-120.0 Seconds)**
  - Determines length of time doors will stay open when car stops to answer a hall call.
- **LOBBY DOOR TIMER (Range: 0.5-120.0 Seconds)**
  - Length of time doors will stay open when car stops to answer either a hall call or a car call at Lobby Floor. Location of Lobby Floor is programmable. (See [“CAR SERVES REAR/FLR 1? \(simplex\) / THIS CAR SERVES REAR/FLR 1? \(duplex\)”](#) on page 4-14)
- **NUDGING TIMER (Range: 10-240 Seconds)**
  - Used only if the Nudging option is selected. Door Nudging Operation will begin when Nudging Timer elapses. Nudging Timer will start when regular door timer elapses. This timer also determines the ON and OFF cycle time for the NUDG output. (See [“NUDGING?”](#) on page 4-18)
- **TIME OUT OF SERVICE TIMER (Range: 15-240 Seconds, or None)**
  - Used to take a car out of service when it is held at a floor excessively and calls are registered at other floors. Timer starts when a call is registered at another floor. If timer expires before the car closes its doors and begins to move, the car will be placed out of service. Typically, this occurs when doors are held open by continuous activation of photo eye, a call button, or another reopening device. When NONE is selected, no Time Out of Service timing is performed.

When the timer expires, the Timed Out of Service Indicator on the HC-MPU board will turn ON. The controller will ignore the PHE (Photo Eye) input if the Stuck Photo Eye Protection option is selected. In duplex or group installations, hall calls assigned to the car will be assigned to another car. When the car closes its doors and begins to move again, it will return to Normal service.
- **MOTOR LIMIT TIMER (Range: 1.0 - 6.0 Minutes)**
  - Timer starts when the controller attempts to move the car and is reset when the car reaches its destination floor. If the timer expires before the car reaches its destination, the controller stops trying to move the car to protect the motor. The car is then shut down. The Motor Limit Timer Indicator (MLT) on the HC-MPU board will turn ON.
- **MGR OUTPUT TIMER (Range: 1.0 - 27.0 Minutes)**
  - Timer starts when car is idle at floor. When timer elapses, the motor/generator is shut down. Upon demand, the motor/generator will be restarted and brought up to readiness before the car can move.

- **DOOR HOLD INPUT TIMER (Range: 0-240 Seconds)**
  - Timer used only if there is a DHLD (Door Hold) input to the controller (See [“Spare Inputs Menu” on page 4-26](#)). A Door Hold Open button is usually connected to this input. Timer determines how long the doors will stay open when the door hold open button is pressed. The timer is canceled and the doors will begin to close if either the Door Close button or a Car Call button is pressed. If a Door Hold Key switch (instead of a button) is connected to the DHLD input, timer value should be set to zero so that the doors will close immediately when the switch is turned OFF.
- **PARKING DELAY TIMER (Range: 0.0-6.0 Minutes)**
  - Used only if a parking floor is selected. Timer starts when car is free of call demand. The car will park after the timer expires.
- **FAN/LIGHT OUTPUT TIMER (Range: 1.0-10.0 Minutes)**
  - Used with the FLO output, this timer sets the amount of time that will pass before the FLO output is activated to shut off the car light and fan. Time will start when the car becomes inactive. The FLO output is typically connected to a relay that turns OFF the fan and light in the car. This is also used for PI Turned Off if No Demand.
- **HOSPITAL EMERGENCY TIMER (Range: 1.0-10.0 Minutes)**
  - Sets the amount of time the car will remain at the hospital emergency floor with the doors open before automatically returning to normal service. (See [“HOSPITAL EMERG. OPERATION?” on page 4-45](#).)
- **DOOR OPEN PROTECTION TIMER (Range 8 - 30 Seconds)**
  - Determines how long the door operator will attempt to open the doors. If DOL does not go low within this time, the doors will begin to close.
- **PASSWORD TIMER (Range: 0 - 30 Seconds)**
  - Determines length of time the car will wait for correct password entry through car call COP buttons after a secured car call has been requested before cancelling the call entry cycle. (Applies only to BSI security.)
- **CTL DOOR OPEN TIMER (Range: 2.0 - 60.0 seconds)**
  - Used to specify how long the doors should remain open after car returns to lobby when the CTL (Car to Lobby) input is activated.
- **DOOR BUZZER TIMER (Range: 0 - 30 Seconds)**
  - Determines length of time door buzzer sounds before doors are automatically closed.
- **OPN/CLS INTRLOCK TIMER (Range: 050ms - 950ms, 50ms increments)**
  - Introduces a delay when closing or opening doors are abruptly reversed (i.e., photo eye activation, door button press, etc.). This may be required if the door operator is sensitive to such reversal due to de-bounce capability.
  - Set to NONE if unnecessary.
- **FIRE PH1 RECLOSE TIMER (Range: Disabled or 1 - 120 seconds)**
  - If set to a value other than NONE, the doors will close after the set number of seconds following a Fire Service Phase 1 recall. Doors may be opened using in-car or hall door open buttons.



## Gongs/Lanterns Menu

- **MOUNTED IN HALL OR CAR?**
  - Determines when lanterns and gongs are activated - as the car slows into the floor for hall mounted fixtures or after the door lock opens for car mounted fixtures. If both types of lanterns are used, the Hall option is recommended.
- **DOUBLE STRIKE ON DOWN?**
  - Causes lanterns and gongs to double-strike if car direction preference is down.
- **PFG ENABLE BUTTON? (Passing Floor Gong Enable Button)**
  - If selected, the Passing Floor Gong will operate only when initiated by a momentary pressure button. Once initiated, the Passing Floor Gong will operate for the current direction of travel but will be rendered inoperative when the car reverses direction. The PFGE spare input should also be selected if this option is turned ON. (See “[Spare Inputs Menu](#)” on page 4-26.)
- **EGRESS FLOOR ARRIVAL GONG? / MAIN EGRESS FLOOR #**
  - To program this option (Michigan Code), set one of the spare outputs to EFG. Then set EGRESS FLOOR ARRIVAL GONG? to NO (no gong) or press S to select the floor number where the gong should activate (after the door lock opens). If S is pressed, the display will read MAIN EGRESS FLOOR #1. Press S until the desired floor number is displayed.
- **CAR LANTERN DOOR FULLY OPEN?**
  - If no, the car lantern will come on when the doors begin to open and go off when they are fully closed. If yes, the car lantern will come when the doors are fully open and go off when they begin to close.

## Spare Inputs Menu

The first 10 spare input terminals are located on the HC-CTL board. Additional spare inputs are available on each HC-UIO Universal Input/Output board. [Please refer to “HC-UIO Universal Input/Output Board” on page 5-57.](#) If your installation uses MC-CPI serial control panel boards in the car, spare inputs are also available on these boards and will show up in the Spare Inputs menu as inputs to CPI-F, CPI-Fx, and CPI-R depending upon the car control panel and rear door board configuration. If the job has MC-CPI boards, unused spare inputs to these boards must be set to NOT USED. If controller software is upgraded in the field, it is very important to check programmable CPI board inputs and verify unused inputs are set to NOT USED. [Please refer to “MC-CPI Car Panel Interface Board” on page 5-61.](#)

“Spare” inputs are inputs that can be assigned to a physical board connection through software, allowing great flexibility in configuring a controller to meet specific requirements.

### Viewing and Assigning Spare Inputs

Virtually every elevator installation requires some inputs or outputs that are not “standard.” Perhaps because one site has elevator security requirements while another does not or uses a switch to detect when the machine brake is picked, etc. To accommodate these features without requiring custom software, MCE defines many spare inputs and outputs in standard software that can be assigned to a physical connector and used at need. Jobs are well defined and tested before shipment, allowing MCE to assign, label, and show in the job prints these non-standard inputs or outputs in most cases.

To view assigned spare inputs:

1. Put the car on Inspection and set Function switch F1 up (all others down).
2. Press the N button to cycle through menus until you see “Spare Inputs Menu,” then press the S button to select that menu.
3. The display will show the first “spare” (assignable) connector on the HC-CTL board and the input assigned there.
4. Press the N button to cycle through available assignable connectors in your system and the input, if any assigned.
5. If you want to assign an input to an unused connector, cycle to the desired connector then begin pressing the S button to cycle through available input signals in the order they are shown in the table below. (You can press and hold S to continuously move through the inputs in their numeric/alphabetic order.)
6. When the desired input is shown, press N (it also may be held to cycle) until the Spare Inputs menu is completed and the display again shows the top level menus. Press N until the Save screen is displayed. Save your changes by pressing S when prompted.



#### Note

After selecting an input, you can also press N and + buttons together to go immediately back to the top level menus, then continue to press N until the Save menu is displayed.

Table 4.6 Spare Inputs Menu Options

Spare Inputs Menu Options	
<b>2AB</b>	2AB relay coil monitoring input - If the 2AB relay is ON, the R2AB input will be OFF. R2AB must always be the opposite of 2AB. If not, the 2AB redundancy fault is logged and the elevator shuts down.
<b>ABI</b>	Alarm Bell Input - There are three conditions that will initiate a warning. First, if the Alarm Button is pressed when the car is stopped outside of a door zone. Next, if the Alarm Button is pressed four times in 60 seconds without the car moving. Lastly, if the car fails to complete an LSA movement check after being idle for 10 minutes at a landing. All of these failures will alert the monitoring station.
<b>ACI</b>	Reserved for future use.
<b>ALI</b>	Alternate Lobby Input - The ALI input is used to substitute the Main Lobby floor value with an Alternate Lobby floor value. When the ALI input is activated, the lobby value is taken not from the LOBBY parameter, but from the ALTLBY parameter. The ALTLBY floor must be specified before using the ALI input.
<b>ALV</b>	Alive Input - Used in a duplex configuration; received from the other car. If the input is on, it indicates the other car is powered. Used in emergency power applications.
<b>API</b>	Alternate Parking Input - Used to determine whether to park at the primary or alternate parking floor. When API is low, the car will park at the primary floor. When API is high, the car will park at the alternate floor.
<b>ARST</b>	Alarm Reset Acknowledge input. Reset an alarm initiated by the ABI input or by an open safety string. When active, will not allow the DISL, TDISL, and DISB outputs to operate.
<b>ATS</b>	Attendant Service Input - When active, the car is controlled by an attendant (starting, stopping, direction of travel). Doors open automatically when car is stopped at a landing. Doors close only with constant pressure on the door close button, car call button, or a car direction button (UPI or DNI). Attendant may cause the car to bypass all hall calls by activating the "non-stop button" (NSI). The ATSOPT option must also be enabled. While the car is on Attendant Service, all Load Weigher Functions (LLW, HLW, OLW) are cleared.
<b>AUTO</b>	Emergency Power Auto Selection Input - Duplex operation. When activated, one of the cars is automatically chosen to run on emergency power. The dispatcher makes this decision, and will choose itself if able to run. The other car will be chosen if the dispatcher is unavailable to run. See also the ALV input.
<b>AXR</b>	Auxiliary Reset Input - Used to reset redundancy error conditions. Typically connected to a push button.
<b>BAB</b>	Monitoring input for BAB relay coil. If BAB relay is ON, RBAB input will be OFF. RBAB must always be the opposite of BAB. If not, a BAB redundancy fault is logged and the elevator shuts down.
<b>BPCR</b>	Backup Power alerting input from the MCE TAPS Traction Auxiliary Power Supply. Lets the elevator know that it is receiving backup power so that correct operating parameters for this situation may be employed. (From the TAPS UPS-1 output)
<b>BPS</b>	Brake Pick Switch input. The brake pick switch/sensor monitors the position of the machine brake. Three seconds after a run is initiated, the controller checks the status of this input to see that the BPS is deactivated (low), indicating the brake is fully picked. If the brake is picked, the controller stops monitoring the input for that run. If the brake is not picked, the controller continues to monitor throughout the run and, if the brake does not pick, a fault is reported and the car will be shut down at the end of that run. If the controller detects that the brake is not fully picked initially but picks during the run and this behavior continues for three consecutive runs, a fault is reported and the car shut down after the third run.
<b>BSI</b>	Building Security Input - Used to activate MCE Security when the MASTER SOFTWARE KEY, in the Extra Features Menu ( <a href="#">Please refer to "Building Security Menu" on page 4-53</a> ), is set to ENABLED.
<b>CCC</b>	Car Calls Cancel Input - Activation will unconditionally cancel car calls. Because this input has no logical software qualification, necessary qualification must be done in external circuitry (e.g., disable the signal feeding this input when on Fire Service Phase II).

Table 4.6 Spare Inputs Menu Options

Spare Inputs Menu Options	
<b>CNP</b>	Contactors Proof Input - Monitors the normal condition of motor/start contactors and will shut the car down if the contactor fails to make or break contact properly. Generates a Contactor Proofing Redundancy Failure message.
<b>CR1-CR8</b>	Car call card reader. Used to enable car call registration to secured front landings. Bypassed during fire service Phase II operation.
<b>CR1R-CR8R</b>	Car call card reader, rear. Used to enable car call registration to secured rear landings. Bypassed during fire service Phase II operation.
<b>CRO</b>	Car call card reader override. When active, car calls may be registered without restriction.
<b>CTF</b>	Car to floor Input - Used to return the car to a previously selected floor. The return floor is selected using CAR TO FLOOR RETURN FLOOR in the EXTRA FEATURES MENU. When activated, this input will cause the car to immediately become non-responsive to hall calls, and will prevent registration of new car calls. Depending upon the setting of Retain Calls, car calls registered prior to activation of the CTF input will be serviced before, or retained for service after, recall. Please refer to "RETAIN CALLS ON CTL / CTF?" on page 4-48.
<b>CTL</b>	Car-to-Lobby Input - Used to return the car to the lobby floor. When activated, this input will cause the car to immediately become non-responsive to hall calls, and will prevent the registration of new call calls. Depending upon the setting of Retain Calls, car calls registered prior to activation of the CTL input will be serviced before, or retained for service after, recall. Please refer to "RETAIN CALLS ON CTL / CTF?" on page 4-48.
<b>CTST</b>	Capture for Test Input - Causes the car to bypass Hall Calls and disable gongs. Car Calls will still be answered and allowed to be entered.
<b>CWI</b>	Counterweight Input. Used in conjunction with EDS and EQI inputs for ANSI and modified California Earthquake Operation. This input tells the computer that the counterweight has moved horizontally beyond normal limits. Activation of this input while a car is in flight will cause an emergency stop. When the car moves to a landing after stopping, it will move in a direction away from the counterweight (historical activity of EDS input determines which direction). For ANSI, continuous activation of CWI is monitored (this information is used to determine if the car will be allowed to run "normally" at reduced speed). For California, CWI is monitored to determine if the car will be allowed to run on fire service or hospital emergency service. Please refer to "ANSI EARTHQUAKE/CALIF EARTHQUAKE" on page 4-48.
<b>DCL</b>	Door Close Limit Input - Associated switch opens when the car door is approximately 1 inch from being closed, causing input to go low. Opening the door approximately 1 inch will reapply power to the DCL input as the switch makes up.
<b>DCLC</b>	Doors Closed Contact Input - When active (high), indicates doors are closed on Retiring CAM (RETCAM) jobs. Since the doors do not lock until the car is ready to move, the computer needs to see this input to know when the doors are closed.
<b>DCLR</b>	Doors Closed Contact Input Rear - When active (high) indicates rear doors are closed on Retiring CAM (RETCAM) jobs. Since the doors do not lock until the car is ready to move, the computer needs to see this input to know when the doors are closed.
<b>DFI</b>	Drive Fault Input - The fault output of the drive may be connected to this input for drive fault detection and recording.
<b>DHLD</b>	Door Hold Input - Activates DHO output to open and hold doors for the period the input is active plus the DLHD timer value. Please refer to "DOOR HOLD INPUT TIMER (Range: 0-240 Seconds)" on page 4-24. Pressing the door close or a car call button will cancel DHLD time. Fire Service disables the input.
<b>DHLDR</b>	DHLD for Rear Doors - See description of DHLD.
<b>DLI</b>	Dispatch Load Input - A load weigher is typically connected to this input. When the input is activated, door dwell time will be curtailed when the elevator has an up direction at the Lobby Floor.

Table 4.6 Spare Inputs Menu Options

Spare Inputs Menu Options	
<b>DLS</b>	Door Lock Sensor Input - Monitors the state of the contacts in the landing door lock string. Power will be present on the DLS input when all the landing doors are closed and locked. Used for CSA code with Door lock bypass requirement. NOTE: It is mandatory to have the DCL input programmed when DLS is used.
<b>DLSR</b>	Door Lock Sensor Input (Rear) - See DLS.
<b>DNI</b>	Down Input (Attendant Service) - Used by attendant during Attendant Service operation to establish a direction preference. Pushing the "DOWN" button in the car activates the input, causing the computer to generate SDA (down direction preference) and DSHT (door shortening) to close the doors.
<b>DOL</b>	Door Open Limit input - Active high input from door open limit switch.
<b>DOLR</b>	Door Open Limit Rear input - Active high input from rear door open limit switch.
<b>DPM</b>	Front Door Position Monitoring - Switch makes when car door is approximately 1 inch from being closed, activating (high) DPM input. Opening the door approximately 1 inch removes power from DPM as the switch opens.
<b>DPMR</b>	Rear Door Position Monitoring - See DPM.
<b>DRON</b>	Drive On Input. This input is used to indicate to the microprocessor that the drive is ON and Ready.
<b>DSTI</b>	Door Stop Input - If doors are opening or closing when this input is detected, door operation will stop. DOF and DCF/DCP flags are cleared. If the DSTI input is momentary, the doors may be opened or closed using DOB or DBC inputs. If the DSTI input is constant, DOB or DBC will not override it. This operation will not function in Fire Service, Inspection, or Independent service.
<b>DSTIC</b>	Door Stop Input Complement. Active low. (See DSTI.)
<b>DSTICR</b>	Door Stop Input Complement Rear. Active low. (See DSTI.)
<b>DSTIR</b>	DSTI for rear doors - See DSTI.
<b>DZRXX</b>	Programmable auxiliary rear door zone input. Can be assigned to SPIN-1 through SPIN-6 on HC-CTL board or to an HC-UIO board and used in place of DZR input on HC-RDR board.
<b>DZX</b>	Programmable, auxiliary front door zone input. Can be assigned to SPIN-1 through SPIN-6 on HC-CTL board or to an HC-UIO board and used in place of DZF input on HC-CTL board.
<b>ECRN</b>	Emergency Car Freeze Input - Used during emergency power to immobilize a car while other cars are returned to the assigned landing. The EPR input must also be programmed to select the car to run.
<b>EDS</b>	Earthquake Direction Switch. This input is activated when the car is in line with the counterweight. When the controller receives the momentary EDS input, it will note in what direction the car was traveling to determine the position of the counterweight relative to the car (counterweight above car, or counterweight below car). This position status is used to safely move the elevator in the event of an earthquake.
<b>EDTLS</b>	Earthquake Direction Terminal Limit Switch - When active, indicates that the car is above the counterweight. When inactive, indicates the car is below the counterweight.
<b>EMSC</b>	Emergency Medical Service (EMS) in-car switch input - When activated, places the car on EMS phase two operation (car calls may be registered).
<b>EMSH</b>	Emergency Medical Service (EMS) hallway switch input - When activated, recalls car to the designated EMS floor.
<b>EPI</b>	Emergency Power Input - Indicates loss of commercial power when input goes low. <a href="#">Please refer to "EMERGENCY POWER OPERATION?/EMERGENCY POWER RETURN FLOOR" on page 4-42.</a>
<b>EPR</b>	Emergency Power Return Input - Used during emergency power. When activated, car is lowered to the recall floor. The ECRN input must also be programmed.

Table 4.6 Spare Inputs Menu Options

Spare Inputs Menu Options	
<b>EPRUN</b>	Emergency Power Run Input - Wired to the "Run" switch for emergency power car selection. The "dispatcher" in a duplex system will reference this input when deciding which car should be allowed to run on emergency power. Each car must have its own EPRUN input. Which-ever is selected will be chosen to run on Emergency Power Phase II.
<b>EPSTP</b>	Emergency Power Stop Input - When activated before the lowering sequence, holds the car immobilized, preventing the emergency power transition timer from running. Used to coordinate emergency power operation with other systems.
<b>EQI</b>	Earthquake Input. When this input is activated, the car will proceed to the next floor at reduced speed and shut down with doors open. The car will remain shut down until EQI is deactivated again for California jobs. For ANSI jobs, the car will go into reduced speed mode after 30 seconds (EQN timer) if the CWI input is not activated.
<b>ESS</b>	Elevator Shutdown Input - When activated, the car stops at the next landing in the direction of travel, cycles the doors, and shuts down. Bypassed by Fire, Inspection, Independent, Attendant and Hospital service.
<b>FCCC</b>	Fire Phase II Call Cancel Button Input - When activated during Fire Phase II operation, cancels all registered car calls.
<b>FCHLD</b>	Fire Phase II Door Hold Input - When activated during Fire Phase II operation, fully open doors will not be allowed to close. The "HOLD" position of the In-car Fireman Service switch is wired to this input.
<b>FCOFF</b>	Fire Phase II OFF Input - Used to take the elevator out of Fire Phase II service. The "OFF" position of the In-car Fireman Service switch is wired to this input.
<b>FLTM</b>	TAPS Fault input. Alerts the controller if the Traction Auxiliary Power Supply unit has faulted.
<b>FRAA</b>	Fire Phase I Second Alternate Input - Required by Detroit fire code. When activated, initiates emergency return to the second designated alternate floor (FRA must also be active). The alternate fire return floor sensor should activate this input.
<b>FRAON</b>	Fire Phase I Alternate Switch ON Position Input - This fire service switch input is second in priority to the main switch input (FRON) but will override the sensor inputs. When the input is ON, the car will return to the alternate fire floor.
<b>FRBYP</b>	Fire Phase I Switch BYPASS Position Input - When activated, causes the system to ignore the fire sensors (restoring normal fire service status if the fire service switch is not active) and unlatches the current fire sensor status.
<b>FRHTW</b>	Hoistway Fire Sensor - (Normally high) Deactivating this input initiates recall to the main fire floor and causes the FWL output to flash.
<b>FRMR</b>	Machine room fire sensor - (Normally high) Deactivating this input initiates recall to the main fire floor and causes the FWL output to flash.
<b>FRON</b>	Fire Phase 1 Switch ON Position Input - When activated, places the system in Fire Service Phase I operation. The "ON" position of the fire recall switch is typically wired to this input.
<b>FRON2</b>	Fire Phase 1 Switch ON Position Input (additional input - same as FRON).
<b>FRSA</b>	Alternate Fire Service - Normally active input. When this input goes low, Alternate Fire Service operation is initiated and the FWL output (Fire Warning Light) will flash.
<b>FRSM</b>	Main Fire Service - Normally active input. When this input goes low, Main Fire Service operation is initiated and the FWL output (Fire Warning Light) will flash.
<b>GOV</b>	Governor switch input.
<b>GS</b>	Gate Switch Input - Makes up when the car door is approximately 1 inch from fully closed. With the car door closed, there should be power on the GS input. This input is used for CSA door lock bypass and redundancy logic. NOTE: It is mandatory to have the DCL spare input programmed whenever GS is used.
<b>GSR</b>	Gate Switch Rear Input - Indicates the rear car gate is closed. Used for CSA door lock bypass and redundancy logic.
<b>HBF</b>	Hall Call Bus Failure input - input from the group controller indicating that the serial hall call bus has failed. Without hall call direction, local cars will begin "stop at each floor" operation to collect passengers and continue to provide service to the building.

Table 4.6 Spare Inputs Menu Options

Spare Inputs Menu Options	
HCC	Hall Call Cancel. When activated, all hall calls are canceled.
HCR1 - 8	Hall Card Reader Inputs for front landings. Used to enable registration of front hall calls on secured floors.
HCR1R-8	Hall Card Reader Inputs for rear landings. Used to enable registration of rear hall calls on secured floors.
HCRO	Hall Card Reader Override input. When active, causes the car to bypass Per Floor Hall Card Reader security inputs. Hall Calls will be permitted without enabling the Hall Card Reader inputs.
HDCB	Hall Door Close Button. When activated, initiates door closing for front door. Disabled during fireman operation, Fire Phase II.
HDCBR	Hall Door Close Button. When activated, initiates door closing for rear door. Disabled during fireman operation, Fire Phase II.
HDOB	Hall Door Open Button. When activated, initiates door opening for front door. Disabled during fireman operation, Fire Phase II.
HDOBR	Hall Door Open Button. When activated, initiates door opening for rear door. Disabled during fireman operation, Fire Phase II.
HDSTI	Hall Door Stop Input. When activated, stops front door movement until door open or door close button is pressed. Disabled during fireman operation, Fire Phase II.
HDSTIR	Hall Door Stop Input Rear. When activated, stops rear door movement until door open or door close button is pressed. Disabled during fireman operation, Fire Phase II.
HEATD	Heat Detector Input - Detroit Fire Code. Connected to a heat detector in the machine room and used to stop the car at the next floor and open the doors (same as PTI). Once the doors are fully open, the HDSC spare output is turned off indicating it is okay to remove power from the controller and activate machine room sprinklers.
HLI	Heavy Load Input - Indicates car is loaded to a point at which it should no longer accept hall call assignments (heavy load bypass). A "discrete" load weigher contact is typically wired to this input, usually indicating that the load is 75%-80% of full load.
HML	Home Landing Input - Used with the primary parking feature to determine whether the car will park or not. The HLSOPT option must also be enabled.
HOSP	In-car Hospital Service Switch Input - Initiates Hospital Service Phase 2 operation. Typically wired to a keyed hospital service switch located inside the car. Upon activation, the car will accept a call for any floor and proceed nonstop to that floor after the doors close. Deactivation restores normal operation of the car. <a href="#">Please refer to "HOSPITAL EMERG. OPERATION?" on page 4-45.</a>
INA	Monitoring input for the INAX relay coil.
INSDN	Inspection Down Input - Indicates intent to move down while on Inspection operation.
INSUP	Inspection Up Input - Indicates intent to move up while on Inspection operation.
INT	Intermediate speed input.
IRCOF	Front Infrared Cutout - Normally active. When this input goes low, the infrared detector signal is ignored for the front door only and the door will always close at reduced torque and speed, i.e., nudge closed unless the door requires a constant door close button signal to close. In this case the door will close at full speed.
IRCOR	Rear Infrared Cutout - Normally active. When this input goes low, the infrared detector signal is ignored for the rear door only and the door will always close at reduced torque and speed, i.e., nudge closed unless the door requires a constant door close button signal to close. In this case the door will close at full speed.
LLI	Light Load Input - When activated the elevator will only allow the number of car calls specified by the Light Load Car Call Limit parameter to be registered. If more are registered, all car calls are canceled. A discrete load weigher contact is typically wired to this input, indicating that a very minimal passenger load exists in the car. <a href="#">Please refer to "LIGHT LOAD WEIGHING? / LIGHT LOAD CAR CALL LIMIT" on page 4-43.</a>

Table 4.6 Spare Inputs Menu Options

Spare Inputs Menu Options	
<b>LSR</b>	Landing System Redundancy Input - Redundancy checking. Monitors the door zone (DZ) level down (LD) circuits. On any run between floors, the LSR input should go low at least once. If, however, the DZ sensor has failed closed, power will be present continuously on the LSR input and the car will not be permitted to restart. "LANDING SYSTEM REDUNDANCY FAILURE" will be displayed on the LCD. If either the LU or LD sensors fail closed, the controller will not permit the car to restart.
<b>LWB</b>	Load Weigher Bypass - Used to bypass load weigher inputs (LLI, HLI, OVL and DLI).
<b>MGS</b>	When the MGS input is activated, all car calls are immediately canceled (hall calls will be reassigned, if possible) and the elevator will return to the specified floor, cycle the doors, and be removed from service. This operation is overridden by fire service and other special operations.
<b>MNO</b>	Manual Override. When activated, automatic lowering is overridden. The car will recall to the next available landing and complete the recall process.
<b>NSI</b>	Non-Stop Input (Attendant Service) - Activation causes the car to bypass all hall calls. The input is enabled only when the car is on Attendant operation.
<b>OVL</b>	Overload Input - While the car is stopped at a landing with the doors open, activation of this input indicates there is too much weight in the car. Doors will be held open until the overload condition is cleared and the input goes low. Fire Service will bypass OVL.
<b>OVL2</b>	Overload 2 Input - While on Fire Phase II, when the car is stopped at a landing with the doors open, activation of this input indicates there is too much weight in the car. Doors will be held open until the overload condition is cleared and the input deactivated (ANSI A17.1-2000 fire code only).
<b>PFGE</b>	Passing Floor Gong Enable Input - Used mostly on New York City jobs. Normally there is not an output from the PFG. When this input is momentarily activated, there will be a PFG output as the car passes a floor until the elevator reverses direction (also referred to as "S" button). <a href="#">Please refer to "PFG ENABLE BUTTON? (Passing Floor Gong Enable Button)" on page 4-25.</a>
<b>PHEX</b>	Programmable, auxiliary photo eye input, front. May be assigned to SPIN1 - SPIN6 on HC-CTL board or to an HC-UIO board and used instead of the PHE input on the HC-CTL board.
<b>PHRX</b>	Programmable, auxiliary photo eye input, rear. May be assigned to SPIN1 - SPIN6 on HC-CTL board or to an HC-UIO board and used instead of the PHER input on HC-RDR board.
<b>PITFLD</b>	Pit Flood. Activated by pit flood sensor. When activated, the car recalls to the lowest landing above floor level, after which it returns to normal service without serving the inaccessible floors. Renders the floors set in the Extra Features menu "# of flrs below floor level" inaccessible. Fire, Parking, and Emergency floors, if below flood level, will be automatically set to the first available landing above floor level.
<b>PTI</b>	Power Transfer Input - When activated, causes the car to stop at the next landing in the direction of travel, open the doors (in accordance with the "LEAVE DOORS OPEN ON PTI/ESS?" parameter) and shut down. Used when transferring from normal to emergency power (testing), emergency to normal power, as the battery or charger fault input from the video rescue system, and/or the overspeed governor slow down switch. Note: The PTI input may be used as a general elevator shut down input in a variety of circuits. Please refer to the job prints for details when this input is found to be active.
<b>PTIC</b>	Complementary PTI Input - Provides reverse logic for the PTI function. PTI operation is initiated when this input goes low.
<b>R2AB</b>	Redundancy monitoring input from the 2AB relay contact. (See description of 2AB input).
<b>R5, R4, R3, R2</b>	Floor Encoding Inputs - Required for absolute floor encoding. NOT USED.
<b>R2L</b>	Redundancy 2L bus. Used to monitor the normally closed contact of an additional 2L relay.
<b>RBAB</b>	Redundancy monitoring input for the BAB relay contact. (See description of BAB input).



Table 4.6 Spare Inputs Menu Options

Spare Inputs Menu Options	
<b>RDLSR</b>	Rear Door Lock Relay Redundancy input (CSA Redundancy) - Monitors the state of the DLSR relays (there are 2). Activated if either relay is "picked" (a normally open contact from one relay is wired in parallel with a normally open contact from the other relay to feed this input). Logic compares the state of the RDLSR input with the state of the DLSR input (the DLSR input monitors the string of actual door lock contacts) to see if one of the two DLSR relays has failed in the "picked" mode (if DLSR=0 and RDLSR=1, a failure is declared).
<b>REO</b>	Re-Open Input - Houston fire code requires that doors close after completing a Fire Phase I return. A key switch in the hallway connected to this input is used by the fire person to reopen the doors.
<b>REOA</b>	Re-Open Input Alternate - Houston fire code requires that doors close after completing a Fire Phase I return. A key switch in the hallway connected to this input is used by the fire person to reopen the doors at the Alternate recall floor.
<b>REVD</b>	Reverse Direction input from the MCE TAPS Traction Auxiliary Power Supply unit. (From TAPS Rev output)
<b>RGS</b>	Redundancy Gate Switch (front) - Monitors the state of the GS relays (there are 2). Activated if either relay is "picked" (a normally open contact from one relay is wired in parallel with a normally open contact from the other relay to feed this input). The logic compares the state of the RGS input with the state of the GS input (the GS input monitors the actual car gate contact) to check if one of the two GS relays has failed in the "picked" mode (if GS=0 and RGS=1, a failure is declared).
<b>RGSR</b>	Redundancy Gate Switch (rear) - Monitors the state of the GSR relays (there are 2). Activated if either relay is "picked" (a normally open contact from one relay is wired in parallel with a normally open contact from the other relay to feed this input). The logic compares the state of the RGSR input with the state of the GSR input (the GSR input monitors the actual rear car gate contact) to check if one of the two GSR relays has failed in the "picked" mode (if GSR=0 and RGSR=1, a failure is declared).
<b>RINAX</b>	Redundancy monitoring input for the INAX relay contact.
<b>RUN/A/B</b>	Active when car is selected to run on emergency power. A and B are used for duplex.
<b>SAB</b>	Sabbath Operation Input - Selects Sabbath Operation in which the car will move through the hoistway, stopping at landings that are programmed in the Extra Features Menu.
<b>SAFC</b>	Car safety string input.
<b>SAFH</b>	Hoistway safety string input.
<b>SIMP</b>	Simplex Input - Activation causes a duplex car to behave as a simplex. The car will respond to hall calls registered on its own call circuitry, will not accept hall calls assigned to it by another controller, and will perform its own parking function independently.
<b>STARTIN</b>	Start Input - Used for the START position of the three position Fire Phase II switch for Australian jobs. Causes the front and rear doors to close. The car will not proceed to answer car calls during Fire Phase II until the STARTIN input has been activated.
<b>STDY</b>	Programmable, auxiliary step down input. May be assigned to SPIN1 - SPIN6 on HC-CTL board or to an HC-UIO board and used instead of STD input on HC-CTL board.
<b>STUX</b>	Programmable, auxiliary step up input. May be assigned to SPIN1 - SPIN6 on HC-CTL board or to an HC-UIO board and used instead of STU input on HC-CTL board.
<b>STOP</b>	When active, the car will immediately stop so long as the input is active or until the input is bypassed and the car is commanded to move.
<b>SWG</b>	Swing Input. When active will disconnect from the group and act as a simplex, responding to calls from its independent riser. Disable Local Hall Calls, <a href="#">page 4-16</a> , must be set to NO.
<b>UDF</b>	Up and Down direction relay fault input.
<b>UFL</b>	Up Final Limit Input - This is a latching input that monitors the up final limit. Deactivation of this input will shut the elevator down and require a manual reset.

**Table 4.6 Spare Inputs Menu Options**

<b>Spare Inputs Menu Options</b>	
<b>UPI</b>	Up Input (Attendant Service) - Used by an attendant during attendant service operation to establish a direction preference. Pushing the "UP" button in the car will activate this input, causing the computer to generate SUA (up direction preference) and DSHT (door shortening) to close the doors.
<b>WLD</b>	Emergency Dispatch Input - Causes Wild operation (emergency dispatching) to be disabled. Created to allow building personnel or elevator maintenance personnel to disable emergency dispatching on one or more cars in a multi-car system. For example, if the dispatcher of an 8-car group were to fail, the building may only want 3 cars to run on "wild operation". The remaining 5 cars would be inhibited from running on "wild operation" by activating the WLD input for each.
<b>WPIA - WPIH</b>	Bracelet Security (Wandering Patient Security) inputs. These inputs work in conjunction with the WPIA Landing/Side (opening) option in the Extra Features menu. Landing and side options must be set for each WPIx input programmed. When a WPIx input is activated, hall calls to the programmed landing and side associated with the input will be disabled. If the elevator is already located at that landing with the doors open, it will be prevented from leaving that landing and will shut down. (AKA Infant Abduction Security)

## Spare Outputs Menu

The first four spare output terminals are located on the HC-CTL board. Additional spare outputs are available on each HC-UIO Universal Input/Output board. [Please refer to “HC-UIO Universal Input/Output Board” on page 5-57.](#) If your installation uses MC-CPI serial control panel boards in the car, spare outputs are also available on these boards and will show up in the Spare Outputs menu as outputs from CPI-F and CPI-Fx, or CPI-R depending upon the car control panel and rear door board configuration. If the job has MC-CPI boards, unused spare outputs from these boards must be set to NOT USED. If controller software is upgraded in the field, it is very important to check programmable CPI board outputs and verify unused outputs are set to NOT USED. [Please refer to “MC-CPI Car Panel Interface Board” on page 5-61.](#)

“Spare” outputs are outputs that can be assigned to a physical board connection through software, allowing great flexibility in configuring a controller to meet specific requirements.

### Viewing and Assigning Spare Outputs

Virtually every elevator installation requires some inputs or outputs that are not “standard.” Perhaps because one site has elevator security requirements while another does not or uses a switch to detect when the machine brake is picked, etc. To accommodate these features without requiring custom software, MCE defines many spare inputs and outputs in standard software that can be assigned to a physical connector and used at need. Jobs are well defined and tested before shipment, allowing MCE to assign, label, and show in the job prints these non-standard inputs or outputs in most cases.

To view assigned spare outputs:

1. Put the car on Inspection and set Function switch F1 up (all others down).
2. Press the N button to cycle through menus until you see “Spare Outputs Menu,” then press the S button to select that menu.
3. The display will show the first “spare” (assignable) connector and the output assigned there.
4. Press the N button to cycle through available assignable connectors in your system and the output, if any assigned.
5. If you want to assign an output to an unused connector, cycle to the desired connector then begin pressing the S button to cycle through available output signals in the order they are shown in the table below. (You can press and hold S to continuously move through the outputs in their numeric/alphabetic order.)
6. When the desired output is shown, press N (it also may be held to cycle) until the Spare Outputs menu is completed and the display again shows the top level menus. Press N until the Save screen is displayed. Save your changes by pressing S when prompted.

Note

After selecting an output, you can also press N and + buttons together to go immediately back to the top level menus, then continue to press N until the Save menu is displayed.

Table 4.7 Spare Outputs Menu Options

Spare Outputs Menu Options	
<b>702-709</b>	Front Down Hall Call indicators. Typically used for hall gongs or chimes and activated as the elevator levels into the associated landing. See drawings package. Do not use if a dedicated HC-UIO board is used for Hall Call Indicators.
<b>702R-709R</b>	Rear Down Hall Call indicators. Typically used for hall gongs or chimes and activated as the elevator levels into the associated landing. See drawings package. Do not use if a dedicated HC-UIO board is used for Hall Call Indicators.
<b>801-808</b>	Front Up Hall Call indicators. Typically used for hall gongs or chimes and activated as the elevator levels into the associated landing. See drawings package. Do not use if a dedicated HC-UIO board is used for Hall Call Indicators.
<b>801R-808R</b>	Rear Up Hall Call indicators. Typically used for hall gongs or chimes and activated as the elevator levels into the associated landing. See drawings package. Do not use if a dedicated HC-UIO board is used for Hall Call Indicators.
<b>900</b>	Audible Car Call Registered Output - Generated by registration of a car call. Used to comply with specific handicap ( <i>barrier-free</i> ) codes that require an audible acknowledgment of car call registration.
<b>ABZ</b>	Attendant Service Buzzer Output - Generated momentarily when a hall call button is pushed while the elevator is on attendant operation. Used for an in-car buzzer to alert the attendant.
<b>BOTTOM</b>	Bottom landing output. Activates when the car reaches the bottom landing. Used to facilitate load weigher calibration if needed.
<b>CCDE</b>	Car Call Disconnect Enable Output - Comes on when car calls are canceled during photo-eye anti-nuisance operation.
<b>CCT</b>	Car Call Time Flag Output - Represents the state of the CCT flag. Activated when a car call is canceled and deactivated when the door dwell time elapses (or is canceled by pressing a car call or door close button).
<b>CD</b>	Car Done Returning on Emergency Power Output - Active when the car has finished returning on emergency power or when it is determined that the car cannot return.
<b>CEPR</b>	Complete Emergency Power Return. Generated when the car has completed emergency power return to the recall landing and is parked with doors open.
<b>CFLT</b>	CSA FAULT OUTPUT - On when there is a CSA Redundancy fault condition (CNP, ILO and UDF only). Used for Canadian Standards Association (CSA) code. If applicable, refer to the job Compliance Report.
<b>CGED</b>	Car Gong Enable Down Output - Generated to activate the in-car gong/lantern (front doors). Activated (usually a double ding: on-off-on) to announce intention to move down after the doors start to open. This will happen when a down hall call front has been entered and the car has reached the floor the call originated from or if the doors are open and a car call front is entered for a floor below.
<b>CGEDR</b>	CGED for rear doors Output - Same as CGED but for the rear gong/lantern.
<b>CGEU</b>	Car Gong Enable Up Output - Generated to activate the in-car gong/lantern (front doors). Activated (usually a single-ding) to announce intention to move up after the doors start to open. This will happen when an up hall call front has been entered and the car has reached the floor the call originated from, or if the doors are open and a car call front is entered for a floor above.
<b>CGEUR</b>	CGEU for rear doors Output - Same as CGEU but for the rear gong/lantern.
<b>CGF</b>	Computer Generated Fault Output - Comes on for any computer generated fault.
<b>CHBPO</b>	Car and Hoistway Bypass Output - Active when a door is being bypassed (car gate or hoistway door for both the front and rear sides).
<b>CR01-CR8</b>	Car Card Reader Outputs, front landings. Indicates the associated card reader input has been activated (allowing car call registration to this front landing). Once the call is registered, output will remain active until call completed.

Table 4.7 Spare Outputs Menu Options

Spare Outputs Menu Options	
<b>CR01R-CR8R</b>	Car Card Reader Outputs, rear landings. Indicates the associated card reader input has been activated (allowing car call registration to this rear landing). Once the call is registered, output will remain active until call completed.
<b>CSB</b>	Car Stop Switch Bypass Output - Used to provide redundancy for the in-car stop switch function. Activated during Fire Service Phase I to bypass the in-car stop switch (a similar output is one of the standard outputs). With this second output, failure of one of these devices (stuck in the active mode) will not cause the Stop switch to be bypassed improperly. Redundancy is required by CSA.
<b>CSEO</b>	Code Sequence Enable Output - Active when car is on security and ready to accept the security code. Goes off once the code is accepted or the code entry timer elapses.
<b>CSR</b>	Car Selected to Run Output - Generated when the car is selected to run on Emergency Power phase 2 via the AUTO or EPRUN input.
<b>CTLDOT</b>	Car-to-Lobby Door Open Timer Output - Generated upon completion of the car to lobby function (the car has returned to the lobby landing, the doors have opened, and the CTL door timer has expired).
<b>DBZF</b>	Front Door Buzzer - Active prior to automatic closing of the front doors for the length of time determined by the Door Buzzer Timer.
<b>DBZR</b>	Rear Door Buzzer - Active prior to automatic closing of the rear doors for the length of time determined by the Door Buzzer Timer.
<b>DCFRX</b>	Like DCFX but for rear doors.
<b>DCFX</b>	Door Close Function Auxiliary. Signals the controller to attempt to close the doors. Unlike the standard DCF output on the HC-CTL board, this one is disabled on inspection, Fire phase I, or Fire phase II operation.
<b>DCPRX</b>	Like DCPX but for rear doors.
<b>DCPX</b>	Door Close Power Auxiliary. Unlike the standard DCP output on the HC-CTL board, this one is disabled on inspection, Fire phase I, or Fire phase II operation.
<b>DHEND</b>	Door Hold End Output - Activates five seconds prior to Door Hold Timer expiration.
<b>DHENDR</b>	Door Hold End Output Rear - Activates five seconds prior to Rear Door Hold Timer expiration.
<b>DHO</b>	Door Hold Output - Indicates doors are being held open by the door hold input function. (The DHLDI input is active or the timer associated with the door hold function has not yet elapsed.)
<b>DISB</b>	Distress Buzzer. Activated when the emergency stop switch is pulled or the alarm bell input (ABI) is activated. Pulsates if the SAFH, SAFC, or GOV inputs are low or if the TDISL output is used.
<b>DISL</b>	Distress Light. Activated when the car establishes an extended safety string fault or if the emergency stop switch is pulled or the alarm bell input (ABI) activated.
<b>DISLX</b>	Distress Light Auxiliary. Activated when the car is shut down due to a fault or the MGS or PTI inputs are activated while a car call is latched.
<b>DLOB</b>	Door Left Open Bell Output - Comes on when a call button is pressed and the door has been left open. Used on single button collective and single automatic push button when the hall and car call buttons are connected.
<b>DNO</b>	Down output (Attendant Service) - Used on Attendant Service to indicate that a hall call has been registered below the car and the car has been assigned to answer it. Normally used to light an indicator to alert the attendant that such hall calls exist.
<b>DNS</b>	Down Sense. Active while the car travels in the down direction.
<b>DO1</b>	DO2, DO4, DO8, DO16, D032 - Binary coded P.I. outputs for digital P.I. devices.
<b>DOFRX</b>	Like DOFX but for rear doors.
<b>DOFX</b>	Door Open Function Auxiliary. Signals the door operator to attempt to open the doors. Unlike the standard DOF output on the HC-CTL board, this one is disabled on inspection, Fire phase I, or Fire phase II operation.

Table 4.7 Spare Outputs Menu Options

Spare Outputs Menu Options	
<b>DEIS</b>	Door Enable Inspection Stop Switch - Activated when front door operation is allowed. Deactivated if the elevator is on inspection or Test mode or if the door stop input has been activated. See Spare Input, DSTI.
<b>DEISR</b>	Door Enable Inspection Stop Switch Rear - Activated when rear door operation is allowed. Deactivated if the elevator is on inspection or Test mode or if the door stop input has been activated. See Spare Input, DSTI.
<b>DOORENAB</b>	Door Enable Output. Activated when door operation is permitted. For example, if the car is not on Inspection and not on Test mode.
<b>DSH</b>	Door Time Shortening Output (intermediate) - Generated when a destination car call button is pressed. (Causes door dwell time to shorten if the doors are fully open).
<b>DSHT</b>	Door Time Shortening Front Output (final) - Reflects the status of the DSHT flag. Generated if a destination car call button or the front door close button is pressed.
<b>DSHTR</b>	Door Time Shortening Rear Output (final) - Reflects the status of the DSHTR flag. Generated if a destination car call button or the rear door close button is pressed.
<b>ECRN</b>	Emergency Power Car Run Output - Reflects status of the emergency car run flag associated with emergency power logic. When activated, indicates the car is being prevented from running by emergency power operation logic.
<b>EFG</b>	Egress Floor Gong Output - Activates for 300 milliseconds when the car arrives at the "egress" floor and opens the doors in response to a hall or car call (requires that the egress floor be programmed, <a href="#">See "EGRESS FLOOR ARRIVAL GONG? / MAIN EGRESS FLOOR #"</a> on <a href="#">page 4-25</a> ). Used to activate an audible indicator to inform visually impaired passengers that the elevator has arrived at the main egress floor.
<b>EMSB</b>	Emergency Medical Service Buzzer Output - Comes on as soon as the EMS hall switch is activated (EMSIH) and goes off when the car reaches the EMS floor (Phase 1 return). Used to sound an audible signal in the car to alert passengers that the car is being commanded on EMS service.
<b>EMSIC</b>	Emergency Medical Service Indicator Car Output - Comes on as soon as the EMS hall switch is activated (EMSH). Stays on until the car returns to normal service. Used to activate a visual indicator in the car to alert passengers that the car is on EMS service.
<b>EMSIH</b>	Emergency Medical Service Indicator Hall Output - Comes on when the EMS hall switch is activated (EMSH). Goes off when the in-car switch is activated (EMSC). Enables an indicator informing EMS personnel that the EMS signal was recognized by the control system.
<b>EP1</b>	Emergency Power Phase 1 Output - Activated when Emergency Power is initiated via the EPI input. Stays on until all cars have been recalled to the emergency power landing (sequential lowering, the first phase of emergency power).
<b>EP2</b>	Emergency Power Phase 2 Output - Activated when the system is in the second phase of emergency power (after recall, the normal running of a car on emergency power generators) and remains activated until commercial power is restored.
<b>EQIND</b>	Earthquake indicator output. Generated when the CWI input is activated and the car is out of a door zone on Independent Service
<b>FIR1</b>	Fire Service Phase I output - Activated during Fire Service Phase I Main and Alternate operation.
<b>FLASH</b>	Flash output - Turns ON and OFF at 0.5 second intervals.
<b>FLO</b>	Fan/Light Operation Output - Used to turn OFF the car fan and light. Usually OFF. Turned ON after the Fan/Light Timer elapses. Timer starts when the car becomes inactive.
<b>FRC</b>	Fire Service Phase II Output - Activated when the car is placed on Fire Service Phase II. Active until the elevator has completely transitioned out of fire service phase II operation. Depending on the fire code programmed, may not be until the elevator has completed its return to the recall floor and the doors have fully opened after turning the in-car fire-fighter's switch to the off position.

Table 4.7 Spare Outputs Menu Options

Spare Outputs Menu Options	
<b>FRCT</b>	Fire Service Phase II True Output - Like FRC, active when car is placed on Fire Service Phase II. Remains active after the car is taken off in-car firefighter status and until the car has recalled to the recall landing and the doors are preparing to open.
<b>FRM</b>	Fire Service Phase I Output - Activated when the car is on Main or Alternate Fire Service Phase I. Deactivated when Fire Service Phase II begins.
<b>FSA</b>	Fire Service Alternate Output - Activated when the FRA input is activated by the main fire sensor. Remains active while the car is on Fire Service Phase I.
<b>FSLCX</b>	Fire Service Light COP Auxiliary output. When active, indicates in-car fire service light is active.
<b>FSL LX</b>	Fire Service Light Lobby Auxiliary output. When active, indicates the lobby fire service light is active.
<b>FSM</b>	Fire Service Main Output - Activated by the fire sensor or switch input for Fire Service Main Phase I or II.
<b>FSO</b>	Fire Service On Output - Activated when the car is on Fire Service Phase I or II. Used to activate the visual fire service indicator in the car.
<b>FSVC</b>	True Fire Service Output - Activated when the car is on Fire Service Phase I or II. Used to extinguish the hall position indicators as required by ANSI89 Fire Code.
<b>FWIX</b>	Fire Service Buzzer Auxiliary output.
<b>FWL</b>	Fire Warning Light Output - Used to indicate if the car is on Fire Phase I or II. It will be ON solidly unless machine room or hoistway fire sensors have tripped (FRMR, FRHTW, FRSA, FRSM) (in which case it will flash).
<b>GEDX</b>	Gong Enable Down Auxiliary. Unlike the standard GED output on the HC-CTL board, this one is not active on inspection, Fire phase I, or Fire phase II operation.
<b>GEDRX</b>	Same as GEDX, but for rear doors.
<b>GEUX</b>	Gong Enable Up Auxiliary. Unlike the standard GEU output on the HC-CTL board, this one is not active on inspection, Fire phase I, or Fire phase II operation.
<b>GEURX</b>	Same as GEUX, but for rear doors.
<b>GDO1/2/4/8/16/32</b>	Gray Code digital outputs for Gray Code Digital PI devices.
<b>H</b>	High Speed Output. Active when the elevator is running at high speed. Informational output.
<b>HCP</b>	Hall Call Pushed Output - Active when a hall call button is pressed for the amount of time the button is down.
<b>HCR</b>	Hall Call Reject Output - Reflects the status of the HCR flag which indicates that a car is unable to respond to a hall call (car may be out of service or overloaded).
<b>HCR01-HCR8</b>	Hall Card Reader outputs. Indicates that the associated card reader input has been activated (allowing registration of the hall call). Remains active until the call is extinguished.
<b>HCR01R-HCR8R</b>	Hall Card Reader outputs Rear. Used to indicate that the associated card reader input has been activated (allowing registration of the hall call). Remains active until the call is extinguished.
<b>HDNL</b>	High speed down and not leveling. Informational output.
<b>HDSC</b>	Heat Detector Shutdown Complete Output - Detroit Fire Code. Normally active. When activated, the car stops at the next landing and opens the doors. Once the doors are fully open (DOL=0), the output is turned off, indicating it is okay to shut down the controller and activate machine room sprinklers.
<b>HEO</b>	Hospital Emergency Operation. Flashes when the car is responding to a hospital emergency operation call. Remains flashing until the in-car hospital switch is returned to normal or the time interval that the car must wait for the in-car switch to be turned On expires. <a href="#">Please refer to "HOSPITAL EMERG. OPERATION?" on page 4-45</a>
<b>HLW</b>	Heavy Load Weigher Output - Activated when car load exceeds the heavy load threshold ( <a href="#">see "Load Weigher Thresholds" on page 4-57</a> ) or when the HLI input is activated.

Table 4.7 Spare Outputs Menu Options

Spare Outputs Menu Options	
<b>HOSPH2</b>	Hospital Phase 2. Activated when the car is at the hospital emergency recall floor. Remains active until the hospital in-car switch is turned off or the time interval that the car must wait for the in-car switch to be turned On expires. <a href="#">Please refer to "HOSPITAL EMERG. OPERATION?" on page 4-45.</a>
<b>HSEL</b>	Hospital Emergency Car Select. Reflects the hospital selection status of an elevator. HSEL is the flag that is generated when a car is selected to respond to a hospital emergency call. HSEL is generated when the call is assigned to the car (HSEL actually initiates the return to the hospital call floor) and remains on until the in-car hospital switch is activated or the hospital wait timer expires. <a href="#">Please refer to "HOSPITAL EMERG. OPERATION?" on page 4-45</a>
<b>HUNL</b>	High speed up and not leveling. Informational output.
<b>HWI</b>	Hospital Warning Indicator. This output will remain on when a hospital emergency call is registered in a car on Independent Service. <a href="#">Please refer to "HOSPITAL EMERG. OPERATION?" on page 4-45</a>
<b>INDFRC</b>	Independent Service/Fire Service Phase 2 Output - Used to disconnect hall calls during Fire Independent Service for elevators with either single button collective or single automatic push button operation. <a href="#">Please refer to "OPERATION:" on page 4-13.</a>
<b>INDO</b>	Independent Service Output. Active when the elevator is running on Independent mode. Typically used to drive an indicator light. <a href="#">Please refer to "Independent Service" on page 1-11.</a>
<b>INSP</b>	Inspection. Active when the car is on Inspection operation (any inspection or access mode).
<b>ISRT</b>	In Service and Running Output - Reflects the cars ability to respond to hall calls (the ISRT status). ISRT is active when the car status is such that it can answer hall calls.
<b>ISVF</b>	Flashing In Service Output - Reflects status of the in-service flag (ISV) which indicates that the car is in normal passenger mode of operation. This output will flash if the car times out of service.
<b>ISV</b>	In Service Output - Reflects status of the in-service flag (ISV) which indicates that the car is in normal passenger mode of operation.
<b>IUL</b>	In Use Light output - Activates when the car is in use, e.g., the car is in motion or the doors are open.
<b>LLW</b>	Light Load Weigher Output - Activated when load in the car is less than the threshold set for light load anti- nuisance (see <a href="#">"Load Weigher Thresholds" on page 4-57</a> ) or when the LLI input is activated (see <a href="#">"LIGHT LOAD WEIGHING? / LIGHT LOAD CAR CALL LIMIT" on page 4-43</a> ).
<b>MISV</b>	Mechanically In Service Output - Normally active when the car is running, but turned off when the car is mechanically out of service as indicated by the Safety String (SAF) and Motor Limit Timer (MLT).
<b>MLT</b>	Motor Limit Timer Elapsed Output - Activated if the Motor Limit Timer Elapses or when the EXMLT input is active.
<b>NBZX</b>	Nudging Buzzer Auxiliary output. Unlike the standard NBZ output on the HC-CTL board, this one is not active on inspection, Fire phase I, or Fire phase II operation.
<b>NCD</b>	Emergency Power Return Incomplete Output - Deactivated when car has finished returning on emergency power or when it has been determined that the cannot lower (see <a href="#">"EMERGENCY POWER OPERATION?/EMERGENCY POWER RETURN FLOOR" on page 4-42</a> ).
<b>NDGX</b>	Door Nudging Auxiliary output. Signals the controller to attempt to close the doors at reduced torque. Unlike the standard N1 output on the HC-CTL board, this one is not active on inspection, Fire phase I, or Fire phase II operation.
<b>NDGRX</b>	Same as NDGX, but for rear doors.
<b>OFR</b>	One Floor Run Output - Generated when the car initiates a run. Remains active until the car encounters the first door zone in its movement (active while traversing the first floor height in the direction of travel).



Table 4.7 Spare Outputs Menu Options

Spare Outputs Menu Options	
<b>OFRP</b>	One Floor Run Programmable - Active while making one-floor runs between adjacent floors designated in the Extra Features Menu (see "OFRP BETWEEN FLRS" on page 4-47).
<b>OLW</b>	Overloaded Car Threshold Output - Activated when the overload threshold is reached (see "Load Weigher Thresholds" on page 4-57) or OVL input. The car will remain at the floor with doors open. Typically, when used, a visual or audible indicator alerts passengers that the car is overloaded. Overridden by Fire Service Phase II.
<b>PFGX</b>	Passing Floor Gong Auxiliary output. Unlike the standard PFG output on the HC-CTL board, this one is not active on inspection, Fire phase I, or Fire phase II operation.
<b>PH1</b>	Fire Service Phase 1 Return Complete Output - Indicates the car has successfully completed Fire Service Phase I recall (the car is at the fire recall floor with doors open). Most often used as a signal that it is okay to activate machine room sprinklers.
<b>PI1 - PI8</b>	Position Indicator outputs (discrete). One wire per floor.
<b>PRIFLG</b>	Priority Service Output - Informs the emergency power overlay that the car is on emergency/priority service and should be selected to run. Priority operation includes Hospital Service, EMT Service, Fire Service Phase II, Earthquake Service, and Test Mode.
<b>RCOMP</b>	Rescue Complete. Used with a TAPS unit. When the controller is under TAPS operation, RCOMP will activate (ground) once the car has landed at a floor and cycled doors to let passengers out.
<b>RSTDRV</b>	Reset Drive. Allows the controller to activate the drive reset function.
<b>SAFO</b>	Safety Output. If the car safety string opens, this output activates.
<b>SEC</b>	Security Code Incorrect - When elevator security is on, this output is active for five seconds if an incorrect security code is entered.
<b>SIMPO</b>	Simplex Output - Comes on when the SIMP input is activated or when Simplex Operation is chosen. Used to activate a relay(s) to separate the two hoistway risers.
<b>TESTSWO</b>	Test switch output. Activates when the car is put in Test mode.
<b>TOS</b>	Timed Out of Service Output - Reflects the Timed Out of Service flag. The TOS flag is set if the car does not move within a certain amount of time with either SUA or SDA active.
<b>UPO</b>	Up Output (Attendant Service) - Indicates that a hall call has been registered above the car and the car has been assigned to answer it. Normally used for an indicator light to alert the attendant that such hall calls exist.
<b>UPS</b>	Up Sense. Active while the car travels in the up direction.
<b>WLDI</b>	Wild Operation Indication Output - Generated when the car is in emergency dispatch mode, e.g., if the hall call bus fuse is blown and emergency dispatching is active.
<b>XPI1 - XPI7</b>	Auxiliary Position Indicators 1 through 7. Like the standard PI1 - PI7 outputs except that these are disabled on Inspection or Fire Service Phase I or II.
<b>XSDA</b>	Auxiliary Supervisory Down Arrow - Behaves identically to the standard SDA output except that it is disabled on Inspection and Fire Service Phase I or II.
<b>XSUA</b>	Auxiliary Supervisory Up Arrow - Behaves identically to the standard SUA output except that it is disabled on Inspection or Fire Service Phase I or II.
<b>ZADJ</b>	Zero Adjust - Causes the analog load weigher to perform a zero adjust procedure. Generated once every 31 hours or when the car is idle at the bottom floor for 30 seconds.

## Extra Features Menu Options

- **PI OUTPUT TYPE**
  - Choose 1 WIRE PER FLOOR, BINARY BASE 1, BINARY BASE 0, GRAY CODE 1, or GRAY CODE 0 depending on the inputs required by the position indicator and whether the floor count begins with a zero value or a one value.
- **EMERGENCY POWER OPERATION?/EMERGENCY POWER RETURN FLOOR**
  - If selected, the controller will put the elevator into Emergency Power Operation when it receives an Emergency Power Input (EPI) signal. During Phase 1 of Emergency Power Operation, the car will be moved to the emergency power return floor. In a duplex configuration, each car will be moved to the return floor individually.

During Phase 2 of Emergency Power Operation, if the car Emergency Power Run (EPRUN) input is activated, the car will run normally. Otherwise, the car will remain at the emergency power return floor and will not respond to calls.

For a simplex controller, the car EPRUN input is sometimes connected to a switch so that the input can be turned ON or OFF. For a duplex controller, both car EPRUN inputs are usually connected to a Run Selection switch. The position of this switch determines which car will run during Phase 2 of Emergency Power Operation. Often, there is an AUTO position on the Run Selection switch connected to the AUTO input on both controllers in a duplex. If the AUTO input is activated, one car will be automatically selected to run during Phase 2 of Emergency Power Operation. For example: If one car happens to be out of service when the operation begins, the other car will be automatically selected to run.

If the Emergency Power option is selected, appropriate spare inputs should be configured also. See [“Spare Inputs Menu” on page 4-26](#)

- **LIGHT LOAD WEIGHING? / LIGHT LOAD CAR CALL LIMIT**

- Used only when the Light Load Weigher Input is activated. (See “Spare Inputs Menu” on page 4-26) To program this option:
  - Activate the LLI input.
  - Set LIGHT LOAD WEIGHING? to NO or press S to select the maximum number of car calls registered before all car calls are canceled.
  - If S is pressed, the display will read LIGHT LOAD CAR CALL LIMIT.
  - Press S until the desired number is displayed.

4



Note

Light Load Weighing/Light Load Car Call Limit is an anti-nuisance feature. It is designed to prevent a single person in the car from placing multiple car calls to delay the car.

- **PHOTO EYE ANTI-NUISANCE? / CONSEC STOPS W/O PHE LIMIT**

- When ON, car calls will be canceled if the Photo Eye input has not been activated after a programmed number of consecutive stops. The number of consecutive stops must be programmed before the car calls will cancel. To program this option:
  - Set PHOTO EYE ANTI-NUISANCE? to NO or press S to select the number of consecutive stops.
  - If S is pressed, the display will read CONSEC STOPS W/O PHE LIMIT.
  - Press S until the desired number is displayed.



Note

Photo Eye Anti-Nuisance/Consec Stops w/o PHE Limit is an anti-nuisance feature. It is designed to prevent a single person from remaining in the car and “joy-riding” for multiple calls.

- **MG SHUTDOWN OPERATION?**

- If set to Yes, if a car is idle for a period of time in excess of the MGR timer, it will recall to its parking floor and shut down.

- **CC CARD READER SECURITY?**

- Enables card reader security through a dedicated HC-UIO board. Card reader spare inputs must NOT be used when this is set to Yes. This option requires that a dedicated HC-UIO board be used to function properly.

- **WPIx LANDING? (x = A through H)**

- Wandering Patient Security (Bracelet Security/Infant Abduction Security). When a WPI input is activated, hall calls to the landing and side associated with that input are disabled. If the elevator is already at that landing with doors open, it will be shut down and prevented from leaving that landing. Set the landing number and the side (Front, Rear, or Both) to be disabled when the corresponding spare input (WPIA through WPIH) is activated.

- **ALLOW CAR CALLS ON WP SEC.?**

- Wandering Patient Security (Bracelet Security). If set to Yes, car calls to landings with active WPIx inputs are allowed, otherwise, car calls to those landings are disabled.

- **AUTOMATIC FLOOR STOP OPTION? / AUTOMATIC STOP FLOOR #?**
  - If you want to use this option, set to a specific floor number. The car will automatically stop at that floor on any run that would normally pass the floor.
- **CC CANCEL W/DIR REVERSAL?**
  - Causes all previously registered car calls to be canceled when the car reverses travel direction.
- **CANCEL CAR CALLS BEHIND CAR?**
  - If set to YES and the car has a direction arrow (SUA/SDA), no car calls can be registered behind the current car position. For example: If a car is at the fifth floor moving down, no car calls can be registered for the sixth floor and above.
- **CE ELECTRONICS BOARD?**
  - Informs the controller of the revision level, 1 or 2, of the CE interface board in use.
- **MASSACHUSETTS EMS SERVICE? / EMS SERVICE FLOOR #**
  - Provided in the state of Massachusetts only, this option is key-operated and provides immediate car service for Massachusetts Emergency Medical Service personnel.
- **MASTER SOFTWARE KEY**
  - Standard Security is initiated by the Master Software Key. There are three possible settings: ACTIVATED, ENABLED, or DEACTIVATED.
  - If set to ACTIVATED, Security is initiated.
  - If set to ENABLED, Security is initiated only if the Building Security Input (BSI) is turned On.
  - If set to DEACTIVATED, Security is deactivated regardless of the status of the BSI input.
- **PI TURNED OFF IF NO DEMAND?**
  - When set to YES, allows PI outputs to turn OFF if the car has been inactive for a selected time (from 1 to 10 minutes) as determined by the fan/light timer. [Please refer to “FAN/LIGHT OUTPUT TIMER \(Range: 1.0-10.0 Minutes\)” on page 4-24.](#)

- **HOSPITAL EMERG. OPERATION?**

- When selected, enables Hospital Emergency Operation. Typically, a hospital emergency call switch is installed at each floor where this service is desired.
- If you do not have Hospital Emergency Service Operation, set the option to NO by pressing the S button. Then, press the N push button to exit.
- If you have Hospital Emergency Service Operation, set the option to YES by pressing the S button, then the N button to continue. A landing number display will appear.
- If you want Hospital Emergency Service to this landing, press S to set to Yes. (If you change your mind, press S a second time to go back to No.)
- Press the '+' push button to scroll through available landings. Press N to continue after making settings for a floor.
- If this car has rear doors, the sequence will repeat.
- Press the '+' button to scroll through available landings. The display will continue to present options for each floor. Press N to exit the Hospital Emergency Service option.
  - When a hospital emergency call switch is activated, the hospital emergency call registered light will light at that floor only and the nearest available elevator will respond to the call. All car calls in the selected car will be canceled and any landing calls which had previously been assigned to the car will be transferred to another car if available.
  - If the selected car is traveling away from the hospital emergency call, it will slow down and stop at the nearest floor without opening the doors, reverse direction, and proceed nonstop to the hospital emergency floor.
  - If the selected car is traveling toward the hospital emergency floor, it shall proceed nonstop to that floor.
  - If, at the time of selection, the car is slowing into a floor, it will stop without opening the doors, then travel immediately to the hospital emergency floor.
  - When the car reaches the hospital emergency floor, it will remain with doors open for a timer-determined time. After this interval has expired, if the car has not been placed on in-car Hospital Emergency Service Operation, the car will return to normal service.
  - A hospital emergency key switch in each car operating panel is used to select in-car Hospital Emergency Service Operation. Upon activation of the key switch, the car will be ready to accept a call to any floor and, after the doors are closed, will proceed nonstop to that floor. Returning the key switch to the normal position will restore the car to normal service.
  - The car selected to respond to a hospital emergency call is removed from automatic service and will accept no additional calls, emergency or otherwise, until it completes the hospital emergency function. In duplex installations, if both cars are out of service and unable to answer an emergency call, the hospital emergency call registered light will not illuminate.
  - Four outputs on the first HC-UIO board are used for hospital emergency service calls. Hospital Emergency Operation (HEO) will flash once the car has been selected to respond to a hospital emergency call and will remain flashing until the in-car hospital switch is returned to normal or the time interval that the car must wait for the in-car switch to be turned ON expires. Hospital Emergency Warning Indicator (HWI) will remain steadily ON for a car on Independent Service when the hospital call is registered. Hospital Emergency Select (HSEL) will remain steadily ON, indicating that the car has been selected to answer a hospital call, until the in-car hospital switch is turned ON or the time interval expires. Hospital Emergency Phase 2 (HOSPH2) will remain ON, indicating that the car has arrived at the hospital call floor until the in-car hospital switch is returned to normal or the time interval that the car must wait for the in-car switch to be turned ON expires.

- **FIRE BYPASSES HOSPITAL?**
  - Set to YES if Hospital Service is used for VIP, Priority or Commandeering Service. Set this option to NO if Hospital Service is truly used for Hospital Service.
- **HIGH SPEED DELAY AFTER RUN?**
  - Setting this option inserts a fixed delay (3 seconds) between the completion of a run and the initiation of the next run. Use in applications in which an immediate “stop/start” is undesirable. Under most circumstances, the initiation of a run is delayed by the time required for door operation. In some cases, however, the car may stop and start immediately in the absence of a door operation. For example, a direction reversal upon being assigned a hall call while the car was parking.
- **SINGLE SPEED AC OPTION**
  - Setting this option allows the direction output to clear once the car “steps” into the floor. Typically the direction output is not cleared until the car enters the door zone. However, for applications only requiring one speed, the direction must be cleared prior to door zone to allow the car to arrive at the landing properly.
- **SABBATH OPERATION**
  - If you do not have Sabbath Operation, set this option to NO by pressing the S push button, then press the N push button to exit.
  - If you have Sabbath Operation, set this option to YES by pressing the S push button. Press the N push button to continue. The following will appear:  
“FRONT UP STOP AT FLOOR 1?”
  - If you want the car to service this floor while traveling or initiating travel in the UP direction, press S to select YES. (Pressing S again will set back to NO.)
  - Press + to increment floor value to the next landing. Continue until all desired front UP stops are set to YES.
  - Press N to proceed to the next eligibility map. If there are no walk through doors on this controller, rear eligibility maps will not display. In order, the next eligibility maps are:  
“REAR UP STOP AT FLOOR 1?”  
“FRONT DOWN STOP AT FLOOR 2?”  
“REAR DOWN STOP AT FLOOR 2?”
  - Remember that the + push button increments the floor value to the next landing and that the N push button displays the next eligibility map.
- **LEVELING SENSOR ENABLED/DISABLED**
  - If disabled, LFLT ON, LFLT OFF, and DZ STUCK errors are not generated.
- **KCE DISABLED?**
  - If set to Yes, keyboard command entry is disabled.
- **ANALOG LOAD WEIGHER?**
  - Enables analog load weigher logic and selects the type of learn operation to be performed depending on the type of load weigher installed.
- **IND. BYPASSES SECURITY? YES / NO**
  - Determines if Elevator Security is bypassed when the car is on Independent Service or Test operation (available only when Security is enabled).

- **ATS. BYPASS SECURITY? YES / NO**
  - Determines if Elevator Security is bypassed when the car is on Attendant Service (available only when Security and Attendant Service are enabled).
- **CAR TO FLOOR RETURN FLOOR**
  - Determines the floor to which the car will be returned when the CAR TO FLOOR input is activated (see CTF in Spare Inputs Menu Options).
- **SCROLLING SPEED (NORMAL/FAST/SLOW)**
  - Messages too long to be fully displayed on the LCD are scrolled. This setting determines scrolling speed.
- **OFRP BETWEEN FLRS**
  - Sets the floors between which the OFRP output will be triggered. The One Floor Run Programmable output will then be on while making **one-floor runs** between designated floors.
- **ENABLE FRONT DOB ON SECURITY?**
  - When enabled, front door open button will be enabled for all landings including secured landings. When disabled, door open button is disabled at secured landings once doors have closed.
- **ENABLE REAR DOB ON SECURITY?**
  - When enabled, rear door open button will be enabled for all landings including secured landings. When disabled, door open button is disabled at secured landings once doors have closed.
- **FLR COUNT BELOW FLOOD LEVEL?**
  - PITFLD spare input required. Indicates the number of floors below flood level and thereby sets the flood level. The set number of floors from the bottom of the hoistway will not be serviced when the PITFLD input is active.
- **DISABLE TOP FLRS ON PITFLD**
  - YES/NO - PITFLD spare input required. Prevents the elevator from servicing floors at the top of the hoistway (determined by FLR COUNT BELOW FLOOD LEVEL) when the PITFLD input is active, thereby preventing the counterweight from going into the water.
- **CANCEL BOTH HALL (U/D) CALLS**
  - If set to NO, when the car is servicing a hall call, only the call in the direction of travel is canceled.
  - If set to YES, when the car is servicing a hall call, calls in both up and down directions are canceled.

- **RETAIN CALLS ON CTL / CTF?**
  - No: If Car To Lobby or Car To Floor are activated, the car will first service registered car calls then move to the recall floor. Hall calls will be canceled.
  - Yes: If Car To Lobby or Car To Floor are activated, the car will first service registered car calls then move to the recall floor. Hall calls will be retained and served after the CTL input is deactivated.
- **EARTHQUAKE OPERATION?**
  - Set to Yes if this job has earthquake operation.
- **ANSI EARTHQUAKE/CALIF EARTHQUAKE**
  - Use the S button to select the controlling earthquake code in your location.
  - If CALIF code is selected, you will be asked to indicate whether or not the hoist machine is a “Counterweighted drum machine.” Only jobs that are termed “Counterweighted Drum Machines” should set this option to Yes.

California jobs without a drum machine should select ANSI EQ and set the remaining EQ option parameters as needed.

**Note**

**ANSI Earthquake:** Upon activation of a Seismic switch (EQI input), the elevator in motion will pause, then continue to the nearest available floor at a speed of not more than 150 ft/min (0.76 m/s), open the doors and shut down. If the Counterweight Displacement switch is not activated (CWI), the elevator will be allowed to run at reduced speed on Automatic Operation. If the elevator is in motion when the Counterweight Displacement switch is activated (CWI input) an emergency stop is initiated and then the car will proceed away from the counterweight at reduced speed to the nearest available floor, open the doors and shut down. For this operation the Earthquake Direction Switch input (EDS) must be selected. An elevator may be returned to Normal service by means of the Earthquake Reset button, provided that the Displacement switch (CWI) is no longer activated.

**Note**

**California Earthquake:** When CALIF Earthquake Operation is selected upon activation of a Seismic switch (EQI input), the elevator, if in motion, will pause, then proceed to the nearest available floor at a speed of not more than 150 ft/min (0.76 m/s) open the doors and shut down. When a Counterweight Displacement switch is required and the Counterweight Displacement switch (CWI input) has been activated, the elevator, if in motion, will initiate an emergency stop and proceed away from the counterweight at reduced speed to the nearest available floor, open the doors and shut down. For this operation, the Earthquake Direction Switch (EDS) input must be selected. An elevator may be returned to Normal service using the Earthquake Reset button, provided that the Displacement switch (CWI) is not activated. When Earthquake Operation is needed, the appropriate spare inputs should be selected.



- **EQ SHUTDOWN AT LANDING?**
  - If yes, when the EQI input is activated, the elevator will pause (freeze) momentarily then correct to the nearest landing, stop, open its doors, and shut down.
  - If no, the elevator will react as above but will return to service rather than shutting down.
- **CORRECTION AWAY FROM CW?**
  - If yes, when the EQI input is activated, the elevator will pause (freeze) momentarily, correct to the nearest landing in the direction away from the counterweight, then continue as determined by the EQ SHUTDOWN AT LANDING selection.
  - If no, when the EQI input is activated, the elevator will not consider counterweight location when proceeding as determined by the EQ SHUTDOWN AT LANDING selection.
- **EQ SHUTDOWN PH1 FIRE SERV?**
  - If yes, earthquake shutdown will occur even if the car is on Phase 1, fire return.
- **EQ SHUTDOWN PH2 FIRE SERV?**
  - If yes, earthquake shutdown will occur even if the car is on Phase 2, in-car firefighter service.

## Additional Car Options

- **ETS SWITCHES REQUIRED**
  - Unused parameter. Set to No.
- **HOISTWAY ACCESS? (YES/NO)**
  - Set to YES if job has Hoistway Access operation.
- **TOP ACCESS? (F/R)**
  - Set to the riser in which the hall access switch is located.
- **BOTTOM ACCESS? (F/R)**
  - Set to the riser in which the hall access switch is located.
- **DOOR POSITION MONITORS: (NONE/FRONT/REAR/BOTH)**
  - If job uses door position monitor switches, set accordingly.
- **FRONT DOOR CLOSE LIMIT?**
  - Set to the door close limit signals used by this car. (DCL for door close limit switch. GS and DCAB for gate switch and door closed bottom access. None.)
- **REAR DOOR CLOSE LIMIT?**
  - Set to the door close limit signals used by this car. (DCLR for door close limit switch. GSR and DCABR for gate switch and door closed bottom access. None.)

## F2: External Memory Mode

Access External Memory by placing Function Switch F2 in the Up position (all others down).

External Memory mode is used to view memory addresses in HC-MPU board RAM. The external memory address is denoted by the letters DA (Data Address). Viewing external memory is helpful in troubleshooting. The Computer External Memory Chart Table lists address data digits and meanings.

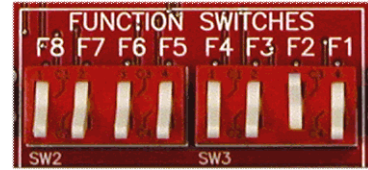

1. Select the address to view. (See following table.)
  - Press N to select an address digit (selected digits blink)
  - Press + or - to change the blinking digit
2. Press S to select the entered address when ready to view contents (or wait about 20 seconds and the selection will appear by itself).

### Example

- The DHLD (Door Hold Open Switch) input is not holding the doors open.
  - From your job prints, you see that DHLD is programmed for the Spare 5 input.
1. Find SP5 in the Computer External Memory Chart ([page 4-51](#)). Note that the Address of SP5 is 02AF and the Position is 4.
  2. Change the address on the display to Address 02AF. (See “F3: System Mode” on [page 4-53](#).) Look at the data bit at position 4 (from the right) to see the state of the input. If the digit is 1, the controller sees the SP5 signal as ON. If the digit is 0, the controller sees the SP5 signal as OFF.

Check the voltage on the SP5 terminal to see whether the problem is in the controller or with outside components.

Table 4.8 Computer External Memory Chart

HALL CALLS							CAR CALLS	
ADD	8	7	6	5	4	3	2	1
0140:	601R/UC1R	601/UC1					101R/CC1R	101/CC1
0141:	602R/UC2R	602/UC2	502R/DC2R	502/DC2			102R/CC2R	102/CC2
0142:	603R/UC3R	603/UC3	503R/DC3R	503/DC3			103R/CC3R	103/CC3
0143:	604R/UC4R	604/UC4	504R/DC4R	504/DC4			104R/CC4R	104/CC4
0144:	605R/UC5R	605/UC5	505R/DC5R	505/DC5			105R/CC5R	105/CC5
0145:	606R/UC6R	606/UC6	506R/DC6R	506/DC6			106R/CC6R	106/CC6
0146:	607R/UC7R	607/UC7	507R/DC7R	507/DC7			107R/CC7R	107/CC7
0147:	608R/UC8R	608/UC8	508R/DC8R	508/DC8			108R/CC8R	108/CC8
0148:	609R/UC9R	609/UC9	509R/DC9R	509/DC9			109R/CC9R	109/CC9
0149:	610R/UC10R	610/UC10	510R/DC10R	510/DC10			110R/CC10R	110/CC10
014A:	611R/UC11R	611/UC11	511R/DC11R	511/DC11			111R/CC11R	111/CC11
014B:	612R/UC12R	612/UC12	512R/DC12R	512/DC12			112R/CC12R	112/CC12
014C:	613R/UC13R	613/UC13	513R/DC13R	513/DC13			113R/CC13R	113/CC13
014D:	614R/UC14R	614/UC14	514R/DC14R	514/DC14			114R/CC14R	114/CC14
014E:	615R/UC15R	615/UC15	515R/DC15R	515/DC15			115R/CC15R	115/CC15
014F:	616R/UC16R	616/UC16	516R/DC16R	516/DC16			116R/CC16R	116/CC16
0150:	617R/UC17R	617/UC17	517R/DC17R	517/DC17			117R/CC17R	117/CC17
0151:	618R/UC18R	618/UC18	518R/DC18R	518/DC18			118R/CC18R	118/CC18
0152:	619R/UC19R	619/UC19	519R/DC19R	519/DC19			119R/CC19R	119/CC19
0153:	620R/UC20R	620/UC20	520R/DC20R	520/DC20			120R/CC20R	120/CC20
0154:	621R/UC21R	621/UC21	521R/DC21R	521/DC21			121R/CC21R	121/CC21
0155:	622R/UC22R	622/UC22	522R/DC22R	522/DC22			122R/CC22R	122/CC22
0156:	623R/UC23R	623/UC23	523R/DC23R	523/DC23			123R/CC23R	123/CC23
0157:	624R/UC24R	624/UC24	524R/DC24R	524/DC24			124R/CC24R	124/CC24
0158:	625R/UC25R	625/UC25	525R/DC25R	525/DC25			125R/CC25R	125/CC25
0159:	626R/UC26R	626/UC26	526R/DC26R	526/DC26			126R/CC26R	126/CC26
015A:	627R/UC27R	627/UC27	527R/DC27R	527/DC27			127R/CC27R	127/CC27
015B:	628R/UC28R	628/UC28	528R/DC28R	528DC28			128R/CC28R	128/CC28
015C:	629R/UC29R	629/UC29	529R/DC29R	529/DC29			129R/CC29R	129/CC29
015D:	630R/UC30R	630/UC30	530R/DC30R	530/DC30			130R/CC30R	130/CC30
015E:	631R/UC31R	631/UC31	531R/DC31R	531/DC31			131R/CC31R	131/CC31
015F:			532R/DC32R	532/DC32			132R/CC32R	132/CC32
SPARE INPUTS *								
ADD	8	7	6	5	4	3	2	1
02AF:	SP8	SP7	SP6	SP5	SP4	SP3	SP2	SP1
02B0:	SP16	SP15	SP14	SP13	SP12	SP11	SP10	SP9
02B1:	SP24	SP23	SP22	SP21	SP20	SP19	SP18	SP17
02B2:	SP32	SP31	SP30	SP29	SP28	SP27	SP26	SP25
02B3:	SP40	SP39	SP38	SP37	SP36	SP35	SP34	SP33
02B4:	SP48	SP47	SP46	SP45	SP44	SP43	SP42	SP41
02B5:							SP50	SP49
* The first 10 spare inputs are located on the HC-CTL board. The remaining spare inputs are located on HC-UIO boards numbered 32 through 36 (8 per board).								
SPARE OUTPUTS **								
ADD	8	7	6	5	4	3	2	1
02EF:	OUT4	OUT3	OUT2	OUT1				
02F0:	OUT12	OUT1	OUT10	OUT9	OUT8	OUT7	OUT6	OUT5
02F1:	OUT20	OUT19	OUT18	OUT17	OUT16	OUT15	OUT14	OUT13
02F2:	OUT28	OUT27	OUT26	OUT25	OUT24	OUT23	OUT22	OUT21
02F3:	OUT36	OUT35	OUT34	OUT33	OUT32	OUT31	OUT30	OUT29
02F4:	OUT44	OUT43	OUT44	OUT45	OUT46	OUT47	OUT48	OUT49
** The first four spare outputs are located on the HC-CTL board. The remaining spare outputs are located on HC-UIO boards numbered 32 through 35 (8 per board).								

**Table 4.9 Hospital Call and Eligibility Memory Chart**

	HOSPITAL CALL ELIGIBILITY				HOSPITAL CALLS				
	OTHER CAR		THIS CAR		ASSIGNED HOSPITAL CALLS		REGISTERED HOSPITAL CALLS		
	REAR	FRONT	REAR	FRONT	REAR	FRONT	REAR	FRONT	
ADD	8	7	6	5	4	3	2	1	
0240:							ECR1	EC1	Floor # 1
0241:							ECR2	EC2	Floor # 2
0242:							ECR3	EC3	Floor # 3
0243:							ECR4	EC4	Floor # 4
0244:							ECR5	EC5	Floor # 5
0245:							ECR6	EC6	Floor # 6
0246:							ECR7	EC7	Floor # 7
0247:							ECR8	EC8	Floor # 8
0248:							ECR9	EC9	Floor # 9
0249:							ECR10	EC10	Floor # 10
024A:							ECR11	EC11	Floor # 11
024B:							ECR12	EC12	Floor # 12
024C:							ECR13	EC13	Floor # 13
024D:							ECR14	EC14	Floor # 14
024E:							ECR15	EC15	Floor # 15
024F:							ECR16	EC16	Floor # 16
0250:							ECR17	EC17	Floor # 17
0251:							ECR18	EC18	Floor # 18
0252:							ECR19	EC19	Floor # 19
0253:							ECR20	EC20	Floor # 20
0254:							ECR21	EC21	Floor # 21
0255:							ECR22	EC22	Floor # 22
0256:							ECR23	EC23	Floor # 23
0257:							ECR24	EC24	Floor # 24
0258:							ECR25	EC25	Floor # 25
0259:							ECR26	EC26	Floor # 26
025A:							ECR27	EC27	Floor # 27
025B:							ECR28	EC28	Floor # 28
025C:							ECR29	EC29	Floor # 29
025D:							ECR30	EC30	Floor # 30
025E:							ECR31	EC31	Floor # 31
025F:							ECR32	EC32	Floor # 32

**Legend for Table 4.8**

	Registered hospital calls for the floor opening. 1 = call is registered 0 = call is not registered
	Assigned hospital calls for the floor opening 1 = Call is assigned 0 = Call is not assigned
	The car is eligible for hospital Emergency Service Operation for the floor opening. 1 = Hospital emergency call can be entered for the floor opening 0 = Hospital emergency call cannot be entered for the floor opening

## F3: System Mode

System mode allows the user to change certain system-wide options that do not require the car to be on Inspection. To enter System mode:

- Move the F3 switch to the up position (all others down).
- Press N to select the desired System Mode item.
  - Building Security Menu (see [page 4-53](#))
  - Passcode Request Menu (see [page 4-56](#))
  - Load Weigher Thresholds (see [page 4-57](#))
  - Analog Load Weigher Learn Function (see [page 4-57](#))
  - Controller System Menu - real time speed and position indication (see [page 4-49](#))

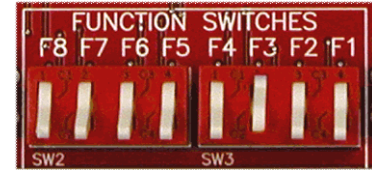

4

## Building Security Menu

Elevator Security is used to limit access to specified floors to passengers with a valid security code. The Security code for each floor is a sequence of button presses on the car operating panel and may consist of from one to eight “characters”. Any floor with a programmed security code is a secured floor when Security is ON. Security is turned ON or OFF by the controller Building Security Input (BSI) in combination with the Master Software Key parameter in the Extra Features Menu (Program mode). There are three possible settings for the Master Software Key: ACTIVATED, ENABLED, and DEACTIVATED:

- If set to ACTIVATED, Security is ON.
- If set to ENABLED, Security is ON when the BSI input is turned ON.
- If set to DEACTIVATED, Security is OFF regardless of the status of BSI.

To find the BSI input, refer to the job prints. When Security is ON, car calls are registered only if the call is not to a secured floor or the call is to a secured floor and the security code is correctly entered within 10 seconds.

### Viewing The Building Security Menu

1. Place the F3 switch in the up position (all other switches down). The following display appears:
2. Press the N push button. The following display appears:

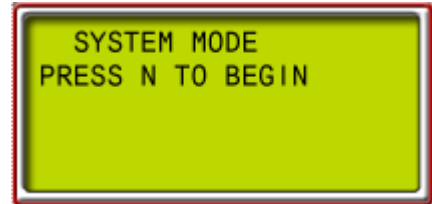

### Programming And Viewing The Security Codes

1. Press S to start changing or viewing Security codes. If no code has been programmed, the computer displays NO CODE PROGRAMMED for that particular floor.  
  
Press S again to start programming the Security code.



If a code has already been programmed, the computer displays the security code with the floor number blinking.

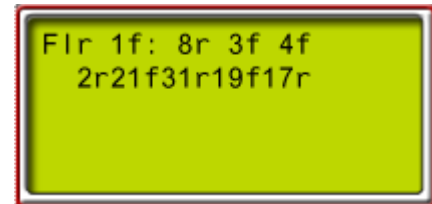

2. Press + to increment or – to decrement floor number.
3. Press S to move to the first character (COP button to be pressed) of the security code. Use + or – to change value.
4. Repeat until the desired number of characters are programmed (maximum 8). If any character is left blank, or after all eight characters have been programmed, the S button will return the cursor to the floor number.
5. Continue to program Security codes for all floors. You may exit the Building Security Menu at any time by pressing the N button. When N is pressed, the LCD will display:
6. Press S to exit or N to return to the previous display. If S is pressed, the following will appear (if changes have been made):.
7. Press S to save or N to exit without saving (previous codes will remain in effect if changes are not saved).

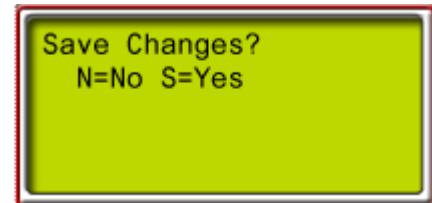
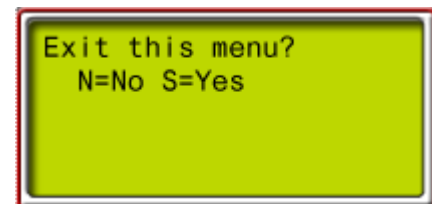

## Controller System Menu

This menu provides real time position and speed information and allows you to bypass faults in both Automatic and Inspection operating modes when required for system tests. It also provides access to a data trap required by ASME A17.2000 code.

- **AUTOMATIC MODE FAULT BYPASS. JUMPER MUST BE INSTALLED TO ACTIVATE.**
  - In order to activate fault bypass during normal, automatic mode operation, a jumper must also be installed on Fault Reset jumper J1 on the CTL board. When faults are bypassed, they will continue to be displayed but the controller will not react to them.
- **INSPECTION MODE FAULT BYPASS. JUMPER MUST BE INSTALLED TO ACTIVATE.**
  - In order to activate fault bypass during inspection mode operation, a jumper must also be installed on Fault Reset jumper J1 on the CTL board. When faults are bypassed, they will continue to be displayed but the controller will not react to them.
- **ELGO A: 0mm**  
**ELGO B: 0mm**
  - Displays the raw position reported by the two (A and B) sensors in the ELGO landing system sensor head. Useful to check functionality and travel direction. The displayed positions will be about 160 mm or 240mm apart depending upon the Elgo system used.
- **POSTN: 0.0 IN**  
**SPEED: 0 FPM**
  - Displays current car position in inches above the bottom floor level position and the car speed in feet per minute.



## Passcode Request Menu

The Passcode Request Operation can be used to require password entry to run the car on any mode of operation other than **Inspection**.



If a passcode has not been programmed, the Passcode Request Menu will not appear.

If a passcode has been programmed, the LCD screen will flash the “PASSCODE REQUEST” message when Passcode Request Operation is activated.

In order to clear or set the Passcode Request Operation, the controller must first be placed in System Mode (F3 up, all others down).

- Press N when the display reads “BUILDING SECURITY MENU.” The Passcode Request Menu will appear:



### Entering the Passcode

Press S. If Passcode Request Operation is activated, the following screen appears:

The first character of the passcode will blink. Use + - to scroll through numbers 0-9 and letters A-Z for each character. Press N to advance to the next character position.

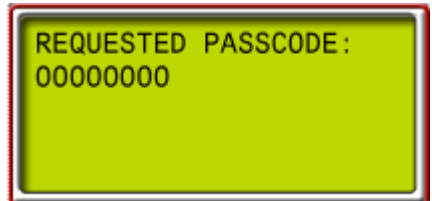

Press S to verify the entry is correct. If it is not, the following screen will appear:

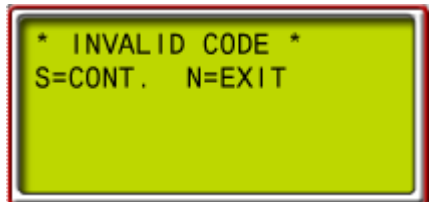

Press S to try again. Press N to exit.

If the correct passcode was entered, the following screen appears:

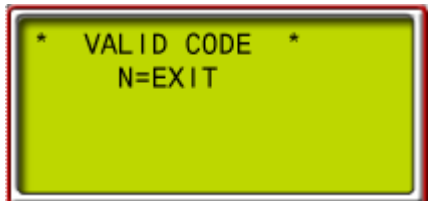

Press N to exit. The car may now be run on Normal operation mode.



**Activating the Passcode** With the Passcode Request menu displayed, press S. If Passcode Request Operation is not activated, the following display appears:

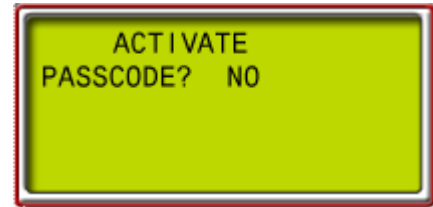

- Press S to toggle from “NO” to “YES.”
- Press N with “YES” displayed to activate Passcode Request Operation and exit this screen. With Passcode Request Operation activated, the passcode must be entered in order to run the car on any mode of operation other than Inspection.
- Press N with “NO” displayed to exit with Passcode Request inactive.

4

## Load Weigher Thresholds

Analog load weighers provide a signal that corresponds to the load in the car. This value is used to make dispatching decisions. Load thresholds are user-programmable.

- **LIGHT LOAD WEIGHER (LLW)**
  - Used to define the load at which the number of car calls will be limited (anti-nuisance). If the programmed number of car calls is exceeded, all car calls are canceled.  
Example: LLW=20%. If the load in the car is less than 20%, the computer will only allow a certain number of car calls to be registered as defined by the parameter LIGHT LOAD WEIGHING? / LIGHT LOAD CAR CALL LIMIT in the EXTRA FEATURES MENU OPTIONS. If the limit is set to a value of three, the computer will only allow three calls to be registered if the load is less than 20%. If a fourth call is registered, all car calls will be canceled.
- **DISPATCH LOAD WEIGHER (DLW)**
  - Used to define the load at which the lobby landing door timer will be reduced so that the doors may begin closing sooner, limiting the number of boarders. This threshold should be set to a value (defined in many specifications as 60%) at which it is appropriate to initiate the process of moving the car out of the lobby.
- **HEAVY LOAD WEIGHER (HLW)**
  - Used to define the load value at which additional hall calls should be bypassed to avoid overloading the elevator.
- **OVERLOAD WEIGHER (OLW)**
  - Used to define the load at which it is considered unsafe to move the elevator. When this threshold is exceeded, the car will remain at the floor with doors open and typically sound a buzzer or otherwise indicate that the car is overloaded.

## Adjusting Thresholds

Typical values for load thresholds are shown below. Thresholds are user-adjustable.

### To adjust thresholds

1. Enter SYSTEM mode (F3 up, all others down).
2. Press N until LOAD WEIGHER THRESHOLDS appears on the LCD.
3. Press S to display the load threshold you wish to set.
4. The value shown is the current threshold value is expressed as a percentage of the full load value (see the explanations above). Press + or - to adjust a value. If a value is set to 0%, that load weigher function is disabled.
5. Press S to select the next threshold to adjust or press N to exit.
6. Place the F3 switch in the down position to exit SYSTEM mode when finished.

If an analog load weigher is used, the Analog Load Weigher Learn Function must be performed before the load weigher system will perform properly.

## Analog Load Weigher Learn Function

With the isolated platform load weigher from MCE, the system simply learns the reference values of the empty and fully loaded car weight at any floor. With the crosshead deflection load weigher from K-Tech or the rope stress load weigher from EMCO (using the 0 - 10V analog output), the system must learn the values at each floor because the load varies with car position due to the changing proportion of traveling cable hanging beneath the car and the position of the compensation cables.

The Analog Load Weigher Learn Function is performed as follows:

1. Move the empty car to the floor where the test weights are located. It is best to have one person in the machine room and another person at the floor to load the weights.
2. Place the car on Independent Service operation.
3. Place the F3 switch in the up position and press N to select the Analog Load Weigher Learn Function (scrolling message is displayed)
  - ANALOG LOAD WEIGHER LEARN FUNCTION. PRESS S TO START
4. Press S to start. The computer responds with one of two scrolling messages:
  - CAR NOT READY TO LEARN, MUST BE ON INDEPENDENT SERVICE
5. Verify that the car has been placed on Independent Service.
  - READY TO LEARN EMPTY CAR VALUES? PRESS S TO START
6. If the empty car values have already been learned and you want to learn full car values, press N and go to step 9. To begin learning empty car values, press S. The computer displays the message:
  - LEARNING EMPTY CAR VALUES. PRESS N TO ABORT
7. If the Extra Features Menu Option "Analog Load Weigher?" is set to K-TECH or EMCO, the car will move to the bottom floor, record the empty car value and then move up, stopping at each floor to record the empty car value. When the top floor has been reached, the car will move back to the floor at which the Analog Load Weigher Learn Function was begun and the computer will display the scrolling message:
  - EMPTY CAR LEARN PROCESS COMPLETED. PRESS S TO CONT.

8. If the Extra Features Menu Option “Analog Load Weigher?” is set to MCE, the car will learn the empty car value once and display:
  - EMPTY CAR LEARN PROCESS COMPLETED. PRESS S TO CONT.
9. Press S. The computer displays the scrolling message:
  - READY TO LEARN FULL CAR VALUES? PRESS S TO START.
10. Place the full load test weights in the car and press S to begin learning full car values. The computer displays the message:
  - LEARNING FULL CAR VALUES. PRESS N TO ABORT.
11. If the Extra Features Menu Option “Analog Load Weigher?” is set to K-TECH or EMCO, the car will move to the bottom floor, record the full car value and then move up, stopping at each floor to record the full car value. When the top floor has been reached, the car will move back to the floor at which the Analog Load Weigher Learn Function was begun and the computer will display the scrolling message:
  - FULL CAR LEARN PROCESS COMPLETED. PRESS S TO CONT.
12. If the Extra Features Menu Option “Analog Load Weigher?” is set to MCE, the car will learn the full car value once and then display the message:
  - FULL CAR LEARN PROCESS COMPLETED. PRESS S TO CONT.
13. Press S. Place the F3 in the down position and take the car off Independent service.
14. To verify that the Load Weigher Learn Function has been performed successfully, place the F8 switch in the up position. With the test weights in the car, the following should be displayed:
  - CURRENT LOAD = 100%
15. If the Load Weigher Learn Function has not been performed successfully, the following will be displayed:
  - CURRENT LOAD = NOT LEARNED

The Load Weigher Learn Function (empty or full values) may be aborted at any time by pressing the N button. The computer will display the message:

- LEARN PROCESS ABORTED... PRESS S TO CONT.
1. When the S button is pressed the computer displays the scrolling message:
    - ANALOG LOAD WEIGHER LEARN FUNCTION. PRESS S TO START
  2. At this point, you may exit System Mode by placing the F3 switch in the down position, or you may re-start the learn function by moving the car back to the floor where the test weights are located and pressing S to start (go to step 4).
  3. If the empty car values have been learned but the full load learn function was aborted, you need not re-learn the empty car values. Instead, when the message READY TO LEARN EMPTY CAR VALUES is displayed, press N. The computer will display:
    - READY TO LEARN FULL CAR VALUES? PRESS S TO START.
  4. Press S to begin learning full car values (go to step 10).

## F4: Messages and Floor Labels

To access: F4 switch up; all others down.

- **Modify Floor Labels**
  - FLOOR LABEL FOR LANDING 01: \_ \_ \_
  - Use + or - keys to change landing
  - Use S key to move to first label field
  - Use + or - keys to change field value
  - Use S key to move to next field
  - Repeat
- **Modify Message Labels**
  - Per landing/per message, use operating keys as above to set a three-character message to be displayed at each landing for the associated message.
- **Initialize all Labels**
  - DEFAULT LABELS [S] - Yes [N] - No
  - Use this function to initialize all labels to factory defaults.
  - If you do not wish to complete the command, press and hold -, then press N to exit.

Figure 4.2 PI Entry Process

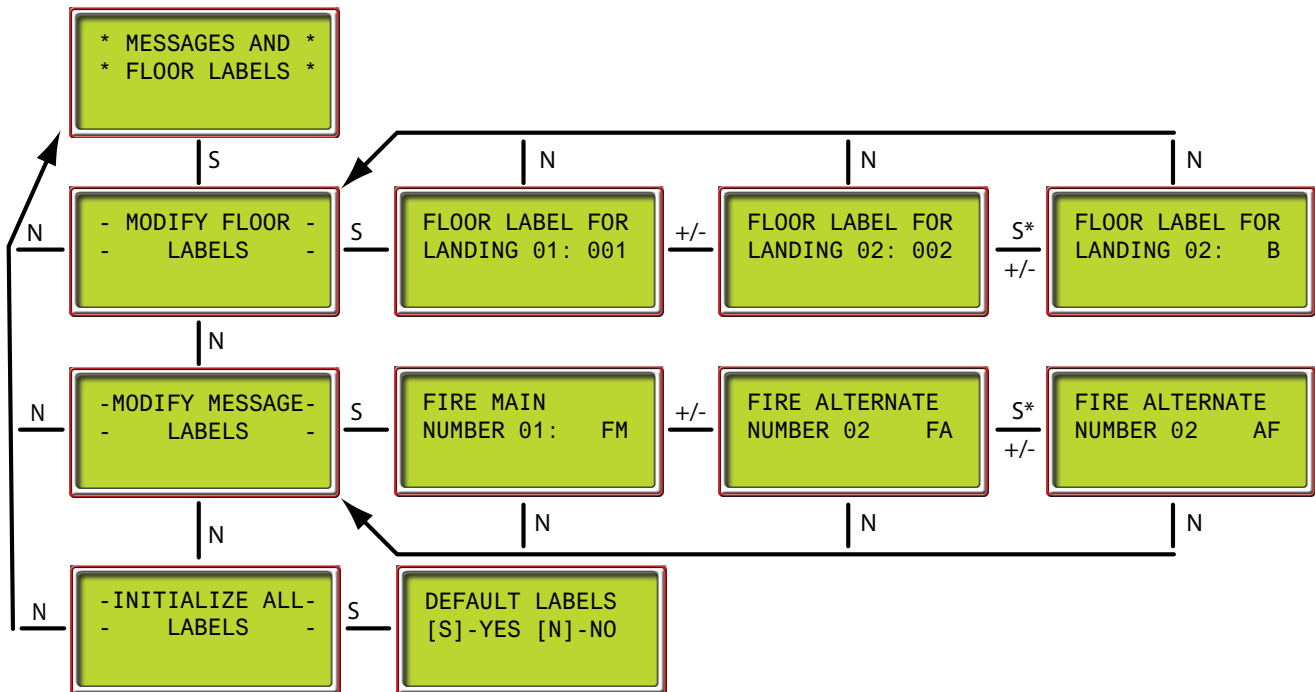

Spaces for three characters (three character display) are provided. If the display has only two characters, use the two right most spaces (ones and tens place) and leave the left most space (hundreds place) blank.

## F5 Menu

The F5 switch provides access the three menus:

- **Controller Utilities Menu**
  - A way to register front and rear car calls from the controller or the hand-held device
  - Allows you to view and set date and time for controller time stamping
  - View and/or clear the event log
  - Default TC-MPI parameters
  - Displays position/speed related diagnostics (TC-MPI Diagnostics)
  - View inputs and outputs of system MC-CPI control panel serial interface boards
- **Monitoring & Reporting**
  - Set up and view Ethernet communications for monitoring applications
- **Terminal Limit Utilities Menu**
  - Learn limit switch positions
- **FCL Brake Unit Utilities Menu**
  - FCL Diagnostic Menu
  - FCL Power Data Menu
  - Default TC-FCL Parameters
  - FCL Adjustment Menu

To view:

F5 up (all others down). Press N to advance through menus. Press S to select a menu.

4

## Controller Utilities

### Car Call Registration

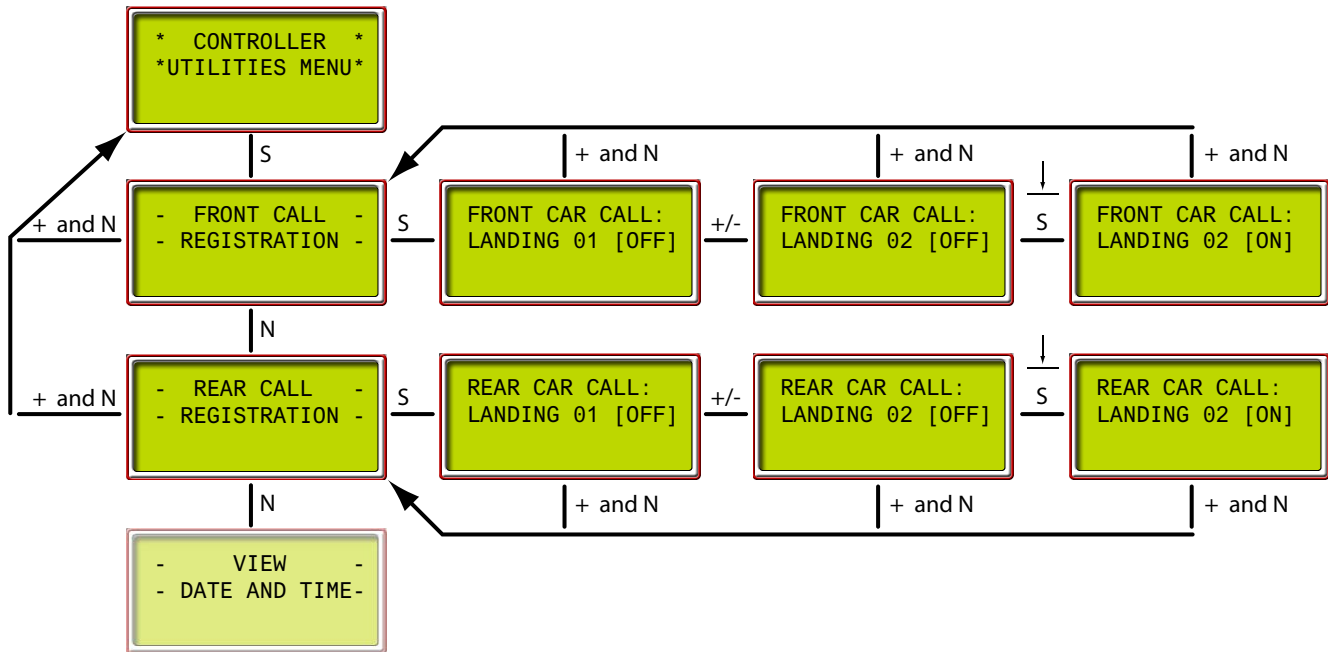

- +/- to increment or decrement floor numbers
- Press and momentarily hold S to register calls; displays [ON] while held
- Press + and N together to back out of the current display

### Date/Time, View / Adjust

1. Press S until Controller Date and Time is displayed.
2. N to select day/month/year/hours/minutes/seconds.
3. + or - to set.

### View Event Log

The event log tracks the last 100 events.

1. Press S to select the log.

The first event will be displayed on the top line of the display along with the time and date on the bottom line.

2. Press + to move to the next event.
3. Continue to examine all events.

### Clear Event Log

This allows you to clear the events from the event log.

1. Press S to select the clear function.

A prompt will appear allowing you to back out without clearing events (Yes/No).

2. To clear the log press the S button when prompted.

A message will appear notifying you that all events have been cleared.

### Default TC-MPI Parameters

This selection allows you to default the TC-MPI board to factory defaults.

1. Press S to select.
2. Press S to confirm or N to back out.
3. Message MPI Parameters are defaulted will be displayed.

Use the F7 function to upload the defaulted parameters from the TC-MPI ([F7: Parameters Adjust on page 4-100](#)).

### MPI Diagnostic Menu

These diagnostics allow you to view car motion parameters (speed/distance) as the car moves through the hoistway. This information in turn will help you make ride adjustments or troubleshoot ride issues.

The initial screen will show either METRIC or ENGLISH units.

1. To switch between Metric or English units, press N once. (Pressing N a second time will back you out of the menu.)

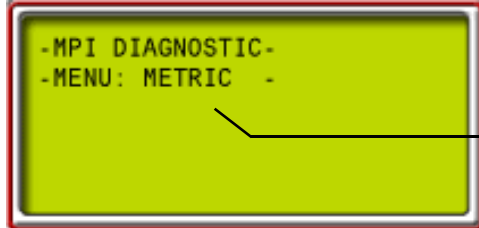

Metric or English units may be displayed

2. With the desired measuring units displayed, press S to begin diagnostics display.

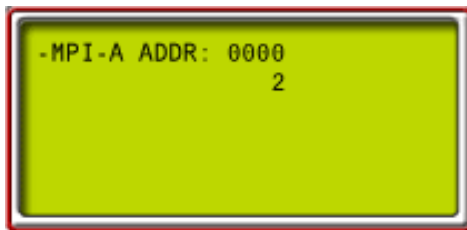

The initial display is for MPI-A (Processor A on the MPI board), address zero. This address displays the number of floors served — two in this example.

3. To select the parameter to display, use the S button to move between digits (processor A, B, or C or address positions 0000 - 9999) — the selected digit will flash — and the Plus (+) or Minus (-) buttons to change the value of the selected digit.

For example, to display to speed recorded by MPI Processor B the last time the car passed the Down Normal Terminal switch S2, select MPI-B, address 0019.

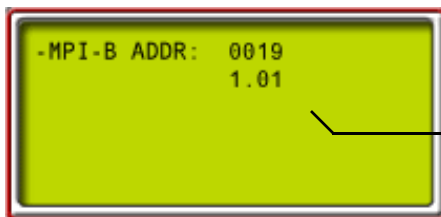

1.01 meters per second (Metric)  
 or  
 200 feet per minute (English)

- To find the address of the data you want to display, check the following tables.
  - MPI-A and MPI-B independently collect information from the Elgo positioning sensors. The information they display per address should usually match. However, if you are displaying position information, you need to factor in that the sensors they monitor in the Elgo sensor head are 160 mm (6.3 inches) or 230 mm (9.05 inches) apart.
  - MPI-C collects information from the drive/motor/encoder.

As soon as you select an address, the information stored there is displayed.



**MPI-A Diagnostics**

The following diagnostic information can be viewed for Safety Processor A on the TC-MPI Motion Processor Interface board.

**Table 4.10 MPI-A Diagnostics**

Address	Item	Notes
0	Front openings	
1	Rear openings	
2	Floors	
3	Bottom floor	
4	Top floor	
5	Bottom landing	
6	Top landing	
7	Bottom position	
8	Top position	
9	Raw position	
10	Absolute position	
11	Relative position	
12	Delta Distance	
13	Offset distance	
14	Delta position errors	
15	Delta speed errors	
16	Processed speed feedback	
17	Raw speed feedback	
18	Speed @ leveling over-speed fault	
19	Speed @ inspection over-speed fault	
20	Speed @ contract over-speed fault	
21	Runtime speed @ DETS	
22	Runtime speed @ DNTS1	
23	Runtime speed @ DNTS2	
24	Runtime speed @ DNTS3	
25	Runtime speed @ DNTS4	
26	Runtime speed @ DNTS5	
27	Runtime speed @ UETS	
28	Runtime speed @ UNTS1	
29	Runtime speed @ UNTS2	
30	Runtime speed @ UNTS3	
31	Runtime speed @ UNTS4	
32	Runtime speed @ UNTS5	
33	Speed @ DETS over-speed fault	
34	Speed @ DNTS1 over-speed fault	
35	Speed @ DNTS2 over-speed fault	
36	Speed @ DNTS3 over-speed fault	
37	Speed @ DNTS4 over-speed fault	
38	Speed @ DNTS5 over-speed fault	
39	Speed @ UETS over-speed fault	

**Table 4.10 MPI-A Diagnostics**

Address	Item	Notes
40	Speed @ UNTS1 over-speed fault	
41	Speed @ UNTS2 over-speed fault	
42	Speed @ UNTS3 over-speed fault	
43	Speed @ UNTS4 over-speed fault	
44	Speed @ UNTS5 over-speed fault	
45	Runtime distance @ DETS	
46	Runtime distance @ DNTS1	
47	Runtime distance @ DNTS2	
48	Runtime distance @ DNTS3	
94	Runtime distance @ DNTS4	
50	Runtime distance @ DNTS5	
51	Runtime distance @ UETS	
52	Runtime distance @ UNTS1	
53	Runtime distance @ UNTS2	
54	Runtime distance @ UNTS3	
55	Runtime distance @ UNTS4	
56	Runtime distance @ UNTS5	
57	Distance @ DETS position fault	
58	Distance @ DNTS1 position fault	
59	Distance @ DNTS2 position fault	
60	Distance @ DNTS3 position fault	
61	Distance @ DNTS4 position fault	
62	Distance @ DNTS5 position fault	
63	Distance @ UETS position fault	
64	Distance @ UNTS1 position fault	
65	Distance @ UNTS2 position fault	
66	Distance @ UNTS3 position fault	
67	Distance @ UNTS4 position fault	
68	Distance @ UNTS5 position fault	
69	DETS type	
70	DTS1 type	
71	DNTS2 type	
72	DNTS3 type	
73	DNTS4 type	
74	DNTS5 type	
75	UETS type	
76	UNTS1 type	
77	UNTS2 type	
78	UNTS3 type	
79	UNTS4 type	
80	UNTS5 type	
81	Successful runs	

**Table 4.10 MPI-A Diagnostics**

Address	Item	Notes
82	Fault runs	
83	Floor zone	
84	Position bypass count	
85	Position pass count	
86	System position count	
87	Absolute position count	
88	Position lower sequence	
89	Position upper sequence	
90	Position lower value	
91	Position upper value	
92	Landing code	
93	At landing	
95	Near floor	
100	Port A inputs: (n/a)	
101	Port B inputs: 01 = TPM 02 = TBR 03 = PMP 04 = BRP 05 = UETS 06 = DETS 07 = SPI1 08 = SPI2 09 = EGOK 10 = RGR1 11 = RGR2 12 = RGOK 13 = EBPS 14 = EB RST 15 = SPI3 16 = SPI4	
102	Port C inputs: 01 = PMDD 02 = (n/a) 03 = (n/a) 04 = (n/a) 05 = (n/a) 06 = (n/a) 07 = (n/a) 08 = (n/a) 09 = (n/a) 10 = (n/a) 11 = (n/a) 12 = (n/a) 13 = (n/a) 14 = (n/a) 15 = (n/a) 16 = (n/a)	
103	Port D inputs: (n/a)	

**Table 4.10 MPI-A Diagnostics**

Address	Item	Notes
104	Port E inputs: 01 = SW2-1 02 = SW2-2 03 = SW2-3 04 = SW2-4 05 = (n/a) 06 = (n/a) 07 = (n/a) 08 = (n/a) 09 = (n/a) 10 = (n/a) 11 = (n/a) 12 = (n/a) 13 = (n/a) 14 = (n/a) 15 = (n/a) 16 = (n/a)	
105	Port F inputs: (n/a)	
106	Port G inputs: (n/a)	
110	Port A outputs: 01 = DIA6A 02 = DIA5A 03 = DIA4A 04 = DIA3A 05 = DIA2A 06 = DIA1A 07 = (n/a) 08 = (n/a) 09 = (n/a) 10 = SPA ON LED 11 = UNINTENDED MOTION LED 12 = (n/a) 13 = (n/a) 14 = (n/a) 15 = (n/a) 16 = (n/a)	
111	Port B outputs: (n/a)	

Table 4.10 MPI-A Diagnostics

Address	Item	Notes
112	Port C outputs: 01 = (n/a) 02 = (n/a) 03 = (n/a) 04 = (n/a) 05 = (n/a) 06 = (n/a) 07 = (n/a) 08 = (n/a) 09 = (n/a) 10 = (n/a) 11 = (n/a) 12 = (n/a) 13 = (n/a) 14 = (n/a) 15 = (n/a) 16 = OVERSPEED LED	
113	Port D outputs: 01 = DZF 02 = DZR 03 = PME 04 = BRE 05 = DRE 06 = EB1 07 = EB4 08 = (n/a) 09 = (n/a) 10 = (n/a) 11 = (n/a) 12 = (n/a) 13 = (n/a) 14 = (n/a) 15 = (n/a) 16 = (n/a)	
114	Port E outputs: (n/a)	
115	Port F outputs: (n/a)	
116	Port G outputs: 01 = (n/a) 02 = (n/a) 03 = DIA7A 04 = DIA8A 05 = (n/a) 06 = (n/a) 07 = (n/a) 08 = (n/a) 09 = (n/a) 10 = (n/a) 11 = (n/a) 12 = (n/a) 13 = (n/a) 14 = (n/a) 15 = (n/a) 16 = (n/a)	

**Table 4.10 MPI-A Diagnostics**

Address	Item	Notes
200	Faults (01 - 16): 01 = Maximum position offset fault 02 = Minimum position offset fault 03 = Landing system fault (emergency brake dropped) 04 = Landing system communication loss fault 05 = Unintended motion 06 = SPC is offline 07 = SPB is offline 08 = (n/a) 09 = Inspection over-speed 10 = Contract over-speed 11 = Leveling over-speed 12 = EEPROM CRC error 13 = EEPROM device error 14 = ETS shutdown 15 = UETS over-speed 16 = UETS position error	
201	Faults (17 - 32): 01 = DETS over-speed 02 = DETS position error 03 = Emergency brake cycle test fault 04 = PMDD contactor pick monitor fault 05 = PMDD contactor drop monitor fault 06 = 2L bus monitor fault 07 = RGOK fault (emergency brake dropped) 08 = Actual and requested direction mismatch 09 = Excessive faults shutdown 10 = 2MV bus monitor fault 11 = EBPS monitor fault 12 = UNTS-L over-speed 13 = UNTS-H over-speed 14 = UNTS position error 15 = DNTS-L over-speed 16 = DNTS-H over-speed	
202	Faults (33 - 48): 01 = DNTS position error 02 = RGOK monitor fault 03 = (n/a) 04 = (n/a) 05 = (n/a) 06 = (n/a) 07 = (n/a) 08 = (n/a) 09 = (n/a) 10 = (n/a) 11 = (n/a) 12 = (n/a) 13 = (n/a) 14 = (n/a) 15 = (n/a) 16 = (n/a)	

Table 4.10 MPI-A Diagnostics

Address	Item	Notes
203	Faults (49 - 64): (n/a)	
300	16 = BRE (MPI-A) 15 = DRE (MPI-A) 14 = PME (MPI-A) 13 = DRE (MPI-C) 12 = BRE (MPI-C) 11 = PME (MPI-C) 10 = (n/a) 09 = (n/a) 08 = (n/a) 07 = (n/a) 06 = (n/a) 05 = (n/a) 04 = (n/a) 03 = Danger 02 = Fault 01 = Ready	
301	16 = (n/a) 15 = (n/a) 14 = (n/a) 13 = Up slowdown 12 = Down slowdown 11 = Up direction limit 10 = Down direction limit 09 = Front level up 08 = Front door zone 07 = Front level down 06 = Rear level up 05 = Rear door zone 04 = Rear level down 03 = High speed 02 = Up 01 = Down	
302	16 = (n/a) 15 = (n/a) 14 = (n/a) 13 = (n/a) 12 = (n/a) 11 = (n/a) 10 = Up slowdown 09 = Down slowdown 08 = Near top 07 = Near bottom 06 = Up direction limit 05 = Down direction limit 04 = Front door zone 03 = Rear door zone 02 = Up 01 = Down	

4

**Table 4.10 MPI-A Diagnostics**

Address	Item	Notes
303	16 = UETS status 15 = UTS1 status 14 = UNTS2 status 13 = UNTS3 status 12 = UNTS4 status 11 = UNTS5 status 10 = DETS status 09 = DTS1 status 08 = DNTS2 status 07 = DNTS3 status 06 = DNTS4 status 05 = DNTS5 status 04 = Front door zone 03 = Rear door zone 02 = Up 01 = Down	
304	16 = In rear floor zone 15 = In front floor zone 14 = Emergency brake: check relay fault 13 = Emergency brake: floor unintended motion 12 = Emergency brake: door unintended motion 11 = Emergency brake: governor over-speed 10 = Zone failure 09 = Rear gate failure 08 = Rear lock failure 07 = Front gate failure 06 = Front lock failure 05 = Emergency brake armed 04 = Rear door open 03 = Front door open 02 = In rear door zone 01 = In front door zone	
400	Down distance @ 100% of contract speed	
401	Down distance @ 90% of contract speed	
402	Down distance @ 80% of contract speed	
403	Down distance @ 70% of contract speed	
404	Down distance @ 60% of contract speed	
405	Down distance @ 50% of contract speed	
406	Down distance @ 40% of contract speed	
407	Down distance @ 30% of contract speed	
408	Down distance @ 20% of contract speed	
409	Down distance @ 10% of contract speed	
410	Up distance @ 100% of contract speed	
411	Up distance @ 90% of contract speed	
412	Up distance @ 80% of contract speed	
413	Up distance @ 70% of contract speed	



**Table 4.10 MPI-A Diagnostics**

Address	Item	Notes
414	Up distance @ 60% of contract speed	
415	Up distance @ 50% of contract speed	
416	Up distance @ 40% of contract speed	
417	Up distance @ 30% of contract speed	
418	Up distance @ 20% of contract speed	
419	Up distance @ 10% of contract speed	
420	Upper Elgo sensor position in m/in	Example: 1.019M. Processed raw position for MPI-B and MPI-C. Median for MPI-A.
421	Lower Elgo sensor position in m/in	Example: 0.859M. Processed raw position for MPI-A and MPI-C. Median for MPI-B.
422	Median Elgo sensor position in m/in	Upper sensor position for MPI-A, lower for MPI-B
423	Elgo sensor offset in m/in	Distance between upper and lower sensors. About +160mm for short Elgo sensor head and +240mm for long sensor head.
900	Software ID	
901	Software Revision	
902	Firmware Revision	
903	Hardware Revision	

**MPI-B Diagnostics**

The following diagnostic information can be viewed for Safety Processor B on the TC-MPI Motion Processor Interface board.

**Table 4.11 MPI-B Diagnostics**

Address	Item	Notes
0	Front openings	
1	Rear openings	
2	Floors	
3	Bottom floor	
4	Top floor	
5	Bottom landing	
6	Top landing	
7	Bottom position	
8	Top position	
9	Raw position	
10	Absolute position	
11	Relative position	
12	Delta Distance	
13	Offset distance	
14	Delta position errors	
15	Delta speed errors	
16	Processed speed feedback	

**Table 4.11 MPI-B Diagnostics**

Address	Item	Notes
17	Raw speed feedback	
18	Speed @ leveling over-speed fault	
19	Speed @ inspection over-speed fault	
20	Speed @ contract over-speed fault	
21	Runtime speed @ DETS	
22	Runtime speed @ DNTS1	
23	Runtime speed @ DNTS2	
24	Runtime speed @ DNTS3	
25	Runtime speed @ DNTS4	
26	Runtime speed @ DNTS5	
27	Runtime speed @ UETS	
28	Runtime speed @ UNTS1	
29	Runtime speed @ UNTS2	
30	Runtime speed @ UNTS3	
31	Runtime speed @ UNTS4	
32	Runtime speed @ UNTS5	
33	Speed @ DETS over-speed fault	
34	Speed @ DNTS1 over-speed fault	
35	Speed @ DNTS2 over-speed fault	
36	Speed @ DNTS3 over-speed fault	
37	Speed @ DNTS4 over-speed fault	
38	Speed @ DNTS5 over-speed fault	
39	Speed @ UETS over-speed fault	
40	Speed @ UNTS1 over-speed fault	
41	Speed @ UNTS2 over-speed fault	
42	Speed @ UNTS3 over-speed fault	
43	Speed @ UNTS4 over-speed fault	
44	Speed @ UNTS5 over-speed fault	
45	Runtime distance @ DETS	
46	Runtime distance @ DNTS1	
47	Runtime distance @ DNTS2	
48	Runtime distance @ DNTS3	
94	Runtime distance @ DNTS4	
50	Runtime distance @ DNTS5	
51	Runtime distance @ UETS	
52	Runtime distance @ UNTS1	
53	Runtime distance @ UNTS2	
54	Runtime distance @ UNTS3	
55	Runtime distance @ UNTS4	
56	Runtime distance @ UNTS5	
57	Distance @ DETS position fault	
58	Distance @ DNTS1 position fault	
59	Distance @ DNTS2 position fault	

**Table 4.11 MPI-B Diagnostics**

Address	Item	Notes
60	Distance @ DNTS3 position fault	
61	Distance @ DNTS4 position fault	
62	Distance @ DNTS5 position fault	
63	Distance @ UETS position fault	
64	Distance @ UNTS1 position fault	
65	Distance @ UNTS2 position fault	
66	Distance @ UNTS3 position fault	
67	Distance @ UNTS4 position fault	
68	Distance @ UNTS5 position fault	
69	DETS type	
70	DTS1 type	
71	DNTS2 type	
72	DNTS3 type	
73	DNTS4 type	
74	DNTS5 type	
75	UETS type	
76	UNTS1 type	
77	UNTS2 type	
78	UNTS3 type	
79	UNTS4 type	
80	UNTS5 type	
81	Successful runs	
82	Fault runs	
83	Floor zone	
84	Position bypass count	
85	Position pass count	
86	System position count	
87	Absolute position count	
88	Position lower sequence	
89	Position upper sequence	
90	Position lower value	
91	Position upper value	
92	Landing code	
93	At landing	
95	Near floor	
100	Port A inputs: (n/a)	

**Table 4.11 MPI-B Diagnostics**

Address	Item	Notes
101	Port B inputs: 01 = (n/a) 02 = (n/a) 03 = (n/a) 04 = (n/a) 05 = UETS 06 = DETS 07 = (n/a) 08 = (n/a) 09 = EGOK 10 = RGR1 11 = RGR2 12 = RGOK 13 = (n/a) 14 = EB RST 15 = EBPS 16 = (n/a)	
102	Port C inputs: (n/a)	
103	Port D inputs: (n/a)	
104	Port E inputs: 01 = SW1-1 02 = SW1-2 03 = SW1-3 04 = SW1-4 05 = (n/a) 06 = (n/a) 07 = (n/a) 08 = (n/a) 09 = (n/a) 10 = (n/a) 11 = (n/a) 12 = (n/a) 13 = (n/a) 14 = (n/a) 15 = (n/a) 16 = (n/a)	
105	Port F inputs: (n/a)	
106	Port G inputs: (n/a)	

**Table 4.11 MPI-B Diagnostics**

Address	Item	Notes
110	Port A outputs: 01 = (n/a) 02 = (n/a) 03 = DIA2B 04 = DIA1B 05 = DIA7B 06 = DIA7B 07 = (n/a) 08 = (n/a) 09 = (n/a) 10 = DIA6B 11 = DIA5B 12 = (n/a) 13 = (n/a) 14 = (n/a) 15 = DIA8B 16 = DIA8B	
111	Port B outputs: (n/a)	
112	Port C outputs: 01 = (n/a) 02 = (n/a) 03 = (n/a) 04 = (n/a) 05 = (n/a) 06 = (n/a) 07 = (n/a) 08 = (n/a) 09 = (n/a) 10 = (n/a) 11 = (n/a) 12 = (n/a) 13 = (n/a) 14 = (n/a) 15 = (n/a) 16 = SPB ON LED	
113	Port D outputs: 01 = (n/a) 02 = (n/a) 03 = PME 04 = BRE 05 = DRE 06 = EB2 07 = EB3 08 = (n/a) 09 = (n/a) 10 = (n/a) 11 = (n/a) 12 = (n/a) 13 = (n/a) 14 = (n/a) 15 = (n/a) 16 = (n/a)	
114	Port E outputs: (n/a)	
115	Port F outputs: (n/a)	

**Table 4.11 MPI-B Diagnostics**

Address	Item	Notes
116	Port G outputs: 01 = (n/a) 02 = (n/a) 03 = DIA4B 04 = DIA3B 05 = (n/a) 06 = (n/a) 07 = (n/a) 08 = (n/a) 09 = (n/a) 10 = (n/a) 11 = (n/a) 12 = (n/a) 13 = (n/a) 14 = (n/a) 15 = (n/a) 16 = (n/a)	
200	Faults (01 - 16): 01 = Maximum position offset fault 02 = Minimum position offset fault 03 = Landing system fault (emergency brake dropped) 04 = Landing system communication loss fault 05 = Unintended motion 06 = SPC is offline 07 = SPA is offline 08 = (n/a) 09 = Inspection over-speed 10 = Contract over-speed 11 = Leveling over-speed 12 = EEPROM CRC error 13 = EEPROM device error 14 = ETS shutdown 15 = UETS over-speed 16 = UETS position error	

**Table 4.11 MPI-B Diagnostics**

Address	Item	Notes
201	Faults (17 - 32): 01 = DETS over-speed 02 = DETS position error 03 = Emergency brake cycle test fault 04 = PMDD contactor pick monitor fault 05 = PMDD contactor drop monitor fault 06 = 2L bus monitor fault 07 = RGOK fault (emergency brake dropped) 08 = Actual and requested direction mismatch 09 = Excessive faults shutdown 10 = 2MV bus monitor fault 11 = EBPS monitor fault 12 = UNTS-L over-speed 13 = UNTS-H over-speed 14 = UNTS position error 15 = DNTS-L over-speed 16 = DNTS-H over-speed	
202	Faults (33 - 48): 01 = DNTS position error 02 = RGOK monitor fault 03 = (n/a) 04 = (n/a) 05 = (n/a) 06 = (n/a) 07 = (n/a) 08 = (n/a) 09 = (n/a) 10 = (n/a) 11 = (n/a) 12 = (n/a) 13 = (n/a) 14 = (n/a) 15 = (n/a) 16 = (n/a)	
203	Faults (49 - 64): (n/a)	
300	16 = BRE (MPI-B) 15 = DRE (MPI-B) 14 = PME (MPI-B) 13 = DRE (MPI-C) 12 = BRE (MPI-C) 11 = PME (MPI-C) 10 = (n/a) 09 = (n/a) 08 = (n/a) 07 = (n/a) 06 = (n/a) 05 = (n/a) 04 = (n/a) 03 = Danger 02 = Fault 01 = Ready	

**Table 4.11 MPI-B Diagnostics**

Address	Item	Notes
301	16 = (n/a) 15 = (n/a) 14 = (n/a) 13 = Up slowdown 12 = Down slowdown 11 = Up direction limit 10 = Down direction limit 09 = Front level up 08 = Front door zone 07 = Front level down 06 = Rear level up 05 = Rear door zone 04 = Rear level down 03 = High speed 02 = Up 01 = Down	
302	16 = (n/a) 15 = (n/a) 14 = (n/a) 13 = (n/a) 12 = (n/a) 11 = (n/a) 10 = Up slowdown 09 = Down slowdown 08 = Near top 07 = Near bottom 06 = Up direction limit 05 = Down direction limit 04 = Front door zone 03 = Rear door zone 02 = Up 01 = Down	
303	16 = UETS status 15 = UTS1 status 14 = UNTS2 status 13 = UNTS3 status 12 = UNTS4 status 11 = UNTS5 status 10 = DETS status 09 = DNTS1 status 08 = DNTS2 status 07 = DNTS3 status 06 = DNTS4 status 05 = DNTS5 status 04 = Front door zone 03 = Rear door zone 02 = Up 01 = Down	
400	Down distance @ 100% of contract speed	
401	Down distance @ 90% of contract speed	
402	Down distance @ 80% of contract speed	
403	Down distance @ 70% of contract speed	



**Table 4.11 MPI-B Diagnostics**

Address	Item	Notes
404	Down distance @ 60% of contract speed	
405	Down distance @ 50% of contract speed	
406	Down distance @ 40% of contract speed	
407	Down distance @ 30% of contract speed	
408	Down distance @ 20% of contract speed	
409	Down distance @ 10% of contract speed	
410	Up distance @ 100% of contract speed	
411	Up distance @ 90% of contract speed	
412	Up distance @ 80% of contract speed	
413	Up distance @ 70% of contract speed	
414	Up distance @ 60% of contract speed	
415	Up distance @ 50% of contract speed	
416	Up distance @ 40% of contract speed	
417	Up distance @ 30% of contract speed	
418	Up distance @ 20% of contract speed	
419	Up distance @ 10% of contract speed	
420	Upper Elgo sensor position in m/in	Example: 1.019M. Processed raw position for MPI-B and MPI-C. Median for MPI-A.
421	Lower Elgo sensor position in m/in	Example: 0.859M. Processed raw position for MPI-A and MPI-C. Median for MPI-B.
422	Median Elgo sensor position in m/in	Upper sensor position for MPI-A, lower for MPI-B
423	Elgo sensor offset in m/in	Distance between upper and lower sensors. About +160mm for short Elgo sensor head and +240mm for long sensor head.
900	Software ID	
901	Software Revision	
902	Firmware Revision	
903	Hardware Revision	

## MPI-C Diagnostics

The following diagnostic information can be viewed for Main Processor on the TC-MPI Motion Processor Interface board.

**Table 4.12 MPI-C Diagnostics**

Address	Item	Notes
0	Front openings	
1	Rear openings	
2	Floors	
3	Bottom floor	
4	Top floor	
5	Bottom landing	
6	Top landing	
7	Bottom position	
8	Top position	
9	Raw position	
10	Absolute position	
11	Relative position	
12	Upper synchronization position errors	
13	Lower synchronization position errors	
14	Delta position errors	
15	Delta Speed errors	
16	Processed speed feedback	
17	Raw speed feedback	
18	Speed command	
19	Speed @ inspection over-speed fault	
20	Speed @ contract over-speed fault	
21	Down distance @ 100% of contract speed	
22	Down distance @ 90% of contract speed	
23	Down distance @ 80% of contract speed	
24	Down distance @ 70% of contract speed	
25	Down distance @ 60% of contract speed	
26	Down distance @ 50% of contract speed	
27	Down distance @ 40% of contract speed	
28	Down distance @ 30% of contract speed	
29	Down distance @ 20% of contract speed	
30	Down distance @ 10% of contract speed	
31	Up distance @ 100% of contract speed	
32	Up distance @ 90% of contract speed	
33	Up distance @ 80% of contract speed	
34	Up distance @ 70% of contract speed	
35	Up distance @ 60% of contract speed	
36	Up distance @ 50% of contract speed	
37	Up distance @ 40% of contract speed	
38	Up distance @ 30% of contract speed	
39	Up distance @ 20% of contract speed	

**Table 4.12 MPI-C Diagnostics**

Address	Item	Notes
40	Up distance @ 10% of contract speed	
41	Actual landing	
42	Target landing	
43	Logical landing	
81	Successful runs	
82	Fault runs	
83	Control RPM	
84	Position Bypass	
85	Position Pass	
86	Drive: 17-32 = Control command 01-16 = Control input	
90	Lower position	
91	Upper position	
92	Lower speed	
93	Upper speed	
94	Location: 25-32 = Target floor 17-24 = Start floor 09-16 = Below floor 01-08 = Above floor	
95	Near floor	
100	Port A signal: (n/a)	
101	Port B signal: 01 = (n/a) 02 = (n/a) 03 = QEFLT 04 = ZCHAN 05 = ACHAN 06 = BCHAN 07 = (n/a) 08 = (n/a) 09 = DFLT 10 = DRDY 11 = DRO 12 = CWI 13 = EQR 14 = SSI 15 = BUS 2MV 16 = BUS 2L	
102	Port C signal: (n/a)	
103	Port D signal: (n/a)	

**Table 4.12 MPI-C Diagnostics**

Address	Item	Notes
104	Port E signal: 01 = MDRE 02 = (n/a) 03 = (n/a) 04 = (n/a) 05 = (n/a) 06 = (n/a) 07 = (n/a) 08 = (n/a) 09 = (n/a) 10 = (n/a) 11 = (n/a) 12 = (n/a) 13 = (n/a) 14 = (n/a) 15 = (n/a) 16 = (n/a)	
105	Port F signal: (n/a)	
106	Port G signal: (n/a)	
110	Port A input: (n/a)	
111	Port B input: 01 = (n/a) 02 = (n/a) 03 = QEFLT 04 = ZCHAN 05 = ACHAN 06 = BCHAN 07 = (n/a) 08 = (n/a) 09 = DFLT 10 = DRDY 11 = DRO 12 = CWI 13 = EQR 14 = SSI 15 = BUS 2MV 16 = BUS 2L	
112	Port C input: (n/a)	
113	Port D input: (n/a)	

Table 4.12 MPI-C Diagnostics

Address	Item	Notes
114	Port E input: 01 = MDRE 02 = (n/a) 03 = (n/a) 04 = (n/a) 05 = (n/a) 06 = (n/a) 07 = (n/a) 08 = (n/a) 09 = (n/a) 10 = (n/a) 11 = (n/a) 12 = (n/a) 13 = (n/a) 14 = (n/a) 15 = (n/a) 16 = (n/a)	
115	Port F input: (n/a)	
116	Port G input: (n/a)	
120	Port A output: 01 = (n/a) 02 = (n/a) 03 = DIA2C 04 = DIA1C 05 = (n/a) 06 = (n/a) 07 = (n/a) 08 = (n/a) 09 = (n/a) 10 = PWR LED 11 = EQ LED 12 = (n/a) 13 = (n/a) 14 = (n/a) 15 = (n/a) 16 = (n/a)	
121	Port B output: 01 = DIA5C 02 = DIA6C 03 = (n/a) 04 = (n/a) 05 = (n/a) 06 = (n/a) 07 = DIA4C 08 = DIA3C 09 = (n/a) 10 = (n/a) 11 = (n/a) 12 = (n/a) 13 = (n/a) 14 = (n/a) 15 = (n/a) 16 = (n/a)	
122	Port C output: (n/a)	

**Table 4.12 MPI-C Diagnostics**

Address	Item	Notes
123	Port D output: 01 = FBS 02 = EQIND 03 = PME 04 = BRE 05 = DRE 06 = BRC 07 = (n/a) 08 = (n/a) 09 = (n/a) 10 = (n/a) 11 = (n/a) 12 = (n/a) 13 = (n/a) 14 = (n/a) 15 = (n/a) 16 = (n/a)	
124	Port E output: (n/a)	
125	Port F output: (n/a)	
126	Port G output: 01 = (n/a) 02 = (n/a) 03 = DIA7C 04 = DIA8C 05 = (n/a) 06 = (n/a) 07 = (n/a) 08 = (n/a) 09 = (n/a) 10 = (n/a) 11 = (n/a) 12 = (n/a) 13 = (n/a) 14 = (n/a) 15 = (n/a) 16 = (n/a)	
127	Machine command	
128	Motor command	
129	Brake command	

Table 4.12 MPI-C Diagnostics

Address	Item	Notes
130	01 \                     02                       03                       04 \ Diagnostic switches                     05 /                     06                       07                       08 /                     09 = Encoder fault                     10 = Encoder channel Z                     11 = Encoder channel A                     12 = Encoder channel B                     13 = Drive fault                     14 = Drive ready                     15 = Drive on monitor                     16 = Counterweight signal	
131	01 = Earthquake reset                     02 = Seismic switch                     03 = Bus 2                     04 = Bus 2L                     05 = Bus 2S                     06 = Run                     07 = Reset                     08 = Test                     09 = Inspection                     10 = Battery                     11 = Generator                     12 = Earthquake                     13 = Conservation                     14 = Terminal                     15 = Ready                     16 = Fault	
132	01 = Safety string                     02 = Safety string monitor                     03 = Door locks                     04 = Door locks monitor                     05 = Motor contactor                     06 = Motor contactor monitor                     07 = Motor contactor proofing                     08 = Brake contactor                     09 = Brake contactor monitor                     10 = Brake contactor proofing                     11 = Front level up                     12 = Front door zone                     13 = Front level down                     14 = Rear level up                     15 = Rear door zone                     16 = Rear level down	

**Table 4.12 MPI-C Diagnostics**

Address	Item	Notes
133	01 = Near top 02 = Near bottom 03 = High speed 04 = Up direction limit 05 = Down direction limit 06 = Wind 07 = (n/a) 08 = (n/a) 09 = (n/a) 10 = (n/a) 11 = (n/a) 12 = (n/a) 13 = (n/a) 14 = (n/a) 15 = (n/a) 16 = (n/a)	
200	Faults (01-16): 01 = Motor contactor pick fault 02 = Motor contactor drop fault 03 = Brake contactor pick fault 04 = Brake contactor drop fault 05 = Motor contactor pick proofing fault 06 = Motor contactor drop proofing fault 07 = Brake contactor pick proofing fault 08 = Brake contactor drop proofing fault 09 = Drive not ready 10 = Drive fault 11 = Drive on fault 12 = Drive off fault 13 = Receive communication fault 14 = Transmit communication fault 15 = EEPROM CRC fault 16 = EEPROM device fault	
201	Faults (17 - 32): 01 = Drive position mode fault 02 = Inspection over-speed fault 03 = Contract over-speed fault 04 = Excessive faults shutdown 05 = Landing system A position deviation fault 06 = Landing system B position deviation fault 07 = (n/a) 08 = (n/a) 09 = (n/a) 10 = (n/a) 11 = (n/a) 12 = (n/a) 13 = (n/a) 14 = (n/a) 15 = (n/a) 16 = (n/a)	
202	Faults (33 - 48): (n/a)	
203	Faults (49 - 64): (n/a)	



Table 4.12 MPI-C Diagnostics

Address	Item	Notes
300	16 = Up 15 = Down 14 = High speed 13 = (n/a) 12 = (n/a) 11 = (n/a) 10 = (n/a) 09 = Normal run 08 = Correction run 07 = Inspection run 06 = Terminal 05 = Danger 04 = System Ready 03 = Ready 02 = System fault 01 = Fault	
301	16 = Up 15 = Down 14 = High speed 13 = Front level up 12 = Front door zone 11 = Front level down 10 = Rear level up 09 = Rear door zone 08 = Rear level down 07 = (n/a) 06 = Terminal 05 = Danger 04 = System ready 03 = Ready 02 = System fault 01 = Fault	
302	16 = Up 15 = Down 14 = High speed 13 = Motor contactor monitor 12 = Motor contactor proofing 11 = Motor contactor 10 = Drive active 09 = Drive on monitor 08 = Drive enable 07 = Drive on 06 = Brake contactor monitor 05 = Brake contactor proofing 04 = Brake contactor 03 = Brake enable 02 = Brake pick 01 = Brake on	
303	Machine: 25-32 = Brake State 17-24 = Motor State 09-16 = Machine State 01-08 = Machine Command	

**Table 4.12 MPI-C Diagnostics**

Address	Item	Notes
420	Upper Elgo sensor position in m/in	Example: 1.019M. Processed raw position for MPI-B and MPI-C. Median for MPI-A.
421	Lower Elgo sensor position in m/in	Example: 0.859M. Processed raw position for MPI-A and MPI-C. Median for MPI-B.
422	Elgo sensor offset in m/in	Distance between upper and lower sensors. About +160mm for short Elgo sensor head and +240mm for long sensor head.
423	Median sensor position in m/in	Upper sensor position for MPI-C.
424	Brake command signal	
425	Brake command voltage	
426	Brake command lift rate	
427	Brake command drop rate	
428	Brake pick voltage	
429	Brake hold voltage	
430	Brake relevel voltage	
431	Brake lift rate	
432	Brake drop rate	
900	Software ID	
901	Software Revision	
902	Firmware Revision	
903	Hardware Revision	

### System CAN Bus

The System CAN Bus/Data Viewing screen allows you to check the working status of the inputs and outputs of any MC-CPI Car Panel Interface board in the system.

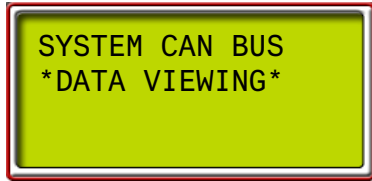

- Press S to enter the menu

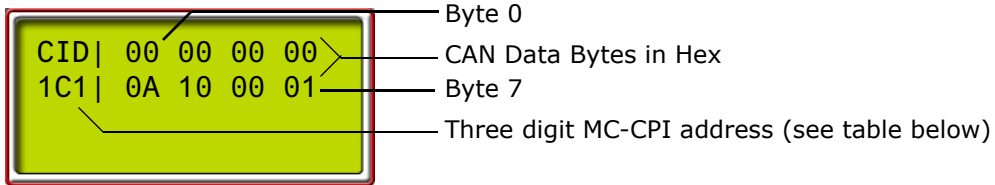

- Use the + or - buttons to increment/decrement address digit value
- Use the S button to move from digit to digit
  - As soon as a valid ID is on the screen, the CAN data from that ID will be visible as the hex data for each CAN byte changes.
  - With the desired ID selected, you can place a call from the affected control panel, or press a Door Open button, etc. and view the data transfer on the CAN bus.

**Table 4.13 MC-CPI Board Addresses**

ID	DATA
1C0	Output activity CPI board "0"
1C1	Input activity CPI board "0"
1C2	Output activity CPI board "1"
1C3	Input activity CPI board "1"
1C4	Output activity CPI board "2"
1C5	Input activity CPI board "2"
1C6	Output activity CPI board "3"
1C7	Input activity CPI board "3"
1C8	Output activity CPI board "4"
1C9	Input activity CPI board "4"
1CA	Output activity CPI board "5"
1CB	Input activity CPI board "5"
1CC	Output activity CPI board "6"
1CD	Input activity CPI board "6"
1CE	Output activity CPI board "7"
1CF	Input activity CPI board "7"

If CAN data is not appearing: Please refer to "Status and Error Messages" on page 5-2, entry "MPI A or B LANDING SYSTEM COMM LOSS" for relevant CAN connection car-to-controller troubleshooting information.

## Monitoring and Reporting Menu

If the controller is configured for monitoring or reporting connections through Ethernet, this menu is used to set up the port and to view communication statistics for diagnostic purposes.

- With “Monitoring and Reporting Menu” displayed, press S to enter the menu. The first screen provides a way to exit the menu without making changes. Press N to continue.

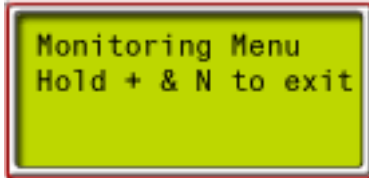

- The next screen provides the version number of the monitoring software in the controller. Press N to continue.

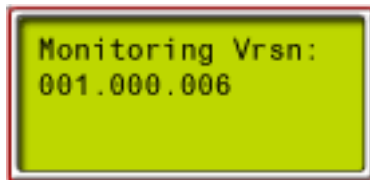

- The monitored type screen displays the controller type being monitored.

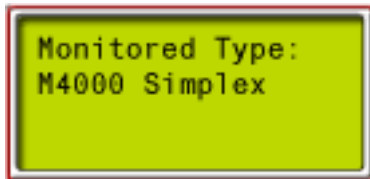

- Press N to move on. The IP address screen allows the IP address to be set:

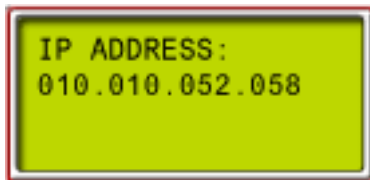

See note on following page.

- Press S to move from digit to digit.
- Press + or - to change value.
- Press N to exit.
- The subnet mask screen allows the mask address to be set:

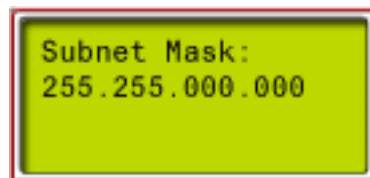

See note on following page.

- The gateway screen allows the gateway address to be set:

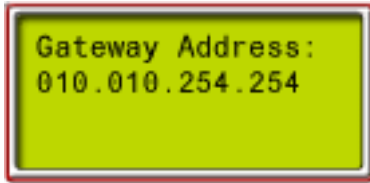

See note below.

**Note**

Any time you make a change to IP address, Subnet Mask, or Gateway Address, you must reset the HC-CHP board (Device) or the XPort. Refer to the information following.

**Diagnostics, Refresh, Reset**

The following screens provide diagnostic information, and allow Device and XPort refresh (poll for current data) or reset.

- The connections screen indicates which client connections are active. The XPort has the ability to connect to up to six iMonitors. This screen tells you how many connections are currently active.

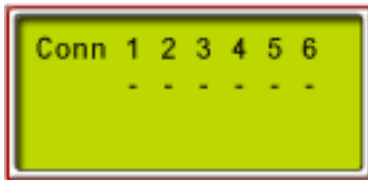

- The floors screen provides, left-to-right, the number of cars configured, if the car is a duplex dispatcher (D) or a local (L), and the number of floors configured.

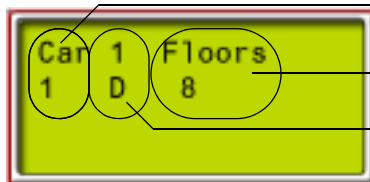

Number of cars configured

Car is dispatcher (D) or local (L)

Number of floors configured

- The XPort Comm Resets screen indicates the number of times the port has been reset since the last HC-CHP reset. If it exceeds three, you may have a network problem.

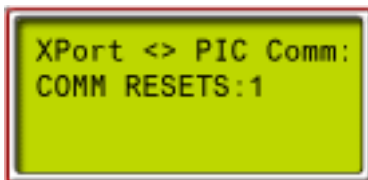

- The Receive/Transmit screen monitors the current number of receive and transmit messages in the XPort queue, the peak number of messages in that queue, and the maximum acceptable number of messages in each queue.

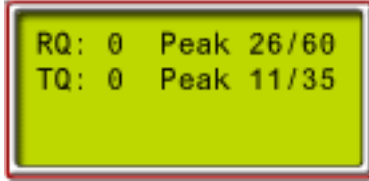

- The error diagnostic displays those data points being checked for change.

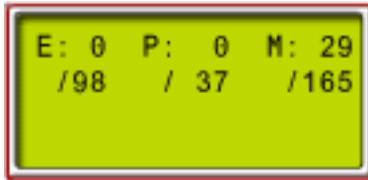

E = Events  
P = Parameters  
M = Monitors

- The Device Data screen displays the data byte in a particular register.

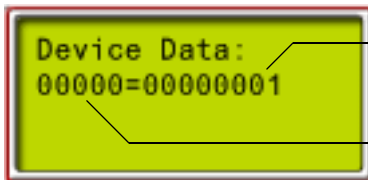

Data present

Register address

- The iReport screen shows the current status of iReport connections (None, Conn, Wait), and the last iReport Port and IP address that was connected.

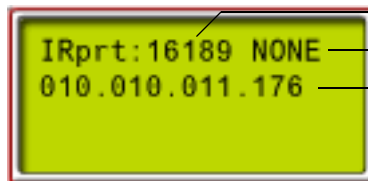

Port

Status: None, Conn, Wait

IP address

- The Reset XPort screen allows you to reset the XPort and related counters. Resetting is required after changing IP address, Subnet mask, or Gateway address.

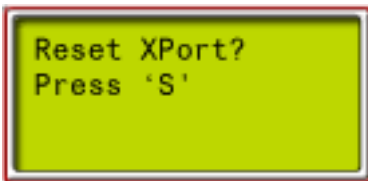

- Refresh Device allows you to trigger an immediate data gathering cycle to ensure you are seeing the latest processor information.

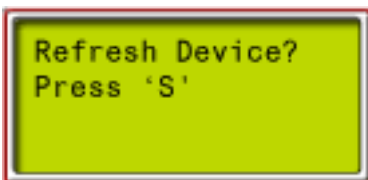

- Refresh XPort allows you to trigger an immediate data gathering cycle to ensure you are seeing the latest XPort information (IP address, Gateway address, Subnet Mask, and Type of controller).

A terminal window with a yellow background and black text. The text reads "Refresh XPort?" followed by "Press 'S'" on the next line. The window has a red border.

4

- The TFTP Status screen allows you to provide permission for an FTP updater to update the monitoring software on this controller.

A terminal window with a yellow background and black text. The text reads "TFTP Status: NO" followed by "Press 'S'" on the next line. The window has a red border.

- The Default XPort screen allows you to default the XPort to original factory programming.

A terminal window with a yellow background and black text. The text reads "Default XPort:" followed by "Press 'S'" on the next line. The window has a red border.

## Terminal Limit Utilities Menu

This menu allows you to learn hoistway switch positions. The car must be on Test mode.

A terminal window with a yellow background and black text. The text reads "- PERFORM UXTS -" on the first line and "- AND DXTS LEARN -" on the second line. The window has a red border.

Please refer to [Learning Floor Levels & Counterweight Position](#) on page 3-2.

## FCL Brake Unit Utilities Menu

This menu allows you to check CAN controlled brake module function, check commanded and actual pick voltage/amperage, default module TC-FCL parameters or calibrate a selected module TC-FCL for use on the Motion 4000 controller. Navigate to this menu using the N button, then select it using the S button to access sub-menus. Navigate between sub-menus using the N button. Review [Brake Module on page 2-12](#) for information about module addressing and functionality.

### FCL Diagnostic Menu

The FCL diagnostic menu allows data in particular module registries to be examined to diagnose board-level activity. If you are having a problem with a module and you suspect it is a problem with one of the module circuit boards, contact MCE Technical Support so that a technician can work with you to determine whether or not the module is faulty. Generically:

- Use S to move to the module number digit, then +/- to set.
- Use S to move to the register address fields, then +/- to set.
- The LCD will display data present in the selected module register.

### FCL Power Data Menu

The FCL power data menu allows you to see commanded and actual pick voltage and amperage for a selected brake module.

- Use +/- to select the module.
  - CMD: Commanded voltage
  - V: Actual applied voltage
  - A: Actual applied amperage.

### Default TC-FCL Parameters

This menu allows you to select a specific module, then default its values to factory settings.

- Place car on Machine Room Inspection.
- Use +/- to select the module. Press S to default.
- The module values will be defaulted to factory values.

### FCL Adjustment Menu

This menu is used to calibrate a selected module to Motion 4000 requirements.

- Place car on Machine Room Inspection.
- Use +/- to select the module. Press S to calibrate.
- The selected module will be calibrated and progress reported on the display.



## F6: Hoistway Learn Operations

The F6 menu provides a process to learn the floor levels and counterweight position for the building. The process is different depending on the type of landing/positioning system for the job.

### ELGO Encoded Magnetic Tape

1. Place the car on Inspection mode.
2. Verify the floors and openings through the F1 (Program Mode) menu if you have not already done so. ([F1: Program Mode on page 4-11.](#))
3. Plug the hand-held user interface into a CAN connection in the car panel or on the car-top. Otherwise, use the HC-MPU board keypad/LCD in the controller. (If the controller keypad is used, a technician must be stationed in the car to relay information to the technician in the machine room.)
4. Move the car to level at the first floor.
5. Select the F6 menu on the hand-held or HC-MPU board (F6 switch UP, all others down).

- **ELGO LEARN. PRESS NEXT TO LEARN OR SELECT TO FILL**

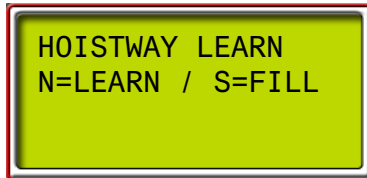

**Learn** Selecting LEARN starts a process in which you move the car up the hoistway a floor at a time, leveling and saving at each floor.

1. Press N. The display will prompt: Go to landing 1.
  2. Bring the car as close to level at landing 1 as is practical. Press S.
  3. The display will ask you to enter an offset to make up for any difference in level between car and floor: xxx.x In. Adj + - Next when done.
  4. Measure the offset (if any).
  5. If the car is above the floor, use the + (plus) button to enter the offset value. If the car is below the floor, use the - (minus) button to enter the offset value.
  6. Press N. The display will prompt you to move to the next landing. The process will repeat at each landing until all have been learned.
  7. When all floors have been learned, the display will prompt you to learn counterweight position.
- **MOVE CAR ADJACENT TO COUNTERWEIGHT, THEN PRESS NEXT.**
8. Move the car until car and counterweight are level with one another in the hoistway.
  9. Press N. The display will prompt you to store values:
- **HOISTWAY LEARNED. S=STORE.**
10. Press S. The display will prompt:

- **HOISTWAY STORED**

11. Exit F6 menu on the hand-held or place F6 switch down on the HC-MPU board.

**Fill** Selecting FILL allows you to enter a common height for all floors which will then be filled in by system software. The position of the counterweight is automatically set to one half the cumulative height of the floors.

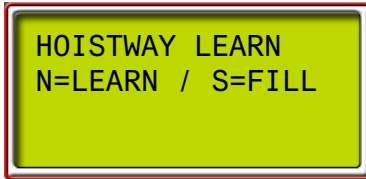

1. With the car level at floor one, Press S.
2. Use the “+”/”-” buttons to enter a common floor height in inches.

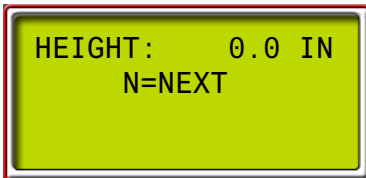

3. Press N. The display will prompt you to store values:

- **HOISTWAY LEARNED. S=STORE.**

4. Press S. The display will prompt:

- **HOISTWAY STORED**

5. Exit F6 menu on the hand-held or place F6 switch down on the HC-MPU board.

## LS-EDGE Steel Tape

1. Place the car on Inspection mode.
2. Verify the floors and openings through the F1 (Program Mode) menu if you have not already done so. (F1: [Program Mode on page 4-11.](#))
3. Select the F6 menu on the hand-held or HC-MPU board (F6 switch UP, all others down).

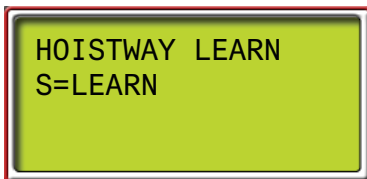

4. Press S to begin.
 

As you follow the instructions on the LCD, the car will first travel down to the bottom terminal at Correction speed and locate the center of the door zone magnet at that location. From the bottom terminal, the car will move up the hoistway finding each door zone and indicating the height in inches of each door zone magnet center. Upon reaching the top terminal, the LCD will display Learn Complete.

## Adjusting Floor Heights

Stored floor heights may be accessed through the F7 menu (first 64 parameters) and the height of each floor individually adjusted at any time. F7 parameter 67 allows you to adjust the counterweight height.

1. Enter the F7 menu (F7 up, all other switches down).
2. Press N to advance to the desired parameter.
3. Use “+” or “-” buttons to adjust the height of the floor (or counterweight).
4. Place F7 in the down position.

**4**

## F7: Parameters Adjust

Through the F7 menu, you learn the terminal switches, drive, and machine characteristics that influence speed and position computation. You start by uploading all parameters from the TC-MPI Motion Processor Interface board, then modify as necessary and save.

**Important** Once set at the factory, F7 parameters are protected by positioning a jumper on the HC-CTL board. Before you can access F7 parameters, you must set the jumper appropriately:



### Changing Parameters

1. Place the car on Inspection operation.
2. Set the F7 function switch to the up position.
3. The LCD will display:
  - Parameter adjust. Press Next to start. Press Select to resume.

**Next** Momentarily pressing Next (N) causes the MPU board to upload all parameters from the TC-MPI Motion Processor Interface board and display the first parameter.

**Select** Momentarily pressing Select (S) causes the MPU board display the parameter last viewed. This is intended to allow you to quickly access a parameter you are trying different adjustments with, save it, then run the car to see what the changes have done.

**Change** Use the + (plus) button to increment or the - (minus) button to decrement values. Once the value is set, momentarily press N (Next) to advance to the next parameter.

**Move Back** To move back to the previous parameter, press and hold N (Next), press - (minus), then release both buttons together.

### Saving Changes

1. After setting desired parameters and with the car still on Inspection: Press S to initiate a save operation.

The parameter viewed when the Save was initiated will be remembered. This allows you to quickly access a parameter, modify it, save it, run the car to see the effect, then return to edit further if needed. Scrolling to the end of the motion parameters will also initiate a save.

Once you have saved your changes, we recommend you re-position the jumper to protect F7 parameter settings.

## Controller Parameter/Drive Parameter Interaction

There are very important things to consider about the interaction between motion parameters set on the drive and the setting or collection of motion parameters on the controller.

- Drive parameters LF.20 Contract Speed and LF.11 Motor RPM determine the drive's Estimated Gear Ratio, LF.25. The drive will not drive the motor any faster than determined by the Gear Ratio set at LF.22. [Please refer to "Speed and Acceleration Control" on page 2-30.](#)

4

Note



**MOTION / DISTANCE DIAGNOSTIC** displays are provided through the F5 menu. They can be very helpful in seeing what is actually happening in the hoistway and using that information to fine tune settings or diagnose fault conditions. [Please refer to "MPI Diagnostic Menu" on page 4-64.](#)

## Using ID Numbers for Direct Parameter Access

All F7 parameters have a fixed ID number. When you are in the F7 menu, you can scroll to a particular ID by:

- Press and hold N (Next) to increment to the desired ID.
- Press and hold N, then press and hold - (minus) to decrement to the desired ID.

The table below lists the ID numbers and corresponding parameters. (There is a table that you can record your settings in on [page A-14](#) of the appendix.)

**Table 4.14 F7 Parameters**

#	Item	Min	Default	Max	Notes
1	Floor 1	-12.0 in	0.0 in	+12000.0 in	
2	Floor 2	-12.0 in	+120.0 in	+12000.0 in	
3	Floor 3	-12.0 in	+240.0 in	+12000.0 in	
4	Floor 4	-12.0 in	+360.0 in	+12000.0 in	
5	Floor 5	-12.0 in	+480.0 in	+12000.0 in	
6	Floor 6	-12.0 in	+600.0 in	+12000.0 in	
7	Floor 7	-12.0 in	+720.0 in	+12000.0 in	
8	Floor 8	-12.0 in	+840.0 in	+12000.0 in	
9	Floor 9	-12.0 in	+960.0 in	+12000.0 in	
10	Floor 10	-12.0 in	+1080.0 in	+12000.0 in	
11	Floor 11	-12.0 in	+1200.0 in	+12000.0 in	
12	Floor 12	-12.0 in	+1320.0 in	+12000.0 in	
13	Floor 13	-12.0 in	+1440.0 in	+12000.0 in	
14	Floor 14	-12.0 in	+1560.0 in	+12000.0 in	
15	Floor 15	-12.0 in	+1680.0 in	+12000.0 in	
16	Floor 16	-12.0 in	+1800.0 in	+12000.0 in	
17	Floor 17	-12.0 in	+1920.0 in	+12000.0 in	
18	Floor 18	-12.0 in	+2040.0 in	+12000.0 in	
19	Floor 19	-12.0 in	+2160.0 in	+12000.0 in	
20	Floor 20	-12.0 in	+2280.0 in	+12000.0 in	
21	Floor 21	-12.0 in	+2400.0 in	+12000.0 in	
22	Floor 22	-12.0 in	+2520.0 in	+12000.0 in	
23	Floor 23	-12.0 in	+2640.0 in	+12000.0 in	
24	Floor 24	-12.0 in	+2760.0 in	+12000.0 in	
25	Floor 25	-12.0 in	+2880.0 in	+12000.0 in	
26	Floor 26	-12.0 in	+3000.0 in	+12000.0 in	
27	Floor 27	-12.0 in	+3120.0 in	+12000.0 in	
28	Floor 28	-12.0 in	+3240.0 in	+12000.0 in	
29	Floor 29	-12.0 in	+3360.0 in	+12000.0 in	
30	Floor 30	-12.0 in	+3480.0 in	+12000.0 in	
31	Floor 31	-12.0 in	+3600.0 in	+12000.0 in	
32	Floor 32	-12.0 in	+3720.0 in	+12000.0 in	
33	Floor 33	-12.0 in	+3840.0 in	+12000.0 in	
34	Floor 34	-12.0 in	+3960.0 in	+12000.0 in	
35	Floor 35	-12.0 in	+4080.0 in	+12000.0 in	
36	Floor 36	-12.0 in	+4200.0 in	+12000.0 in	
37	Floor 37	-12.0 in	+4320.0 in	+12000.0 in	
38	Floor 38	-12.0 in	+4440.0 in	+12000.0 in	

Table 4.14 F7 Parameters

#	Item	Min	Default	Max	Notes
39	Floor 39	-12.0 in	+4560.0 in	+12000.0 in	
40	Floor 40	-12.0 in	+4680.0 in	+12000.0 in	
41	Floor 41	-12.0 in	+4800.0 in	+12000.0 in	
42	Floor 42	-12.0 in	+4920.0 in	+12000.0 in	
43	Floor 43	-12.0 in	+5040.0 in	+12000.0 in	
44	Floor 44	-12.0 in	+5160.0 in	+12000.0 in	
45	Floor 45	-12.0 in	+5280.0 in	+12000.0 in	
46	Floor 46	-12.0 in	+5400.0 in	+12000.0 in	
47	Floor 47	-12.0 in	+5520.0 in	+12000.0 in	
48	Floor 48	-12.0 in	+5640.0 in	+12000.0 in	
49	Floor 49	-12.0 in	+5760.0 in	+12000.0 in	
50	Floor 50	-12.0 in	+5880.0 in	+12000.0 in	
51	Floor 51	-12.0 in	+6000.0 in	+12000.0 in	
52	Floor 52	-12.0 in	+6120.0 in	+12000.0 in	
53	Floor 53	-12.0 in	+6240.0 in	+12000.0 in	
54	Floor 54	-12.0 in	+6360.0 in	+12000.0 in	
55	Floor 55	-12.0 in	+6480.0 in	+12000.0 in	
56	Floor 56	-12.0 in	+6600.0 in	+12000.0 in	
57	Floor 57	-12.0 in	+6600.0 in	+12000.0 in	
58	Floor 58	-12.0 in	+6720.0 in	+12000.0 in	
59	Floor 59	-12.0 in	+6840.0 in	+12000.0 in	
60	Floor 60	-12.0 in	+6960.0 in	+12000.0 in	
61	Floor 61	-12.0 in	+7080.0 in	+12000.0 in	
62	Floor 62	-12.0 in	+7200.0 in	+12000.0 in	
63	Floor 63	-12.0 in	+7320.0 in	+12000.0 in	
64	Floor 64	-12.0 in	+7440.0 in	+12000.0 in	
65	Bottom access distance	0.0 in	+120.0 in	+12000.0 in	
66	Top access distance	0.0 in	+120.0 in	+12000.0 in	
67	Counterweight position	0.0 in	+540.0 in	+12000.0 in	
68	Directional limit distance	0.0 in	+2.0 in	+1200.0 in	
69	U/DETS		VIRTUAL		UNUSED, VIRTUAL, PHYSICAL
70	U/DNT1		VIRTUAL		UNUSED, VIRTUAL, PHYSICAL
71	U/DNT2		UNUSED		UNUSED, VIRTUAL, PHYSICAL
72	U/DNT3		UNUSED		UNUSED, VIRTUAL, PHYSICAL
73	U/DNT4		UNUSED		UNUSED, VIRTUAL, PHYSICAL
74	U/DNT5		UNUSED		UNUSED, VIRTUAL, PHYSICAL
75	UETS speed	0 fpm	+332 fpm	+900 fpm	
76	UETS distance	-1200.0 in	+48.0 in	+1200.0 in	
77	UETS delta distance	-120.0 in	+6.0 in	+120.0 in	
78	UETS delta speed	0 fpm	20 fpm	+900 fpm	
79	UNTS1 speed	0 fpm	0 fpm	+900 fpm	
80	UNTS1 distance	-1200.0 in	+95.9 in	+1200.0 in	

**Table 4.14 F7 Parameters**

#	Item	Min	Default	Max	Notes
81	UNTS1 delta distance	-120.0 in	+6.0 in	+120.0 in	
82	UNTS1 delta low speed	0 fpm	0 fpm	+900 fpm	
83	UNTS1 delta high speed	0 fpm	0 fpm	+900 fpm	
84	UNTS2 speed	0 fpm	0 fpm	+900 fpm	
85	UNTS2 distance	-1200.0 in	0.0 in	+1200.0 in	
86	UNTS2 delta distance	-120.0 in	+6.0 in	+120.0 in	
87	UNTS2 delta low speed	0 fpm	0 fpm	+900 fpm	
88	UNTS2 delta high speed	0 fpm	0 fpm	+900 fpm	
89	UNTS3 speed	0 fpm	0 fpm	+900 fpm	
90	UNTS3 distance	-1200.0 in	0.0 in	+1200.0 in	
91	UNTS3 delta distance	-120.0 in	+6.0 in	+120.0 in	
92	UNTS3 delta low speed	0 fpm	0 fpm	+900 fpm	
93	UNTS3 delta high speed	0 fpm	0 fpm	+900 fpm	
94	UNTS4 speed	0 fpm	0 fpm	+900 fpm	
95	UNTS4 distance	-1200.0 in	0.0 in	+1200.0 in	
96	UNTS4 delta distance	-120.0 in	+6.0 in	+120.0 in	
97	UNTS4 delta low speed	0 fpm	0 fpm	+900 fpm	
98	UNTS4 delta high speed	0 fpm	0 fpm	+900 fpm	
99	UNTS5 speed	0 fpm	0 fpm	+900 fpm	
100	UNTS5 distance	-1200.0 in	0.0 in	+1200.0 in	
101	UNTS5 delta distance	-120.0 in	+6.0 in	+120.0 in	
102	UNTS5 delta low speed	0 fpm	0 fpm	+900 fpm	
103	UNTS5 delta high speed	0 fpm	0 fpm	+900 fpm	
104	DETS speed	0 fpm	+332 fpm	+900 fpm	
105	DETS distance	-1200.0 in	+48.0 in	+1200.0 in	
106	DETS delta distance	-120.0 in	+6.0 in	+120.0 in	
107	DETS delta speed	0 fpm	0 fpm	+900 fpm	
108	DNTS1 speed	0 fpm	0 fpm	+900 fpm	
109	DNTS1 distance	-1200.0 in	+95.9 in	+1200.0 in	
110	DNTS1 delta distance	-120.0 in	+6.0 in	+120.0 in	
111	DNTS1 delta low speed	0 fpm	0 fpm	+900 fpm	
112	DNTS1 delta high speed	0 fpm	0 fpm	+900 fpm	
113	DNTS2 speed	0 fpm	0 fpm	+900 fpm	
114	DNTS2 distance	-1200.0 in	0.0 in	+1200.0 in	
115	DNTS2 delta distance	-120.0 in	+6.0 in	+120.0 in	
116	DNTS2 delta low speed	0 fpm	0 fpm	+900 fpm	
117	DNTS2 delta high speed	0 fpm	0 fpm	+900 fpm	
118	DNTS3 speed	0 fpm	0 fpm	+900 fpm	
119	DNTS3 distance	-1200.0 in	0.0 in	+1200.0 in	



Table 4.14 F7 Parameters

#	Item	Min	Default	Max	Notes
120	DNTS3 delta distance	-120.0 in	+6.0 in	+120.0 in	
121	DNTS3 delta low speed	0 fpm	0 fpm	+900 fpm	
122	DNTS3 delta high speed	0 fpm	0 fpm	+900 fpm	
123	DNTS4 speed	0 fpm	0 fpm	+900 fpm	
124	DNTS4 distance	-1200.0 in	0.0 in	+1200.0 in	
125	DNTS4 delta distance	-120.0 in	+6.0 in	+120.0 in	
126	DNTS4 delta low speed	0 fpm	0 fpm	+900 fpm	
127	DNTS4 delta high speed	0 fpm	0 fpm	+900 fpm	
128	DNTS5 speed	0 fpm	0 fpm	+900 fpm	
129	DNTS5 distance	-1200.0 in	0.0 in	+1200.0 in	
130	DNTS5 delta distance	-120.0 in	+6.0 in	+120.0 in	
131	DNTS5 delta low speed	0 fpm	0 fpm	+900 fpm	
132	DNTS5 delta high speed	0 fpm	0 fpm	+900 fpm	
133	Brake pick delay	0 ms	0 ms	+10000 ms	
134	Speed pick delay	0 ms	+500 ms	+10000 ms	
135	Brake hold delay	0 ms	+2000 ms	+10000 ms	
136	Brake drop delay	0 ms	+500 ms	+2000 ms	
138	Drive disable delay	0 ms	+1250 ms	+2000 ms	
139	Speed hysteresis delay	0 ms	+1000 ms	+10000 ms	
140	Profile advance	0 ms	+100 ms	+1000 ms	
141	Profile scale	0%	100%	+1000%	
142	Standard slew slope	0.00 ft/s <sup>2</sup>	+0.49 ft/s <sup>2</sup>	+50.00 ft/s <sup>2</sup>	
143	Danger slew slope	0.00 ft/s <sup>2</sup>	+10.00 ft/s <sup>2</sup>	+50.00 ft/s <sup>2</sup>	
144	Slew filter	+0.1 Hz	+20.0 Hz	+20 Hz	
145	Contract over-speed	0 fpm	+375 fpm	+1000 fpm	
146	Inspection over-speed	0 fpm	+125 fpm	+148 fpm	
147	Leveling over-speed	0 fpm	+125 fpm	148 fpm	
148	Hoist-motor speed	+1.0 rpm	+1165.0 rpm	+9999.9 rpm	
149	Contract speed	+25 fpm	+350 fpm	+800 fpm	
150	High speed	+25 fpm	+350 fpm	+800 fpm	
151	Intermediate speed	+25 fpm	+300 fpm	+800 fpm	SPI1 terminal (TC-MPI board)
152	Earthquake speed	+25 fpm	+150 fpm	+150 fpm	
153	Auxiliary speed	+25 fpm	+250 fpm	+800 fpm	SPI2 terminal (TC-MPI board)
154	Backup power speed	+9 fpm	+200 fpm	+800 fpm	
155	Inspection speed (normal)	0 fpm	+50 fpm	+148 fpm	
156	Inspection speed (reduced)	0 fpm	+50 fpm	+148 fpm	
157	Correction speed	0 fpm	+75 fpm	+250 fpm	
158	Leveling speed	0 fpm	+4 fpm	+25 fpm	

**Table 4.14 F7 Parameters**

#	Item	Min	Default	Max	Notes
159	Re-leveling speed	0 fpm	+6 fpm	+25 fpm	
160	Leveling distance	0.0 in	+0.9 in	+9.0 in	
161	Re-leveling distance	0.0 in	+0.9 in	+9.0 in	
162	Proximity distance	0.0 in	+18.0 in	+120.0 in	
163	Leveling dead zone distance	0.0 in	+0.5 in	+3.0 in	
165	Standard start jerk	+0.10 ft/s <sup>3</sup>	+4.00 ft/s <sup>3</sup>	+15.00 ft/s <sup>3</sup>	
166	Standard roll jerk	+0.10 ft/s <sup>3</sup>	+4.00 ft/s <sup>3</sup>	+15.00 ft/s <sup>3</sup>	
167	Standard stop jerk	+0.10 ft/s <sup>3</sup>	+2.00 ft/s <sup>3</sup>	+15.00 ft/s <sup>3</sup>	
168	Standard acceleration	0.00 ft/s <sup>2</sup>	+2.00 ft/s <sup>2</sup>	+10.0 ft/s <sup>2</sup>	
169	Standard deceleration	0.00 ft/s <sup>2</sup>	+2.00 ft/s <sup>2</sup>	+10.0 ft/s <sup>2</sup>	
170	Manual start jerk	+0.10 ft/s <sup>3</sup>	+1.00 ft/s <sup>3</sup>	+15.00 ft/s <sup>3</sup>	
171	Manual roll jerk	+0.10 ft/s <sup>3</sup>	+1.00 ft/s <sup>3</sup>	+15.00 ft/s <sup>3</sup>	
172	Manual stop jerk	+0.10 ft/s <sup>3</sup>	+1.00 ft/s <sup>3</sup>	+15.00 ft/s <sup>3</sup>	
173	Manual acceleration	0.00 ft/s <sup>2</sup>	+0.50 ft/s <sup>2</sup>	+10.0 ft/s <sup>2</sup>	
174	Manual deceleration	0.00 ft/s <sup>2</sup>	+0.50 ft/s <sup>2</sup>	+10.0 ft/s <sup>2</sup>	
175	Danger start jerk	+0.10 ft/s <sup>3</sup>	+25.00 ft/s <sup>3</sup>	+50.00 ft/s <sup>3</sup>	
176	Danger roll jerk	+0.10 ft/s <sup>3</sup>	+25.00 ft/s <sup>3</sup>	+50.00 ft/s <sup>3</sup>	
177	Danger stop jerk	+0.10 ft/s <sup>3</sup>	+4.00 ft/s <sup>3</sup>	+50.00 ft/s <sup>3</sup>	
178	Danger deceleration	0.00 ft/s <sup>2</sup>	6.00 ft/s <sup>2</sup>	+15.00 ft/s <sup>2</sup>	
179	Alternate start jerk	+0.10 ft/s <sup>3</sup>	+2.00 ft/s <sup>3</sup>	+15.00 ft/s <sup>3</sup>	
180	Alternate roll jerk	+0.10 ft/s <sup>3</sup>	+2.00 ft/s <sup>3</sup>	+15.00 ft/s <sup>3</sup>	
181	Alternate stop jerk	+0.10 ft/s <sup>3</sup>	+2.00 ft/s <sup>3</sup>	+15.00 ft/s <sup>3</sup>	
182	Alternate acceleration	0.00 ft/s <sup>2</sup>	+1.50 ft/s <sup>2</sup>	+10.0 ft/s <sup>2</sup>	
183	Alternate deceleration	0.00 ft/s <sup>2</sup>	+1.50 ft/s <sup>2</sup>	+10.0 ft/s <sup>2</sup>	
184	Drive type		KEB F5-GRD50		KEB F5-GRD49, KEB F5-GLS49, KEB F5-GRD50, KEB F5-GLS50, YASKAWA, MAG QUATTRO, MAG HPV, MAG DSD
185	Brake type		DISCRETE		DISCRETE, ONE MODULE, TWO MODULES
186	Emergency brake		ROPE GRIPPER		DISABLED, ROPE GRIPPER, SHEAVE BRK, MACHINE BRK
187	Reduced inspect speed		OFF		OFF, ETS, NTS1, NTS2, NTS3, NTS4, NTS5
188	Unintended Motion		LEVEL ZONE		LEVEL ZONE, DOOR ZONE
189	Following error	0%	+50%	+1000%	
190	Sheave Brake Idle Delay	30S	30S	3600S	
191	Landing System		Elgo 160		Elgo-160, Elgo-240, LS-EDGE

Table 4.14 F7 Parameters

#	Item	Min	Default	Max	Notes
192	Speed Drop Delay		800 ms		Magnetek drives only. Time in milliseconds during which the drive should continue to exert motor control after the car has achieved the floor and before the brake has dropped.
193	Profile Compensation		Fixed		Dynamic: Variable, controller determined compensation for drive lag based on entry in parameter 140, Profile Advance. Fixed: Fixed compensation for drive lag using the parameter 140, Profile Advance setting.
194	Normal Brake Pick Voltage	0V		300V	
195	Normal Brake Hold Voltage	0V		300V	
196	Normal Brake Relevel Voltage	0V		300V	
197	Normal Brake Lift Rate	0%		100%	
198	Normal Brake Drop Rate	0%		100%	
199	Emergency Brake Type				Module or Discrete
200	Emergency Brake Pick Voltage	0V		300V	
201	Emergency Brake Hold Voltage	0V		300V	
202	Directional Limit Type		VIRTUAL		VIRTUAL, PHYSICAL

## Parameters

**Floor Heights** Parameters 1 through 64 represent floor heights within the building. Floor heights are stored as absolute values referenced to the first floor, which is always initially displayed as 0.0 inches. You have already learned all floor heights in the building (F6), so they will be displayed as you progress. For all floors and openings, you should need only to view data and press Next to continue. They are here so that, should it be necessary later, you can adjust a floor height here without having to relearn all floors.

**Figure 4.3 Adjust Floor Height, LCD Layout**

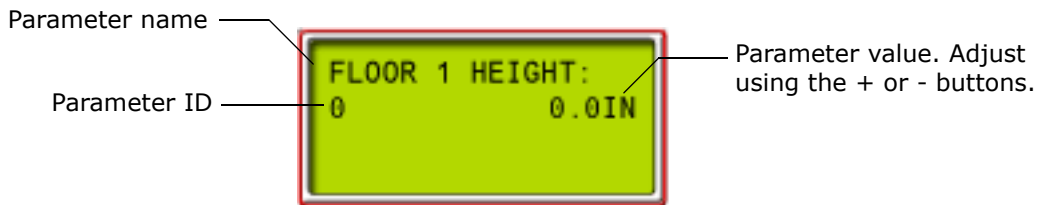

1. Press Next. The display will update to show the next opening/floor.
2. Continue using Next to move through the floors and openings.

**Bottom Access Distance, 65** This sets the distance above the bottom floor level at which the bottom access “switch” is placed. The value is entered in inches (1/10 inch increments). The Bottom Access Distance must be set such that it prevents the car from moving up beyond the point where the bottom of the toe guard is even with the hoistway entrance header.

**Top Access Distance, 66** This sets the distance below the top floor level at which the top access “switch” is placed. The value is entered in inches (1/10 inch increments). The Top Access Distance must be set such that it prevents the car from moving down beyond the point where the crosshead is even with the hoistway entrance sill.

### Note

**Hoistway Access:** Hoistway access allows the car to be moved to gain access to the car top or to the car bottom through hall and car doors. An enable switch in the car operating panel must be set to enable access, at which point switches at designated landings allow the car to be moved down to access the cartop or up to access the car bottom. Safety considerations will normally not allow the car to move with doors open, so Car Door Bypass and Hoistway Door Bypass switches on the HC-CTL board in the controller must also be set to Bypass positions before access is possible.

**Counterweight Position, 67** This is the position of the counterweight (in inches above the bottom floor) at which the car and counterweight are adjacent to one another in the hoistway. The value uploaded was learned in the floor level learn procedure. Check the value to see that it equates to approximately 1/2 the total travel of the car. Press Next to move to the next parameter.



**Counterweight Position:** Leave at the learned value. This parameter is provided here so that, should it be necessary, this position can be adjusted without having to re-learn floor heights.

**Directional Limit Distance, 68** This is the distance in inches at which the Directional Limit “switches” are placed beyond the terminal floor level positions. The value is entered in inches and is computed from the position of terminal floor levels. For example, a value of 2.0 would place the switches 2” past the level at floor position for each terminal.

If the car fails to stop level at the terminal, this “switch” will prevent the car from traveling further past the terminal landing. These “switches” must be positioned between the terminal floor level and the mechanical Final Limit Switches. If a car reaches the Final Limit Switch, the hoistway safety string will open and it will be necessary to jumper out the safeties to move the car off the limit.

**Terminal Switch Options, 69 - 74** On Motion 4000, hoistway switches, with the exception of the Final Limit Switches which are always physical switches, may be virtual (exist only in software) or physical. Depending upon job speed, not all switch positions may be used so there is also the option to set a switch position to “Unused.” The illustration below shows the switches that may be used on Motion 4000 (ETS, NTS-1, NTS-2, NTS-3, NTS-4, and NTS-5).

**Table 4.15 Hoistway Switch Requirements**

UETS/DETS and UNTSX/DNTSX switches requirement as per Rated speed (FPM)												
Car Speed (FPM)	UETS/DETS		UNTS1/DNTS1		UNTS2/DNTS2		UNTS3/DNTS3		UNTS4/DNTS4		UNTS5/DNTS5	
	Virtual switch	Learn speed	Virtual switch	Learn speed	Virtual switch	Learn speed	Virtual switch	Learn speed	Virtual switch	Learn speed	Virtual switch	Learn speed
Up to 399	√	80%	√	90%								
400-499	√	80%	√	70%	√	90%						
500-599	√	80%	√	60%	√	70%	√	90%				
600-699	√	80%	√	50%	√	60%	√	70%	√	90%		
>700	√	80%	√	40%	√	50%	√	60%	√	70%	√	90%

- Use the + or - buttons to select the kind of switch used on your job (Virtual/Physical/Unused). For jobs below 400 FPM, NTS-1 is used as the Slowdown Limit switch. As a result, ETS and NTS-1 should be set to “virtual” and all other switches should be set to “unused.”.

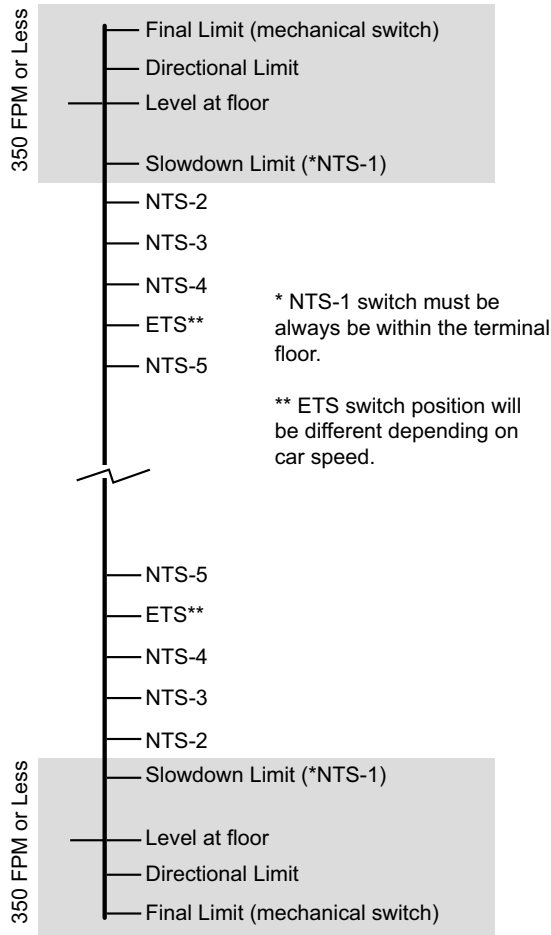

## Speed Related Parameters

Follow the learn operations described in Section 3 of this manual to set up hoistway switches. The A processor diagnostics table, [MPI-A Diagnostics on page 4-65](#), is very helpful in allowing you to view actual running conditions in the hoistway (speed at switches, etc.), and test your settings as you make adjustments.

**UETS Speed, 75** This is the speed, in feet per minute, which the car must be below when opening the Up Emergency Terminal Switch. This value, plus the value of the UETS Delta Speed settings, must not exceed 95% of Contract Speed.

### Note

**UETS Switch:** Depending upon the speed of the job, the Emergency Terminal Switch may be positioned differently. Refer to your job drawings package.

**UETS Distance, 76** This is the distance in inches from the top terminal floor level position at which the Up Emergency Terminal Switch is placed. This value is learned: [Please refer to “Measuring NTS and ETS Switch Locations” on page 3-15](#).

**UETS Delta Distance, 77** This is the distance in inches on either side of the Up Emergency Terminal Switch position inside which the car must detect the Up Emergency Terminal Switch. If the switch is not detected within this span, the car will perform an emergency stop. Generally set to 6.0 inches.

**UETS Delta Speed, 78** Delta Speed provides an “adder” to UETS speed. UETS speed and Delta speed together may not exceed 95% of contract speed. The switch speed is learned: [Please refer to “Terminal Learn” on page 3-17](#). Initially, calculate the Delta as  $95\% \text{ of Contract Speed} - \text{Learned Speed @ switch} = \text{Delta value}$ .

### Note

The UETS Speed setting plus the Delta Speed setting determines the speed which the car must be below in order to avoid an emergency stop. If you are tripping an ETS fault during car setup, you can choose to increase the ETS speed above contract speed or disable the ETS switches by setting them to Unused until you have sufficient control of the car.

**Reduced Stroke Buffers** Where reduced stroke buffers are used, the ETS inputs on the TC-MPI are used as ETSL (Emergency Terminal Slowdown) switches. ETSL position will be located at 90% of the reduced stroke buffer rated speed. ETSL Delta Speed will be 5% of the reduced stroke buffer rated speed. If ETSL is too far below the speed curve, you can adjust the Delta Speed closer to 10% of the reduced stroke buffer rated speed.

## Normal Terminal Switch Parameter Explanations

At contract speeds below 400 FPM, up and down normal terminal switches are not used as traditional limit switches. Instead, Normal Terminal Limit switches 2 - 5 are set to “unused” through controller F7 parameters and Normal Terminal Limit switches 1 Up and 1 Down are used as Terminal Slowdown Switches. (UNTS-2 and DNTS-2 do have a role when reduced stroke buffers are used.) The UNTS-1 and DNTS-1 switches also act as final position arbiters for the elevator positioning system. [Please refer to “Hoistway Switch Requirements” on page 2-52](#) for additional information.

At contract speeds above 400 FPM, Normal Terminal switches are used as required per contract speed. Each normal terminal switch has distance and speed parameters associated with it:

- **xNTSn Speed:** Learned value (percentage of normal run contract speed) at or below which the car must be traveling when the switch is encountered to avoid triggering an overspeed fault. If a fault is triggered, car reaction is determined by the Delta Low and Delta High speed settings.
- **xNTSn Delta Low Speed:** (3% of Learned Speed) If the car is traveling in excess of xNTSn Speed + xNTSn Delta Low Speed but not in excess of xNTSn Speed + xNTSn Delta High Speed, the controller will initiate a controlled slowdown to Correction Speed and continue toward the destination floor until reaching Proximity Distance from the landing. From this point, the controller will move the car at leveling speed and level into the landing.
- **xNTSn Delta High Speed:** (10% of Contract Speed) If the car is traveling in excess of xNTSn Speed + xNTSn Delta High Speed, the controller will initiate an emergency stop by cutting off power to the motor and dropping the machine brake. After coming to a complete stop, the car will travel to the destination floor at Correction Speed until reaching Proximity Distance from the landing. From this point, the controller will move the car at leveling speed and level into the landing.
- **xNTSn Distance:** Distance from the terminal at which the switch is located.
- **xNTSn Delta Distance:** Defines a distance on each side of the switch to establish a range within which the switch must be encountered to avoid triggering a switch position error. If a switch is not encountered within the range, the controller will initiate an emergency stop by cutting off power to the motor and dropping the machine brake. After coming to a complete stop, the car will travel to the terminal floor at reduced speed, open its doors to allow passenger exit, and remove itself from service until the fault is cleared.



### Note

Delta speeds are always added to the base speed at the switch. For example, if contract speed is 250 FPM, and learned switch Speed is 200 FPM, the Delta Low Speed is 6 FPM, and the Delta High Speed is 25 FPM, the low and high overspeed limits will be 206 FPM and 225 FPM respectively.



**UNTS1 Speed, 79** Learned value (percentage of Contract Speed) at which the car should be traveling when encountering this switch during a normal run to the terminal in order for normal stopping means to properly slow and stop the car. [Please refer to “Terminal Learn” on page 3-17.](#)

**UNTS1 Distance, 80** This is the distance in inches from the associated terminal floor level position at which this Normal Terminal Switch is placed. This value is learned: [Please refer to “Measuring NTS and ETS Switch Locations” on page 3-15.](#) NTS1 switches also provide a definitive position check for the PI system.

**UNTS1 Delta Distance, 81** This is the distance in inches on either side of the Up Normal Terminal Switch 1 position inside which the car must detect the Up Normal Terminal Switch. If the switch is not detected within this span, the car will drop high speed. Generally set to 6.0 inches.

**UNTS1 Delta Low Speed, 82** Nominal value is 3% of Learned Speed. [Please refer to “Normal Terminal Switch Parameter Explanations” on page 4-112.](#)

**UNTS1 Delta High Speed, 83** Nominal value is 10% of Contract Speed or 20 FPM, whichever is higher. [Please refer to “Normal Terminal Switch Parameter Explanations” on page 4-112.](#)

**UNTS2, 3, 4, 5** Speed, Distance, and Delta just as with UNTS-1, [page 4-113](#), but with distances and speeds per your Contract Speed. For any switch that has been set to “unused”, parameters can all be set to 0.0.

- **Below 400 FPM:** NTS2/3/4/5 switches normally set to unused.

These are starting values and will need to be adjusted according to actual car performance. Once you are able to run the car at contract speed, tune the settings to prevent unintentional tripping. [Please refer to “MPI-A Diagnostics” on page 4-65.](#)

**DETS Speed, 104** This is the speed, in feet per minute, which the car must be below when opening the Down Emergency Terminal Switch. This value, plus the value of the DETS Delta Speed settings, must not exceed 95% of Contract Speed.

**Note**

DETS Switch: Depending upon the speed of the job, the Emergency Terminal Switch may be positioned differently. Refer to your job drawings package.

**DETS Distance, 105** This is the distance in inches from the bottom terminal floor level position at which the Down Emergency Terminal Switch is placed. During a normal run, the car should be at 80% of Contract Speed at this point. This value is learned: [Please refer to “Measuring NTS and ETS Switch Locations” on page 3-15.](#)

**DETS Delta Distance, 106** This is the distance in inches on either side of the Down Emergency Terminal Switch position inside which the car must detect the Down Emergency Terminal Switch. If the switch is not detected within this span, the car will perform an emergency stop. Generally set to 6.0 inches.

**DETS Delta Speed, 107** Delta Speed provides an “adder” to DETS speed. DETS speed and Delta speed together may not exceed 95% of contract speed. The switch speed is learned: [Please refer to “Terminal Learn” on page 3-17.](#) Initially, calculate the Delta as 95% of Contract Speed - Learned Speed @ switch = Delta value.

**Note**

The DETS Speed setting plus the Delta Speed setting determines the speed which the car must be below in order to avoid an emergency stop. If you are tripping an ETS fault during car setup, you can choose to increase the ETS speed above contract speed or disable the ETS switches by setting them to Unused until you have sufficient control of the car.

**DNTS1 Speed, 108** Learned value (percentage of Contract Speed) at which the car should be traveling when encountering this switch during a normal run to the terminal in order for normal stopping means to properly slow and stop the car. [Please refer to “Terminal Learn” on page 3-17.](#)

**DNTS1 Distance** This is the distance in inches from the associated terminal floor level position at which this Normal Terminal Switch is placed. This value is learned: [Please refer to “Measuring NTS and ETS Switch Locations” on page 3-15.](#) NTS1 switches also provide a definitive position check for the PI system.

**DNTS1 Delta Distance, 110** This is the distance in inches on either side of the Down Normal Terminal Switch 1 position inside which the car must detect the Down Normal Terminal Switch. If the switch is not detected within this span, the car will drop high speed. Generally set to 6.0 inches.

**DNTS1 Delta Low Speed, 111** Nominal value is 3% of Learned Speed. [Please refer to “Normal Terminal Switch Parameter Explanations” on page 4-112.](#)

**DNTS1 Delta High Speed, 112** Nominal value is 10% of Contract Speed or 20 FPM, whichever is higher. [Please refer to “Normal Terminal Switch Parameter Explanations” on page 4-112.](#)

**DNTS2, 3, 4, 5** Speed, Distance, and Delta just as with DNTS-1 but with distances and speeds per your Contract Speed. For any switch that has been set to “unused”, parameters can all be set to 0.0.

- For reduced stroke buffers, refer to [UNTS2, 3, 4, 5 on page 4-113](#).

**Brake Pick Delay, 133** The time in milliseconds after the drive enable command is issued and acknowledged before the brake should pick. The default time of 0 (zero) milliseconds should be appropriate for virtually all scenarios.

**Speed Pick Delay, 134** The time in milliseconds after the brake is picked before the speed command is issued. This setting is used to prevent beginning movement under a slow-picking brake. The default of 500 milliseconds is a good starting point.

Figure 4.4 Effect of Speed Pick Delay on Start of Motion

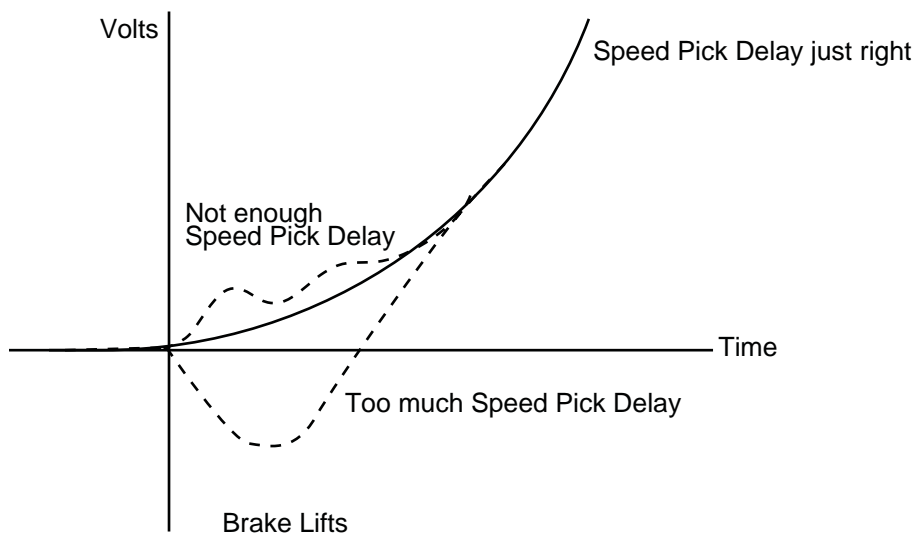

**Brake Hold Delay, 135** After take off, the brake is held fully picked until this timer expires, at which point it settles to hold position/voltage. Default time for a geared machine is 2000 ms. Default time for a gearless machine is 800 ms.

**Brake Drop Delay, 136** The delay, in milliseconds, that the brake should be delayed from dropping after the speed command is dropped. The goal is to avoid dropping the brake until the motor has just stopped moving. The default time of 250 milliseconds is a good starting point.

Figure 4.5 Effect of Brake Drop Delay on Stopping

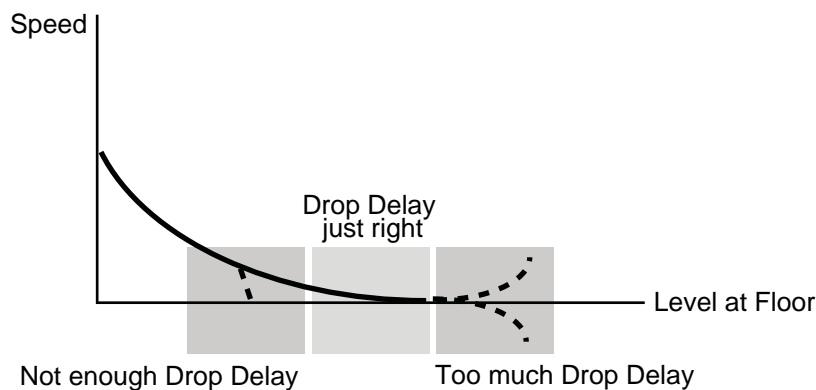

**Drive Disable Delay, 138** The time in milliseconds after stopping at a floor which the drive should maintain electrical control of the motor. May be used to compensate for a slow dropping brake. The default time of 1250 milliseconds should be appropriate for virtually all scenarios.

**Speed Hysteresis Delay, 139** Provides a delay between when the speed command is issued and when it begins to accelerate the load.

**Profile Advance, 140** Compensates for lag in the control loop. Values from 50 mS to 130 mS are common.

**Profile Scale, 141** Scales the curve to affect all associated speed settings. Typically used to slow all speeds associated with a curve without having to change individual speed settings. Useful for overspeed tests with the understanding that drive LF.22 will absolutely limit car speed.

**Standard Slew Slope, 142** Increases or decreases the steepness (rate) of change in acceleration for the standard curve.

**Danger Slew Slope, 143** Increases or decreases the steepness (rate) of change in deceleration for the danger curve.

**Slew Filter, 144** Smooths the slew slope of acceleration or deceleration, mitigating the sensation of jerkiness or uneven acceleration/deceleration. Too much can cause the curve to “stall.”

**Contract Overspeed, 145** The setting in feet per minute above contract speed at which a contract overspeed is detected and an emergency stop initiated. Generally set to about 8% above contract speed with variance due to the tracking accuracy of the drive/motor.

- $8\% \times \text{contract speed} + \text{contract speed} = \text{overspeed}$
- Example for 350 FPM:  $8\% \text{ of } 350 = 28 + 350 = 378 \text{ FPM}$

**Inspection Overspeed, 146** The setting in feet per minute above inspection speed at which an inspection overspeed is detected and an emergency stop initiated. Generally set to about 8% above inspection speed with variance due to the tracking accuracy of the drive/motor.

- $8\% \times \text{inspection speed} + \text{inspection speed} = \text{overspeed}$
- Example for 50 FPM:  $8\% \text{ of } 50 = 4 + 50 = 54 \text{ FPM}$

**Leveling Overspeed, 147** The setting in feet per minute above leveling speed at which a leveling overspeed is detected and an emergency stop initiated. Generally set to about 8% above leveling speed with variance due to the tracking accuracy of the drive/motor.

- $8\% \times \text{leveling speed} + \text{leveling speed} = \text{overspeed}$
- Example for 20 FPM:  $8\% \text{ of } 20 = 1.6 + 20 = 21.6 \text{ FPM}$

**Hoist Motor Speed, 148** Enter the motor RPM at which the car achieves contract speed (KEB LF.11). This information is available from the motor nameplate and is visible on KEB RU.7 when the car is running at contract speed. This rated motor RPM is the synchronous motor RPM minus slip RPM.

- Example for 6-pole geared machine: 1200 RPM (synchronous), 1165 RPM (rated).

**Contract Speed, 149** Enter the contract speed of the car in feet per minute.

**High Speed, 150** Enter the high speed limit for the Standard curve. Normally set to the same as Contract Speed. (Can be used to change car speed without changing profile.)

**Intermediate Speed, 151** Enter the reduced speed at which the car is to run when the SPI1 (Spare 1) input to the TC-MPI board is active. Intermediate speed uses the standard curve.

**Earthquake Speed, 152** If the elevator is allowed to run after a seismic event, this is the speed that will be used. Default is 150 FPM.

**Auxiliary Speed, 153** If the group control commands the car to run at economy speed, this is the speed that will be used. The group may command cars to run at normal contract speed during busy traffic or in response to a timer setting, or at reduced economy speed during light traffic or in response to a timer setting. Selected when the SPI2 (Spare 2) input to the TC-MPI board is active.

**Backup Power Speed, 154** If commercial power is lost and the elevator has backup power available, this is the speed that will be used.

**Inspection Speed (Normal), 155** Enter the normal Inspection Speed for the car.

**Inspection Speed (Reduced), 156** If the car reduces inspection speed upon encountering normal or emergency terminal speed switches, enter that reduced speed here.

**Correction Speed, 157** If the car should lose position, this is the speed at which it will proceed to a known point to re-establish position. Default is 75 FPM.

**Leveling Speed, 158** Leveling speed is the speed the car uses when initially leveling into the door zone. Default is 4 FPM.

**Re-Leveling Speed, 159** Should the car not level properly initially and require re-leveling, this is the speed that will be used. Default is 6 FPM.

**Leveling Distance, 160** This is the distance in inches (above and below) floor level at which the car should slow to leveling speed. Initially, set to 4.0 inches. After initial tuning, 2.0 inches is generally sufficient.

**Re-Leveling Distance, 161** If the car initially levels into the floor above or below this distance from accurate level, a re-leveling operation will proceed.

**Proximity Distance, 162** Determines the distance at which the speed is transitioned to leveling speed under abnormal conditions like an emergency slowdown.

**Leveling Dead Zone Distance, 163** This is the distance from floor level position at which the stop command is issued during initial leveling and the car “coasts” to a stop. Start with 0.7 inches.

**Standard Start Jerk, 165** Defines the transition from zero speed to full acceleration. As Start Jerk increases, the profile transitions more quickly from starting to maximum acceleration. Values typically range from 4.0 to 8.0 ft/s<sup>3</sup> (1.219 to 2.438 m/s<sup>3</sup>) with higher values resulting in a sharper start.

**Standard Roll Jerk, 166** Roll Jerk determines how quickly the profile transitions from maximum to zero acceleration and zero to maximum deceleration. As Roll Jerk increases, the profile transitions more quickly. Lower values provide greater comfort but are harder to fit into the shortest one-floor-runs. We recommend that you identify the shortest full height floor and use it when testing parameter values. Typical values range from a minimum of 4.0 ft.

**Standard Stop Jerk, 167** Defines the transition from deceleration to Leveling Speed. As Stop Jerk increases, the profile transitions more quickly from Deceleration to Leveling Speed.

**Standard Acceleration, 168** Determines the maximum acceleration for the profile. Determines the maximum current delivered by the AC Drive during acceleration. The maximum value is typically  $4.0 \text{ ft/s}^2$  ( $1.219 \text{ m/s}^2$ ) and the minimum is usually not less than  $2.5 \text{ ft/s}^2$  ( $0.762 \text{ m/s}^2$ ). Values higher than  $4.0 \text{ ft/s}^2$  ( $1.219 \text{ m/s}^2$ ) are possible but do not yield significant improvements in performance.

**Standard Deceleration, 169** Determines the maximum deceleration for this profile. The maximum value is typically  $4.0 \text{ ft/s}^2$  and the minimum is usually not less than  $2.0 \text{ ft/s}^2$  with more common values ranging from  $2.75 \text{ ft/s}^2$  to  $3.75 \text{ ft/s}^2$  ( $0.838$  to  $1.143 \text{ m/s}^2$ ). The value of Deceleration is usually slightly less than the value of Acceleration (by 0.25 to 0.5).

**Manual Start Jerk, 170** Defines the transition from zero speed to full acceleration. As Start Jerk increases, the profile transitions more quickly from starting to maximum acceleration. Values typically range from  $4.0$  to  $8.0 \text{ ft/s}^3$  ( $1.219$  to  $2.438 \text{ m/s}^3$ ) with higher values resulting in a sharper start.

**Manual Roll Jerk, 171** Roll Jerk determines how quickly the profile transitions from maximum to zero acceleration and zero to maximum deceleration. As Roll Jerk increases, the profile transitions more quickly. Typical values range from a minimum of  $4.0 \text{ ft}$ .

**Manual Stop Jerk, 172** Defines the transition from deceleration to stop. As Stop Jerk increases, the profile transitions more quickly.

**Manual Acceleration, 173** Determines the maximum acceleration for the profile. Determines the maximum current delivered by the AC Drive during acceleration. The maximum value is typically  $4.0 \text{ ft/s}^2$  ( $1.219 \text{ m/s}^2$ ) and the minimum is usually not less than  $2.5 \text{ ft/s}^2$  ( $0.762 \text{ m/s}^2$ ).

**Manual Deceleration, 174** Determines the maximum deceleration for this profile. The maximum value is typically  $4.0 \text{ ft/s}^2$  and the minimum is usually not less than  $2.0 \text{ ft/s}^2$  with more common values ranging from  $2.75 \text{ ft/s}^2$  to  $3.75 \text{ ft/s}^2$  ( $0.838$  to  $1.143 \text{ m/s}^2$ ). The value of Deceleration is usually slightly less than the value of Acceleration (by 0.25 to 0.5).

**Danger Start Jerk, 175** The Danger profile is used for emergency slowdown. If, after stopping, the car restarts while remaining on the Danger curve, this setting defines the transition from zero speed to full acceleration. As Start Jerk increases, the profile transitions more quickly from starting to maximum acceleration.

**Danger Roll Jerk, 176** Roll Jerk determines how quickly the profile transitions from maximum to zero acceleration and zero to maximum deceleration. As Roll Jerk increases, the profile transitions more quickly.

**Danger Stop Jerk, 177** Defines the transition from deceleration to stop. As Stop Jerk increases, the profile transitions more quickly.

**Danger Deceleration, 178** Determines the maximum deceleration for this profile.

**Alternate Start Jerk, 179** Defines the transition from zero speed to full acceleration. As Start Jerk increases, the profile transitions more quickly from starting to maximum acceleration. Values typically range from 4.0 to 8.0 ft/s<sup>3</sup> (1.219 to 2.438 m/s<sup>3</sup>) with higher values resulting in a sharper start.

**Alternate Roll Jerk, 180** Roll Jerk determines how quickly the profile transitions from maximum to zero acceleration and zero to maximum deceleration. As Roll Jerk increases, the profile transitions more quickly. Lower values provide greater comfort but are harder to fit into the shortest one-floor-runs. We recommend that you identify the shortest full height floor and use it when testing parameter values. Typical values range from a minimum of 4.0 ft.

**Alternate Stop Jerk, 181** Defines the transition from deceleration to Leveling Speed. As Stop Jerk increases, the profile transitions more quickly from Deceleration to Leveling Speed.

**Alternate Acceleration, 182** Determines the maximum acceleration for the profile. Determines the maximum current delivered by the AC Drive during acceleration. The maximum value is typically 4.0 ft/s<sup>2</sup> (1.219 m/s<sup>2</sup>) and the minimum is usually not less than 2.5 ft/s<sup>2</sup> (0.762 m/s<sup>2</sup>). Values higher than 4.0 ft/s<sup>2</sup> (1.219 m/s<sup>2</sup>) are possible but do not yield significant improvements in performance.

**Alternate Deceleration, 183** Determines the maximum deceleration for this profile. The maximum value is typically 4.0 ft/s<sup>2</sup> and the minimum is usually not less than 2.0 ft/s<sup>2</sup> with more common values ranging from 2.75 ft/s<sup>2</sup> to 3.75 ft/s<sup>2</sup> (0.838 to 1.143 m/s<sup>2</sup>). The value of Deceleration is usually slightly less than the value of Acceleration (by 0.25 to 0.5).

**Drive Type, 184** If using a TorqMax drive, check the TorqMax drive software version at drive parameter LF.80. If it is 1.71 or greater, select KEB F5-GRD50 (geared machines) or KEB F5-GLS50 (gearless machine). Otherwise, select KEB F5-GRD49 (geared) or KEB F5GLS49 (gearless).

**Brake Type, 185** Motion 4000 may be configured with one or two brake modules or a straight brake drop / brake pick brake (Discrete). Select the controller brake configuration.

**Emergency Brake, 186** This setting selects or disables the emergency brake option. Emergency Brake reset button requires constant pressure for 5 to 8 seconds to clear.

- Disabled: Set to Disabled if the job does not use an emergency brake or rope gripper.
- Rope Gripper: Select if job uses a rope gripper.
- Sheave Brake: Select if job uses a sheave brake.
- Machine Brake: Select if second machine brake used as the emergency brake.



**Reduced Inspection Speed, 187** This setting directs the controller to automatically reduce inspection speed to Inspection Speed Reduced (156) value when an Emergency Terminal or Normal Terminal Slowdown switch is encountered.

- Off: Inspection speed remains as set throughout the hoistway.
- ETS: Inspection speed is automatically reduced when the car is running on inspection and encounters an Emergency Terminal Switch.
- NTS-1/-2/-3/-4/-5: Inspection speed is automatically reduced when the car is running on inspection and encounters the selected Normal Terminal Slowdown switch.

**Unintended Motion, 188** Determines where unintended motion is detected.

- Level Zone: Detected when car moves out of the leveling zone.
- Door Zone: Detected when car moves out of the door zone.

**Following Error, 189** Following error sets the allowed margin of deviation from commanded speed as a percentage of that speed. An encoder error will be generated if the actual speed differs from the commanded speed by more than specified here. For example, if commanded speed is 250 FPM and Following Error is set to 5% (5% of 250 is 12.5), then the actual speed will be allowed to differ from 250 FPM by +/- 12.5 FPM without generating the error.

**Sheave Brake Idle Delay, 190** Appears if Sheave Brake is the selected emergency brake (186). When a car is idle, the sheave brake will drop after the time set here expires. Allows the brake to be exercised. Range is from 0 to 3600 seconds.

**Landing System, 191** Select the landing system used on this job.

- Elgo-160: Elgo system with sensors in the sensor head separated by 160mm.
- Elgo-240: Elgo system with sensors in the sensor head separated by 240mm.
- LS-EDGE: Magnet/Vane landing system.



Note

The sensor heads for the Elgo-160 and -240 systems are visibly different. The -160 sensor head is about 13.25 inches (336 mm) long while the -240 sensor head is about 19.00 inches (482 mm) long.

**Speed Drop Delay, 192** Parameter appears only when a Magnetek HPV600, HPV900, or QUATTRO drive is selected in parameter 184, Drive Type. The time in milliseconds during which the drive should continue to exert motor control after the direction command is removed (car has achieved the floor but brake has not yet dropped). Used for drives that do not independently provide a parameter to extend this period of control. Delay should be equal to or greater than the sum of brake drop delay and time required for the brake shoes to seat fully.

**Profile Compensation, 193** Selects the method used to implement Profile Advance, parameter 140 (used to advance application of the speed profile to compensate for internal control lag within the elevator drive). Helpful during runs in which the elevator does not achieve stable contract speed (i.e., short runs) and pattern transition command/drive reaction lag may cause a “bump” in the ride.

- **Fixed:** Compensates for drive control lag using the fixed value entered in parameter 140, Profile Advance through all stages of control. **Recommended for new installations.** Too much compensation can cause an abrupt transition between acceleration and deceleration at peak speed. Using fixed compensation will probably require a little experimentation to achieve good starts and a smooth ride but will provide better results once dialed in. Required when a Magnetek HPV600, HPV900, or QUATTRO drive is used.
- **Dynamic:** Compensates for drive control lag during the deceleration stage only using a variable percentage of the value entered in parameter 140, Profile Advance. **Recommended to provide backwards compatibility when upgrading Motion 4000 software in existing installations.** (Previous versions always used Dynamic compensation; fixed compensation was not an option.)

**Normal Brake Pick Voltage, 194** When a CAN controlled brake module is used, this setting determines pick voltage applied to the normal machine brake. See “[Calibration \(CAN Only\)](#)” on page 5-82.

**Normal Brake Hold Voltage, 195** When a CAN controlled brake module is used, this setting determines hold voltage applied to the normal machine brake. See “[Calibration \(CAN Only\)](#)” on page 5-82.

**Normal Brake Relevel Voltage, 196** When a CAN controlled brake module is used, this setting determines relevel voltage applied to the normal machine brake. See “[Calibration \(CAN Only\)](#)” on page 5-82.

**Normal Brake Lift Rate, 197** When a CAN controlled brake module is used, this setting determines the lift rate of the normal machine brake. 100% = fastest lift rate.

**Normal Brake Drop Rate, 198** When a CAN controlled brake module is used, this setting determines the drop rate of the normal machine brake. 100% = fastest drop rate.

**Emergency Brake Type, 199** This setting selects the method of control for the emergency brake. (CAN) Module or Discrete. Appears only if parameter 186 has been used to select an emergency brake type.

**Emergency Brake Pick Voltage, 200** Only if Module is selected in 199. Determines the pick voltage applied to the emergency machine brake. See “[Calibration \(CAN Only\)](#)” on page 5-82.

**Emergency Brake Hold Voltage, 201** Only if Module is selected in 199. Determines the hold voltage applied to the emergency machine brake. See “[Calibration \(CAN Only\)](#)” on page 5-82

**Directional Limit Type, 202** •Virtual/Physical

- Virtual: Directional limits remain software based and operate normally based upon the programmed distance above/below the top/bottom terminal landings.
- Physical: The U/DETS terminals on the TC-MPI board are used for connection to mechanical direction limit switches. For these jobs, customer connections for the directional limit switches will be made to appropriately labeled terminals on the panel mount terminal strip in the bottom of the controller cabinet.

4

**F7 Settings Record**

Use the table in the Appendix to record F7 menu settings. If the TC-MPI board is replaced in the future, this will provide you a quick way to re-enter proper settings. If you place a support call to MCE, this information will speed problem solving. [F7 Settings Record on page A-14.](#)

## F8: Software Revision

Displays current software level for each of the controllers processors.

- PTHC D  
VER # T08.01-0042



### Note

The “boot loader” IC polls each processor as the controller is powering up, ensuring that each has the right software. The software version for the boot loader itself is displayed in a scrolling message as the controller is powering up.

## Status Displays

To access Status Displays:

- Place function switch F8 in the up position (all others down).
- Press N to cycle through available status displays.

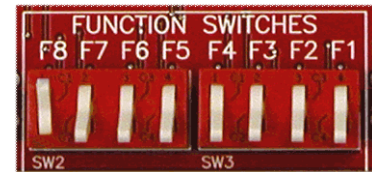

The following status displays are available:

- Software Version - Main processor software version number.
- Eligibility Map - Door access for each floor (F = front, R = rear, B = both). Read left to right:
  - Floors 1 through 16 in the top row
  - Floors 17 through 32 in the bottom row.

Please refer to “[CAR SERVES FRNT/FLR 1? \(simplex\)/THIS CAR SERVES FRNT/FLR 1? \(duplex\)](#)” on page 4-14 for programming instructions.

- Current Load - The current load in the car as a percentage of full load (analog load weigher required).

## F1 & F8: Board Software Versions

When both F1 and F8 switches are up, board software version numbers are visible. This can be helpful when troubleshooting with an MCE technician.

- Press N button for versions:
  - MPUA: MPU board software
  - CTLA: Control board A processor software
  - CTLB: Control board B processor software
  - CTLC: Control board C processor software
  - MPJA: Motion Processor board A processor software
  - MPJB: Motion Processor board B processor software
  - MPJC: Motion Processor board C processor software
  - UIO(0 - n): UIO board software
  - CHP: CHP board software

4





**Motion Control Engineering®**

A Kinetek Company®

*Troubleshooting*

## In This Section

This section contains troubleshooting information to help you correct problems. If you are reading this on a computer, you can click on blue text to jump to more information about the topic.

- Status and Error Messages: Table includes a description and troubleshooting tips for each message. [Please refer to “Status and Error Messages” on page 5-2.](#)
- Status Indicators: HC-MPU status LEDs indicate the state of the safety circuit, door locks, and mode of operation. [Please refer to “HC-MPU Main Processor Board” on page 5-50.](#)
- Diagnostic and External Memory Modes: Useful tools to isolate and diagnose problems. [Please refer to “Diagnostic Mode” on page 4-6](#) and to F5 diagnostic information [4-61.](#)
- PC Board Quick References: Circuit board information and photographs. [Please refer to “PC Board Quick References” on page 5-38.](#)
- Position and Speed Information: [Please refer to “MPI Diagnostic Menu” on page 4-64.](#)
- Brake Module Information: If the job uses the mBrake module for machine or emergency brake control, [see “Motion Brake Module” on page 5-76.](#)
- Wiring Prints: MCE job prints are technical drawings specifically generated for each installation. Use these drawings while tracing problems.

## Status and Error Messages

In Diagnostic Mode, the top line of the LCD displays elevator status. The message scrolls if it is too long to be displayed all at once. There are status messages for operating modes (e.g., FIRE SERVICE PHASE 1 - MAIN) and for error conditions (e.g., SAFETY CIRCUIT IS OPEN).

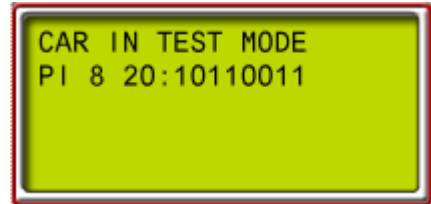

The following table contains some terms that are unique to MCE or to electronics manufacturing:

- 2 or 2xx Bus: These are 120VAC buses originating in the controller.
- IDC: Insulated Displacement Connectors. These are connectors that allow an insulated wire to be pressed into place where narrow “jaws” cut the insulation to provide positive connection. When an instruction says to “check IDC,” it means to check signal presence at that connector/number, the integrity of the wire, the source connection, and the source signal.
- NYCHA: New York City Housing Authority.
- Data Trap: An electronic “capture” of the present status, off or on (0 or 1) of eight signals. Used when troubleshooting to see that signals are in the expected state during a particular point of controller operation.
- Jumper: A board-mounted connector with exposed, vertical pins that can be shorted together using a small “jumper” designed to slide on to two pins.

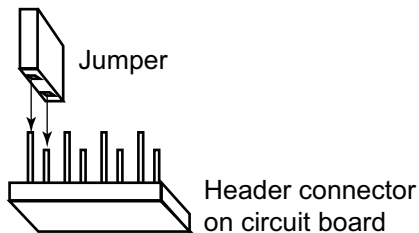

- PMT: Panel Mount Terminal. Gray screw-terminals arranged on a length of DIN rail. PMTs provide a convenient point of connection for field wiring.





When troubleshooting inputs, use built-in diagnostics to view memory registers so that you can see the actual state of the input. Please refer to “Troubleshooting Example” on page 4-8.

Table 5.1 Status and Error Messages

Scrolling Message - Special Event Message
<b>2 BUS IS LOW</b>
<b>Description:</b> 2 bus (120VAC) monitoring input is low. <b>Troubleshooting:</b> 1. Check fuse F2 on the HC-CTL board. 2. Check IDC connector J3, X4 on the HC-CTL board.
<b>2FS BUS IS LOW</b>
<b>Description:</b> 2FS bus (120VAC) monitoring input is low. <b>Troubleshooting:</b> 1. Check fuse F2FS on the HC-CTL board. 2. Check IDC connector J3, F2FS on the HC-CTL board.
<b>2HA BUS IS LOW</b>
<b>Description:</b> 2HA (120VAC) bus monitoring input is low. <b>Troubleshooting:</b> 1. Check fuse F2HA on the HC-CTL board. 2. Check IDC connector J3, X4 on the HC-CTL board.
<b>2MV BUS IS LOW</b>
<b>Description:</b> 2MV (120VAC) bus monitoring input is low. <b>Troubleshooting:</b> 1. Check fuse F2MV on the HC-CTL board. 2. Check IDC connector J3, 2MV on the HC-CTL board.
<b>2S INPUT FAILURE</b>
<b>Description:</b> The 2 bus for safety circuits (2S input on the HC-CTL board) is in an incorrect state. If the SAFC input has 120VAC, 2S must also have 120VAC. <b>Troubleshooting:</b> 1. Check the wiring and devices connected to the SAFC input. 2. Check the HC-CTL board ICS relay.
<b>ABD INPUT FAILURE</b>
<b>Description:</b> The Bottom Down Access (ABD) switch is at 120VAC when the 2HA bus is low. <b>Troubleshooting:</b> 1. Check for incorrect wiring or short on the HC-CTL board ABD input and 2HA or 2 bus 2. Check the bottom access switch and associated wiring per the job prints.
<b>ABU INPUT FAILURE</b>
<b>Description:</b> The Hoistway Access Bottom Up (ABU) switch is at 120VAC when the 2HA bus is low. <b>Troubleshooting:</b> 1. Check for incorrect wiring or short on the HC-CTL board ABU input and 2HA or 2 bus. 2. Check the bottom access switch and associated wiring per the job prints.
<b>ACCESS ENABLED</b>
<b>Description:</b> The controller is on Inspection Access mode, activated by either 120VAC at the Access Enable Switch input (screw terminal INA on the HC-CTL board) or by placing the front or rear hoistway or car door bypass switches in the bypass position.

**Table 5.1 Status and Error Messages**

Scrolling Message - Special Event Message
<b>ATD INPUT FAILURE</b>
<p><b>Description:</b> The Top Down Access (ATD) switch is at 120VAC when the 2HA bus is low.</p> <p><b>Troubleshooting:</b></p> <ol style="list-style-type: none"> <li>1. Check for incorrect wiring or short on the HC-CTL board ATD input and 2HA or 2 bus.</li> <li>2. Check the top access switch and associated wiring per the job prints.</li> </ol>
<b>ATTENDANT SERVICE OPERATION</b>
<p><b>Description:</b> The car is on attendant operation. The attendant service input (ATS) is activated.</p> <p><b>Troubleshooting:</b> In Program Mode (F1), check to see if any spare inputs are programmed as ATS, then check to see if that input is activated.</p>
<b>ATU INPUT FAILURE</b>
<p><b>Description:</b> The Top Up Access (ATU) switch is at 120VAC when the 2HA bus is low.</p> <p><b>Troubleshooting:</b></p> <ol style="list-style-type: none"> <li>1. Check for incorrect wiring or short on the HC-CTL board ATU input and 2HA or 2 bus.</li> <li>2. Check the top access switch and associated wiring per the job prints.</li> </ol>
<b>BATTERY BACKUP POWER SYSTEM FAULT</b>
<p><b>Description:</b> The battery powered rescue system has reported a fault.</p> <p><b>Troubleshooting:</b></p> <ol style="list-style-type: none"> <li>1. Check the display or fault indicators on the battery backup system.</li> <li>2. Correct the cause of the fault.</li> <li>3. If in error, review job prints. Check status of relevant inputs and outputs.</li> </ol>
<b>BATTERY POWER CAR RECALL ACTIVATED</b>
<p><b>Description:</b> Commercial power is not available at the elevator and a battery powered rescue device is recalling/moving the car to an appropriate floor for passenger egress. This may also be displayed during a test operation of the battery powered rescue device.</p> <p><b>Troubleshooting:</b> If in error:</p> <ol style="list-style-type: none"> <li>1. Check status of commercial power to elevator.</li> <li>2. Check proper operation of the battery powered rescue device.</li> <li>3. Review job prints. Check status of relevant inputs and outputs.</li> </ol>
<b>BOTTOM ACCESS SW. FAILURE</b>
<p><b>Description:</b> The Up and Down Bottom Access switch inputs are active at the same time.</p> <p><b>Troubleshooting:</b> Check the wiring and the switch associated with the ABU and ABD inputs.</p>

Table 5.1 Status and Error Messages

Scrolling Message - Special Event Message
<b>BOTTOM FLOOR OR TOP FLOOR DEMAND</b>
<p><b>Description:</b> The controller is trying to establish car position by sending it to either the top or the bottom. Usually associated with bottom floor demand. Bottom Floor Demand has four possible causes:</p> <ol style="list-style-type: none"> <li>1. A change from Inspection to Automatic operation.</li> <li>2. Pressing the COMPUTER RESET button.</li> <li>3. Initial Power-up.</li> <li>4. If the car is at the top floor and the controller gets an up slowdown signal (USD), the controller will create a Bottom Floor Demand.</li> </ol> <p><b>Troubleshooting:</b> Bottom Floor Demand should be cleared when all of the following conditions are met:</p> <ol style="list-style-type: none"> <li>1. The car is at the bottom and the down slowdown (DSD) input to the controller is <i>OFF</i> (because the switch should be open).</li> <li>2. The Door Zone (DZ) input to the controller is <i>ON</i>.</li> <li>3. The Door Lock (DLK) input to the controller is <i>ON</i>.</li> </ol> <p>If the car is at the bottom and the message still flashes, check the Down slowdown switch and associated wiring and the bottom floor door zone landing system vane/magnet and door lock circuit.</p> <p>Top Floor Demand should be cleared when all of the following conditions are met:</p> <ol style="list-style-type: none"> <li>1. Car is at the top and up slowdown (USD) input is <i>OFF</i> (because the switch should be open).</li> <li>2. The Door Zone (DZ) input to the controller is <i>ON</i>.</li> <li>3. The Door Lock (DLK) input to the controller is <i>ON</i>.</li> </ol> <p>If the car is at the top and the message still flashes, inspect the Up slowdown switch and associated wiring. Also inspect the door zone landing system vane/magnet at the top floor and the door lock circuit.</p>
<b>BRAKE MODULE FAULT LIMIT REACHED</b>
<p><b>Description:</b> The maximum number of consecutive FCL related faults has been reached. See FCL fault descriptions.</p> <p><b>Troubleshooting:</b> Requires fault reset on HC-CTL board.</p>
<b>BRAKE PICK FAILURE</b>
<p><b>Description:</b> The car is shut down because the brake pick switch, BPS, input was activated during three consecutive runs, indicating the brake was not fully picked (BPS is high).</p> <p><b>Troubleshooting:</b> In Program Mode (F1), check to see if any spare input is programmed as BPS, then check to see if that input is activated. Check the physical mounting of the switch.</p>
<b>BRP INPUT FAILED TO ACTIVATE</b>
<p><b>Description:</b> NC auxiliary contact for BR contactor failed to close. When idle, this input should be activated.</p> <p><b>Troubleshooting:</b></p> <ol style="list-style-type: none"> <li>1. Check BRP screw terminal on TC-MPI board for 120V. When BR contactor is picked, BRP should go low.</li> </ol>
<b>BRP INPUT FAILED TO DEACTIVATE</b>
<p><b>Description:</b> NC auxiliary contact for BR contactor failed to open. When running, this input should be at zero volts.</p> <p><b>Troubleshooting:</b></p> <ol style="list-style-type: none"> <li>1. Check BRP screw terminal on TC-MPI board for 120V. When BR contactor is dropped, BRP should go high.</li> </ol>
<b>CAPTURE FOR TEST</b>
<p><b>Description:</b> CTST input has been activated.</p> <p><b>Troubleshooting:</b> In Program Mode (F1), check the spare inputs to see if one is programmed as CTST, then ensure that input is NOT activated.</p>
<b>CAR CALL BUS IS DISCONNECTED</b>
<p><b>Description:</b> Indicates a problem in wiring or fuses. No power to the Car Call circuits.</p> <p><b>Troubleshooting:</b> Check the Car Call Bus fuse. Check the wires that go to the Car Call Power inputs in the controller.</p>

**Table 5.1 Status and Error Messages**

Scrolling Message - Special Event Message
<b>CAR DOOR BYPASS SW. FAILURE</b>
<p><b>Description:</b> Indicates that the car door bypass switch has failed.</p> <p><b>Troubleshooting:</b></p> <ol style="list-style-type: none"> <li>1. Cycle the HC-CTL board car door bypass switch a few times to exercise it. Verify that it is fully in the ON or OFF position.</li> <li>2. Verify 2S and GS connections and wiring.</li> </ol>
<b>CAR IN TEST MODE</b>
<p><b>Description:</b> The TEST input has been activated.</p> <p><b>Troubleshooting:</b> Check the TEST/NORM switch position on the HC-CTL Board.</p>
<b>CAR SAFETY DEVICE OPEN</b>
<p><b>Description:</b> One of the car safety devices has activated, opening the safety circuit (e.g., emergency exit contact, safety clamp switch, car-top emergency stop switch).</p> <p><b>Troubleshooting:</b> Refer to wiring prints and check all car safety devices. Verify that the SAF terminal on the HC-CTL board is powered.</p>
<b>CAR TO FLOOR FUNCTION</b>
<p><b>Description:</b> The CTF input has been activated.</p> <p><b>Troubleshooting:</b> In Program Mode (F1), see if a spare input is programmed as CTF, then check to see if that input is activated.</p>
<b>CAR TO LOBBY OPERATION</b>
<p><b>Description:</b> The CTL input has been activated.</p> <p><b>Troubleshooting:</b> In Program Mode (F1), see if a spare input is programmed as CTL, then check to see if that input is activated.</p>
<b>CAR TOP INSPECTION</b>
<p><b>Description:</b> The controller is currently in cartop inspection (120VAC detected at screw terminal INCT on the HC-CTL board).</p>
<b>CONFIGURATION ERROR-CHANGE SETTINGS BEFORE INSTALLATION</b>
<p><b>Description:</b> Incorrectly programmed value(s), e.g., a floor selected for the fire floor is not one at which the elevator stops or conflict with Duplex car. Check Duplex programming.</p> <p><b>Troubleshooting:</b> In Program Mode (F1), check all of the values associated with stops and special floors. Save the values.</p> <p>If this message reoccurs after cycling power to the controller, the memory backup battery on the HC-MPU board may be low. CR2032 battery voltage should about 3Vdc. If you replace the battery, be sure to default the parameters before reprogramming controller parameters. We recommend you replace the MPU battery every four years. Replace the battery with POWER ON.</p>
<b>CYCLE TEST</b>
<p><b>Description:</b> A cycle test (exercise operation) of the brake and motor contactors is conducted before the car is allowed to move from a landing. This message will be momentarily displayed while the cycle test completes.</p> <p><b>Troubleshooting:</b> Informational only.</p>
<b>DCAB INPUT FAILURE</b>
<p><b>Description:</b> The Bottom Access Door Contact (DCAB) input monitors the bottom door closed contacts. DCAB should be 120VAC during bottom access operation when the Bottom Access switch is toggled to the up or down position.</p> <p><b>Troubleshooting:</b></p> <ol style="list-style-type: none"> <li>1. Verify 120VAC on the 2S bus.</li> <li>2. Check that all hoistway doors are closed except for the bottom access hoistway door.</li> <li>3. Check for 120VAC on the DCAB terminal.</li> </ol>

Table 5.1 Status and Error Messages

Scrolling Message - Special Event Message
<p><b>DCLCR INPUT FAILURE</b></p> <p><b>Description:</b> The Rear Door Close Limit Contact (DCLCR) input monitors the rear door closed contacts. DCLCR should be 120VAC during bottom rear access operation when the Bottom Access switch is toggled to the up or down position. If your door operator connects to a UIO board on the car top (rather than up the traveler to the controller), check that the "spare" inputs used for door operation are correctly programmed and that Serial Cartop Door Control (4-16) is set properly. Also verify communication to UIO (if you have serial cartop door control) by placing F1 and F8 switches UP to view communication with boards.</p> <p><b>Troubleshooting:</b></p> <ol style="list-style-type: none"> <li>1. Verify 120VAC on the 2S bus.</li> <li>2. Check that all hoistway doors are closed except for the bottom rear access hoistway door.</li> <li>3. Check for 120VAC on the DCLCR terminal.</li> </ol>
<p><b>DL INPUT FAILURE</b></p> <p><b>Description:</b> The Door Lock (DL) input has detected a failure of the Hoistway Door Bypass (HDBA) or Bottom Access Bypass (BABA) outputs, Gate Switch (GS), Door Position Monitor (DPM), or Door Lock Access.</p> <p><b>Troubleshooting:</b></p> <ol style="list-style-type: none"> <li>1. Check voltage on HC-CTL board terminal DLAB. DPM should activate two inches before DLAB.</li> <li>2. If DL is active, GS must also be active.</li> </ol>
<p><b>DLR INPUT FAILURE</b></p> <p><b>Description:</b> The Rear Door Lock (DLR) input has detected a failure of the Rear Hoistway Door Bypass (HDBBR) or Rear Bottom Access Bypass (BABBR) outputs, Rear Gate Switch (GSR), Rear Door Position Monitor (DPMR), or Rear Door Lock Access Bypass (DLABR) inputs.</p> <p><b>Troubleshooting:</b></p> <ol style="list-style-type: none"> <li>1. Check voltage on HC-RDR board terminal DLABR. DPMR should activate two inches before DLABR.</li> <li>2. If DLR is active, GSR must also be active.</li> </ol>
<p><b>DOL INPUT FAILURE</b></p> <p><b>Description:</b> The Door Open Limit (DOL) input is not in the correct state for the position of the door as indicated by the Door Position Monitor (DPM) and Gate Switch (GS) inputs. If your door operator connects to a UIO board on the car top (rather than up the traveler to the controller), check that the "spare" inputs used for door operation are correctly programmed and that Serial Cartop Door Control (4-16) is set properly. Also verify communication to UIO (if you have serial cartop door control) by placing F1 and F8 switches UP to view communication with boards.</p> <p><b>Troubleshooting:</b></p> <ol style="list-style-type: none"> <li>1. If DPM is high, DOL must also be high. Check wiring to HC-CTL board terminal DOL.</li> <li>2. If the GS input is high, DOL must also be high. Check wiring to terminal DOL.</li> </ol>
<p><b>DOLR INPUT FAILURE</b></p> <p><b>Description:</b> The Rear Door Open Limit (DOLR) input is not in the correct state for the position of the door as indicated by the Rear Door Position Monitor (DPMR) and Rear Gate Switch (GSR) inputs. If your door operator connects to a UIO board on the car top (rather than up the traveler to the controller), check that the "spare" inputs used for door operation are correctly programmed and that Serial Cartop Door Control (4-16) is set properly. Also verify communication to UIO (if you have serial cartop door control) by placing F1 and F8 switches UP to view communication with boards.</p> <p><b>Troubleshooting:</b></p> <ol style="list-style-type: none"> <li>1. If DPMR is high, DOLR must also be high. Check wiring to terminal DOLR on the HC-RDR board.</li> <li>2. If the GSR input is high, DOLR must also be high. Check wiring to terminal DOLR.</li> </ol>

**Table 5.1 Status and Error Messages**

Scrolling Message - Special Event Message
<b>DOOR CLOSE PROTECTION TIMER ELAPSED</b>
<p><b>Description:</b> Failure to lock the doors detected. This condition exists when the doors have closed (DCLC = 1 or DCL = 0/DPM=1) and demand exists for the car to move (DCP=1), but the doors have not locked (DLK = 0) within 60 seconds.</p> <p><b>Troubleshooting:</b> If the Retiring Cam option is set, verify the Retiring Cam relay is activated (DCP=1, DCL=0/DPM=1 or DCLC=1) and the doors lock (DLK=1). If no Retiring Cam is used, verify door lock contacts are closed to provide power to the door lock input (DLK=1). When a predetermined number of sequential failures is detected (default is four), the car will shut down. The failure will be reset once the doors are locked (DLK=1), the car is placed on Inspection, or the Computer Reset Button is pressed.</p>
<b>DOOR ZONE SENSOR FAILURE - OFF POSITION</b>
<p><b>Description:</b> Indicates that the car completed a run but did not detect a door zone.</p> <p><b>Troubleshooting:</b> Reset by pressing the Fault Reset button or by toggling MACHINE ROOM INSPECTION INSP/NORM switch. Run the car to the same floor and verify that DZ=1 or DZR=1.</p> <ol style="list-style-type: none"> <li>1. Check voltage at door zone input to CTL board and at DZFO output from MPI board as shown in your job prints. Make sure wiring between boards is correct.</li> </ol>
<b>DOOR ZONE SENSOR FAILURE - ON POSITION</b>
<p><b>Description:</b> One of the DZ inputs (front or rear) did not transition to the low state during the last run. Probable cause may be:</p> <ol style="list-style-type: none"> <li>1. A faulty door zone sensor or associated circuitry (within the landing system assembly).</li> <li>2. Faulty wiring from the landing system to the controller.</li> <li>3. Faulty computer input circuit (HC-CTL Control board).</li> </ol> <p><b>Troubleshooting:</b> Check door zone sensor operation and wiring. (Place car on inspection, move car away from the floor, noting the transitions in the door zone signal(s) coming from the landing system.) Verify that the computer diagnostic display of DZ (or DZ rear) matches the state of the sensor signals at the HC-CTL Control board (or HC-RDR Rear Door board). If these zones are virtual, check programming (F7, Parameters Adjust).</p> <ol style="list-style-type: none"> <li>1. Check voltage at door zone input to CTL board and at DZFO output from MPI board as shown in your job prints. Make sure wiring between boards is correct.</li> </ol>
<b>DPM REDUNDANCY FAULT</b>
<p><b>Description:</b> Front door input, relay, or associated circuitry failure detected. Valid when SAF is on. DLK and DPM must always be in the same state. If your door operator connects to a UIO board on the car top (rather than up the traveler to the controller), check that the "spare" inputs used for door operation are correctly programmed and that Serial Cartop Door Control (4-16) is set properly. Also verify communication to UIO (if you have serial cartop door control) by placing F1 and F8 switches UP to view communication with boards.</p> <p><b>Troubleshooting:</b></p> <ol style="list-style-type: none"> <li>1. Check that DPM makes (120VAC) 1 to 2 inches prior to door lock.</li> <li>2. If so, check associated circuitry.</li> </ol>
<b>DPMR REDUNDANCY FAULT</b>
<p><b>Description:</b> Rear door input, relay, or associated circuitry failure detected. Valid when SAF is on. DLK and DPMR must always be in the same state. If your door operator connects to a UIO board on the car top (rather than up the traveler to the controller), check that the "spare" inputs used for door operation are correctly programmed and that Serial Cartop Door Control (4-16) is set properly. Also verify communication to UIO (if you have serial cartop door control) by placing F1 and F8 switches UP to view communication with boards.</p> <p><b>Troubleshooting:</b></p> <ol style="list-style-type: none"> <li>1. Check that DPMR makes (120VAC) 1 to 2 inches prior to door lock.</li> <li>2. If so, check associated circuitry.</li> </ol>

Table 5.1 Status and Error Messages

Scrolling Message - Special Event Message
<b>DRIVE FAULT</b>
<p><b>Description:</b> This fault indicates that the controller has detected a DFLT input. The car will perform an emergency stop with the motor contactor and brake contactor immediately dropped.</p> <p><b>Troubleshooting:</b></p> <ol style="list-style-type: none"> <li>1. Examine the drive for faults.</li> </ol>
<b>DRIVE RX COMM FAILURE</b>
<p><b>Description:</b> Serial data from drive to TC-MPI board connector J27 has failed.</p> <p><b>Troubleshooting:</b></p> <ol style="list-style-type: none"> <li>1. Check connection and cable integrity from TC-MPI board J27 to drive.</li> <li>2. Reset C processor on TC-MPI board.</li> <li>3. Use a scope to check if data is in fact being transmitted from the drive.</li> </ol>
<b>DRIVE TX COMM FAILURE</b>
<p><b>Description:</b> Serial data from TC-MPI board connector J27 to drive has failed.</p> <p><b>Troubleshooting:</b></p> <ol style="list-style-type: none"> <li>1. Check connection and cable integrity from TC-MPI board J27 to drive.</li> <li>2. Reset C processor on TC-MPI board.</li> <li>3. Use a scope to check if data is in fact being transmitted from the board.</li> </ol>
<b>EARTHQUAKE OPERATION</b>
<p><b>Description:</b> The EQI and/or CWI input is/are active. The car is on earthquake operation.</p> <p><b>Troubleshooting:</b> If there has been no seismic activity, check the status of the EQI and CWI inputs. Check the counterweight derailment detection sensor. Check the seismic activity sensor.</p>
<b>ELEVATOR SHUTDOWN SWITCH ACTIVE</b>
<p><b>Description:</b> The ESS input has been activated.</p> <p><b>Troubleshooting:</b> In Program Mode (F1), see if a spare input is programmed as ESS, then check to see if that input is activated.</p>
<b>EMERGENCY BRAKE ACTIVATED</b>
<p><b>Description:</b> The emergency brake has applied (rope gripper/sheave brake/machine emergency brake).</p> <p><b>Troubleshooting:</b> Informational only.</p>
<b>EMERGENCY MEDICAL SERVICE</b>
<p><b>Description:</b> The EMSG or EMSA input has been activated.</p> <p><b>Troubleshooting:</b> Ensure that the MASSACHUSETTS EMS SERVICE option is set correctly. If not required, set to NO and ensure that the EMSG and EMSA inputs are <b>not</b> programmed as spare inputs. If EMS is required, set this option to the floor the car should return to when the EMSG input is activated.</p>
<b>EMERGENCY POWER OPERATION</b>
<p><b>Description:</b> The car is on Emergency Power operation (EPI is low).</p> <p><b>Troubleshooting:</b> Check that the Emergency Power operation option is set correctly. If emergency power is not required, set to NO and ensure that the EPI input is <b>not</b> programmed. If it is required, set this option to the floor the car should return to on Emergency Power and program the EPI input.</p>
<b>ENTER SECURITY CODE</b>
<p><b>Description:</b> MCE Security has been initiated.</p> <p><b>Troubleshooting:</b> Enter floor passcode on the C.O.P. within 10 seconds. <a href="#">Refer to section 4</a> for instructions on how to program security passcodes.</p>

**Table 5.1 Status and Error Messages**

Scrolling Message - Special Event Message
<b>FCL 1 - 4 - AUX IGBT STUCK CLOSED</b>
<p><b>Description:</b> The addressed brake module auxiliary IGBT is stuck in the closed position. This fault is triggered if the voltage across the Aux IGBT is insufficient to activate the monitoring circuit during dissipate mode. The car will stop at the next destination. Three consecutive occurrence faults reset automatically after 8 seconds. If the module consecutively faults again, fault "Brake Module Fault Limit Reached" is issued and must be reset on the HC-CTL board.</p> <p><b>Troubleshooting:</b></p> <ol style="list-style-type: none"> <li>1. Slow the brake drop rate slightly using module potentiometer R70 (discrete control) or F7 parameter 198 (CAN control). (The brake may be dropping too rapidly for the voltage sensing to work properly.)</li> <li>2. Contact MCE to verify the resistor/capacitor values of the external dissipate circuit. Too much capacitance on a small brake may cause this fault.</li> </ol>
<b>FCL 1 - 4 - AUX IGBT STUCK OPEN</b>
<p><b>Description:</b> The addressed brake module auxiliary IGBT is stuck in the open position. This fault is triggered if the brake is in pick, hold, or relevel mode and the monitoring circuit returns a high signal for 100mS or more. The car will stop at the next landing. The first and second consecutive occurrence faults reset automatically after 8 seconds. If the module consecutively faults again, fault "Brake Module Fault Limit Reached" is issued and must be reset on the HC-CTL board.</p> <p><b>Troubleshooting:</b> Replace the brake module.</p>
<b>FCL 1 - 4 - BYPASS BUTTON STUCK CLOSED</b>
<p><b>Description:</b> The addressed brake module is in manual release mode and the bypass button/switch appears to be stuck in the closed position.</p> <p><b>Troubleshooting:</b> Please see <a href="#">"SW1, Manual Bypass" on page 5-77</a> to see if manual release mode is enabled. Check the manual brake release switch connections and operation. If the problem persists, replace the brake module.</p>
<b>FCL 1 - 4 - CAN DISCONNECTED</b>
<p><b>Description:</b> The addressed brake module CAN connection appears to be disconnected.</p> <p><b>Troubleshooting:</b></p> <ol style="list-style-type: none"> <li>1. Check the CAN connection and the CAN cable. Temporarily swap out the cable to eliminate the possibility that the cable is faulty.</li> <li>2. Check that module CAN termination jumper JP1 is open.</li> <li>3. Replace the brake module.</li> </ol>
<b>FCL 1 - 4 - DISCRETE INPUT WHILE IN CAN MODE</b>
<p><b>Description:</b> The addressed brake module is receiving a discrete command input while in CAN mode.</p> <p><b>Troubleshooting:</b></p> <ol style="list-style-type: none"> <li>1. Check that F7, parameter 185 brake configuration is properly set.</li> <li>2. Check that no discrete control voltages have been incorrectly applied. <a href="#">Please refer to "Configuration" on page 5-76.</a></li> </ol>
<b>FCL 1 - 4 IN MANUAL MODE</b>
<p><b>Description:</b> The addressed brake module has been placed in manual mode (will cause Main IGBT stuck open fault to be indicated until the brake contactor is picked to allow power to the brake module). In this mode, a manual brake release switch connected between BRBP1 and BRBP3 will energize the brake coil connected between BRBP2 and BRBP4 and immediately lift the brake regardless of the status of the elevator controller.</p> <p><b>Troubleshooting:</b>                      Informational only.</p>



Table 5.1 Status and Error Messages

Scrolling Message - Special Event Message
<b>FCL 1 - 4 LOAD EXTREME UNDER CURRENT</b>
<p><b>Description:</b> The addressed brake module has detected that delivered current is less than 40% of the learned operating current. The car will stop at the next landing. First and second consecutive occurrence faults reset automatically after 8 seconds. If the module consecutively faults again, fault "Brake Module Fault Limit Reached" is issued and must be reset on the HC-CTL board.</p> <p><b>Troubleshooting:</b> Check the brake for proper operation according to manufacturer specifications.</p>
<b>FCL 1 - 4 LOAD EXTREME UNDER VOLTAGE</b>
<p><b>Description:</b> The addressed brake module has detected delivered voltage is less than 40% of the learned operating voltage. The car will stop at the next landing. First and second consecutive occurrence faults reset automatically after 8 seconds. If the module consecutively faults again, fault "Brake Module Fault Limit Reached" is issued and must be reset on the HC-CTL board.</p> <p><b>Troubleshooting:</b> Check the brake for proper operation according to manufacturer specifications.</p>
<b>FCL 1 - 4 - LOAD OVER CURRENT</b>
<p><b>Description:</b> The addressed brake module has detected excessive current conditions (&gt;20 A for 5 seconds or more). Current will be automatically limited to 20A when this fault is issued. The car will stop at the next landing. Three consecutive occurrence faults reset automatically after 8 seconds. If the module consecutively faults again, fault "Brake Module Fault Limit Reached" is issued and must be reset on the HC-CTL board.</p> <p><b>Troubleshooting:</b></p> <ol style="list-style-type: none"> <li>1. Check for a shorted brake control wire.</li> <li>2. Check that the brake does not require more current than 20A. If so, a second module may be required in tandem with the first to handle current requirements.</li> </ol>
<b>FCL 1 - 4 - LOAD OVER VOLTAGE</b>
<p><b>Description:</b> The addressed brake module has detected excessive voltage conditions (&gt;310 VDC for 5 seconds or more). Voltage will be automatically limited to 310 VDC when this fault is issued. The car will stop at the next landing. Three consecutive occurrence faults reset automatically after 8 seconds. If the module consecutively faults again, fault "Brake Module Fault Limit Reached" is issued and must be reset on the HC-CTL board.</p> <p><b>Troubleshooting:</b></p> <ol style="list-style-type: none"> <li>1. Check that the brake is operating properly.</li> <li>2. Check that the brake springs are correctly torqued.</li> </ol>
<b>FCL 1 - 4 - LOAD UNDER CURRENT</b>
<p><b>Description:</b> The addressed brake module has detected delivered current is less than 80% of the learned operating current. The car will stop at the next destination. Three consecutive occurrence faults reset automatically after 8 seconds. If the module consecutively faults again, fault "Brake Module Fault Limit Reached" is issued and must be reset on the HC-CTL board.</p> <p><b>Troubleshooting:</b> Check the brake for proper operation according to manufacturer specifications.</p>
<b>FCL 1 - 4 - LOAD UNDER VOLTAGE</b>
<p><b>Description:</b> The addressed brake module has detected that delivered voltage is less than 80% of the learned operating voltage. The car will stop at the next destination. Three consecutive occurrence faults reset automatically after 8 seconds. If the module consecutively faults again, fault "Brake Module Fault Limit Reached" is issued and must be reset on the HC-CTL board.</p> <p><b>Troubleshooting:</b> Check the brake for proper operation according to manufacturer specifications.</p>

**Table 5.1 Status and Error Messages**

Scrolling Message - Special Event Message
<b>FCL 1 - 4 - MAIN IGBT STUCK CLOSED</b>
<p><b>Description:</b> If the brake is not in pick, hold, relevel, or dissipate mode and there is more than 40 volts or 200 milliamps across the brake coil for 200 mS or more, the IGBT stuck closed fault will occur. In CAN mode, this fault resets automatically after 8 seconds.</p> <p><b>Troubleshooting:</b> Check that manual brake pick is not enabled. <a href="#">Please refer to "SW1, Manual Bypass" on page 5-77.</a></p>
<b>FCL 1 - 4 - MAIN IGBT STUCK OPEN</b>
<p><b>Description:</b> If the brake is in pick, hold, or relevel mode and there is less than 20 volts or 100mA across the coil for 200 mS or more, the IGBT stuck open fault will occur. The car will stop at the next landing. The first and second consecutive occurrence faults reset automatically after 8 seconds. If the module consecutively faults again, fault "Brake Module Fault Limit Reached" is issued and must be reset on the HC-CTL board.</p> <p><b>Troubleshooting:</b></p> <ol style="list-style-type: none"> <li>1. Check the brake for proper operation according to manufacturer specifications.</li> <li>2. Verify that the BR contactor supplies the module with sufficient voltage when the Pick command is sent.</li> </ol>
<b>FCL 1 - 4 - MODULE ADDRESS ERROR</b>
<p><b>Description:</b> A brake module address conflict has been detected. The car will stop at the next destination. Three consecutive occurrence faults reset automatically after 8 seconds. If the module consecutively faults again, fault "Brake Module Fault Limit Reached" is issued and must be reset on the HC-CTL board.</p> <p><b>Troubleshooting:</b> Verify SW3 positions for each module. <a href="#">Please refer to "SW3 Module ID and Software Features" on page 5-78.</a></p>
<b>FCL 1 - 4 - MODULE OVERHEAT</b>
<p><b>Description:</b> The IGBT units on the bottom of the TC-FCP board generate heat when operating. A thermal sensor on the heat sink is connected to the module logic board through the TS1 and TS2 inputs. If the temperature becomes excessive, the logic module will generate a fault, pulling the FLT output to the Common connection level and alerting the controller.</p> <p><b>Troubleshooting:</b></p> <ol style="list-style-type: none"> <li>1. The fault will reset when the module cools.</li> <li>2. If this is a recurring event, check the brake for proper operation. Check that brake pick and hold voltages are correct. <a href="#">Please refer to "FCL Power Data Menu" on page 4-96.</a></li> </ol>
<b>FCL 1 - 4 - NOT CALIBRATED</b>
<p><b>Description:</b> The addressed module is not calibrated to operate with the Motion 4000 system.</p> <p><b>Troubleshooting:</b> Calibrate the module. <a href="#">Please refer to "Calibration (CAN Only)" on page 5-82.</a></p>
<b>FCL 1 - 4 - TRYING TO RUN IN MANUAL RELEASE MODE</b>
<p><b>Description:</b> Module is in manual release mode and the controller is attempting to run the car which involves operating the brake.</p> <p><b>Troubleshooting:</b> Disable manual release mode. <a href="#">Please refer to "SW1, Manual Bypass" on page 5-77.</a></p>
<b>FIRE SERVICE PHASE 1 - ALTERNATE</b>
<p><b>Description:</b> The car is returning to an alternate fire return landing. The FRS input is low and the FRA input is high or FRAON is active.</p> <p><b>Troubleshooting:</b> Inspect the fire sensors (especially the main floor sensor) and Fire Phase I switch wiring. For some fire codes, including ASME, the Fire Phase I switch must be turned to the <i>BYPASS</i> position and then back to <i>OFF</i> to clear the fire service status once activated.</p>

Table 5.1 Status and Error Messages

Scrolling Message - Special Event Message
<b>FIRE SERVICE PHASE 1 - MAIN</b>
<p><b>Description:</b> The car is returning to the main fire return landing. The FRS input is low or the FRON or FRON2 inputs are high.</p> <p><b>Troubleshooting:</b> Inspect fire sensors and Fire Phase I switch wiring. For some fire codes, including ASME, the Fire Phase I switch must be turned to the <i>BYPASS</i> position and then back to <i>OFF</i> to clear the fire service status once activated.</p>
<b>FIRE SERVICE PHASE 2</b>
<p><b>Description:</b> The FCS controller input is <i>ON</i>.</p> <p><b>Troubleshooting:</b> Inspect the phase 2 switch and wiring. In some cases, to exit Fire Service Phase 2, the car must be at the fire floor at which Fire Phase 2 was activated, the doors must be fully open, and the phase 2 switch must be off (the FCOFF input must be activated) to exit phase 2.</p>
<b>FRONT DOL AND DLK ARE BOTH ACTIVE</b>
<p><b>Description:</b> A critical failure has caused both the Door Open Limit and Door Lock inputs to be active at the same time.(DOL=0 &amp; DLK=1). There is a problem with DOL and/or DLK circuitry or wiring.</p> <p><b>Troubleshooting:</b> Inspect the Door Open Limit and the Door Lock circuitry and wiring. When this error is generated, the car will shut down with the doors open and will not answer any calls. The only way to reset this error condition is to put the car on Inspection operation.</p>
<b>FRONT DOOR FAILED TO CLOSE</b>
<p><b>Description:</b> Doors Open (DCL = 1). There is a problem with DCL circuitry or wiring.</p> <p><b>Troubleshooting:</b> Inspect the Door Closed Limit circuitry and wiring. When this error is generated, the car is not allowed to run.</p>
<b>FRONT DOOR IS LOCKED BUT NOT FULLY CLOSED</b>
<p><b>Description:</b> Doors Open (DCL = 1) and Locked (DLK = 1). There is a problem with DCL and/or DLK circuitry or wiring.</p> <p><b>Troubleshooting:</b> Inspect the Door Closed Limit and the Door Lock circuitry and wiring. When this error is generated, the car is not allowed to run.</p>
<b>FRONT DOOR LOCK SWITCH FAILURE</b>
<p><b>Description:</b> The front door lock contacts have failed closed.</p> <p><b>Troubleshooting:</b> Ensure that, with the front hoistway doors closed and locked, there is power on the DLS input and no power present on the DCL input.</p>
<b>FRONT DOOR OPEN LIMIT FAILURE</b>
<p><b>Description:</b> The door open limit switch has failed open.</p> <p><b>Troubleshooting:</b> Ensure that the car gate is open, there is no power on the DOL input, and no power present on the DLS or CD inputs.</p>
<b>FRONT DZ RELAY DISCREPANCY</b>
<p><b>Description:</b> HC-CTL door zone input and door zone flag from TC-MPI board do not match. The elevator will stop at the next floor in the direction of travel and shut down until the fault is cleared (HC-CTL fault reset or toggle Inspection switch).</p> <p><b>Troubleshooting:</b></p> <ol style="list-style-type: none"> <li>1. Verify door zone (virtual if ELGO system, magnet if LS-EDGE) input. Reset A, B, and C processors on TC-MPI board.</li> <li>2. Verify connection between MPI board DZFO and CTL board DZF.</li> </ol>
<b>FRONT GATE SWITCH FAILURE</b>
<p><b>Description:</b> The front car gate switch has failed closed.</p> <p><b>Troubleshooting:</b> Ensure that, with the front car gate closed, there is power on the GS input and no power present on the DCL input.</p>

**Table 5.1 Status and Error Messages**

Scrolling Message - Special Event Message
<b>GOVERNOR SWITCH OPEN</b>
<b>Description:</b> The overspeed governor has activated, opening the safety circuit. <b>Troubleshooting:</b> Check the overspeed governor.
<b>GROUP TO CAR COMMUNICATION LOSS</b>
<b>Description:</b> The car controller has detected a loss of communication with the group controller. <b>Troubleshooting:</b> <ol style="list-style-type: none"> <li>1. Verify that the group controller MCP board is functioning properly. Reset if necessary.</li> <li>2. Verify that SW1, switch 4 is set to OFF on the group controller HC-CHP board (determines communication baud rate).</li> <li>3. Check the CAN cable between External Network connector J4 on the car MC-MPU board and External Network connector J17 on the group HC-CHP board.</li> <li>4. Check polarity of the CAN connection (CANH/CANH and CANL/CANL).</li> </ol>
<b>GS INPUT FAILURE</b>
<b>Description:</b> The Gate Switch (GS) input has detected a failure of the ABGA or GBB outputs, DPM, DLAB, or the gate switch. <b>Troubleshooting:</b> <ol style="list-style-type: none"> <li>1. Check the gate switch. DPM should activate two inches before the gate switch.</li> <li>2. If GS is active, DLAB must also be active.</li> </ol>
<b>GSR INPUT FAILURE</b>
<b>Description:</b> The Rear Gate Switch (GSR) input has detected a failure of the ABGAR or RABA outputs, DPMR, DLABR, or the rear gate switch. <b>Troubleshooting:</b> <ol style="list-style-type: none"> <li>1. Check the gate switch. DPMR should activate two inches before the gate switch.</li> <li>2. If GSR is active, DLABR must also be active.</li> </ol>
<b>HALL AND CAR CALL BUSES DISCONNECTED</b>
<b>Description:</b> A fuse or wiring problem has stopped power to the call circuits. <b>Troubleshooting:</b> Check call bus fuses. Check the wires that go to the call power outputs in the controller.
<b>HALL CALL BUS IS DISCONNECTED</b>
<b>Description:</b> A fuse or wiring problem has stopped power to hall call circuits. <b>Troubleshooting:</b> Check the hall call bus fuse and the wires to the hall call power inputs in the controller.
<b>HEAVY LOAD WEIGHER CONDITION</b>
<b>Description:</b> The HLI input has been activated. <b>Troubleshooting:</b> In Program Mode, see if a spare input is programmed as an HLI input, then check to see if that input is activated.
<b>HOISTWAY ACCESS</b>
<b>Description:</b> Hoistway access is active. <b>Troubleshooting:</b> Informational only.
<b>HOISTWAY DOOR BYPASS SW. FAILURE</b>
<b>Description:</b> The expected input logic from the HOISTWAY DOOR BYPASS switch has failed. <b>Troubleshooting:</b> <ol style="list-style-type: none"> <li>1. Cycle the HC-CTL board hoistway door bypass switch a few times to exercise it. Verify that it is fully in the ON or OFF position.</li> <li>2. Verify 2S and DLAB connections and wiring.</li> </ol>

Table 5.1 Status and Error Messages

Scrolling Message - Special Event Message
<b>HOISTWAY SAFETY DEVICE OPEN</b>
<p><b>Description:</b> One of the hoistway safety devices has activated, opening the safety circuit (e.g., pit stop switch, car and counterweight buffer switches, up/down final limit switches).</p> <p><b>Troubleshooting:</b> Check all hoistway safety devices. Refer to controller wiring prints for applicable devices. Verify that the SAFH terminal on the HC-CTL board is powered.</p>
<b>HOSPITAL PHASE 1 OPERATION</b>
<p><b>Description:</b> A hospital emergency call switch is activated.</p> <p><b>Troubleshooting:</b> Check that the hospital emergency operation option is set correctly. If hospital emergency operation is not required, set to no. If required, set floors eligible to answer a hospital call to yes.</p>
<b>HOSPITAL PHASE 2 OPERATION</b>
<p><b>Description:</b> The car has answered a hospital emergency call or the in-car hospital emergency key switch has been activated (HOSP is high).</p> <p><b>Troubleshooting:</b> Check that the hospital emergency operation option is set correctly, then check to see if any spare inputs are programmed as HOSP and if they are activated.</p>
<b>ICPD INPUT FAILURE</b>
<p><b>Description:</b> The Car Panel Inspection Down (ICPD) input is high while the 2 bus is low.</p> <p><b>Troubleshooting:</b></p> <ol style="list-style-type: none"> <li>1. Check for incorrect wiring or short on the HC-CTL board ICPD input and 2 bus.</li> </ol>
<b>ICPU INPUT FAILURE</b>
<p><b>Description:</b> The Car Panel Inspection Up (ICPU) input is high while the 2 bus is low.</p> <p><b>Troubleshooting:</b></p> <ol style="list-style-type: none"> <li>1. Check for incorrect wiring or short on the HC-CTL board ICPU input and 2 bus.</li> </ol>
<b>ICTD INPUT FAILURE</b>
<p><b>Description:</b> The Car Top Inspection Down (ICTD) input is high while the SAFH bus is low.</p> <p><b>Troubleshooting:</b></p> <ol style="list-style-type: none"> <li>1. Check for incorrect wiring or short on the HC-CTL board ICTD input.</li> </ol>
<b>ICTU INPUT FAILURE</b>
<p><b>Description:</b> The Car Top Inspection Up (ICTU) input is high while the SAFH bus is low.</p> <p><b>Troubleshooting:</b></p> <ol style="list-style-type: none"> <li>1. Check for incorrect wiring or short on the HC-CTL board ICTU input.</li> </ol>
<b>INA INPUT FAILURE</b>
<p><b>Description:</b> The INA (COP access enable switch) input did not receive a signal when expected.</p> <p><b>Troubleshooting:</b></p> <ol style="list-style-type: none"> <li>1. Check for incorrect wiring or short on the HC-CTL board INA input and 2 bus.</li> <li>2. Check access enable switch in COP and connection through traveler.</li> </ol>
<b>IN-CAR INSPECTION</b>
<p><b>Description:</b> The controller is currently on IN-CAR inspection, activated by 120VAC at screw terminal INCP on the HC-CTL board.</p>
<b>IN CAR STOP SWITCH ACTIVATED</b>
<p><b>Description:</b> The in-car stop switch has been pulled, opening the safety circuit.</p> <p><b>Troubleshooting:</b> Check the status of the in-car emergency stop switch.</p>
<b>INCP INPUT FAILURE</b>
<p><b>Description:</b> The Car Panel Inspection INSP/Auto Switch input (INCP) is high while the 2 bus is low.</p> <p><b>Troubleshooting:</b></p> <ol style="list-style-type: none"> <li>1. Check for incorrect wiring or short on the HC-CTL board INCP input and 2 bus.</li> </ol>

**Table 5.1 Status and Error Messages**

Scrolling Message - Special Event Message
<b>INCT INPUT FAILURE</b>
<b>Description:</b> The Car Top Inspection INSP/AUTO Switch input (INCT) is high while SAFH is low. <b>Troubleshooting:</b> 1. Check for incorrect wiring or short on the HC-CTL board INCT input and SAFH or 2 bus.
<b>INDEPENDENT SERVICE OPERATION</b>
<b>Description:</b> The Independent Service switch inside the car has been turned on. <b>Troubleshooting:</b> If unintended, check the Independent Service switch.
<b>INSPECTION DIRECTION SW. FAILURE</b>
<b>Description:</b> Both UP and DN Machine Room Inspection directions are active at the same time. <b>Troubleshooting:</b> 1. Exercise the HT-CTL board Inspection direction switch. Verify that it remains in the middle when released. 2. Check status of UP and DOWN indicator LEDs.
<b>INSPECTION OPERATION</b>
<b>Description:</b> The car is on Inspection operation. <b>Troubleshooting:</b> If unintended, check all inspection switches and associated wiring.
<b>LEVELING DOWN</b>
<b>Description:</b> The Level Down input is ON. This input is normally ON when the car is just above a floor. <b>Troubleshooting:</b> Check F7 programming. Check LS-EDGE sensor.
<b>LEVELING UP</b>
<b>Description:</b> The Level Up input is ON. This input is normally ON when the car is just below a floor. <b>Troubleshooting:</b> Check F7 programming. Check LS-EDGE sensor.
<b>LIGHT LOAD WEIGHER CONDITION</b>
<b>Description:</b> The Light Load Weighing input is activated. <b>Troubleshooting:</b> Ensure that Light Load Weighing is required. If not, set the Light Load Weighing option to NO and ensure that the LLI input is not programmed. If Light Load Weighing is required, ensure that the Light Load Car Call Limit is set to the correct number of stops.
<b>LOSS OF DOOR LOCK OUT OF DOOR ZONE</b>
<b>Description:</b> Door lock lost with elevator outside of door zone (i.e., outside of door zone and leveling). May also be generated at speed if the door locks are clipped. <b>Troubleshooting:</b> Inspect door lock circuitry and wiring. Check for any mechanical contact with gate switch or door clutch (if restrictor used) and hoistway components.
<b>LS-EDGE LEARN MODE ACTIVE</b>
<b>Description:</b> The LS-EDGE hoistway learn procedure is active. <b>Troubleshooting:</b> Informational only.
<b>M2L INPUT FAILURE</b>
<b>Description:</b> The M2L input monitors the status of the relay contacts of SAFL and SAFS against the circuits that drive these relay coils. Bus 2L should be 120VAC and relay SAFL should be picked only if the doors are locked. 2MV bus must also be active. The M2L input is verified when the PM contactor is energized. <b>Troubleshooting:</b> 1. Check or replace relays SAFL and/or SAFS on the HC-CTL board. 2. Verify that IDC terminal 2L on the HC-CTL board connects to IDC terminal 2L on the TC-MPI board.

Table 5.1 Status and Error Messages

Scrolling Message - Special Event Message
<b>MABB INPUT FAILURE</b>
<p><b>Description:</b> The Bottom Access Bypass Monitor (door close contacts) (MABB) input monitors operation of the solid state devices associated with bypassing bottom hoistway door contacts during access operation.</p> <p><b>Troubleshooting:</b> Remove the car from access operation and verify that test point TP41 (MABB) on the HC-CTL board is low with respect to 1 bus.</p>
<b>MABBR INPUT FAILURE</b>
<p><b>Description:</b> The Bottom Rear Access Monitor (door close contacts) (MABBR) input monitors operation of the solid state devices associated with bypassing bottom rear hoistway door contacts during access operation.</p> <p><b>Troubleshooting:</b> Remove the car from access operation and verify that test point TP43 (MABBR) on the HC-RDR board is low with respect to 1 bus.</p>
<b>MABGF INPUT FAILURE</b>
<p><b>Description:</b> The Front Access Gate Bypass Monitor (MABGF) input has detected a failure of the Access Bypass Gate A (ABGA) or Front Access Bypass Bottom (FABB) outputs.</p> <p><b>Troubleshooting:</b></p> <ol style="list-style-type: none"> <li>1. Temporarily disconnect then reconnect the CAN connection to the HC-CTL board to reset the microprocessors.</li> <li>2. Verify that SPA, SPB, and SPC LEDs are all lighted.</li> <li>3. If this failure occurred while updating software, refer to the update instructions and repeat the process.</li> </ol>
<b>MABGR INPUT FAILURE</b>
<p><b>Description:</b> The Rear Access Gate Bypass Monitor (MABGR) input has detected a failure of the Rear Access Bypass Gate A (ABGAR) or Rear Access Bypass (RABA) outputs.</p> <p><b>Troubleshooting:</b></p> <ol style="list-style-type: none"> <li>1. Temporarily disconnect then reconnect the CAN connection to the HC-RDR board to reset the microprocessors.</li> <li>2. Verify that SPA and SPB LEDs are lighted.</li> <li>3. If this failure occurred while updating software, refer to the update instructions and repeat the process.</li> </ol>
<b>MABT INPUT FAILURE</b>
<p><b>Description:</b> The Top Access Bypass Monitor (door close contacts) (MABT) input monitors operation of the solid state devices associated with bypassing the top hoistway door contacts during access operation.</p> <p><b>Troubleshooting:</b> Remove the car from access operation and verify that test point TP33 (MABT) on the HC-CTL board is low with respect to 1 bus.</p>
<b>MABTR INPUT FAILURE</b>
<p><b>Description:</b> The Top Rear Access Bypass Monitor (MABTR) input monitors proper operation of the solid state devices associated with bypassing the top rear hoistway door contacts during access operation.</p> <p><b>Troubleshooting:</b> Remove the car from access operation and verify that test point TP42 (MABTR) on the HC-RDR board is low with respect to 1 bus.</p>
<b>MACHINE ROOM INSPECTION</b>
<p><b>Description:</b> The controller is in MACHINE ROOM inspection operation.</p>
<b>MBAB INPUT FAILURE</b>
<p><b>Description:</b> The Bottom Access Bypass Monitor (door lock contacts) (MBAB) input has detected a failure of the Bottom Access Bypass (BAB) or (BABA) outputs or the BAB input.</p> <p><b>Troubleshooting:</b></p> <ol style="list-style-type: none"> <li>1. Check wiring at HC-CTL board terminal BAB.</li> </ol>

**Table 5.1 Status and Error Messages**

Scrolling Message - Special Event Message
<b>MBABR INPUT FAILURE</b>
<p><b>Description:</b> The Bottom Rear Access Bypass monitor (door lock contacts) (MBABR) input has detected a failure of the Bottom Rear Access Bypass (BABR) or (BABAR) outputs or the BABR input.</p> <p><b>Troubleshooting:</b></p> <ol style="list-style-type: none"> <li>1. Check wiring at HC-RDR board terminal BABR.</li> <li>2. Check Access switches and proper wiring of access terminals (ABU, ABD).</li> </ol>
<b>MCSB INPUT FAILURE</b>
<p><b>Description:</b> The Car Stop Bypass Monitor (MCSB) input on the HC-CTL board is active while the car stop bypass circuit is not active.</p> <p><b>Troubleshooting:</b></p> <ol style="list-style-type: none"> <li>1. Verify wiring and connections at ESC and SAFC.</li> <li>2. Temporarily disconnect then reconnect the CAN connection to the HC-CTL board to reset the microprocessors.</li> <li>3. Verify that SPA, SPB, and SPC LEDs are all lighted.</li> <li>4. If this failure occurred while updating software, refer to the update instructions and repeat the process.</li> </ol>
<b>MDZLV INPUT FAILURE</b>
<p><b>Description:</b> The Door Zone/Leveling Monitor (MDZLV) input has detected a failure of the Door Zone/Leveling (DZLV) or (DZLVA) outputs or failure of the normally open DZ relay.</p> <p><b>Troubleshooting:</b> Replace relay DZ.</p>
<b>MGB INPUT FAILURE</b>
<p><b>Description:</b> Gate switch bypass circuit failure detected.</p> <p><b>Troubleshooting:</b></p> <ol style="list-style-type: none"> <li>1. Toggle the gate bypass switch on the HC-CTL board a few times, then make certain it is fully in the ON or OFF position.</li> <li>2. Briefly disconnect then reconnect CAN connection to CTL board to reset processors.</li> </ol>
<b>MGBR INPUT FAILURE</b>
<p><b>Description:</b> Rear gate switch bypass circuit failure detected.</p> <p><b>Troubleshooting:</b></p> <ol style="list-style-type: none"> <li>1. Toggle the gate bypass switch on the HC-RDR board a few times, then make certain it is fully in the ON or OFF position.</li> <li>2. Briefly disconnect then reconnect CAN connection to RDR board to reset processors.</li> </ol>
<b>MGS INPUT FAILURE</b>
<p><b>Description:</b> The Gate Switch Monitor (MGS) input has detected a failure of the gate switch or Door Zone/Door Zone Leveling (DZ/DZLVA) circuitry.</p> <p><b>Troubleshooting:</b></p> <ol style="list-style-type: none"> <li>1. Check gate switch condition.</li> <li>2. Replace relay GS.</li> <li>3. Replace relay DZ.</li> <li>4. With doors locked, check continuity between IDC terminals GS1 and GS2 on the HC-CTL board.</li> <li>5. If rear doors are present, check GSR.</li> </ol>



Table 5.1 Status and Error Messages

Scrolling Message - Special Event Message
<p><b>MGSR INPUT FAILURE</b></p> <p><b>Description:</b> The Rear Gate Switch Monitor (MGSR) input (test point TP48 (GSR2) on the HC-RDR board) has detected a failure of the rear gate switch or Door Zone/Door Zone Leveling (DZ/DZLVA) circuitry.</p> <p><b>Condition 1:</b> MGSR should be low during automatic operation when either the rear gate or rear hoistway doors are open as indicated by the GSR and DLR relays, except during re-leveling.</p> <p><b>Troubleshooting:</b></p> <ol style="list-style-type: none"> <li>1. If either relay GSR or DLR is not picked, verify that TP48 is low.</li> <li>2. Check continuity between terminals GS1 on the HC-CTL and GSR1 on the HC-RDR board and between terminals GS2 on the HC-CTL and GSR2 on the HC-RDR board.</li> </ol> <p><b>Condition 2:</b> If the car is re-leveling, and the front doors are closed, the MGSR input should have 120VAC.</p> <p><b>Troubleshooting:</b> Check continuity between terminals GS2 on the HC-CTL board and GSR2 on the HC-RDR board.</p> <p><b>Condition 3:</b> This fault is also generated if relays GSR and DLR are picked, indicating that the rear gate and hoistway doors are closed, but the MGSR input is low.</p> <p><b>Troubleshooting:</b></p> <ol style="list-style-type: none"> <li>1. Verify relays DLR and GSR are both picked.</li> <li>2. Verify 120VAC on terminals GSR1 and GSR2.</li> <li>3. Verify 120VAC on TP49 (MDLR) on the HC-RDR board.</li> <li>4. Verify 120VAC on TP48 (GSR2) on the HC-RDR board.</li> </ol>
<p><b>MHDB INPUT FAILURE</b></p> <p><b>Description:</b> The Hoistway Door Bypass Monitor (MHDB) input has detected a failure of the Hoistway Door Bypass (HDB) or (HDBA) outputs.</p> <p><b>Troubleshooting:</b></p> <ol style="list-style-type: none"> <li>1. Toggle the door bypass switch on the HC-CTL board a few times, then make certain it is fully in the ON or OFF position.</li> <li>2. Briefly disconnect then reconnect CAN connection to CTL board to reset processors.</li> </ol>
<p><b>MHDBR INPUT FAILURE</b></p> <p><b>Description:</b> The Rear Hoistway Door Bypass Monitor (MHDBR) input has detected a failure of the Rear Hoistway Door Bypass (HDBR) or (HDBBR) outputs.</p> <p><b>Troubleshooting:</b></p> <ol style="list-style-type: none"> <li>1. Toggle the door bypass switch on the HC-RDR board a few times, then make certain it is fully in the ON or OFF position.</li> <li>2. Briefly disconnect then reconnect CAN connection to RDR board to reset processors.</li> </ol>
<p><b>MOTOR LIMIT TIMER (ANTI-STALL) ELAPSED</b></p> <p><b>Description:</b> The Starter or Thermal Overload has tripped or there is a mechanical problem that prevents or slows motion of the car.</p> <p><b>Troubleshooting:</b> To clear the condition, the car must be put on Inspection, then back into Normal operation, or the RESET button must be pressed. Immediately check the starter and thermal overloads and all circuitry associated with the motor.</p>
<p><b>MPI SPA IS OFFLINE, MPI SPB IS OFFLINE, MPI SPC IS OFF LINE</b></p> <p><b>Description:</b> The indicated safety processor on the TC-MPI board is off line.</p> <p><b>Troubleshooting:</b></p> <ol style="list-style-type: none"> <li>1. Verify CAN connection to TC-MPI board.</li> <li>2. Reset processors (MPI board RSTA, RSTB, RSTC buttons). Verify ON LED lighted for all processors.</li> <li>3. If fault occurs while updating software, refer to update instructions and repeat process.</li> </ol>

**Table 5.1 Status and Error Messages**

Scrolling Message - Special Event Message
<b>MPI-A BRAKE MODULE 1 IS OFFLINE</b>
<p><b>Description:</b> Brake module 1 is not responding.</p> <p><b>Troubleshooting:</b></p> <ol style="list-style-type: none"> <li>1. Check the CAN connection to the module.</li> <li>2. Check power connections to the module.</li> <li>3. Replace the module.</li> </ol>
<b>MPI-A BRAKE MODULE 2 IS OFFLINE</b>
<p><b>Description:</b> Brake module 2 is not responding.</p> <p><b>Troubleshooting:</b></p> <ol style="list-style-type: none"> <li>1. Check the CAN connection to the module.</li> <li>2. Check power connections to the module.</li> <li>3. Replace the module.</li> </ol>
<b>MPI-A SPB IS OFFLINE</b>
<p><b>Description:</b> TC-MPI board safety processor SPB is offline.</p> <p><b>Troubleshooting:</b></p> <ol style="list-style-type: none"> <li>1. Power to the TC-MPI board may not be connected. Check the CAN bus connection between the TC-MPI board and the CAN hub.</li> <li>2. Make sure jumper JP1 on the TC-MPI board is not shorted.</li> <li>3. If the SPB indicator is not lighted, reboot the processor by cycling the power to the controller or by removing the CAN bus connection to the TC-MPI board for a few seconds.</li> </ol>
<b>MPI-A or B 2L BUS IS LOW</b>
<p><b>Description:</b> The 2L AC bus has fallen below the expected voltage.</p> <p><b>Troubleshooting:</b></p> <ol style="list-style-type: none"> <li>1. Check the 2L bus fuse.</li> <li>2. Check connection at PMT terminal X4.</li> </ol>
<b>MPI-A or B 2MV BUS MONITOR FAULT</b>
<p><b>Description:</b> The 2MV AC bus monitoring input on the CTL board is no longer detecting correct voltage.</p> <p><b>Troubleshooting:</b></p> <ol style="list-style-type: none"> <li>1. Check the 2MV bus fuse.</li> <li>2. Check connection at PMT terminal X4.</li> </ol>
<b>MPI-A or B ACTUAL AND REQUESTED DIRECTION MISMATCH</b>
<p><b>Description:</b> The processor has detected that the commanded run direction does not match the data reported by the positioning system. Power will be removed from brake and motor to bring the car to an immediate halt.</p> <p><b>Troubleshooting:</b></p> <ol style="list-style-type: none"> <li>1. Check CAN bus connections from landing positioning sensor to cartop box MC-LSI board.</li> <li>2. Check CAN bus connections from MC-LSI board to TC-MPI board in controller.</li> <li>3. Check 24V power to MC-LSI board in cartop box.</li> <li>4. Check condition and proper installation of encoded tape for positioning system.</li> <li>5. Check position sensor for excessive dirt or clogging.</li> </ol>

Table 5.1 Status and Error Messages

Scrolling Message - Special Event Message
<b>MPI-A or B CONTRACT OVERSPEED</b>
<p><b>Description:</b> The processor has detected a contract overspeed (F7 menu, parameter 145). Power will be removed from brake and motor to bring the car to an immediate halt. If changes have been made to LF.22, you must reset all three microprocessors on the TC-MPI board.</p> <p><b>Troubleshooting:</b></p> <ol style="list-style-type: none"> <li>1. Check the integrity of the landing/positioning system encoded tape.</li> <li>2. Use a hand tach to check the speed at which the overspeed is triggered.</li> </ol> <p>If this is occurring on a job that is just being set up or adjusted or has had this problem sporadically:</p> <ol style="list-style-type: none"> <li>3. Check F7 menu Contract Speed setting (parameter 149).</li> <li>4. Check F7 menu Contract Overspeed setting (parameter 145 should be set to about 108% of Contract Speed).</li> <li>5. Check F7 menu Hoist Motor Speed setting (parameter 148). Check correct gear ratio, KEB drive parameter LF.22.</li> <li>6. Check drive Contract Speed, High Speed, Sheave Diameter, Gear and Roping Ratio, Integral Gain, and Encoder settings.</li> </ol>
<b>MPI-A or B DET SW OVERSPEED</b>
<p><b>Description:</b> The processor has detected a Down Emergency Terminal overspeed. Power will be removed from brake and motor to bring the car to an immediate halt.</p> <p><b>Troubleshooting:</b></p> <ol style="list-style-type: none"> <li>1. Check the integrity of the landing/positioning system.</li> <li>2. If the job has a physical DET switch, check the switch and connections.</li> </ol> <p>If this is occurring on a job that is just being set up or adjusted or has had this problem sporadically:</p> <ol style="list-style-type: none"> <li>3. Check F7 menu U/DET Option setting (parameter 69).</li> <li>4. Check F7 menu DET Speed, Distance, Delta Distance, and Delta Speed settings (F7 parameters 104 through 107 respectively).</li> <li>5. Check F7 menu settings for the terminal slowdown switch immediately preceding the DET switch.</li> <li>6. Check Minimum Slowdown Distance (F5 drive LP.2). Must be less than: Shortest floor height minus (Level Distance + Maximum Stepping Distance + 6 inches). LP.2 is a displayed value, not directly adjustable but affected by F5 drive LF.20, LF.50, LF.51, LF.52, LF.53, LF.54, LF.55.</li> </ol>
<b>MPI A or B DET SW POSITION FAULT</b>
<p><b>Description:</b> The DET switch was not detected at the expected location. Power will be removed from brake and motor to bring the car to an immediate halt.</p> <p><b>Troubleshooting:</b></p> <ol style="list-style-type: none"> <li>1. Check the integrity of the landing/positioning system encoded tape.</li> <li>2. If a physical DET switch is used on this job, check switch wiring, integrity, and position.</li> </ol> <p>If this is occurring on a job that is just being set up or adjusted or has had this problem sporadically:</p> <ol style="list-style-type: none"> <li>3. Check F7 menu U/DET Option setting (parameter 69).</li> <li>4. Check F7 menu DET Distance and DET Delta Distance (parameters 105, 107 respectively).</li> </ol>
<b>MPI-A or B DNT SW HIGH OVERSPEED</b>
<p><b>Description:</b> The processor has detected a Down Normal Terminal Switch High overspeed (exceeding switch Speed setting plus Delta High Speed setting). Power will be removed from brake and motor to bring the car to an immediate halt. The car will then move at reduced speed to the next landing in the direction of travel. If the fault clears, the car will resume normal service. If not, the car will open its doors and remove itself from service.</p> <p><b>Troubleshooting:</b></p> <ol style="list-style-type: none"> <li>1. Check the integrity of the landing/positioning system encoded tape.</li> <li>2. If the job has a physical DNT switch, check the switch and connections.</li> <li>3. Check appropriate F5 menu overspeed parameters (17 - 40), to determine what car speed was at that switch for the last normal run and at the time of the overspeed.</li> <li>4. Check Minimum Slowdown Distance (F5 drive LP.2). Must be less than: Shortest floor height minus (Level Distance + Maximum Stepping Distance + 6 inches). LP.2 is a displayed value, not directly adjustable but affected by F5 drive LF.20, LF.50, LF.51, LF.52, LF.53, LF.54, LF.55.</li> </ol>

**Table 5.1 Status and Error Messages**

Scrolling Message - Special Event Message
<b>MPI-A or B DNT SW LOW OVERSPEED</b>
<p><b>Description:</b> The processor has detected a Down Normal Terminal Switch Low overspeed (exceeding switch Speed setting plus Delta Low speed setting). The car will perform an emergency slowdown, then move at reduced speed to the next landing in the direction of travel. If the fault clears, the car will resume normal service. If not, the car will open its doors and remove itself from service.</p> <p><b>Troubleshooting:</b></p> <ol style="list-style-type: none"> <li>1. Check the integrity of the landing/positioning system encoded tape.</li> <li>2. If the job has a physical DNT switch, check the switch and connections.</li> <li>3. Check appropriate F5 menu overspeed parameters (17 - 40), to determine what car speed was at that switch for the last normal run and at the time of the overspeed.</li> <li>4. Check Minimum Slowdown Distance (F5 drive LP.2). Must be less than: Shortest floor height minus (Level Distance + Maximum Stepping Distance + 6 inches). LP.2 is a displayed value, not directly adjustable but affected by F5 drive LF.20, LF.50, LF.51, LF.52, LF.53, LF.54, LF.55.</li> </ol>
<b>MPI A or B DNT SW POSITION ERROR</b>
<p><b>Description:</b> The DNT switch was not detected at the expected location. The car will perform an emergency slowdown and then move at reduced speed to the next landing in the direction of travel. If the fault clears, the car will resume normal service. If not, the car will open its doors and remove itself from service.</p> <p><b>Troubleshooting:</b></p> <ol style="list-style-type: none"> <li>1. Check the integrity of the landing/positioning system encoded tape.</li> <li>2. If a physical DNT switch is used on this job, check switch wiring, integrity, and position.</li> </ol> <p>If this is occurring on a job that is just being set up or adjusted or has had this problem sporadically:</p> <ol style="list-style-type: none"> <li>3. Check F7 menu U/DNT Option setting.</li> <li>4. Check F7 menu DNT Distance and DNT Delta Distance.</li> </ol>
<b>MPI A or B DOWN NORMAL LIMIT OPEN</b>
<p><b>Description:</b> The indicated processor has detected that the down directional limit switch is open. The car will run no further in the down direction.</p> <p><b>Troubleshooting:</b></p> <ol style="list-style-type: none"> <li>1. Review car adjustment and landing settings.</li> <li>2. Adjust as required to prevent the car from overshooting the terminal and activating the directional limit.</li> <li>3. If switch is physical, check voltage at terminal SPI3 on TC-MPI board and limit switch connections.</li> <li>4. If switch is virtual, check F7 programming.</li> </ol>
<b>MPI A or B DRIVE FAULT</b>
<p><b>Description:</b> The drive has faulted.</p> <p><b>Troubleshooting:</b></p> <ol style="list-style-type: none"> <li>1. Check the drive display to identify the fault. Proceed as described in the drive manual.</li> <li>2. After the problem has been corrected, reset the fault on the drive.</li> </ol>
<b>MPI A or B DRIVE NOT READY</b>
<p><b>Description:</b> The drive has not reported ready status, DRDY, to the controller.</p> <p><b>Troubleshooting:</b></p> <ol style="list-style-type: none"> <li>1. Check the drive display to identify any fault. Proceed as described in the drive manual.</li> <li>2. Check all connections from the controller to the drive and the drive to the motor.</li> <li>3. After the problem has been corrected, reset the fault on the drive.</li> </ol>
<b>MPI A or B DRIVE ON FAULT</b>
<p><b>Description:</b> The drive on input was lost while the car was in motion. This fault is reported immediately as opposed to the normal pre-run check Drive On fault which is rechecked after 15 seconds.</p> <p><b>Troubleshooting:</b></p> <ol style="list-style-type: none"> <li>1. The drive enable status is not identical on all the processors. Check the event log for discrepancies between the faults logged by each MPI processor.</li> </ol>

Table 5.1 Status and Error Messages

Scrolling Message - Special Event Message
<b>MPI A or B EBPS MONITOR FAULT</b>
<p><b>Description:</b> The EBPS, Emergency Brake Power Supply, (A and or B) input to the TC-MPI is in an opposite state from the RGR1_A/B, RGR2_A/B, and RGOK_A/B inputs.</p> <p><b>Troubleshooting:</b></p> <ol style="list-style-type: none"> <li>1. Check for 120 VAC on TC-MPI board terminal EBPS. If not present, check governor overspeed switch or fuse FEB (3 A type MDQ or 313 slow acting fuse).</li> <li>2. Check terminals RG1 and RG7 for 120VAC (power supply output).</li> <li>3. If no power at RG1 and RG7, check power supply</li> </ol>
<b>MPI A or B EEPROM FAULT</b>
<p><b>Description:</b> A device error has been detected during a cyclic redundancy check (code=1) or while reading from or writing to the device (code=2).</p> <p><b>Troubleshooting:</b></p> <ol style="list-style-type: none"> <li>1. Reset the microprocessor.</li> <li>2. Check that serial data links are properly connected and routed using shielded cable (through conduit where appropriate).</li> <li>3. Check for recently installed equipment that might be generating electrical noise.</li> <li>4. If the error occurred while updating firmware, re-attempt the update procedure.</li> </ol>
<b>MPI A or B EMERGENCY BRAKE CYCLE TEST FAULT</b>
<p><b>Description:</b> One of the EBP1/2/3/4 relays has failed the cycle test. If moving, the elevator will be taken out of service at the next landing. If in a landing zone, the elevator doors will open and the elevator will be taken out of service.</p> <p><b>Troubleshooting:</b></p> <ol style="list-style-type: none"> <li>1. Check that, when EBPS is high and 2MV is low that there is no voltage at terminal RG1, testpoint EBP12 or testpoint EBP34.</li> </ol>
<b>MPI A or B ETS SHUTDOWN FAULT</b>
<p><b>Description:</b> The named processor has detected that there is a difference in emergency terminal switch data (position or open/closed status) between itself and the other processor. If moving, the car will be stopped at the next landing, the doors opened for passenger exit, and the car taken out of service. If in a door zone, the car will remain at the landing, open doors for passenger exit, and be taken out of service.</p> <p><b>Troubleshooting:</b></p> <ol style="list-style-type: none"> <li>1. Check that emergency terminal switch F7 menu designations (virtual, physical, unused) and positions are correct.</li> <li>2. If switches are physical, check their actual positions and proper operation.</li> <li>3. Test elevator for proper operation.</li> </ol>
<b>MPI A or B EXCESSIVE FAULTS SHUTDOWN</b>
<p><b>Description:</b> The named processor has detected faults beyond an established limit in a circumscribed period of time.</p> <p><b>Troubleshooting:</b></p> <ol style="list-style-type: none"> <li>1. Check the connections to and from the TC-MPI board.</li> <li>2. Reset the microprocessor.</li> <li>3. Test elevator for proper operation.</li> </ol>
<b>MPI A or B GOVERNOR OVERSPEED</b>
<p><b>Description:</b> The named processor has detected the opening of the governor overspeed switch. The car will be brought to an immediate emergency stop.</p> <p><b>Troubleshooting:</b></p> <ol style="list-style-type: none"> <li>1. If the governor overspeed switch has not opened, check switch integrity and connections.</li> <li>2. If the car had in fact exceeded governor overspeed switch opening speed, troubleshoot to determine that cause of the overspeed.</li> </ol>

**Table 5.1 Status and Error Messages**

Scrolling Message - Special Event Message
<b>MPI A or B INCORRECT LANDING SYSTEM CHANNEL DETECTED</b>
<p><b>Description:</b> The named processor has detected that its associated CAN connection from the landing system is not reporting the correct channel identification. Usually, this means that the CAN 1 and CAN 2 connections from the hoistway position sensor to the TC-MPI board have been “swapped” at the TC-MPI board connector.</p> <p><b>Troubleshooting:</b></p> <ol style="list-style-type: none"> <li>1. Exchange the CAN 1 and CAN 2 connections on the TC-MPI board J17 connector.</li> </ol>
<b>MPI A or B INSPECTION OVERSPEED</b>
<p><b>Description:</b> The car has exceeded the Parameter 146 speed setting (F7 menu).</p> <p><b>Troubleshooting:</b></p> <ol style="list-style-type: none"> <li>1. Check physical motor related settings on drive.</li> <li>2. Verify inspection speed through the LCD screen (F3 Controller Utilities menu).</li> </ol>

Table 5.1 Status and Error Messages

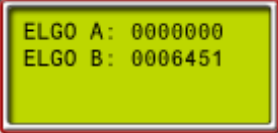
Scrolling Message - Special Event Message
<b>MPI A or B LANDING SYSTEM COMM LOSS</b>
<p><b>Description:</b> The TC-MPI board is not communicating with the landing system properly (A or B channel lost). Before beginning troubleshooting, check all related CAN connections and connectors carefully.</p> <p><b>Troubleshooting:</b></p> <ol style="list-style-type: none"> <li>On the controller processor board, place F3 in the UP position. Press "N" to access the system menu. Press "N" to advance to the Controller System Menu. Press "S" to select. The ELGO CAN channels will be displayed. If a channel has failed, the position information for that channel will be missing. For example:</li> </ol>

<p><b>Connections Through Traveler</b></p> <ol style="list-style-type: none"> <li>Check that the CAN connections at J17 on the TC-MPI board are clean and tight.</li> <li>On the cartop, temporarily disconnect the MACHINE ROOM / CANL2 and CANH2 wires from the MC-LSI board. Measure the resistance between them. It should read about 120-ohms (the termination value on the TC-MPI board). Repeat for the CANL1 and CANH1 wires. They should also read about 120-ohms.</li> </ol> <p>If a measured resistance other than about 120-ohms, you may have a damaged, broken, or shorted wire in the traveler. Resolve this issue before proceeding with additional troubleshooting.</p> <p><b>CHANNEL A</b></p> <ol style="list-style-type: none"> <li>If the lost channel is the A (CAN 2) channel, unplug all HC-CPI (control panel interface) and HC-UIO (universal I/O) board CAN connections from the TC-LSI (landing system interface board) on the cartop (CAN 2 is a shared bus). Recheck the display to see if both channels are now back on line.</li> <li>If the ELGO channels are now OK, reconnect the UIO boards one at a time. If the channel is lost, check the CAN terminations on the UIO board. If the board is terminated, open the termination by moving the jumper so the header pins are not shorted. Repeat for additional UIO boards, checking ELGO information as you go.</li> <li>Check the HC-CPI boards to see that only the last board in the string is terminated (CAN). Reconnect the CPI boards. Check ELGO information. If the A channel is lost again as you reconnect boards, contact MCE support for help in isolating the bad board or termination.</li> <li>If, after disconnecting the CPI and UIO boards, the A channel remained off line, temporarily connect CAN 1 connections to CAN 2 on the TC-MPI board. Place the processor F3 switch down and check the error code on the display:             <ul style="list-style-type: none"> <li>MPI-A INCORRECT LANDING SYSTEM CONNECTED - replace the ELGO reader head</li> <li>MPI-A LANDING SYSTEM COMM LOSS - continue numbered steps.</li> </ul> </li> <li>Temporarily connect CAN 2 connections to CAN 1 on the TC-MPI board. If the message changes to MPI-A INCORRECT LANDING SYSTEM CONNECTED, replace the ELGO reader head. If the message remains MPI-A LANDING SYSTEM COMM LOSS, replace the TC-MPI board.</li> </ol> <p><b>CHANNEL B</b></p> <ol style="list-style-type: none"> <li>If the lost channel is the B (CAN 1) channel, temporarily connect CAN 2 to CAN 1 on the TC-MPI board.</li> <li>If the display changes to MPI-B INCORRECT LANDING SYSTEM CONNECTED, replace the TC-MPI board.</li> <li>If the message remains MPI-B LANDING SYSTEM COMM LOSS, replace the ELGO reader head.</li> </ol>
<b>MPI A or B LANDING SYSTEM FAULT (EMERGENCY BRAKE DROPPED)</b>
<p><b>Description:</b> The emergency brake dropped due to a landing system fault while the door gate and door lock were open. The landing system fault is either (MPI-A/B) Relative Position High, Relative Position Low, or Landing System Comm Loss.</p> <p><b>Troubleshooting:</b></p> <ol style="list-style-type: none"> <li>Check the troubleshooting for the referenced faults.</li> </ol>

**Table 5.1 Status and Error Messages**

Scrolling Message - Special Event Message
<b>MPI A or B LEVELING OVERSPEED</b>
<p><b>Description:</b> MPI A or B on the TC-MPI board is reporting an overspeed during leveling.</p> <p><b>Troubleshooting:</b></p> <ol style="list-style-type: none"> <li>1. Use a hand-held tach to determine car speed during leveling.</li> <li>2. Check that the F7, Leveling Overspeed setting is correctly set (generally about 8% above drive LF.41, leveling speed).</li> <li>3. Check that the drive leveling speed, LF.41 is correctly set (about 16% of contract speed).</li> <li>4. Check that F7, Leveling Distance is correctly set (generally 4.0 inches).</li> <li>5. Check that drive LF.53 Decel Jerk, LF.54 Decel, and LF.55 Flare Jerk are properly set per your contract speed.</li> <li>6. The drive uses LF.50-51, LF.42 High Speed, and LF.20 Contract Speed settings to determine minimum slowdown distance, check that these are properly set.</li> </ol>
<b>MPI A or B PMDD CONTACTOR DROP MONITOR FAULT</b>
<p><b>Description:</b> MPI A or B on the TC-MPI board is reporting that the primary motor drop delay contactor did not drop out at the end of a run.</p> <p><b>Troubleshooting:</b></p> <ol style="list-style-type: none"> <li>1. PM delay drop relay K6 is stuck open.</li> <li>2. Verify that 2MV or 2L is not active.</li> <li>3. Verify that drive disable delay, F7 parameter 138, is less than 2 seconds.</li> <li>4. Verify the status of 2MV, 2L, and PMDD through MPI-C, F5 diagnostics. <a href="#">Please refer to "MPI-C Diagnostics" on page 4-82.</a></li> </ol>
<b>MPI A or B PMDD CONTACTOR PICK MONITOR FAULT</b>
<p><b>Description:</b> MPI A or B on the TC-MPI board is reporting that the primary motor drop delay contactor did not pick at the beginning of a run.</p> <p><b>Troubleshooting:</b></p> <ol style="list-style-type: none"> <li>1. PM delay drop relay K6 is stuck closed.</li> <li>2. Verify that 2MV and 2L have power. Doors must be closed and the SAFS relay must be picked for 2L to be active.</li> <li>3. Verify the status of 2MV, 2L, and PMDD through MPI-C, F5 diagnostics. <a href="#">Please refer to "MPI-C Diagnostics" on page 4-82.</a></li> </ol>
<b>MPI A or B RELATIVE POSITION HIGH</b>
<p><b>Description:</b> A or B channel from ELGO landing sensor (as specified in message) not being received.</p> <p><b>Troubleshooting:</b></p> <ol style="list-style-type: none"> <li>1. Check connections between sensor and cartop interface.</li> <li>2. If the rope gripper has dropped, hold EQ-RST on the TC-MPI board for six seconds, then press FAULT RESET on the HC-CTL board to reset.</li> </ol>
<b>MPI A or B RELATIVE POSITION LOW</b>
<p><b>Description:</b> A or B channel from ELGO landing sensor (as specified in message) not being received.</p> <p><b>Troubleshooting:</b></p> <ol style="list-style-type: none"> <li>1. Check connections between sensor and cartop interface.</li> <li>2. If the rope gripper has dropped, hold EQ-RST on the TC-MPI board for six seconds, then press FAULT RESET on the HC-CTL board to reset.</li> </ol>



Table 5.1 Status and Error Messages

Scrolling Message - Special Event Message
<p><b>MPI A or B RGOK DROPPED</b></p> <p><b>Description:</b> No voltage detected at terminal RG5 on the TC-MPI board. The OK indication from the rope gripper, which was previously present, has dropped while the car was in motion.</p> <p><b>Troubleshooting:</b></p> <ol style="list-style-type: none"> <li>1. Check emergency brake microswitch wiring.</li> <li>2. Cars without a rope brake should have a permanent jumper between RG5 and RG7.</li> <li>3. Make sure there is 120V at EBPS terminal of the TC-MPI board.</li> <li>4. One of the EBP1, EBP2, EBP3, or EBP4 relays may have failed open.</li> <li>5. Check that when EBPS is high and 2MV is high that there is 120V at terminal RG1.</li> <li>6. Reset the rope brake: Car on Inspection. Press fault reset on the HC-CTL board. Hold down the EB RESET button on the TC-MPI board for at least 8 seconds.</li> </ol>
<p><b>MPI A or B RGOK FAILED TO ACTIVATE</b></p> <p><b>Description:</b> No voltage detected at terminal RG5 on the TC-MPI board.</p> <p><b>Troubleshooting:</b></p> <ol style="list-style-type: none"> <li>1. Check emergency brake microswitch wiring.</li> <li>2. Cars without a rope brake should have a permanent jumper between RG5 and RG7.</li> <li>3. Make sure there is 120V at EBPS terminal of the TC-MPI board.</li> <li>4. One of the EBP1, EBP2, EBP3, or EBP4 relays may have failed open.</li> <li>5. Check that when EBPS is high and 2MV is high that there is 120V at terminal RG1.</li> <li>6. Reset the rope brake: Car on Inspection. Press fault reset on the HC-CTL board. Hold down the EB RESET button on the TC-MPI board for at least 8 seconds.</li> </ol>
<p><b>MPI A or B RGOK FAILED TO DEACTIVATE</b></p> <p><b>Description:</b> The processor is reporting that the RGOK monitor signal is active with the Emergency Brake disabled.</p> <p><b>Troubleshooting:</b></p> <ol style="list-style-type: none"> <li>1. Check that no wire is inserted into the RG5 terminal on the TC-MPI board. When the Emergency Brake option is set to DISABLED, the controller expects no voltage at the RG5 terminal.</li> </ol>
<p><b>MPI A or B SPC IS OFFLINE</b></p> <p><b>Description:</b> TC-MPI board safety processor MP is offline.</p> <p><b>Troubleshooting:</b></p> <ol style="list-style-type: none"> <li>1. Power to the TC-MPI board may not be connected. Check the CAN bus connection between the TC-MPI board and the CAN hub.</li> <li>2. Make sure jumper JP6 on the TC-MPI board is not shorted.</li> <li>3. If the MP indicator is not lighted, reboot the processor by cycling power to the controller or by removing the CAN bus connection to the TC-MPI board for a few seconds.</li> </ol>
<p><b>MPI A or B UET SW OVERSPEED</b></p> <p><b>Description:</b> The processor has detected an Up Emergency Terminal overspeed. Power will be removed from brake and motor to bring the car to an immediate halt.</p> <p><b>Troubleshooting:</b></p> <ol style="list-style-type: none"> <li>1. Check the integrity of the landing/positioning system encoded tape.</li> <li>2. If the job has a physical UET switch, check the switch and connections.</li> </ol> <p>If this is occurring on a job that is just being set up or adjusted or has had this problem sporadically:</p> <ol style="list-style-type: none"> <li>3. Check F7 menu U/DET Option setting (parameter 65).</li> <li>4. Check F7 menu UET Speed, Distance, Delta Distance, and Delta Speed settings.</li> <li>5. Check F7 menu settings for the terminal slowdown switch immediately preceding the UET switch. Check Minimum Slowdown Distance (F5 drive LP.2). Must be less than: Shortest floor height minus (Level Distance + Maximum Stepping Distance + 6 inches). LP.2 is a displayed value, not directly adjustable but affected by F5 drive LF.20, LF.50, LF.51, LF.52, LF.53, LF.54, LF.55.</li> </ol>

**Table 5.1 Status and Error Messages**

Scrolling Message - Special Event Message
<p><b>MPI A or B UET SW POSITION FAULT</b></p> <p><b>Description:</b> The UET switch was not detected at the expected location. Power will be removed from brake and motor to bring the car to an immediate halt.</p> <p><b>Troubleshooting:</b></p> <ol style="list-style-type: none"> <li>1. Check the integrity of the landing/positioning system encoded tape.</li> <li>2. If a physical UET switch is used on this job, check switch wiring, integrity, and position.</li> </ol> <p>If this is occurring on a job that is just being set up or adjusted or has had this problem sporadically:</p> <ol style="list-style-type: none"> <li>3. Check F7 menu U/DET Option setting (parameter 69). Check F7 menu UET Distance and UET Delta Distance.</li> </ol>
<p><b>MPI A or B UNINTENDED MOTION FAULT</b></p> <p><b>Description:</b> TC-MPI board has detected the car moving away from the door zone with both car gate and hoistway doors not fully closed and locked. Power will be removed from brake and motor, emergency rope gripper will engage.</p> <p><b>Troubleshooting:</b></p> <ol style="list-style-type: none"> <li>1. Put the car on Inspection.</li> <li>2. Press Fault Reset on the HC-CTL board.</li> <li>3. Hold down the EB RESET button on the TC-MPI board for at least 8 seconds to reset the rope brake.</li> </ol>
<p><b>MPI-A or B UNT SW HIGH OVERSPEED</b></p> <p><b>Description:</b> The processor has detected an Up Normal Terminal Switch High overspeed (exceeding switch Speed setting plus Delta High speed setting). Power will be removed from brake and motor to bring the car to an immediate halt. The car will then move at reduced speed to the next landing in the direction of travel. If the fault clears, the car will resume normal service. If not, the car will open its doors and remove itself from service.</p> <p><b>Troubleshooting:</b></p> <ol style="list-style-type: none"> <li>1. Check the integrity of the landing/positioning system encoded tape.</li> <li>2. If the job has a physical UNT switch, check the switch and connections.</li> <li>3. Check appropriate F5 menu overspeed parameters (17 - 40), to determine what car speed was at that switch for the last normal run and at the time of the overspeed.</li> <li>4. Check Minimum Slowdown Distance (F5 drive LP.2). Must be less than: Shortest floor height minus (Level Distance + Maximum Stepping Distance + 6 inches). LP.2 is a displayed value, not directly adjustable but affected by F5 drive LF.20, LF.50, LF.51, LF.52, LF.53, LF.54, LF.55.</li> </ol>
<p><b>MPI-A or B UNT SW LOW OVERSPEED</b></p> <p><b>Description:</b> The processor has detected an Up Normal Terminal Switch Low overspeed (exceeding switch speed setting plus Delta Low speed setting). The car will perform an emergency slowdown, then move at reduced speed to the next landing in the direction of travel. If the fault clears, the car will resume normal service. If not, the car will open its doors and remove itself from service.</p> <p><b>Troubleshooting:</b></p> <ol style="list-style-type: none"> <li>1. Check the integrity of the landing/positioning system encoded tape.</li> <li>2. If the job has a physical UNT switch, check the switch and connections.</li> <li>3. Check appropriate F5 menu overspeed parameters (17 - 40), to determine what car speed was at that switch for the last normal run and at the time of the overspeed.</li> <li>4. Check Minimum Slowdown Distance (F5 drive LP.2). Must be less than: Shortest floor height minus (Level Distance + Maximum Stepping Distance + 6 inches). LP.2 is a displayed value, not directly adjustable but affected by F5 drive LF.20, LF.50, LF.51, LF.52, LF.53, LF.54, LF.55.</li> </ol>

Table 5.1 Status and Error Messages

Scrolling Message - Special Event Message
<b>MPI A or B UNT SW POSITION ERROR</b>
<p><b>Description:</b> The UNT switch was not detected at the expected location. The car will perform an emergency slowdown and then move at reduced speed to the next landing in the direction of travel. If the fault clears, the car will resume normal service. If not, the car will open its doors and remove itself from service.</p> <p><b>Troubleshooting:</b></p> <ol style="list-style-type: none"> <li>1. Check the integrity of the landing/positioning system encoded tape.</li> <li>2. If a physical UNT switch is used on this job, check switch wiring, integrity, and position.</li> </ol> <p>If this is occurring on a job that is just being set up or adjusted or has had this problem sporadically:</p> <ol style="list-style-type: none"> <li>3. Check F7 menu U/DNT Option setting.</li> <li>4. Check F7 menu DNT Distance and DNT Delta Distance.</li> </ol>
<b>MPI A or B UP NORMAL LIMIT OPEN</b>
<p><b>Description:</b> The indicated processor has detected that the up directional limit switch is open. The car will run no further in the up direction.</p> <p><b>Troubleshooting:</b></p> <ol style="list-style-type: none"> <li>1. Review car adjustment and landing settings.</li> <li>2. Adjust as required to prevent the car from overshooting the terminal and activating the directional limit.</li> <li>3. If switch is physical, check voltage at terminal SPI4 on TC-MPI board and limit switch connections.</li> <li>4. If switch is virtual, check F7 programming.</li> </ol>
<b>MPI-B BRAKE MODULE 3 - 4 IS OFFLINE</b>
<p><b>Description:</b> The identified brake module is not responding.</p> <p><b>Troubleshooting:</b></p> <ol style="list-style-type: none"> <li>1. Check the CAN connection to the module.</li> <li>2. Check power connections to the module.</li> <li>3. Replace the module.</li> </ol>
<b>MPI-B SPA IS OFFLINE</b>
<p><b>Description:</b> TC-MPI board safety processor SPA is offline.</p> <p><b>Troubleshooting:</b></p> <ol style="list-style-type: none"> <li>1. Power to the TC-MPI board may not be connected. Check the CAN bus connection between the TC-MPI board and the CAN hub.</li> <li>2. Make sure jumper JP4 on the TC-MPI board is not shorted.</li> <li>3. If the SPA indicator is not lighted, reboot the processor by cycling power to the controller or by removing the CAN bus connection to the TC-MPI board for a few seconds.</li> </ol>
<b>MPI-C CONTRACT OVERSPEED</b>
<p><b>Description:</b> The machine has exceeded contract rotation (parameter 154 Contract Rotation).</p> <p><b>Troubleshooting:</b></p> <ol style="list-style-type: none"> <li>1. Check for correct gear ratio, drive parameter LF.22.</li> <li>2. If car is idle, check that the setting of F7 parameter 184 is correct.</li> </ol>
<b>MPI-C DRIVE FAULT</b>
<p><b>Description:</b> This fault indicates that the controller has detected a DFLT input The car will perform an emergency stop with the motor contactor and brake contactor immediately dropped.</p> <p><b>Troubleshooting:</b></p> <ol style="list-style-type: none"> <li>1. Check and troubleshoot drive faults.</li> </ol>
<b>MPI-C DRIVE NOT READY</b>
<p><b>Description:</b> The drive ready input failed to activate. Check the drive for a fault - troubleshoot the drive fault.</p> <p><b>Troubleshooting:</b></p> <ol style="list-style-type: none"> <li>1. Check the DRDY input to the TC-MPI board.</li> <li>2. Check the ready output from the drive.</li> <li>3. Check that the drive is operational.</li> </ol>

**Table 5.1 Status and Error Messages**

Scrolling Message - Special Event Message
<b>MPI-C DRIVE OFFLINE (STOP MODE)</b>
<p><b>Description:</b> The processor has detected that the drive is off line while the car is stopped.</p> <p><b>Troubleshooting:</b></p> <ol style="list-style-type: none"> <li>1. For KEB drive, verify that Lf.03 is set to "run."</li> </ol>
<b>MPI-C DRIVE ON FAILED TO ACTIVATE</b>
<p><b>Description:</b> The processor has reported that the drive on signal from the inverter drive was not present when checked.</p> <p><b>Troubleshooting:</b></p> <ol style="list-style-type: none"> <li>1. Check the signal connection from the drive to TC-MPI J16, P5.</li> <li>2. Check for error messages on the drive display.</li> <li>3. Check that the drive is properly configured and that all connections are as shown in the job prints.</li> <li>4. Check that the drive on output from the drive is in fact present (high).</li> </ol>
<b>MPI-C DRIVE ON FAILED TO DEACTIVATE</b>
<p><b>Description:</b> The processor has reported that the drive on signal from the inverter drive failed to drop when checked.</p> <p><b>Troubleshooting:</b></p> <ol style="list-style-type: none"> <li>1. Check the signal connection from the drive to TC-MPI J16, P5.</li> <li>2. Check for error messages on the drive display.</li> <li>3. Check that the drive is properly configured and that all connections are as shown in the job prints.</li> <li>4. Check that the drive on output from the drive is in fact present (high) when the elevator is stopped with no call demand.</li> <li>5. Replace the drive if the signal is incorrectly present.</li> </ol>
<b>MPI-C DRIVE ON LOST</b>
<p><b>Description:</b> The drive on input was lost while the car was in motion. This fault is reported immediately as opposed to the normal pre-run check Drive On fault which is rechecked after 15 seconds.</p> <p><b>Troubleshooting:</b></p> <ol style="list-style-type: none"> <li>1. Check the drive display to identify any drive faults which may have occurred.</li> </ol>
<b>MPI-C EEPROM CRC ERROR</b>
<p><b>Description:</b> The Cyclical Redundancy Checksum (CRC) stored on the TC-MPI board EEPROM does not match the computed CRC from the EEPROM.</p> <p><b>Troubleshooting:</b></p> <ol style="list-style-type: none"> <li>1. Cycle power. Reload and save parameters through the F7 menu.</li> </ol>
<b>MPI-C EEPROM DEVICE ERROR</b>
<p><b>Description:</b> The firmware is unable to communicate with the TC-MPI board EEPROM.</p> <p><b>Troubleshooting:</b></p> <ol style="list-style-type: none"> <li>1. Cycle power. Reload and save parameters through the F7 menu.</li> </ol>
<b>MPI-C EXCESSIVE FAULTS SHUTDOWN</b>
<p><b>Description:</b> The named processor has detected faults beyond an established limit in a circumscribed period of time.</p> <p><b>Troubleshooting:</b></p> <ol style="list-style-type: none"> <li>1. Check the connections to and from the TC-MPI board.</li> <li>2. Reset the microprocessor.</li> <li>1. Test elevator for proper operation.</li> </ol>

Table 5.1 Status and Error Messages

Scrolling Message - Special Event Message
<b>MPI-C FOLLOWING ERROR</b>
<p><b>Description:</b> Commanded speed and speed feedback from the motor encoder have deviated by more than the percentage of Following Error set through F7, parameter 189. The car performs an emergency stop, dropping power to the motor and the brake. After stopping, the car will again attempt to run. If the error persists, the car will be removed from service.</p> <p><b>Troubleshooting:</b></p> <ol style="list-style-type: none"> <li>1. Check the encoder cable and connection.</li> <li>2. Check to see what errors the drive is reporting.</li> <li>3. Run the car on Inspection. Check commanded speed and speed feedback through the MPI-C diagnostics screen. Please refer to "MPI-C Diagnostics" on page 4-82, addresses 16 and 18. For additional verification, use a hand tach to measure car speed. Adjust F7, 189 to 100% of contract speed to reduce sensitivity. If commanded speed and actual speed track, the problem is likely to be inadequate F7, 189 percentage or F7 and drive settings related to motor speed, gear reduction, sheave diameter, roping, etc. If commanded and actual speed deviate severely, the problem is likely to be with the encoder, encoder connection, or in the drive (which should be reporting errors as well).</li> </ol>
<b>MPI-C INSPECTION OVERSPEED</b>
<p><b>Description:</b> The car has exceeded the contract rotation calculated from 149 Contract Speed and 146 Inspection Overspeed parameters.</p> <p><b>Troubleshooting:</b></p> <ol style="list-style-type: none"> <li>1. Verify drive is set to SerSP.</li> <li>2. Adjust drive gear ratio parameter LF.22.</li> <li>3. Reset MPI board microprocessors.</li> <li>4. If car is idle, check that the setting of F7 parameter 184 is correct.</li> </ol>
<b>MPI-C LANDING SYS A POSITION DEVIATION</b>
<p><b>Description:</b> MPI-C on the TC-MPI board has detected that the position reported by the ELGO, A position sensor is not within limits when compared to the position synthesized feedback from the machine encoder. The car will perform an emergency stop and remove itself from service.</p> <p><b>Troubleshooting:</b></p> <ol style="list-style-type: none"> <li>1. Check appropriate F5 menu parameters (16 for microcontroller A/B and C) to determine if the speed feedback for microcontroller C is significantly different from microcontroller A/B. If it is, modify the hoist motor Speed parameter to change the speed seen by microcontroller C.</li> <li>2. Check the integrity of the position sensor head and tape. Check that the sensor head is clean.</li> <li>3. Check the CAN connection from the sensor head to the MC-LSI board.</li> <li>4. Replace the position system sensor head. Refer to the installation section of this manual and follow all installation steps and recommendations carefully.</li> </ol>
<b>MPI-C LANDING SYS B POSITION DEVIATION</b>
<p><b>Description:</b> MPI-C on the TC-MPI board has detected that the position reported by the ELGO, B position sensor is not within limits when compared to the position synthesized feedback from the machine encoder. The car will perform an emergency stop and remove itself from service.</p> <p><b>Troubleshooting:</b></p> <ol style="list-style-type: none"> <li>1. Check appropriate F5 menu parameters (16 for microcontroller A/B and C) to determine if the speed feedback for microcontroller C is significantly different from microcontroller A/B. If it is, modify the hoist motor Speed parameter to change the speed seen by microcontroller C.</li> <li>2. Check the integrity of the position sensor head and tape. Check that the sensor head is clean.</li> <li>3. Check the CAN connection from the sensor head to the MC-LSI board.</li> <li>4. Replace the position system sensor head. Refer to the installation section of this manual and follow all installation steps and recommendations carefully.</li> </ol>
<b>MPI-C LEVELING TIMER EXCEEDED</b>
<p><b>Description:</b> The car is traveling at leveling speed for an unusually long period of time. Direction will be dropped and a correction run will be performed to the next available landing.</p> <p><b>Troubleshooting:</b></p> <ol style="list-style-type: none"> <li>1. Verify eligibility is properly reflected in the F7 menu in regards to floor heights.</li> </ol>

**Table 5.1 Status and Error Messages**

Scrolling Message - Special Event Message
<b>MPI-C UNEXPECTED DIRECTION DROP</b>
<p><b>Description:</b> The up or down direction input has dropped while the car is running but is not in leveling operation.</p> <p><b>Troubleshooting:</b>                      Informational only.</p>
<b>MSAFL1 INPUT FAILURE</b>
<p><b>Description:</b> The MSAFL1 input monitors SAFL and SAFS relay contacts against the circuits that drive the relay coils. Bus 2L should be 120VAC and relay SAFL should be picked only if the doors are locked.</p> <p><b>Troubleshooting:</b></p> <ol style="list-style-type: none"> <li>1. Check or replace relays SAFL and/or SAFS on the HC-CTL board.</li> <li>2. Check that IDC terminal 2L on the HC-CTL board connects to IDC terminal 2L on the TC-MPI board.</li> </ol>
<b>MSAFS1 INPUT FAILURE</b>
<p><b>Description:</b> The MSAFS1 input monitors SAFL and SAFS relay contacts against the circuits that drive the relay coils. Relay SAFS should be picked only if the safety string is made.</p> <p><b>Troubleshooting:</b></p> <ol style="list-style-type: none"> <li>1. Check or replace relays SAFL and/or SAFS on the HC-CTL board.</li> <li>2. Check wiring associated with screw terminals SAFH, SAFC and ESC.</li> </ol>
<b>MSSD FAILED ACTIVE</b> (Hydraulic Elevators Only)
<p><b>Description:</b> MSSD monitors the solid state output of U1 and driver TY for proper operation. If either fail in the on position, this fault is generated.</p> <p><b>Troubleshooting:</b></p> <ol style="list-style-type: none"> <li>1. Check terminal SSD wiring.</li> </ol>
<b>MTAB INPUT FAILURE</b>
<p><b>Description:</b> The Top Access Bypass Monitor (MTAB) input has detected a failure of the Top Access Bypass (TAB) or (TABA) outputs.</p> <p><b>Troubleshooting:</b></p> <ol style="list-style-type: none"> <li>1. Verify wiring at HC-CTL board terminals TAB and DLAT.</li> <li>2. Check access switches and proper wiring of access terminals ATU, ATD.</li> </ol>
<b>MTABR INPUT FAILURE</b>
<p><b>Description:</b> The Top Rear Access Monitor (MTABR) input has detected a failure of the Top Rear Access Bypass (TABR) or (TABAR) outputs or the TABR input.</p> <p><b>Troubleshooting:</b></p> <ol style="list-style-type: none"> <li>1. Verify wiring at HC-RDR board terminals TABR and DLATR.</li> <li>2. Check access switches and proper wiring of access terminals ATU, ATD.</li> </ol>
<b>MTBR INPUT FAILED TO ACTIVATE</b>
<p><b>Description:</b> The voltage monitored at the TC-MPI board BR triac did not go high when the triac was deactivated.</p> <p><b>Troubleshooting:</b></p> <ol style="list-style-type: none"> <li>1. Check the BR test point. There should be 120V here when the triac is not attempting to pick contactor BR.</li> <li>2. Check BR, PM auxiliary contactors, and 2L screw terminal connections and wiring.</li> </ol>
<b>MTBR INPUT FAILED TO DEACTIVATE</b>
<p><b>Description:</b> The voltage monitored at the TC-MPI board BR triac did not go low when the triac was activated.</p> <p><b>Troubleshooting:</b></p> <ol style="list-style-type: none"> <li>1. Check the BR test point. There should be 0V here when the triac is attempting to pick contactor BR.</li> <li>2. Check BR, PM auxiliary contactors, and 2L screw terminal connections and wiring.</li> </ol>

Table 5.1 Status and Error Messages

Scrolling Message - Special Event Message
<b>MTPM INPUT FAILED TO ACTIVATE</b>
<p><b>Description:</b> The voltage monitored at the TC-MPI board PM triac did not go low when the triac was activated.</p> <p><b>Troubleshooting:</b></p> <ol style="list-style-type: none"> <li>1. Check the PM test point. There should be 0V here when the triac is attempting to pick the contactor PM.</li> <li>2. Check PM, PM2 and 2MV screw terminal connections and wiring.</li> </ol>
<b>MTPM INPUT FAILED TO DEACTIVATE</b>
<p><b>Description:</b> The voltage monitored at the TC-MPI board PM triac did not go high when the triac was deactivated.</p> <p><b>Troubleshooting:</b></p> <ol style="list-style-type: none"> <li>1. Check the PM test point. There should be 120V here when the triac is not attempting to pick the contactor PM.</li> <li>2. Check PM, PM2 and 2MV screw terminal connections and wiring.</li> </ol>
<b>MUSE INPUT IS LOW</b>
<p><b>Description:</b> This is a hydraulic controller error message. On the Motion 4000, it indicates that the F1 menu, CONTROLLER TYPE, has been unintentionally set to M2000. To correct, set CONTROLLER TYPE to M4000 and save parameters.</p>
<b>NORMAL OPERATION</b>
<p><b>Description:</b> The elevator is on "automatic" or Normal passenger operation.</p>
<b>NORMAL (PIT FLOOD) OPERATION</b>
<p><b>Description:</b> The elevator is on "automatic" or Normal passenger operation with the pit flood input active. In this mode, the car will not serve floors beneath the flood level set. <a href="#">Please refer to "FLR COUNT BELOW FLOOD LEVEL?" on page 4-47.</a></p> <p><b>Troubleshooting:</b></p> <ol style="list-style-type: none"> <li>1. If pit flood operation is in error, refer to the drawings for the job and verify the PTFLD input is correctly configured (connected/disconnected/connected in error).</li> </ol>
<b>OVERLOAD CONDITION</b>
<p><b>Description:</b> The car appears to be overloaded, as indicated by the load weigher input OVL.</p> <p><b>Troubleshooting:</b> Check the OVL input. If power is present on the OVL input, the load weigher contact associated with this input is closed. This contact being closed indicates the car is overloaded.</p>
<b>PASSCODE REQUEST</b>
<p><b>Description:</b> The Passcode Request Option is active (System Mode Menu).</p> <p><b>Troubleshooting:</b> System can be run on Inspection only. Passcode must be entered correctly in System Mode Menu to deactivate this option and allow the controller to run normally. See <a href="#">4-56</a>.</p>
<b>POWER TRANSFER INPUT ACTIVE</b>
<p><b>Description:</b> The PTI input has been activated.</p> <p><b>Troubleshooting:</b> In Program Mode, see if a PTI input is programmed and if it is active.</p>
<b>PMP INPUT FAILED TO ACTIVATE</b>
<p><b>Description:</b> Normally closed Auxiliary contactor for PM contact did not drop out at end of run.</p> <p><b>Troubleshooting:</b></p> <ol style="list-style-type: none"> <li>1. Check PMP testpoint for 120V on TC-MPI board. When PM contactor is dropped, PMP should go high.</li> </ol>
<b>PMP INPUT FAILED TO DEACTIVATE</b>
<p><b>Description:</b> Normally open Auxiliary contactor for PM contact did not pick at end of run.</p> <p><b>Troubleshooting:</b></p> <ol style="list-style-type: none"> <li>1. Check PMP testpoint for 120V on TC-MPI board. When PM contactor is dropped, PMP should go low.</li> </ol>

**Table 5.1 Status and Error Messages**

Scrolling Message - Special Event Message
<b>POWER TRANSFER INPUT ACTIVE</b>
<p><b>Description:</b> The car is stopped while power is transferred from commercial to backup or vice versa.  <b>Troubleshooting:</b>                      Informational.</p>
<b>R2L INPUT FAILURE (CTLA)</b>
<p><b>Description:</b> R2L monitors the state of the 2L relay. The R2L input must be low when the 2L bus is active and high when the 2L bus is low.  <b>Troubleshooting:</b>                      Check the circuitry associated with the 2L relay.</p>
<b>RDR SPA IS OFFLINE</b>
<p><b>Description:</b> HC-RDR board processor A is offline.  <b>Troubleshooting:</b></p> <ol style="list-style-type: none"> <li>1. Power to the HC-RDR board may not be connected. Check the CAN bus connection between the HC-RDR board and the HC-CHP CAN hub and board.</li> <li>2. Make sure jumper JP3 on the HC-RDR board is not shorted.</li> <li>3. If the SPA indicator is not lighted, reboot the processor by cycling power to the controller or by removing the CAN bus connection to the HC-RDR board for a few seconds.</li> </ol>
<b>RDR SPB IS OFFLINE</b>
<p><b>Description:</b> HC-RDR board safety processor B is offline.  <b>Troubleshooting:</b></p> <ol style="list-style-type: none"> <li>1. Power to the HC-RDR board may not be connected. Check the CAN bus connection between the HC-RDR board and the HC-CHP CAN hub and board.</li> <li>2. Make sure jumper JP4 on the HC-RDR board is not shorted.</li> <li>3. If the SPB indicator is not lighted, reboot the processor by cycling power to the controller or by removing the CAN bus connection to the HC-RDR board for a few seconds.</li> </ol>
<b>REAR CAR DOOR BYPASS SW. FAILURE</b>
<p><b>Description:</b> Indicates that the REAR CAR DOOR BYPASS switch has failed.  <b>Troubleshooting:</b></p> <ol style="list-style-type: none"> <li>1. Cycle the HC-RDR board car door bypass switch a few times to exercise it. Verify that it is fully in the ON or OFF position.</li> <li>2. Verify 2S and GSR connections and wiring.</li> </ol>
<b>REAR DOL &amp; DLK ARE BOTH ACTIVE</b>
<p><b>Description:</b> The Door Open Limit Rear and Door Lock inputs are both active, DOLR=0 and DLK=1. There is a problem with DOLR and/or DLK circuitry or wiring.  <b>Troubleshooting:</b> Inspect the Door Open Limit Rear and the Door Lock circuitry and wiring. When this error is generated, the car will shut down with the doors open and will not answer any calls. To reset this error condition, put the car on Inspection operation.</p>
<b>REAR DOOR FAILED TO CLOSE</b>
<p><b>Description:</b> Doors Open (DCLR = 1). There is a problem with DCLR circuitry or wiring.  <b>Troubleshooting:</b> Inspect the Door Closed Limit Rear circuitry and wiring. When this error is generated, the car is not allowed to run.</p>
<b>REAR DOOR IS LOCKED BUT NOT FULLY CLOSED</b>
<p><b>Description:</b> Rear Doors Open (DCLR = 1) and Locked (DLK = 1). Indicates a problem with DCLR and/or DLK circuitry or wiring.  <b>Troubleshooting:</b> Inspect the Door Closed Limit Rear and the Door Lock circuitry and wiring. When this error is generated, the car is not allowed to run.</p>



Table 5.1 Status and Error Messages

Scrolling Message - Special Event Message
<b>REAR DOOR LOCK SWITCH FAILURE</b>
<b>Description:</b> The rear door lock contacts have failed closed. <b>Troubleshooting:</b> Ensure that, with the rear hoistway doors closed and locked, there is power on the DLSR input and no power on the DCLR input.
<b>REAR DOOR OPEN LIMIT FAILURE</b>
<b>Description:</b> The rear door open limit switch has failed open. <b>Troubleshooting:</b> Ensure that the rear car gate is open, there is no power on the DOLR input, and no power is present on the DLSR or CDR inputs.
<b>REAR DZ RELAY DISCREPANCY</b>
<b>Description:</b> Traction elevator only. HC-CTL door zone input and door zone flag from TC-MPI board do not match. The elevator will stop at the next floor in the direction of travel and shut down until the fault is cleared (HC-CTL fault reset or toggle Inspection switch). <b>Troubleshooting:</b> <ol style="list-style-type: none"> <li>1. Verify door zone (virtual if ELGO system, magnet if LS-EDGE) input. Reset A, B, and C processors on TC-MPI board.</li> <li>2. Verify connection between MPI board DZRO and RDR board DZR.</li> </ol>
<b>REAR GATE SWITCH FAILURE</b>
<b>Description:</b> The rear car gate switch has failed closed. <b>Troubleshooting:</b> Ensure that, with the rear car gate closed, there is power on the GSR input and no power on the DCLR input.
<b>REAR HOISTWAY DOOR BYPASS SW. FAILURE</b>
<b>Description:</b> Indicates that the REAR HOISTWAY DOOR BYPASS switch has failed. <b>Troubleshooting:</b> <ol style="list-style-type: none"> <li>1. Cycle the HC-RDR board hoistway door bypass switch a few times to exercise it. Verify that it is fully in the ON or OFF position.</li> <li>2. Verify 2S and DLABR connections and wiring.</li> </ol>
<b>RESTORING SAFETY</b>
<b>Description:</b> This message will be displayed while the system checks the safety integrity of the controller when coming out of car top inspection.
<b>SABBATH OPERATION ACTIVE</b>
<b>Description:</b> The spare input SAB has been activated. <b>Troubleshooting:</b> Check spare input bit address for SAB. Verify that the spare input address matches the actual input connection. Check voltage level at the SAB input.
<b>SAFC INPUT FAILURE</b>
<b>Description:</b> The controller has detected that the Car Safety String (SAFC) input on the HC-CTL board is in an incorrect state. It should not have 120VAC unless the SAFH input also has 120VAC. <b>Troubleshooting:</b> Check the wiring or devices connected to the SAFC input. This could also be caused by a component failure on the HC-CTL board.
<b>SAFETY CIRCUIT IS OPEN</b>
<b>Description:</b> The Car Operating Panel emergency stop switch has been pulled or another contact switch in the safety circuit is open. <b>Troubleshooting:</b> Check the C.O.P. stop switch. Check the other switches and contacts in the safety string. Check safety string wiring against the MCE wiring diagrams.
<b>SAFETY DROPPED BY SPB</b>
<b>Description:</b> Safety processor B on the HC-CTL board has dropped the safety relay. <b>Troubleshooting:</b> <ol style="list-style-type: none"> <li>1. Cycle power.</li> <li>2. Check the event log to see what events led up to the occurrence.</li> </ol>

**Table 5.1 Status and Error Messages**

Scrolling Message - Special Event Message
<p><b>SPA IS OFFLINE</b></p> <p><b>Description:</b> HC-CTL board safety processor A is offline.  <b>Troubleshooting:</b></p> <ol style="list-style-type: none"> <li>1. HC-CTL board power may not be connected. Check the CAN bus connection between the HC-CTL board and the HC-CHP CAN board.</li> <li>2. Make sure jumper JP3 on the HC-CTL board is not shorted.</li> <li>3. If the SPA indicator is not lighted, reboot the processor by cycling power to the controller or by removing the CAN bus connection to the HC-CTL board for a few seconds.</li> <li>4. If fault occurs while updating software, refer to update instructions and repeat process.</li> </ol>
<p><b>SPB IS OFFLINE</b></p> <p><b>Description:</b> HC-CTL board safety processor B is offline.  <b>Troubleshooting:</b></p> <ol style="list-style-type: none"> <li>1. Power to the HC-CTL board may not be connected. Check the CAN bus connection between the HC-CTL board and the HC-CHP CAN hub and board.</li> <li>2. Make sure jumper JP4 on the HC-CTL board is not shorted.</li> <li>3. If the SPB indicator is not lighted, reboot the processor by cycling power to the controller or by removing the CAN bus connection to the HC-CTL board for a few seconds.</li> <li>4. If fault occurs while updating software, refer to update instructions and repeat process.</li> </ol>
<p><b>SPC IS OFFLINE</b></p> <p><b>Description:</b> HC-CTL board safety processor C is offline.  <b>Troubleshooting:</b></p> <ol style="list-style-type: none"> <li>1. Power to the HC-CTL board may not be connected. Check the CAN bus connection between the HC-CTL board and the HC-CHP CAN hub and board.</li> <li>2. Make sure jumper JP6 on the HC-CTL board is not shorted.</li> <li>3. If the SPC indicator is not lighted, reboot the processor by cycling power to the controller or by removing the CAN bus connection to the HC-CTL board for a few seconds.</li> <li>4. If fault occurs while updating software, refer to update instructions and repeat process.</li> </ol>
<p><b>TIME OUT OF SERVICE</b></p> <p><b>Description:</b> The T.O.S. timer has expired.  <b>Troubleshooting:</b> The elevator has been delayed, usually by a door being obstructed. The Time Out of Service timer has expired and the elevator has been taken out of service.</p>
<p><b>TOP ACCESS SW. FAILURE</b></p> <p><b>Description:</b> The Up and Down Top Access switch inputs are active at the same time.  <b>Troubleshooting:</b> Check the wiring and the switch associated with the ATU and ATD inputs.</p>
<p><b>UP AND DOWN TERMINAL SPEED REDUCING LIMITS OPEN</b></p> <p><b>Description:</b> Floors have not been learned.  <b>Troubleshooting:</b> Check parameters for UNTS1 and DNTS1. Make sure that D/UNTS1 option is set to VIRTUAL. If no Elgo tape has been hung, put the car on Inspection Bypass Mode (F3 menu) to stop this fault.</p>

## Duplexing

Duplexing allows one car controller to assign hall calls to itself and one other car. Duplexing requires a connecting cable and selecting the Duplex option (see “F1: Program Mode” on page 4-11). Duplexing improves hall call assignment, increases efficiency, and decreases wait times.

### Dispatching Algorithm

The dispatching algorithm for assigning hall calls is real-time, based on estimated time of arrival (ETA). In calculating the estimated time of arrival for each elevator, the dispatcher will consider, but not be limited to, the location of each elevator, direction of travel, existing hall and car call demand, door time, flight time, lobby removal time penalty, and coincidence call.

### Hardware Connections

There are three critical points in duplexing hardware:

- Proper grounding between the two controller subplates
- Proper installation of the duplexing cable
- Jumper JP3 on each HC-MPU board must be in position

Hall calls will be connected to both cars simultaneously. Once in duplex configuration, either of the two controllers can become the dispatcher of hall calls. The controller that assumes the dispatching duty on power up remains the dispatching processor until it is taken out of service. If, for any reason, the communication link between the two controllers does not function, each car will respond to the registered hall calls independently.

In a duplexing configuration, the controller that assumes dispatching duty is identified by the letter D in the upper left corner of the LCD. The other car is identified by the letter S, in the upper left corner of the LCD. If the upper left-hand corner of the LCD is blank (neither D nor S displayed), the cars are not communicating, and troubleshooting will be required to determine the cause.

## PC Board Quick References

This section contains component photographs with call outs, input/outputs, indicators, jumpers, test points and other information.

**Table 5.2 Motion 4000 Circuit Boards**

Board	Name	See
HC-CHP	CAN Hub and Power Supply Board	5-39
HC-CTL	Control Board	5-41
HC-MPU	Main Processor Unit Board	5-50
HC-RDR	Rear Door Board	5-53
HC-UIO	Universal Input/Output Board	5-57
MC-CPI	Car Panel Interface Board	5-61
MC-LSI	Landing System Interface Board	5-66
SC-3HN	Three Input Serial Hall Call Node Board	5-67
TC-MPI	Motion Processor Interface	5-71

**Figure 5.1 Motion 4000 PC Boards**

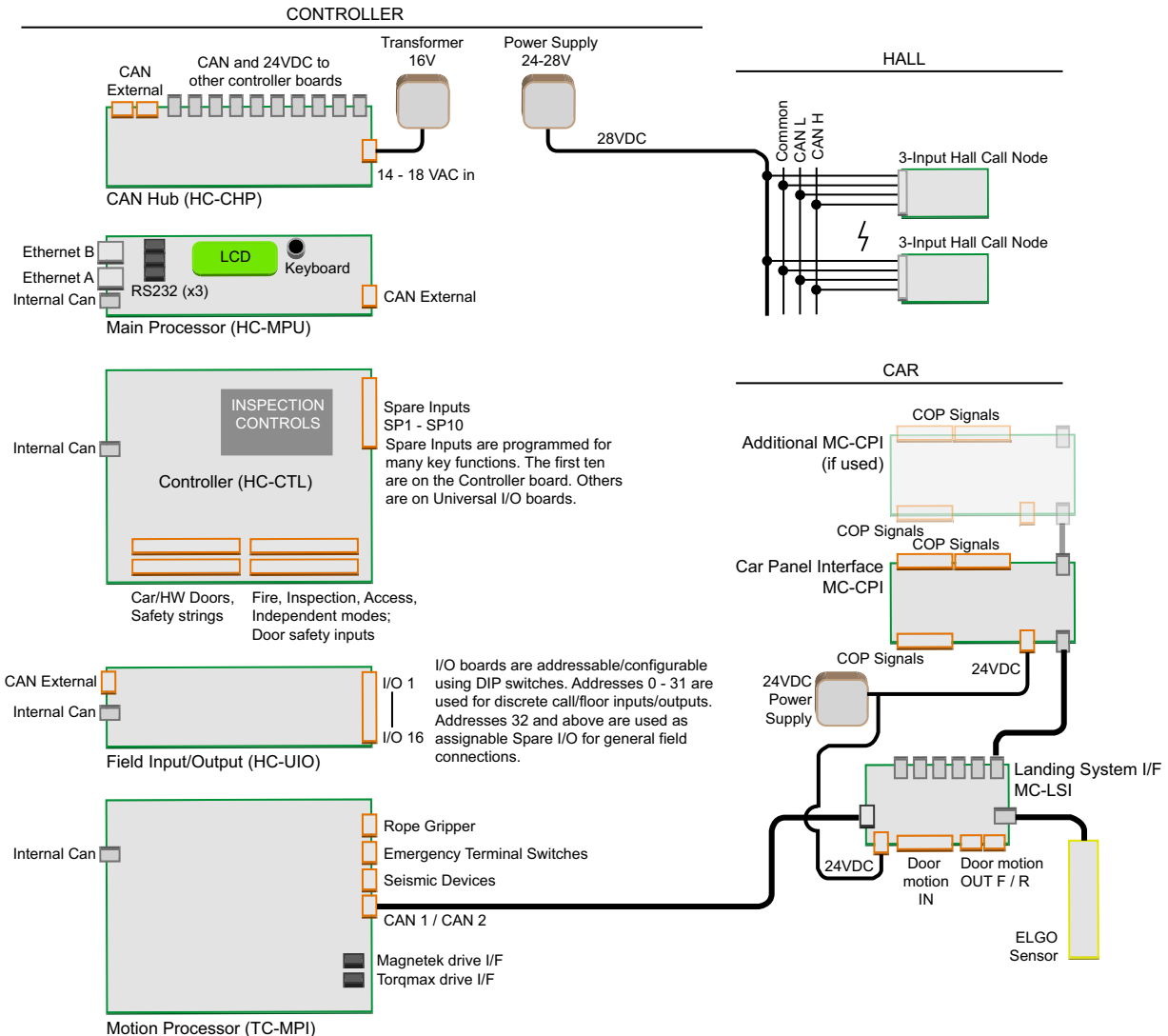

## HC-CHP CAN Hub and Power Supply Board

This board provides 4-amp power for boards throughout the controller and a central connection point for the Controller Area Network (CAN).

Figure 5.2 HC-CHP CAN Hub and Power Supply Board

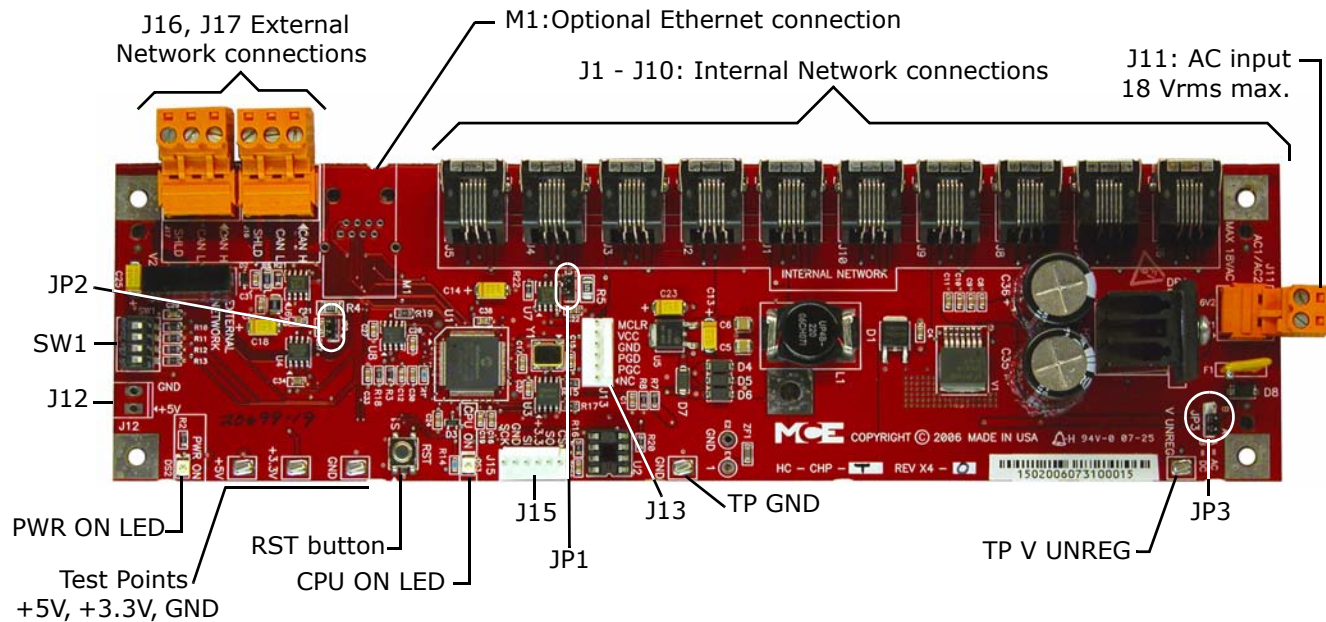

### Connectors

- J1 - J10: Network connections to boards inside the controller cabinet.
- J11: Low voltage AC input - 16V1/16V2, maximum 18Vrms.
- J12: Optional +5Vdc output.
- J13: Serial programming port for microcontroller.
- J15: Interface to external memory.
- J16, J17: External CAN network connections to boards or equipment outside the cabinet.
- M1: Optional Ethernet connection.

### Jumpers

- JP1: Internal CAN bus termination resistor.
- JP2: External CAN bus termination resistor.
- JP3: Sets pick-off point for power failure detection. Factory use only. Default is A= Direct AC monitoring.

### Test Points

- +5V: +5Vdc measured between this test point and TP GND.
- +3.5V: +3.3Vdc measured between this test point and TP GND.
- GND: 0V.
- V UNREG: 24V  $\pm$  20% measured between this test point and TP GND.

**Indicators**

- PWR ON: +5V indicator.
- CPU ON: LED on indicates that the on-board microcontroller is functional.

**Switches**

- SW1: DIP switch used to set board initialization behavior.
- RST: Microcontroller reset button.

**Figure 5.3 Upgrading Motion 4000 Firmware**

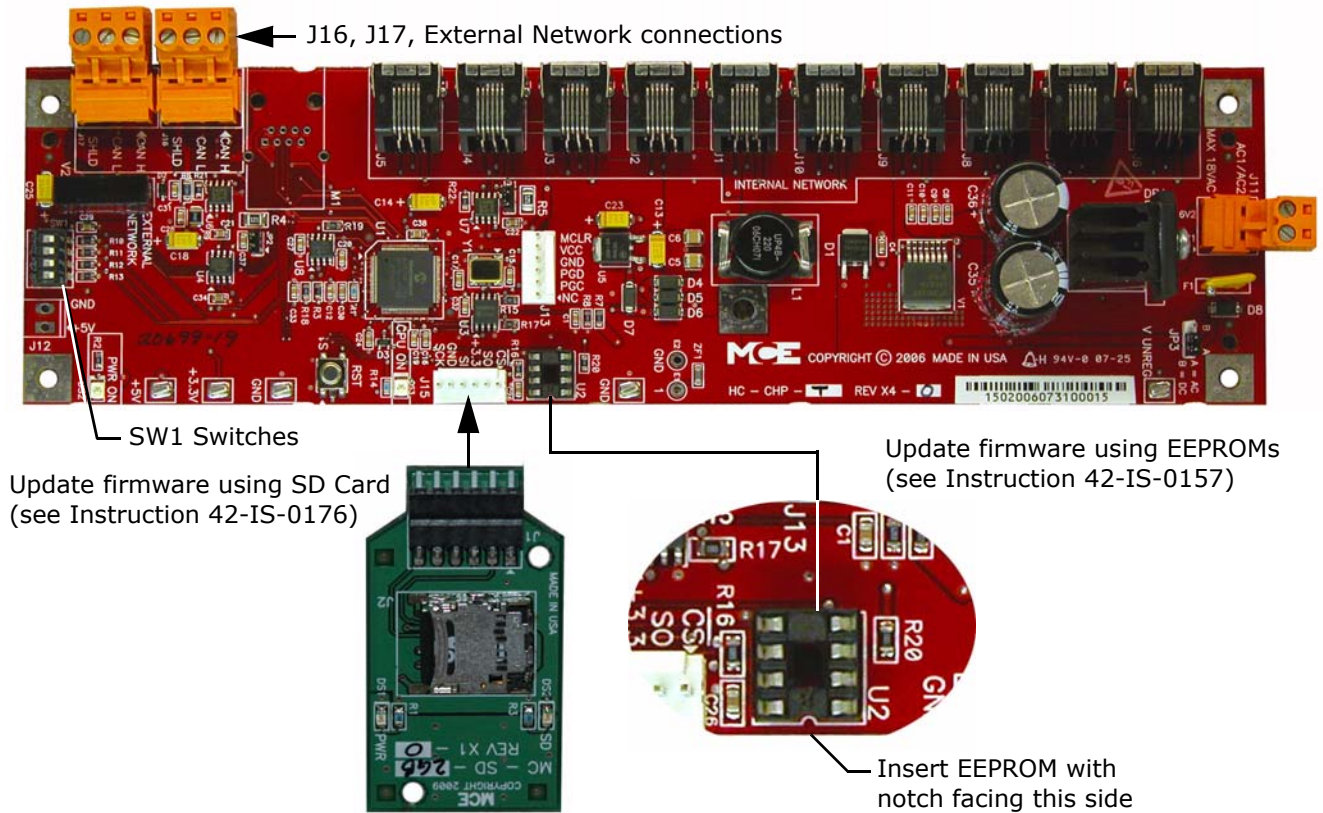

**SW1 DIP Switch Settings**



SW1 DIP Switch Settings			
DIP 1	DIP 2	DIP 3	Description
Off	Off	Off	Normal boot up (bypasses firmware update)
On	On	On	Updates firmware different from EEPROM or SD card
On	On	Off	Forced update (fixes corrupted software)
On = switch left, Off = switch right			

**DIP 4** Sets the communication baud rate for the External CAN bus (Off = 125 kbs, On = 250 kbs).  
**DO NOT** change this switch setting.

### HC-CTL Control Board

The HC-CTL Control board monitors I/O, performs safety functions and front door operation. The HC-CTL board is responsible for Inspection, Fire Service, Landing System, door lock bypass and lanterns and gongs.

Figure 5.4 HC-CTL Control Board

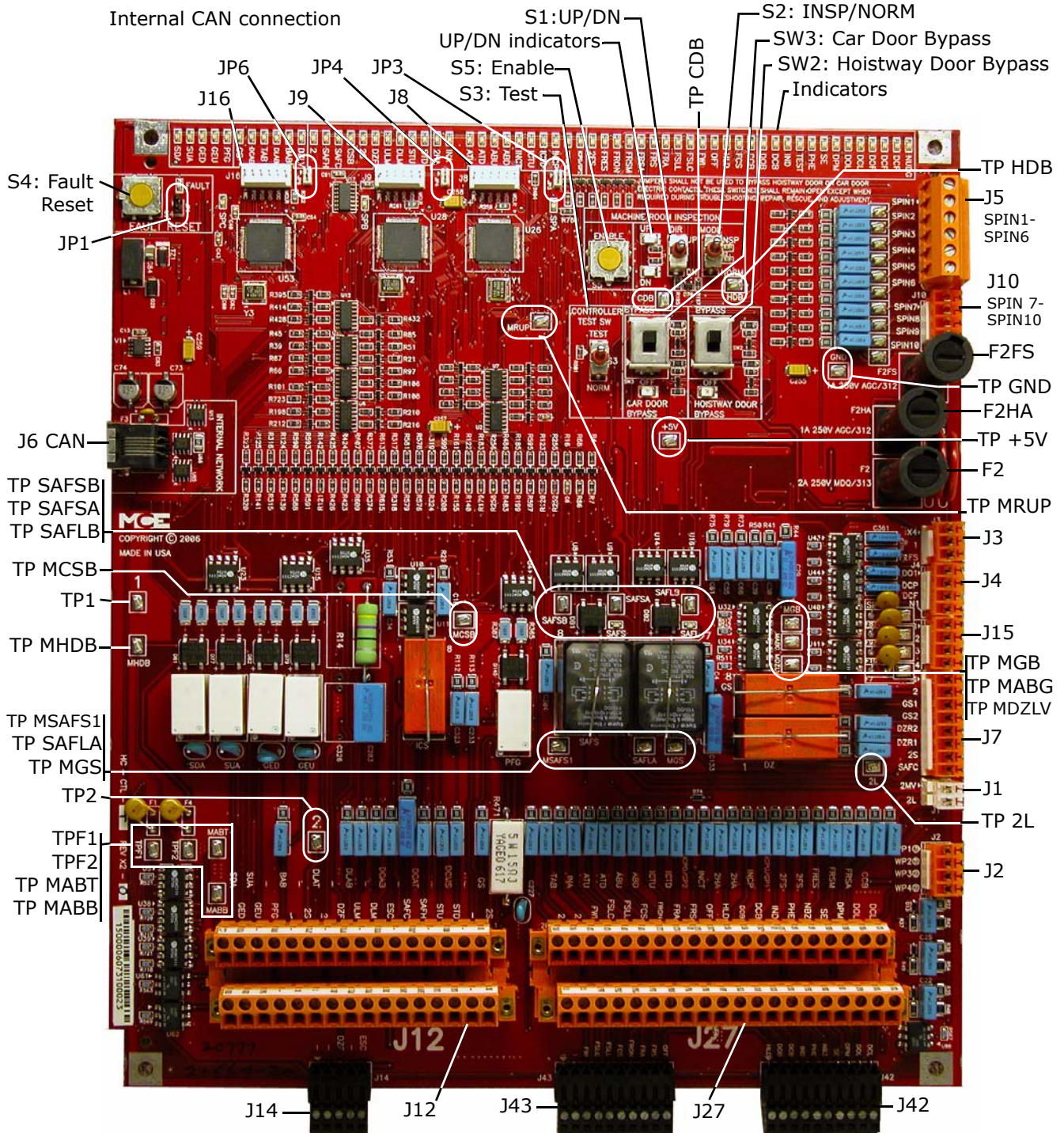

**Table 5.3 HC-CTL Board Terminals**

Connector	Terminal	Description
J1	2MV	Provides 120VAC to 2L bus when SAFL and SAFS relays are picked (input).
	2L	Provides 120VAC to valves and motor signals when doors are locked and safety string is made up (Output).
J2	WP1	not currently used
	WP2	not currently used
	WP3	not currently used
	WP4	not currently used
J3	X4	120VAC from power transformer (input)
	1	1 bus (ground)
	F2FS	Provides 120VAC to fire service sensors and signals
J4	DO1	Door open function (Output that signals the controller to attempt to open the doors)
	DCP	Door close power
	DCF	Door close function (Output that signals the controller to attempt to close the doors)
	N1	Nudging (Output that signals the controller to attempt to close the doors at reduced torque)
J5	SPIN1	Programmable spare input #1
	SPIN2	Programmable spare input #2
	SPIN3	Programmable spare input #3
	SPIN4	Programmable spare input #4
	SPIN5	Programmable spare input #5
	SPIN6	Programmable spare input #6
J6		Internal CAN connection
J7	1	1 bus (Ground)
	2	2 bus (120 VAC)
	GS1	Rear door lock string input (Controllers without rear doors should have a jumper between GS1 and GS2) (used for board interconnections)
	GS2	Rear door lock string output (used for board interconnections)
	DZR2	Rear Door zone (Output) (used for board interconnections)
	DZR1	Rear Door zone (Input) (used for board interconnections)
	2S	Provides 120VAC to the gate switch, inspection access switch, and door locks
	SAFC	When this signal is low, in-car stop is activated. ESC terminal provides 120VAC to this signal during fire recall (In car stop switch bypass)
J8		Used to program the U26 microcontroller
J9		Used to program the U28 microcontroller
J10	SPIN7	Programmable spare input #7
	SPIN8	Programmable spare input #8
	SPIN9	Programmable spare input #9
	SPIN10	Programmable spare input #10



**Table 5.3 HC-CTL Board Terminals**

Connector	Terminal	Description
J12 (1-16) upper connector	GS	Gate Switch (input)
	-	No connection
	DCMS	Door Contact Middle String (input)
	-	No connection
	DCAT	Door Contact Access Top (input)
	-	No connection
	DCAB	Door Contact Access Bottom (input)
	-	No connection
	DLAB	Bottom Door Lock (input)
	-	No connection
	DLAT	Top Door Lock (input)
	-	No connection
	BAB	Bottom Access 2nd Pole
	-	No connection
	SUA	Up Direction Arrow (output)
SDA	Down Direction Arrow (output)	
J12 (17-32) lower connector	2S	120VAC for gate switch, inspection access switch, and door locks (output)
	-	No connection
	STD	Step Down (input), hydraulic only
	STU	Step Up (input), hydraulic only
	SAFH	Hoistway Safety String (input)
	SAFC	Car Safety String (input)
	ESC	Hoistway Safety (input)
	DLM	Level Down (input)
	ULM	Level Up (input)
	DZF	Front Door Zone (input)
	2	2 Bus
	2S	2S safety bus
	-	No connection
	PFG	Passing Floor Gong (output)
	GEU	Gong Enable Up (output)
GED	Gong Enable Down (output)	
J14	ESC	Hoistway Safety (input)
	-	No connection
	DZF	Front Door Zone (input)
	-	No connection
	-	No connection

**Table 5.3 HC-CTL Board Terminals**

Connector	Terminal	Description
J15	1	Spare Out 1 ( <b>Do not connect to 1 Bus</b> )
	2	Spare Out 2 ( <b>Do not connect to 2 Bus</b> )
	3	Spare Out 3
	4	Spare Out 4
J16		Used to program the U53 microcontroller
J27 (1-20) upper connector	CCB	Fire Car Call Cancel Button (input)
	FRSA	Fire Service Alternate Initiating Device, machine room (input)
	FRSM	Fire Service Main Initiating Device, all other hoistway fire service initiating devices (input)
	FRES	Fire Service Reset (input)
	2FS	Fire Service Bus
	2FS	Fire Service Bus
	ICPU/GP1	In-Car Panel Inspection Up Direction/General Purpose (Input)
	INCP	In-Car Panel Inspection (Input)
	2HA	Hoistway Access Power (Input)
	2HA	Hoistway Access Power (Input)
	INCT	Car Top Inspection
	ICPD/GP2	In-Car Panel Inspection Down Direction/General Purpose (Input)
	ICTD	Car Top Inspection Down Direction (Input)
	ICTU	Car Top Inspection Up Direction (Input)
	ABD	Bottom Hoistway Access Down Direction (Input)
	ABU	Bottom Hoistway Access Up Direction (Input)
	ATD	Top Hoistway Access Down Direction (Input)
	ATU	Top Hoistway Access Up Direction (Input)
	INA	Hoistway Access Inspection Up Direction (Input)
TAB	Top Access 2nd Pole (Input)	

**Table 5.3 HC-CTL Board Terminals**

Connector	Terminal	Description
J27 21-40 lower connector	DCL	Door Close Limit (Input)
	DOL	Door Open Limit (Input)
	DPM	Door Position Monitor (Input)
	SE	Safety Edge (input)
	NBZ	Nudging Buzzer (output)
	PHE	Photo Eye (input)
	IND	Independent Service (input)
	DCB	Door Close Button (input)
	DOB	Door Open Button (input)
	HLD	Phase II Fire Service Operation Hold (Hold position of 3-position fire service operation switch, output)
	OFF	Phase II Fire Service Operation Off (Default position of 3-position fire service operation switch, output)
	FRS	Smoke/Fire Sensors for all landing that are not main (input)
	FRA	Main Landing Smoke Sensor (input)
	FRON	Fire Recall Operation (input)
	FCS	Phase II Fire Service Operation On (On position of 3-position fire service operation switch)
	FSLI	Fire Service Indicator for Lobby (output)
	FSLC	C.O.P. Fire Service Light (output)
	FWI	Fire Service Buzzer (output)
	2	2 Bus
	2	2 Bus
J42	DCL	MCE connections for Door Operation (See J27)
	DOL	MCE connections for Door Operation (See J27)
	DPM	MCE connections for Door Operation (See J27)
	SE	MCE connections for Door Operation (See J27)
	NBZ	MCE connections for Door Operation (See J27)
	PHE	MCE connections for Door Operation (See J27)
	IND	MCE connections for Door Operation (See J27)
	DCB	MCE connections for Door Operation (See J27)
	DOB	MCE connections for Door Operation (See J27)
HLD	MCE connections for Door Operation (See J27)	

**Table 5.3 HC-CTL Board Terminals**

Connector	Terminal	Description
J43	OFF	MCE connections for Fire Service (See J27)
	FRS	MCE connections for Fire Service (See J27)
	FRA	MCE connections for Fire Service (See J27)
	FRON	MCE connections for Fire Service (See J27)
	FCS	MCE connections for Fire Service (See J27)
	FSLC	MCE connections for Fire Service (See J27)
	FSLC	MCE connections for Fire Service (See J27)
	FWI	MCE connections for Fire Service (See J27)
	1	MCE connections for Fire Service (See J27)
	1	MCE connections for Fire Service (See J27)

**Table 5.4 HC-CTL Board Indicators**

Indicator	Description
NUDG	Nudge output on
DCP	Door Close Power input is high
DCF	Door Close Function input is high
DOF	Door Open Function input is high
DCL	Door Close Limit input is high
DOL	Door Open Limit input is high
DPM	Door Position Monitor input is high
SE	Safety Edge input is high
PHE	Photo Eye input is high
TEST	Test Mode switch is in ON position
IND	Independent Service Operation
DCB	Door Close Button
DOB	Door Open Button
CCB	Fire car call cancel input is active
FCS	Phase II Fire Service Operation On (On position of 3-position fire service operation switch) input is high
HLD	Phase II Fire Service Operation Hold (Hold position of 3-position fire service operation switch) input is high
OFF	Phase II Fire Service Operation Off (Off position of 3-position fire service operation switch) input is high
FWI	Fire Service Buzzer
FSLC	C.O.P. Fire Service Light input is high
FSLC	Fire Service Lobby Light is active
FRA	Fire service alternate initiating device on main landing input is high
FRS	Fire service main landing initiating device input is high
FRSA	Fire service alternate initiating device machine room input is high
FRSM	Fire service alternate initiating device in hoistway input is high

**Table 5.4 HC-CTL Board Indicators**

Indicator	Description
FRON	Fire Recall Operation input is high
FRES	Fire Service Reset input is high
2FS	2FS bus is high
ICPD/GP2	In-Car Panel Inspection Down Direction input is high
ICPU/GP1	In-Car Panel Inspection Up Direction input is high
INCP	In-Car Panel Inspection input is high
ICTD	Inspection Down Direction input is high
ICTU	Inspection Up Direction input is high
INCT	Cartop inspection input is high
ABD	Bottom Hoistway Access Down Direction input is high
ABU	Bottom Hoistway Access Up Direction input is high
ATD	Top Hoistway Access Down Direction input is high
ATU	Top Hoistway Access Up Direction input is high
INA	Inspection Access input is high
2HA	2HA Bus is high
STD	Step Down input is high, hydraulic units only
STU	Step Up input is high, hydraulic units only
DLM	Level Down input is high
ULM	Level Up input is high
DZF	Front Door Zone input is high
2S	2S bus
CSB	Car Stop Bypass activated
SAFC	Car Safety String input is high
SAFH	Hoistway safety string input is high
2	2 Bus is high
DZLV	Car is leveled in door zone
BAB	Bottom Access Pole #2 is high
DLAB	Bottom Door Lock is high
TAB	Top Access Pole #2 is high
DCAB	Bottom access door contact input is active
GS	Gate switch is high
PFG	Passing floor gong output is on
GEU	Gong enable up is on
GED	Gong enable down is on
SUA	Directional Arrow Up output is active
SDA	Directional Arrow Down output is active
SPA	Safety Processor A is fully functional
SPB	Safety Processor B is fully functional
SPC	Safety Processor C is fully functional
FAULT	System Fault - A fault is being detected

**Table 5.4 HC-CTL Board Indicators**

Indicator	Description
UP	Up direction is picked
DN	Down direction is picked
CAR DOOR BYPASS	Car door bypass is active
HOISTWAY DOOR BYPASS	Hoistway door bypass is active
SAFS	SAFS relay is picked
SAFL	SAFL relay is picked

**Table 5.5 HC-CTL Board Jumpers**

Jumper	Description
JP1	Fault Bypass: Open
JP3	SPA Hard Reset: Jumper required only to perform 2K testing
JP4	SPB Hard Reset: Jumper required only to perform 2K testing
JP6	SPC Hard Reset: Jumper required only to perform 2K testing

**Table 5.6 HC-CTL Board Fuses**

Fuse	Description
F2S	2S bus fuse
F2HA	F2HA bus fuse
F2	F2 bus fuse

Table 5.7 HC-CTL Board Test Points

Test Point	Description
1	1 bus (Ground)
2	2 bus (120VAC)
+5V	+5VDC
CDB	Output of Pole #1 of Car door bypass switch
F1	1 bus with an 80mA fuse in series
F2	2 bus with an 80mA use in series
GND	Ground (Common)
HDB	Output of Pole #2 of Hoistway door bypass switch
MABB	Access Bypass Bottom monitor signal
MABG	Access Bypass Gate monitor signal
MABT	Access Bypass Top monitor signal
MCSB	In-car Stop Switch Bypass monitor signal
MDZLV	Output from contact of DZLVA relay
MGB	Output of Pole #2 of Car door bypass switch
MGS	Output of #2 NO contact DZ relay
MHDB	Output of Pole #1 of Hoistway door bypass switch
MRUP	Machine Room Up (Not on print)
MSFS1	SAFS Relay monitor signal
SAFLA	Input to SAFL relay coil
SAFLB	Output from SAFL relay coil
SAFSA	Input to SAFS relay coil
SAFSB	Output from SAFS relay coil

Table 5.8 HC-CTL Board Switches

Switch	Description
S1	Machine Room Inspection (UP/DN)
S2	Machine Room Inspection (INSP/NORM)
S3	Controller Test (TEST/NORM)
S4	Fault Reset
S5	Machine Room Inspection (ENABLE)
SW2	Hoistway Door Bypass
SW3	Car Door Bypass

## HC-MPU Main Processor Board

The HC-MPU board performs control data processing and is responsible for:

- Car operation
- Car communication
- Programming and diagnostics
- Redundancy cycle testing
- System software validation
- Duplexing

Figure 5.5 HC-MPU Main Processor Unit Board

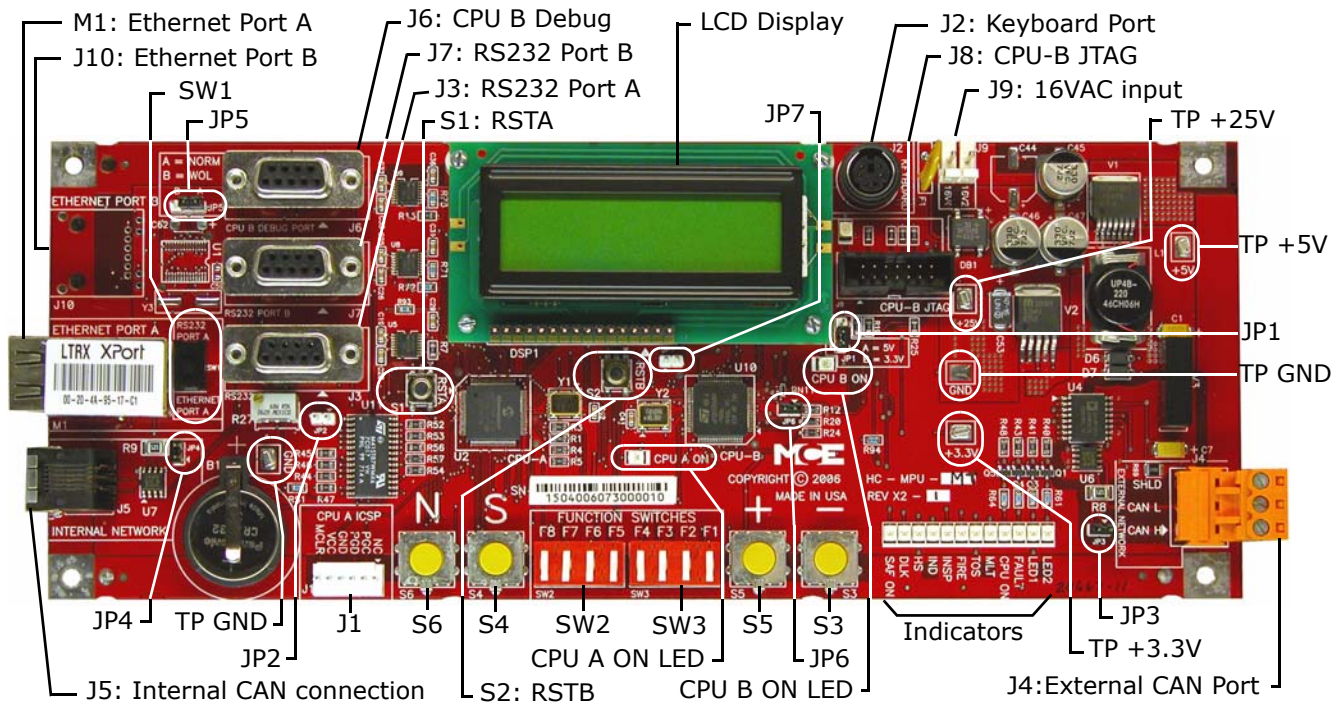

Information displayed on the LCD depends F1 - F8 settings:

- All switches down: Diagnostics mode - scrolling status message, car position, CPU internal memory content.
- Program mode - F1 switch up, others down. Parameter entry. Must be in Inspection.
- External Memory (RAM) - F2 switch up, others down. Review of RAM contents.
- System mode - F3 switch up, others down. Parameter entry for security, load weigher, and other system level functions. System does not have to be in Inspection mode.
- Serial Fixtures - F4 switch up, others down.
- Date/Time, motion diagnostics - F5 switch up, others down.
- ELGO Positioning system - F6 switch up, others down.
- Motion parameter Adjust - F7 up, others down. Traction parameters.
- Status - F8 switch up, others down. Display software version, floor eligibility, load as a percentage of full load.



**Table 5.9 HC-MPU Board Jumpers**

Jumper	Setting	Description
JP1	A	LCD voltage select. A = 5V, B = 3.3V
JP2	-	CPU A reset. No jumper provided, only required for testing
JP3	Configuration dependent	External CAN network termination
JP4	Configuration dependent	Internal CAN network termination
JP5	A	Ethernet Port B (optional)
JP6	Open	JTAG Debug Jumper. Closed = debug mode.
JP7	-	CPU B reset. No jumper provided, only required for testing.

**Table 5.10 HC-MPU Board Switches**

Switches	Description
S1	RSTA: Reset CPU A
S2	RSTB: Reset CPU B
S3	"-" minus push button - decrement setting
S4	"S" push button - select
S5	"+" plus push button - increment setting
S6	"N" push button - next
SW1	Port Selection: RS232 Port A / Ethernet Port A
SW2	DIP Function switches F5 through F8
SW3	DIP Function switches F1 though F4

**Table 5.11 HC-MPU Board Indicators**

Indicators	Description
CPU A ON	CPU A is executing its program
CPU B ON	CPU B is executing its program
LED2	Reserved
LED1	Reserved
FAULT	A fault has been detected.
CPU ON	All processors are fully functional.
MLT	Motor/Valve Limit Timer: The motor/valve limit timer has elapsed.
TOS	Timed Out of Service: The TOS timer has elapsed and the car is out of service.
FIRE	Fire Service: The car is on fire service operation.
INSP	Inspection: The car is on inspection operation.
IND	Independent Service: The car is on independent service.
HS	High Speed: The car is running at high speed.
DLK	Doors Locked: The door lock contacts are made.
SAF ON	Safety On: The safety circuit is made.

**Table 5.12 HC-MPU Board Test Points**

Test Points	Description
GND	0V
+3.3V	+3.3 Vdc measured between this test point and TP GND.
+5V	+5 Vdc measured between this test point and TP GND.
+25V	Unregulated 25Vdc (+/- 2V) from the HC-CHP board

**Table 5.13 HC-MPU Board Terminals**

Connector	Description
J1	Used to program CPU A. IDC connector.
J2	Keyboard Port. Six-pin DIN connector.
J3	RS-232 Port A. Nine-pin D-sub connector.
J4	External CAN Port. Three-pin Weidmuller connector (CAN H, CAN L, SHLD). Signal for CAN connections outside the controller cabinet.
J5	Internal CAN Port. RJ12 connector/cable to the HC-CHP CAN Hub / Power Supply board.
J6	CPU B Debug Port. Nine-pin D-sub connector.
J7	RS-232 Port B. Nine-pin D-sub connector.
J8	Used to program CPU B. Fourteen-pin header connector.
J9	Low voltage AC input (16V). Two-pin IDC connector.
J10	Optional Ethernet Port B. RJ45 connector.
M1	Ethernet Port A. Serial to ethernet conversion device.

### HC-MPU Battery

The battery sustains volatile information when the power is off. Controller operating parameters are stored in non-volatile memory and will not be affected by battery removal. The battery provides 3.3 VDC. If battery voltage falls below 2.2 VDC, the battery should be replaced. If battery replacement is part of a regular maintenance schedule, we recommend it be replaced every two years.

**Table 5.14 HC-MPU Battery**

Type	Original Specification
Sanyo	CR2032, 3V, Mn D2-Li cell

**Replacement:**

1. Shut down power to the controller.
2. Replace the battery on the HC-MPU board.
3. Restore controller power.
4. Reset date and time. [Please refer to “Date/Time, View / Adjust” on page 4-63.](#)

# HC-RDR Rear Door Board

The HC-RDR Rear Door board provides interface and control for rear doors.

Figure 5.6 HC-RDR Rear Door Board

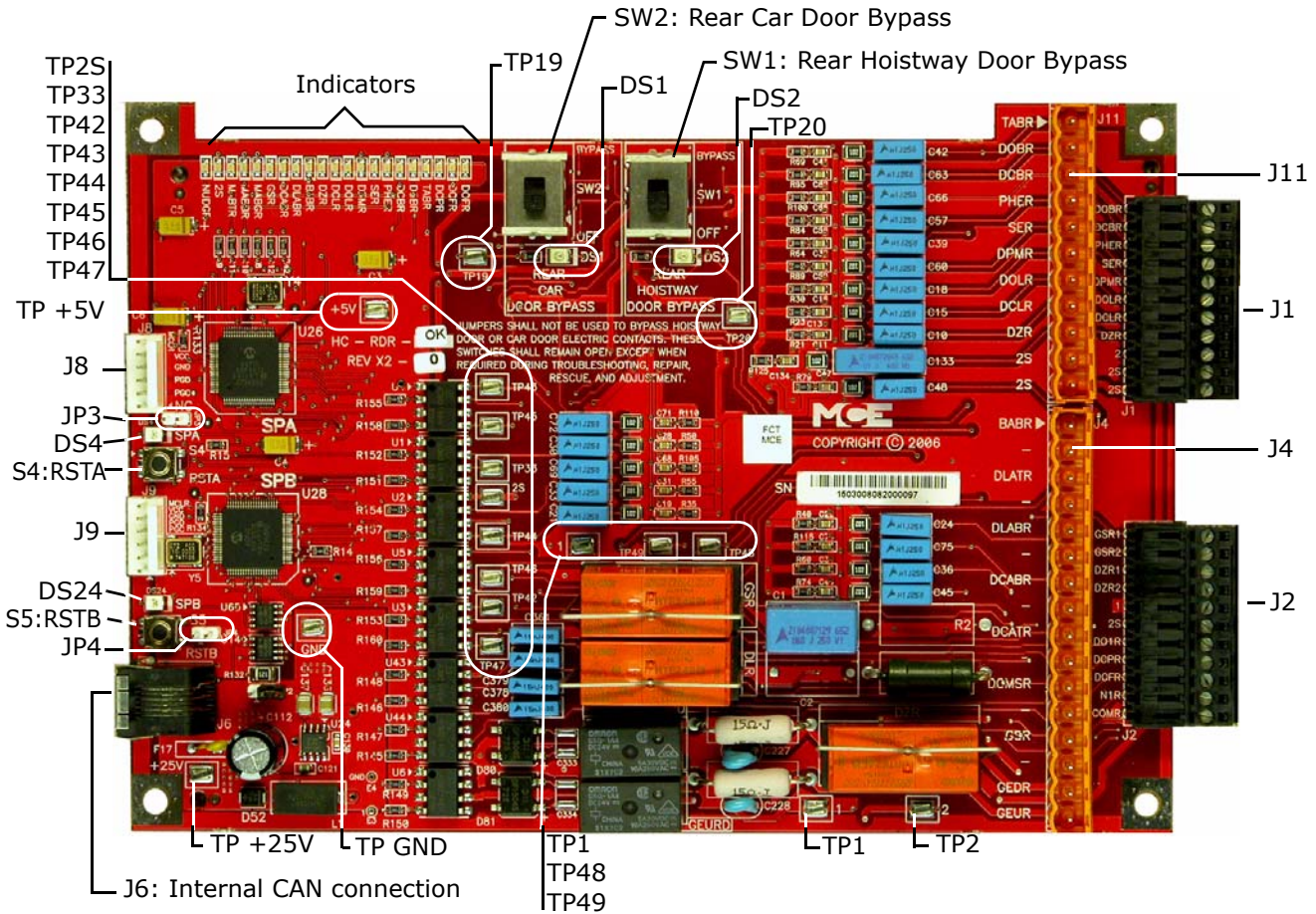

### Switches

- SW1: Rear Hoistway Door Bypass
- SW2: Rear Car Door Bypass
- S4: RSTA - Reset Safety Processor A
- S5: RSTB - Reset Safety Processor B

### Jumpers

- JP2: Internal CAN Network Termination
- JP3: SPA reset. No jumper provided, jumper only required to perform testing.
- JP4: SPB reset. No jumper provided, jumper only required to perform testing.

### Relays

- DLR: Door Lock Relay
- DZR: Door Zone Relay
- GEDRD: Gong Enable Down Rear Door
- GEURD: Gong Enable Up Rear Door
- GSR: Gate Switch Relay

**Table 5.15 HC-RDR Board Terminals**

Connector	Terminal	Description
J1	DOBR	Door Open Button Rear (input)
	DCBR	Door Close Button Rear (input)
	PHER	Photo Eye Rear (input)
	SER	Safety Edge Rear (input)
	DPMR	Door Position Monitor Rear (input)
	DOLR	Door Open Limit Rear (input)
	DCLR	Door Close Limit Rear (input)
	2	2 Bus
	2S	2S Bus
J2	GSR1	Gate Switch String from front doors (output)
	GSR2	Gate Switch String from front doors (input)
	DZR1	Door zone string from front doors (output)
	DZR2	Door zone string from front doors (input)
	1	1 Bus
	2S	2S bus feed (MCE wiring)
	DO1R	Rear door open function (output)
	DCPR	Door close power, rear.
	DCFR	Rear door close function (output)
	N1R	Nudging operation (output)
	COMR	Common for DO1R, DCPR, DCFR, N1R
	J4	BABR
-		No connection
DLATR		Rear top door lock (input)
-		No connection
DLABR		Rear bottom door lock (input)
-		No connection
DCABR		Rear bottom retiring cam door lock (input)
-		No connection
DCATR		Rear top retiring cam door lock (input)
-		No connection
DCMSR		Rear middle retiring cam door lock (input)
-		No connection
GSR		Rear gate switch (input)
-		No connection
GEDR		Rear gong enable down (output)
GEUR	Rear gong enable up (output)	
J8		Used to program the SPA microcontroller
J9		Used to program the SPB microcontroller

**Table 5.15 HC-RDR Board Terminals**

Connector	Terminal	Description
J11	TABR	Top Access Rear Door Lock Bypass (input)
	DOBR	Door Open Button Rear (input)
	DCBR	Door Close Button Rear (input)
	PHER	Photo Eye Rear (input)
	SER	Safety Edge Rear (input)
	DPMR	Door Position Monitor Rear (input)
	DOLR	Door Open Limit Rear (input)
	DCLR	Door Close Limit Rear (input)
	DZR	Door Zone Rear (input)
	2S	2S bus (output)
	2S	2S bus (output)

**Table 5.16 HC-RDR Board Indicators**

Indicator	Description
DOFR	Door open function rear input is high
DCFR	Door close function rear input is high
DCPR	Door close power rear input is high
TABR	Top access rear door lock bypass input is high
DOBR	Door open button rear input is high
DCBR	Door close button rear input is high
PHER	Photo eye rear input is high
SER	Safety edge rear input is high
DPMR	Door position monitor rear input is high
DOLR	Door open limit rear input is high
DCLR	Door close limit rear input is high
DZR	Door zone rear input is high
BABR	Bottom access rear door lock bypass input is high
DLABR	Rear bottom door lock input is high
DCABR	Rear bottom retiring cam door lock input is high
GSR	Rear gate switch input is high
MABGR	Access Bypass Gate Rear monitor signal
MABBR	Access Bypass Bottom Rear monitor signal
MABTR	Access Bypass Top Rear monitor signal
2S	2S bus is high
NUDGR	Nudge rear output on
DS1	Rear Car Door Bypass
DS2	Rear Hoistway Door Bypass
DS4	SPA
DS24	SPB

**Table 5.17 HC-RDR Board Test Points**

Test Points	Description
GND	0V
+5V	+5 Vdc measured between this test point and TP GND.
+25V	Unregulated 25Vdc from the HC-CHP board
1	1 Bus (common)
2	2 Bus (120 Vac)
2S	2S Bus
19	120Vac = Car Door Bypass (input) is ON
20	120Vac = Hoistway Door Bypass (input) is ON
33	120Vac = Access Bypass gate (output) is ON
42	120Vac = Access Bypass Top (output) is ON
43	120Vac = Access Bypass Button (output) is ON
44	120Vac = Gate Switch Bypass (output) is ON
45	120Vac = Hoistway Door Bypass (output) is ON
46	120Vac = Top Access Bypass (output) is ON
47	120Vac = Bottom Access Bypass (output) is ON
48	120Vac = Gate Switch Relay is ON
49	120Vac = Door Lock Relay is ON

## HC-UIO Universal Input/Output Board

Depending upon the software installed, HC-UIO boards may be used for programmable inputs and outputs (16 per board), car and hall calls, door operator interface, or dispatching.

Figure 5.7 HC-UIO Universal Input/Output Board

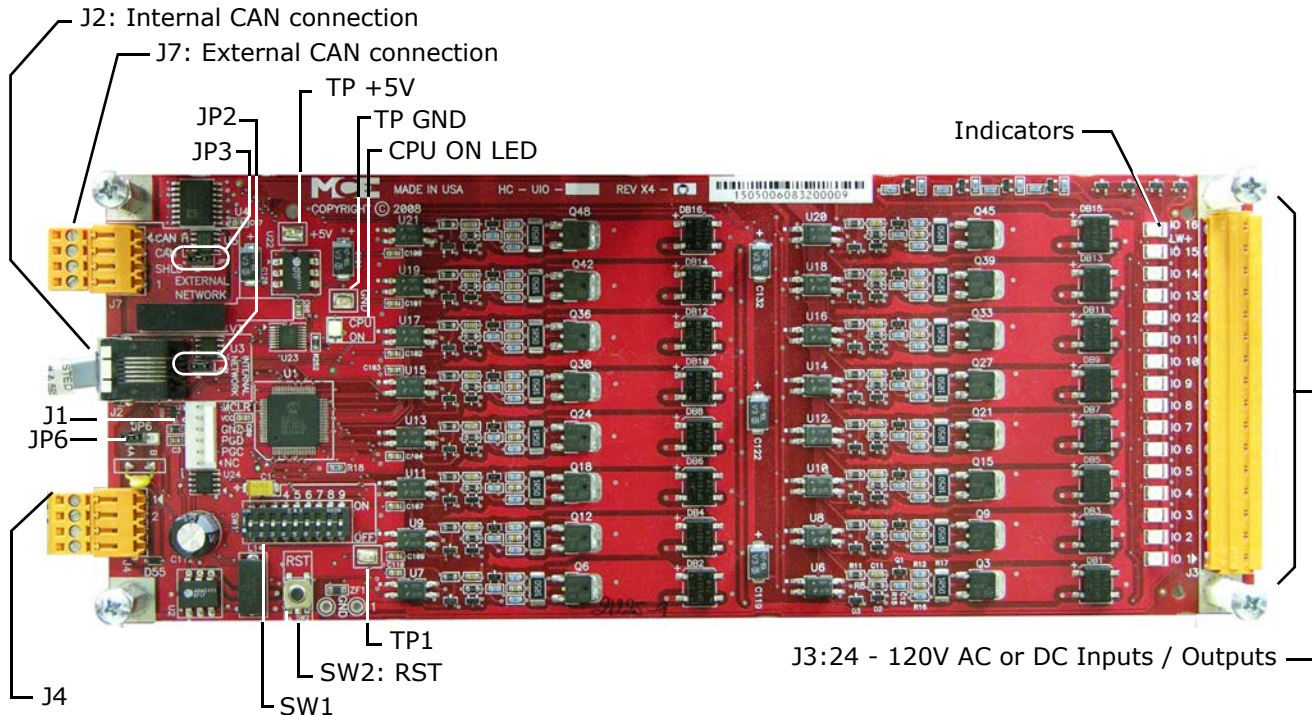

### Switches

- DIP SW1:
  - Switches 1 through 6 = Board ID (see “HC-UIO Board Call Assignments” on page 5-58) and (see “HC-UIO Spare Input / Output Assignments” on page 5-60)
  - Switches 7 & 8 = Baud rate (see “HC-UIO Board DIP SW1 Switches 7 and 8” on page 5-59)
  - Switch 9 = Input levels (see “HC-UIO Board DIP SW1 Switch 9 for I/O Boards” on page 5-59)
- Sw2: RST - Processor reset

### Jumpers

- JP2: Internal CAN Network Termination
- JP3: External CAN Network Termination
- JP6: Selects voltage reference
  - A = 120Vac power supplied by J4 (default)
  - B = 24Vdc power supplied by CAN bus

### Test Points

- GND: Digital Ground - 0 V
- +5V: +5 Vdc measured between this test point and TP GND.
- 1: 1 Bus (common)

**Indicators**

- CPU ON: The microcontroller is executing its program.
- IO1 - IO16: Indicate the state of the input or output, active or inactive.

**Terminals**

- J1: Used to program the microcontroller (IDC connector).
- J2: Internal CAN signal and power (RJ12 connector).
- J3: IO1 - IO16. 24v to 120v AC or DC inputs or outputs.
- J4: 1 bus and 2 bus. Weidmuller connector.
- J7: External CAN Network (Weidmuller connector).

**Call Inputs and Outputs**

**Table 5.18 HC-UIO Board Call Assignments**

Board ID	SW1 Setting						IO 1 to IO 16
	1	2	3	4	5	6	
00	Off	Off	Off	Off	Off	Off	HC-UIO boards numbered 00 through 31 are used for call related IO. The associated SW1 switch setting is shown to the left. Terminal assignments, beginning with terminal IO 1 through IO 16 on board 00, followed by terminal IO 1 through IO 16 on board 01, etc., are made in the following order: nn = TOP LANDING SERVED • PIs PI1 - PI(nn) • Front car calls 101 - 1(nn) • Rear car calls 101R - 1(nn)R • Front down hall calls 502 - 5(nn) • Front up hall calls 601 - 6(nn-1) • Rear down hall calls 502R - 5(nn)R • Rear up hall calls 601R - 6(nn-1)R
01	On	Off	Off	Off	Off	Off	
02	Off	On	Off	Off	Off	Off	
03	On	On	Off	Off	Off	Off	
04	Off	Off	On	Off	Off	Off	
05	On	Off	On	Off	Off	Off	
06	Off	On	On	Off	Off	Off	
07	On	On	On	Off	Off	Off	
08	Off	Off	Off	On	Off	Off	
09	On	Off	Off	On	Off	Off	
10	Off	On	Off	On	Off	Off	
11	On	On	Off	On	Off	Off	
12	Off	Off	On	On	Off	Off	
13	On	Off	On	On	Off	Off	
14	Off	On	On	On	Off	Off	HC-UIO board terminal assignments are determined by the settings of the following BASIC FEATURE MENU (see 4-13): • TOP LANDING SERVED? • HC-RDR BOARD ON THIS CAR? • CAR SERVES FRNT/FLR 1 (- 32)? • CAR SERVES REAR/FLR 1 (- 32)? And also (see 4-15): • DISCRETE PI'S ON UIO? • DEDICATED PI BOARD? (allows first one or two UIO boards to be dedicated to PI's alone) • SERIAL COP BOARD HC-CPI?
15	On	On	On	On	Off	Off	
16	Off	Off	Off	Off	On	Off	
17	On	Off	Off	Off	On	Off	
18	Off	On	Off	Off	On	Off	
19	On	On	Off	Off	On	Off	
20	Off	Off	On	Off	On	Off	
21	On	Off	On	Off	On	Off	
22	Off	On	On	Off	On	Off	
23	On	On	On	Off	On	Off	
24	Off	Off	Off	On	On	Off	
25	On	Off	Off	On	On	Off	
26	Off	On	Off	On	On	Off	
27	On	On	Off	On	On	Off	
28	Off	Off	On	On	On	Off	
29	On	Off	On	On	On	Off	
30	Off	On	On	On	On	Off	
31	On	On	On	On	On	Off	



### HC-UIO DIP SW1 Switches 7, 8 and 9 Settings

On the HC-UIO Board (Rev X4 and later), DIP SW1 switches 7 and 8 set the baud rate at which the CAN bus communicates with this board.

**Table 5.19 HC-UIO Board DIP SW1 Switches 7 and 8**

Sw 7	Sw 8	Baud Rate	Description
OFF	OFF	500 kbps	For boards inside the controller, RJ12 cable from J2 on HC-UIO board to HC-CHP board Internal Network J1 through J10.
ON	OFF	250 kbps	For boards on the cartop, RJ12 cable from J2 on HC-UIO board to MC-LSI board LAN connectors. <b>Caution:</b> Do not connect to J3 on the MC-LSI (Landing System) board.
OFF	ON	125 kbps	Future use

On the HC-UIO Board (Rev X4 and later), DIP SW1 switch 9 sets the activation threshold for inputs IO1 through IO16..

**Table 5.20 HC-UIO Board DIP SW1 Switch 9 for I/O Boards**

Sw 9	Description
OFF	Sets Input activation threshold to 18 Volts ac or dc
ON	Sets Input activation threshold to 55 to 65 Volts ac

**Table 5.21 HC-UIO Board DIP SW1 Switch 9 for Call Boards**

Sw 9	Description
OFF	Sets Input activation threshold to 0.6 Volts ac or dc
ON	Sets Input activation threshold to 0.2 Volts ac or dc

### HC-UIO Used for Calls

When HC-UIO boards are used for hall or car calls, the brightness of the LEDs associated with inputs and outputs has significance.

Level 0 - LED Off

- The input is not active and the output is not latched on.

Level 1 - LED medium brightness

- The input is not active and the output is latched on.

Level 2 - LED full brightness

- The input is active and the output may or may not be latched on.

### Hospital Emergency Operation I/O

I/O 1 through I/O 4 on UIO Board #16 are used for hospital emergency operation connections HEO, HWI, HSEL, and HOSPH2 respectively. [Please refer to "HOSPITAL EMERG. OPERATION?" on page 4-45.](#)

### Spare Inputs and Outputs

Spare Inputs and Outputs available on the Motion 4000 controller are described in Section 4. (Please refer to “Spare Inputs Menu” on page 4-26 and 4-35, outputs) The first ten Spare Inputs (SP1 through SP10) are assigned to terminals SPIN1 through SPIN10 on the HC-CTL board (connectors J6 and J10). The first four Spare Outputs (OUT1 through OUT4) are assigned to terminals 1 through 4 (J15) on the HC-CTL board. The remainder of the Spare Inputs and Outputs are assigned to HC-UIO boards numbered 32 through 36 as shown in the table below.

**Table 5.22 HC-UIO Spare Input / Output Assignments**

Board ID	SW1 Setting						IO Terminals								IO Terminals							
	1	2	3	4	5	6	1	2	3	4	5	6	7	8	9	10	11	12	13	14	15	16
32	Off	Off	Off	Off	Off	On	SP11	SP12	SP13	SP14	SP15	SP16	SP17	SP18	OUT5	OUT6	OUT7	OUT8	OUT9	OUT10	OUT11	OUT12
33	On	Off	Off	Off	Off	On	SP19	SP20	SP21	SP22	SP23	SP24	SP25	SP26	OUT13	OUT14	OUT15	OUT16	OUT17	OUT18	OUT19	OUT20
*34	Off	On	Off	Off	Off	On	SP27	SP28	SP29	SP30	SP31	SP32	SP33	SP34	OUT21	OUT22	OUT23	OUT24	OUT25	OUT26	OUT27	OUT28
*35	On	On	Off	Off	Off	On	SP35	SP36	SP37	SP38	SP39	SP40	SP41	SP42	OUT29	OUT30	OUT31	OUT32	OUT33	OUT34	OUT35	OUT36
36	Off	Off	On	Off	Off	On	SP43	SP44	SP45	SP46	SP47	SP48	SP49	SP50	OUT37	OUT38	OUT39	OUT40	OUT41	OUT42	OUT43	OUT44
37	On	Off	On	Off	Off	On																
38	Off	On	On	Off	Off	On																
39	On	On	On	Off	Off	On																
40	Off	Off	Off	On	Off	On																
41	On	Off	Off	On	Off	On																
42	Off	On	Off	On	Off	On																
43	On	On	Off	On	Off	On																
44	Off	Off	On	On	Off	On																
45	On	Off	On	On	Off	On																
46	Off	On	On	On	Off	On																
47	On	On	On	On	Off	On																
48	Off	Off	Off	Off	On	On																
49	On	Off	Off	Off	On	On																
50	Off	On	Off	Off	On	On																
51	On	On	Off	Off	On	On																
52	Off	Off	On	Off	On	On																
53	On	Off	On	Off	On	On																
54	Off	On	On	Off	On	On																
55	On	On	On	Off	On	On																
56	Off	Off	Off	On	On	On																
57	On	Off	Off	On	On	On																
58	Off	On	Off	On	On	On																
59	On	On	Off	On	On	On																
60	Off	Off	On	On	On	On																
61	On	Off	On	On	On	On																
62	Off	On	On	On	On	On																
63	On	On	On	On	On	On																

## MC-CPI Car Panel Interface Board

The MC-CPI board, mounted in the car operating panel, converts the discrete closures from the panel buttons and switches to data on the CAN serial bus and passes it through the MC-LSI Landing System Interface board on the cartop, up the traveler to the car controller. Additional MC-CPI boards are used to accommodate rear doors or installations with many floors, COP buttons, and lamps.

Spare assignable inputs to and outputs from CPI boards are available depending upon system configuration, front control panel only or front and rear control panels.

- F1 menu, Serial COP Board HC-CPI = YES and F1, HC-RDR Board on this Car = NO: CPI board assignable inputs show up in the Spare Inputs menu as CPI F (front panel board) I10 - I16; CPI FX (front panel extender board) I1 - I7. Spare outputs (Spare Outputs menu) will be prefaced with an 'O' for Output.
- F1 menu, Serial COP Board HC-CPI = YES and F1, HC-RDR Board on this Car = YES: CPI board assignable inputs show up in the Spare Inputs menu as CPI F (front panel board) I10 - I16 and CPI-R (rear panel board) I10 - I16. Spare outputs (Spare Outputs menu) will be prefaced with an 'O' for Output.

If the job has MC-CPI boards, unused spare inputs to and outputs from these boards must be set to NOT USED. If controller software is upgraded in the field, it is very important to check programmable CPI board inputs and outputs and verify unused connections are set to NOTUSED. [Please refer to "Spare Inputs Menu" on page 4-26.](#)



### Caution

Spare inputs and outputs used on the CPI boards must be 24VDC, not to exceed 6 Watts.

## Installation Instructions

1. Turn the power off at the main disconnect.
2. Mount the MC-CPI board(s) inside the COP using the supplied hardware and providing sufficient clearance for the components.



### Caution

Do not replace C-RJ11-CAN-15 cables between the MC-CPI and MC-LSI with RJ11 cables purchased locally. These cables **MUST** be replaced with C-RJ11-CAN-15 supplied by MCE. For a replacement cable, please contact MCE technical support.

3. Refer to the prints for the job to wire the MC-CPI board. An example of a typical wiring print is included in this instruction ([Please refer to "Example: MC-CPI Wiring" on page 5-64](#) and [Please refer to "MC-CPI Serial Car Operating Panel Board" on page 5-62](#)).



### Caution

This system is designed for 24 VDC circuits only! **Do not connect 120 VAC or DC to any terminal on the MC-CPI board.** Connect only the 24V power from connector J6 (24V CUSTOMER LOAD SUPPLY) to the load. ([Please refer to "MC-CPI Board Details" on page 5-63](#) and [Please refer to "Example: MC-CPI Wiring" on page 5-64](#)).

Figure 5.8 MC-CPI Serial Car Operating Panel Board

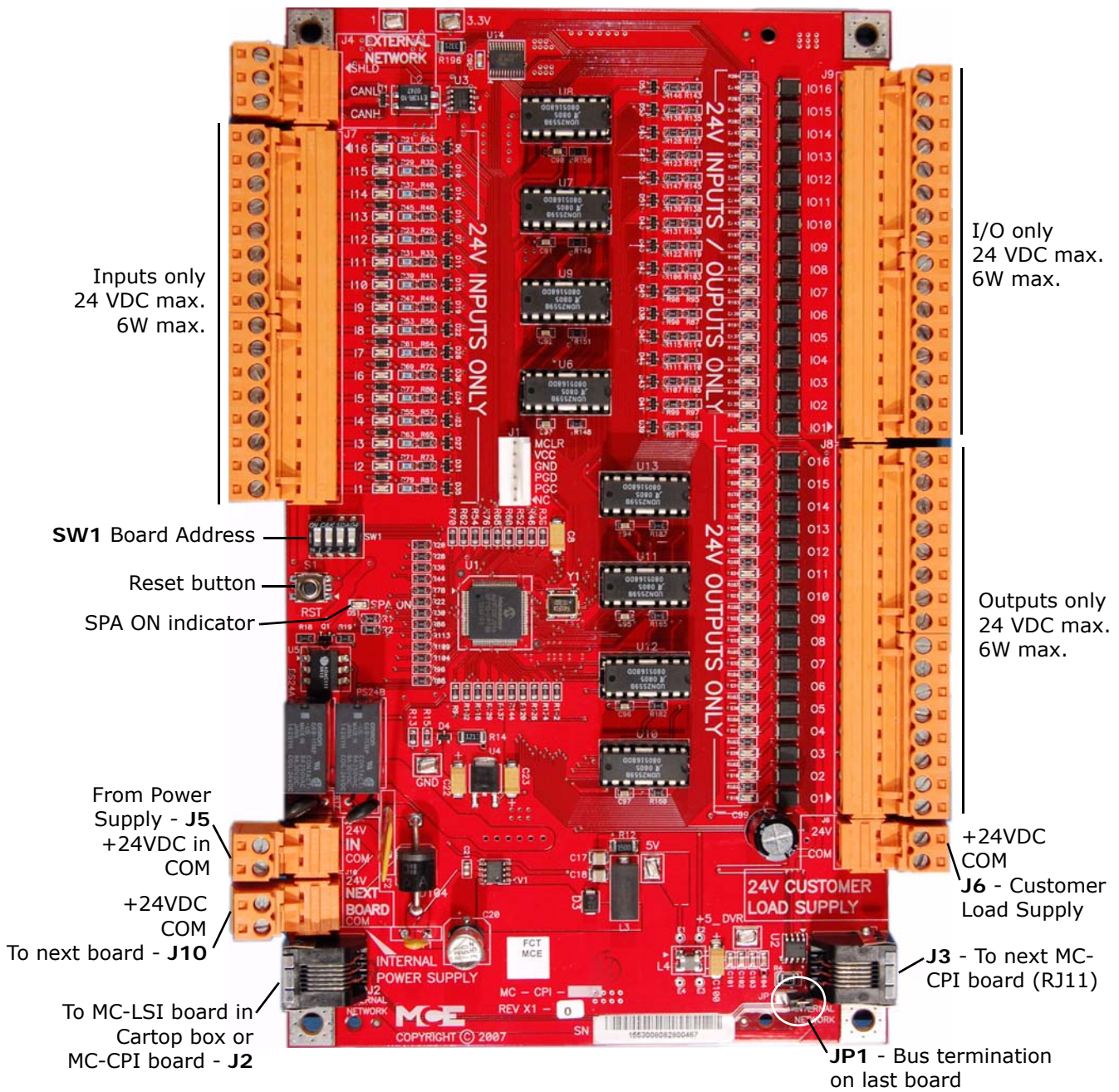

**Caution**

**This system is designed for 24 VDC circuits maximum. Do not connect 120VAC or DC to any terminal on this board at any time.**

**MC-CPI Board Details**

- **24V Inputs Only:** Typical circuit for terminals I1 through I16.

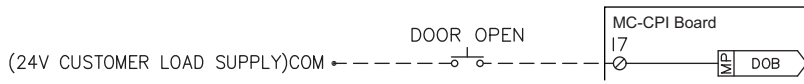

- **24V Outputs Only:** Typical circuit for terminals O1 through O16.

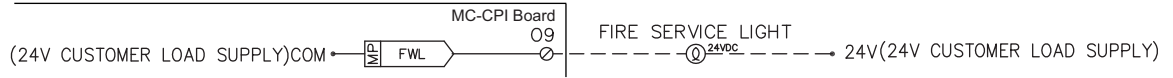

- **24V Inputs/Outputs Only:** Typical circuit for terminals IO1 through IO16.

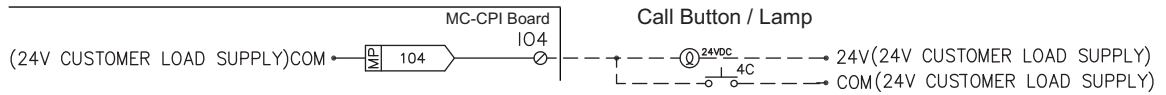

- **Board address switches:** Four-position DIP switch SW1 provides a unique address for each CPI board (you should never have two CPI boards with the same SW1 setting).



DIP 1	Front COP Boards				Rear COP Boards			
Board	SW1	SW2	SW3	SW4	SW1	SW2	SW3	SW4
1	Off	Off	Off	Off	Off	Off	On	Off
2	On	Off	Off	Off	On	Off	On	Off
3	Off	On	Off	Off	Off	On	On	Off
4	On	On	Off	Off	On	On	On	Off

- **24V Power:** The 24V power supply from the cartop box must be connected to the 24V IN connector on the first MC-CPI board. If additional boards are used, they are connected to 24V as shown below. Load connections (power source for buttons and switches in the car panel) can be made to any of the boards at the 24V CUSTOMER LOAD SUPPLY connector as long as load current at any one board is not more than 4A.

- **CAN Bus termination:** Jumper JP1 terminates the CAN bus in the correct impedance for CAN signal transmission.
  - If more than one CPI board is used, ONLY the last board in the CAN string should have jumper JP1 plugged in. (If there is only one CPI board, it must have JP1 plugged in.)

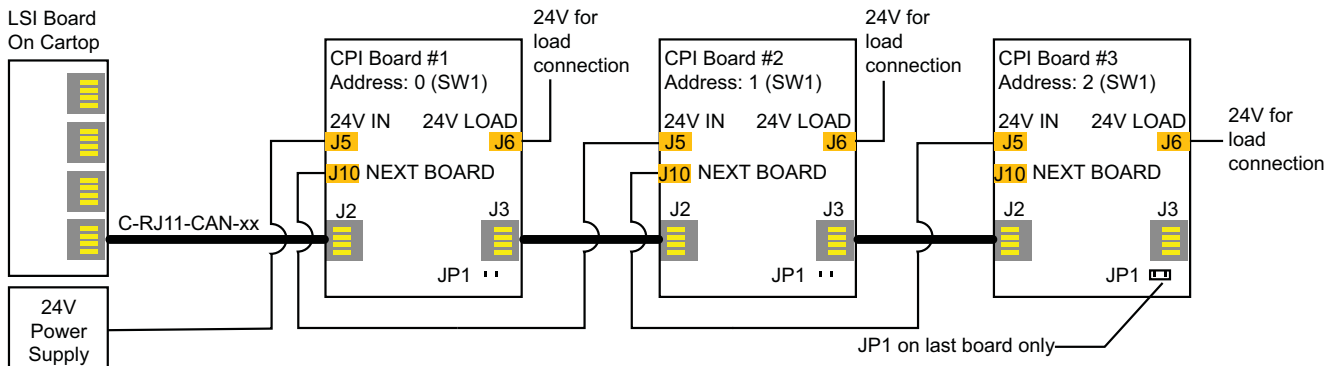
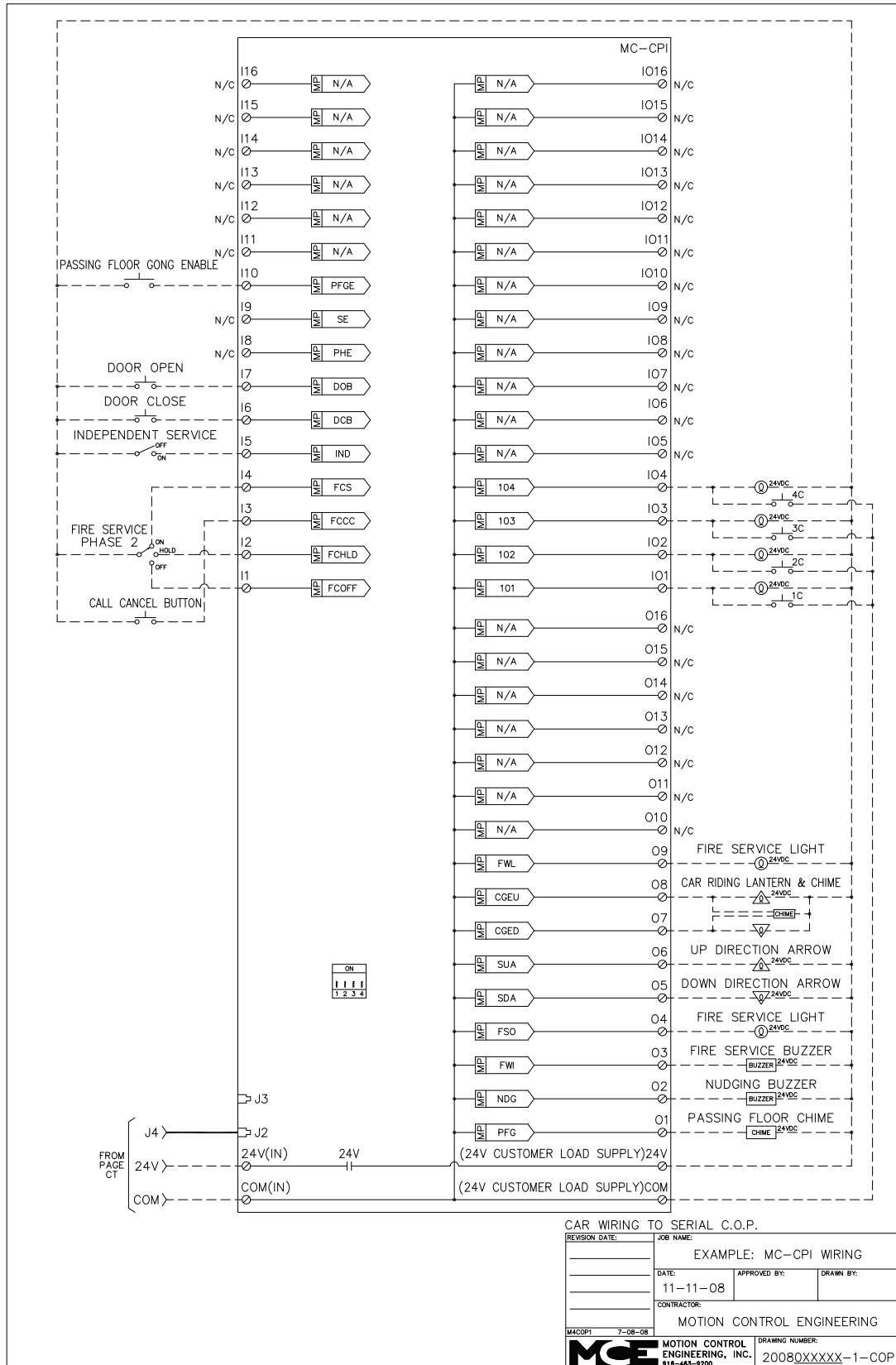

Figure 5.9 Example: MC-CPI Wiring



CAR WIRING TO SERIAL C.O.P.

REVISION DATE:	JOB NAME:		
	EXAMPLE: MC-CPI WIRING		
DATE:	APPROVED BY:	DRAWN BY:	
11-11-08			
CONTRACTOR:			
MOTION CONTROL ENGINEERING			
MACCPI 7-08-08	DRAWING NUMBER:		
<b>MCE</b> MOTION CONTROL ENGINEERING, INC. 918-468-9200	20080XXXXX-1-COP		

## Before Applying Power

Prior to applying power to the MC-CPI board(s):

1. Disconnect all terminal connectors from the MC-CPI boards (I/O connections, internal network and power connections (24V and COM terminals).
2. Apply power to the system.
3. Using a multimeter, check each of the wires to be connected to the MC-CPI boards as follows:
  - **Input circuits (switches, buttons, dry contacts):** Using the VDC setting referenced to 1 bus (common), probe each input circuit. The reading should be either 24VDC or floating.
  - **Output circuits (indicators, buzzers, chimes):** Using the VDC setting referenced to 1bus (common), probe each output circuit. The voltage reading should be approximately 24VDC.



### Caution

This system is designed for 24 VDC circuits only! **Do not connect 120 VAC or DC to any terminal on the MC-CPI board.** Connect only the 24V power from connector J6 (24V CUSTOMER LOAD SUPPLY) to the load ([Please refer to “MC-CPI Board Details” on page 5-63](#) and [Please refer to “Example: MC-CPI Wiring” on page 5-64](#)).

---

4. Power down the system.
5. Install the C-RJ11-CAN cable from J2 (Internal Network) on the MC-CPI board to the MC-LSI (Landing System Interface board) in the cartop box.
6. Install the MC-CPI board I/O connections (I/O terminals).
7. Install the MC-CPI board power connections (24V and COM terminals).



### Caution

To avoid damage to the MC-CPI boards, the system must be powered down before connecting and disconnecting the MC-CPI board power connections (unplugging and plugging in the 24V and COM terminals).

---

8. Apply power to the system and verify that:
  - The MC-CPI board SPA indicator is ON (green).
  - The relay closes and supplies 24VDC to the 24V CUSTOMER LOAD SUPPLY terminals.

## MC-LSI Landing System Interface Board

The MC-LSI mounts in the cartop box and provides a connection point for the landing system and for the Car Panel Interface board (HC-CPI) if one is used. The MC-LSI board receives 24 VDC power from an external power supply operating off the controller 2 Bus (120 VAC). In turn, the LSI board provides power to the landing system and to any Universal I/O boards that might be used on the cartop through the CAN connections to those components. A shielded, external CAN connection runs from the LSI board, through the traveler, to the Motion 4000 controller.

Figure 5.10 MC-LSI Landing System Interface Board

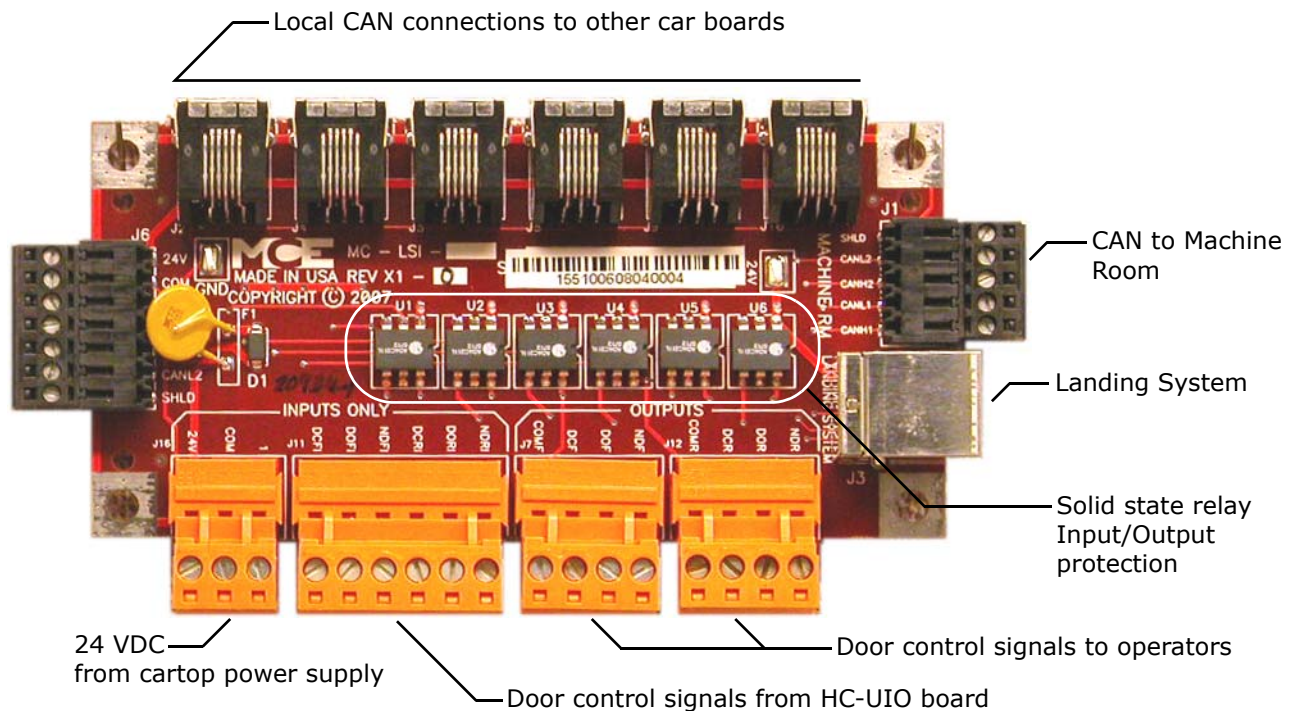

### LSI Connections

- Local CAN: CAN signal and power to additional cartop box boards (HC-UIO, MC-CPI, etc.)
- CAN to Machine Room: Redundant CAN connections to/from machine room
- Landing System: CAN connections to/from landing system
- Door Signals from cartop HC-UIO:
  - NDRI: Nudging, rear
  - DORI: Door open, rear
  - DCRI: Door close, rear
  - NDFI: Nudging, front
  - DOFI: Door open, front
  - DCFI: Door close, front
- Door Signals to operators:
  - NDR: Nudging, rear
  - DOR: Door open, rear
  - DCR: Door close, rear
  - COMR: Common
  - NDF: Nudging, front
  - DOF: Door open, front
  - DCF: Door close, front
  - COMF: Common



## SC-3HN Three Input Serial Hall Call Node Board

The SC-3HN board is used to provide serial hall calls for Motion controllers. The SC-3HN provides analog inputs and outputs for the hall call buttons and LEDs and a CAN connection to the Motion group. Refer to the drawings package for connection instructions to your fixtures.

Figure 5.11 SC-3HN Three Input Serial Hall Call Node Board

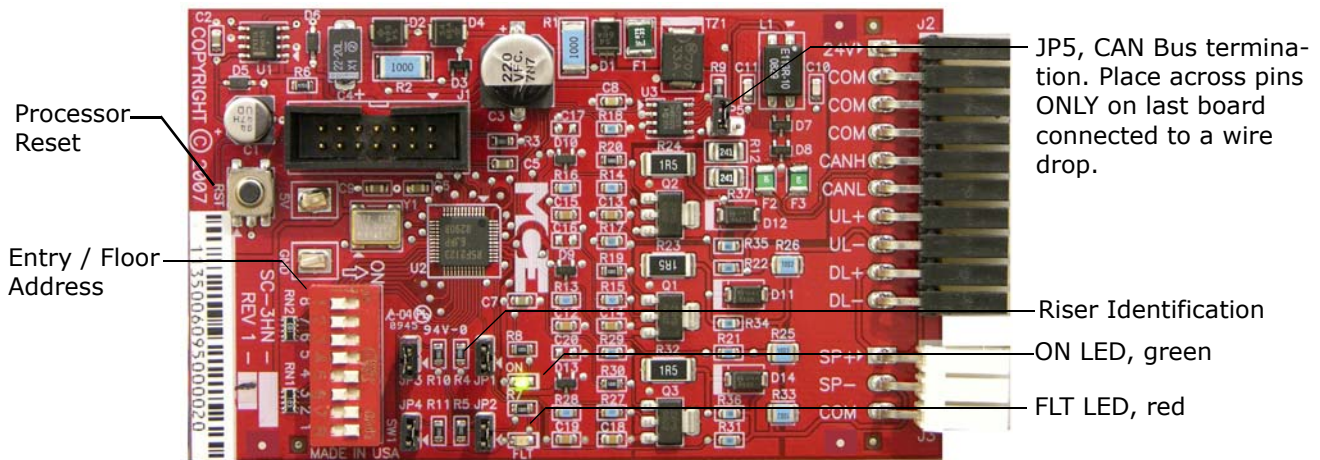

## Call Bus Conditions

In the dispatcher, the serial hall call CAN Bus originates on connectors J16 and/or J17 on the HC-CHP board. The two are electrically identical. If more than two physical connection points are required, a CAN Bus may be paralleled through the Panel Mount Terminal (PMT) strip. Refer to the drawings for the particular job.

- Eight risers are supported; four Main and four Auxiliary.
- Each hoistway wire drop consists of a twisted pair for signals and one wire each for 24V power and common. A wire drop can support more than one riser.
- Settings on each SC-3HN board determine which riser it belongs to, its floor address, and whether it is associated with the Front or Rear car entry.
- SC-3HN boards with the same floor address and entry association will register the same call and light indicators. Each must have a different riser ID but within the same riser group (Main or Auxiliary).
- Main risers A - D use riser IDs 7 - 4. Auxiliary risers A - D use riser IDs 3 - 0.

## General Installation

All SC-3HN connections are at one end of the board. One board is installed in each hall call panel electrical box. The board is shipped in an anti-static bag.

1. Make connections to the hall call buttons and indicators. (See following page.)
2. Make connections to the signal/power drop. (See following page.)
3. Set floor number and door (F/R) location, [5-69](#).
4. Set riser assignment, [5-69](#).
5. Last board on wire drop only: Place a jumper on JP5. All other boards: Ensure jumper NOT placed across JP5 pins, [5-69](#).
6. Insert board in anti-static sleeves and tape closed using supplied ESD sticker.
7. Tuck bag/board into electrical box and re-install hall call.

Figure 5.12 Hall Call Node Wiring

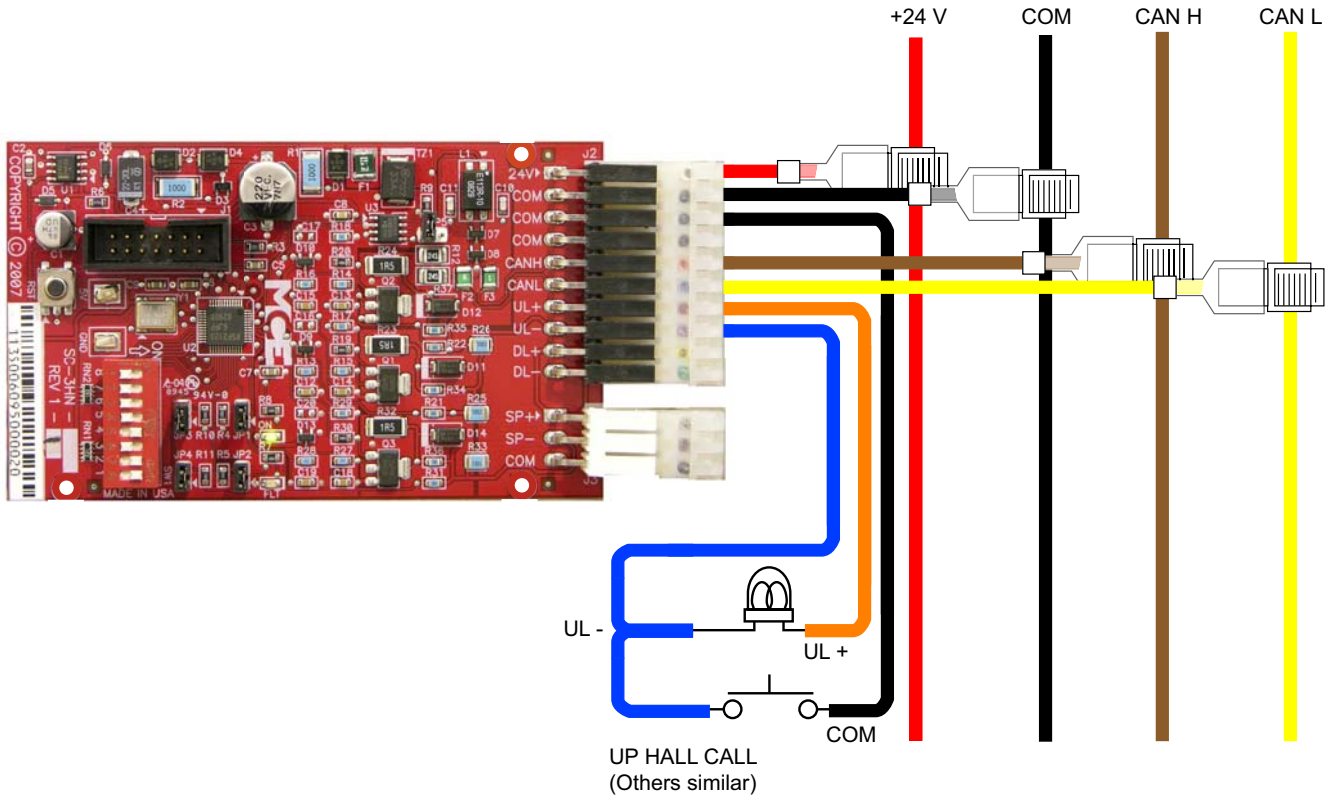

Table 5.23 Hall Wiring Colors

Color	Signal
red	+24V
black	common
brown	CAN H
yellow	CAN L
orange	UL+
blue	UL-
violet	DL+
green	DL-
gray	SP+
white	SP-

## Addressing and CAN Bus Termination

Set SC-3HN addresses as shown in the job prints for the installation. Generic examples are provided below.

### Riser Assignment

There are four Main risers and four Auxiliary risers. Jumper locations JP3, JP2, and JP1 are used to assign the appropriate riser to the SC-3HN board. In the following table, a “1” indicates a jumper in place.

Table 5.24 Riser Assignment by Jumper Binary Representation

JP3	JP2	JP1	Riser
1	1	1	Main A (Binary value 7)
1	1	0	Main B (Binary value 6)
1	0	1	Main C (Binary value 5)
1	0	0	Main D (Binary value 4)
0	1	1	Auxiliary A (Binary value 3)
0	1	0	Auxiliary B (Binary value 2)
0	0	1	Auxiliary C (Binary value 1)
0	0	0	Auxiliary D (Binary value 0)

### Floor Number and Front or Rear Opening

DIP switch SW1, switches 1 through 7 set the floor address for the board, beginning with Floor 1. Switch 8 selects Front or Rear opening.

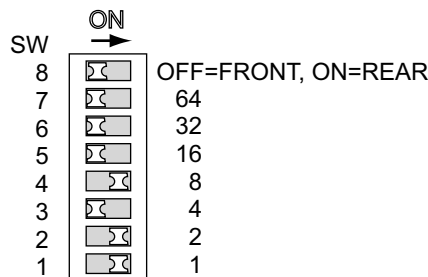

When setting addresses, use the values silk-screened on the circuit board, not those shown on the DIP switch.

Floor address example = 11

ON switch adds its value to floor address.

### Baud Rate

Jumper JP4 is reserved for future use to select a different CAN Bus baud rate should it become necessary. For now, the only option is to leave the JP4 jumper in place, setting baud rate to 125 kbps.

### CAN Bus Termination

The CAN Bus must be terminated ONLY ON THE LAST SC-3HN connected to the wire drop (farthest board from Dispatcher).



JP5 OFF/Unterminated  
All but last board

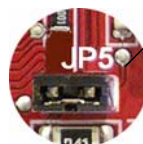

JP5 ON/Terminated  
Last board on wire drop ONLY.

### On Board Diagnostics

Two LEDs provide diagnostic information: The ON LED (green) and the FLT LED (red).

#### ON LED

The ON LED reflects power/communications status.

- ON: Group communications OK
- OFF: Board is not receiving power or has no software loaded.
- Blinking: Communications error - more than ten seconds have passed without a message from the group dispatcher.

#### (FLT) FAULT LED

The FLT LED reflects the status of the analog outputs.

- ON steady: Internal fault -
  - Replace board if problem persists
- OFF: No Errors detected.
- Blinking: Output overload or disconnection. Pressing the Reset button on the SC-3HN board will clear a blinking Fault LED.
  - Overload: Excessive current draw. Resets when current draw is corrected and call button is pressed again.
  - Not Connected: The output is on (button pressed) but nothing is connected to the UL- or DL- output. Resets when the lamp is connected and the call button is pressed again.
  - Output Shorted: If short is very quick, the LED will flash. Pressing the call button for a few moments will cause the board to reboot. Resets when the short is removed and the call button is pressed again.

#### Note

Please refer to the Motion Group Manual, 42-02-G006, for configuration information relating to hall calls.

## TC-MPI Board

The Motion Processor Interface board provides serial and discrete interface to selected AC or DC drives. Redundant safety processors are also on this board as well as the connection points for seismic and earthquake devices and for an emergency brake/rope gripper if one is used.

There are three, independent safety processors. Working in conjunction with position and speed feedback sensors, and continuously monitoring one another, the three prevent the elevator from starting or bring it to an emergency stop if position/speed related errors are detected.

- SPA (Safety Processor A): Working in conjunction with the PS1 positioning sensor (one of two positioning sensors on the cartop), SPA performs Emergency Terminal Switch functions and continuously monitors position and speed data from its sensor as well as continuously comparing this data with data reported to SPB.
- SPB (Safety Processor B): Working in conjunction with the PS2 positioning sensor (one of two sensors on the cartop), SPB performs Normal Terminal Switch functions and monitors PS2 position and speed data, continuously comparing this with data reported to SPA.
- MP (Motion Processor): Primary functions are drive and speed control. Additionally, monitors speed and direction from motor rotation and from PS1 positioning sensor. The MP checks that both SPA/PS1 and SPB/PS2 systems are functioning properly by comparing their data and ensuring that any discrepancy is within a fixed tolerance. Using PS1 data, the MP is also able to perform redundant checking of the ETS function.

5

Figure 5.13 TC-MPI Motion Processor

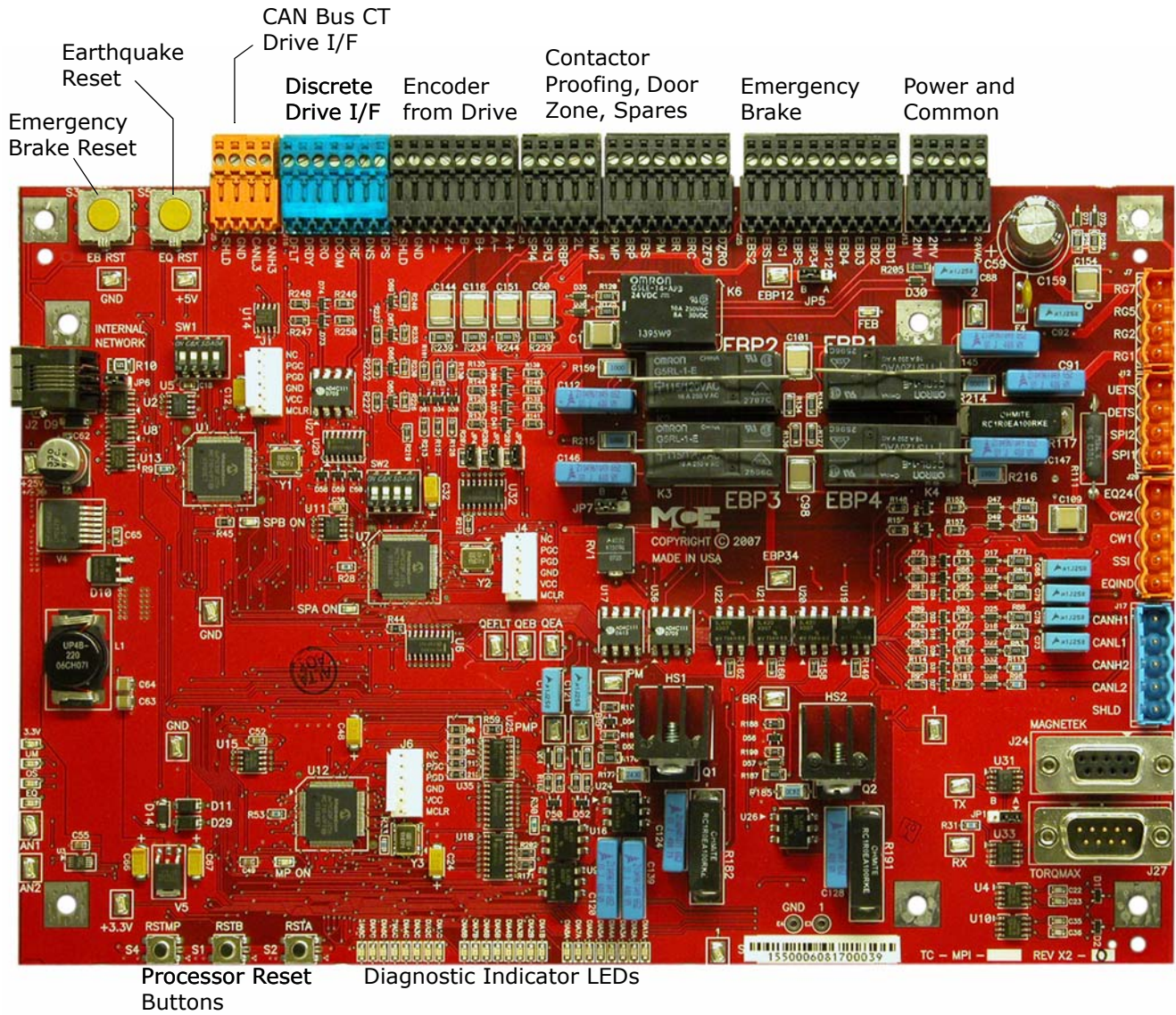

Table 5.25 TC-MPI Board Customer Connections

Connector	Pin	Label	Function
J5 CAN Bus Drive Control	1	CANH3	CT drive CAN interface CANH
	2	CANL3	CT drive CAN interface CANL
	3	GND	CT drive CAN interface Ground
	4	SHLD	CT drive CAN interface Shield connection
J7 Rope Gripper 240VAC Max	1	RG7	Control out
	2	RG5	Control in
	3	RG2	Analog Ground
	4	RG1	120VAC Out
J11 Buffered encoder sig- nal from drive to MPI board	1	A+	A+ buffered encoder from drive
	2	A-	A- buffered encoder from drive
	3	B+	B+ buffered encoder from drive
	4	B-	B- buffered encoder from drive
	5	Z+	Z+ buffered encoder from drive
	6	Z-	Z- buffered encoder from drive
	7	GND	Ground
	8	SHLD	Shield
J12 120VAC Max	1	UETS	Up Emergency Terminal Switch input (if used)
	2	DETS	Down Emergency Terminal Switch input (if used)
	3	SPI1	Spare Input 1 (assignable per job)
	4	SPI2	Spare Input 2 (assignable per job)
J16 Discrete Drive Control	1	DPS	AC Drive Positive, 16 - 14VDC
	2	DNS	AC Drive Negative, Ground
	3	DRE	Torqmax/Keb Drive Enable, Magnetek Drive Common
	4	DCOM	Torqmax/Keb A2.20 (16-18VDC), Magnetek Enable
	5	DRO	Drive On input
	6	DRDY	Drive Ready input
	7	DFLT	Drive Fault input
J20	1	EQ24	24V for counterweight "ring and string" movement detector
	2	CW2	Counterweight detector, 24VAC Max
	3	CW1	Counterweight detector, 24VAC Max
	4	SSI	Seismic Sensor Input, 24VAC Max
	5	EQIND	Earthquake Indicator, 120VAC Max

**Table 5.25 TC-MPI Board Customer Connections**

Connector	Pin	Label	Function
J17 CAN Bus Hoistway Position System Sensors	1	CANH1	CAN interface to first hoistway position sensor
	2	CANL1	CAN interface to first hoistway position sensor
	3	CANH2	CAN interface to second hoistway position sensor
	4	CANL2	CAN interface to second hoistway position sensor
	5	SHLD	CAN interface Shield connection
J24		MAGNETEK	9-Pin, D, serial control for Magnetek AC drive
J27		TORQMAX	9-Pin, D, serial control for (Keb) Torqmax drive
J2		INTERNAL NETWORK	CAN and power connections internal to Controller. Factory connection. Disconnection will reset board.

**Table 5.26 TC-MPI Board Jumpers**

Jumper	Function
JP1	Normal = A position: Terminating resistor for RS422/485 communication ON. B position: Removes terminating resistor from circuit.
JP2, JP3, JP4	Terminating resistors for buffered encoder information from drive. When jumpers are in place, terminating resistors are ON.
JP6	Terminating resistor for internal CAN Bus. When jumper is in place, terminating resistor is ON.
JP5, JP7	Normal = B position: RG monitoring done on TC-MPI board. A position: RG monitoring by equipment external to TC-MPI board.

**Table 5.27 TC-MPI Board MCE Internal Connections**

Connector	Pin	Label	Function
J3	1	PM2	Primary motor contactor
	2	2L	120VAC
	3	BRBP	Brake control
	4	SPI3	Spare Input (DNT1 if physical directional limits are used, F7 202)
	5	SPI4	Spare Input (UNT1 if physical directional limits are used, F7 202)
J9	1	DZRO	Door Zone Rear Output
	2	DZFO	Door Zone Front Output
	3	BRC	Brake Contactor Complimentary
	4	BR	Brake Contactor
	5	PM	Primary motor contactor
	6	FBS	Full Brake Strength, bypasses brake hold voltage resistor
	7	BRP	Brake Contactor
	8	PMP	Primary motor contactor



**Table 5.27 TC-MPI Board MCE Internal Connections**

Connector	Pin	Label	Function
J25	1	EBD1	Emergency Brake, 120VAC
	2	EBD2	Emergency Brake, 120VAC
	3	EBD3	Emergency Brake, 120VAC
	4	EBD4	Emergency Brake, 120VAC
	5	EBP12	Emergency Brake, monitoring
	6	EBP34	Emergency Brake, monitoring
	7	EBPS	Emergency Brake, Control
	8	RG1	120VAC
	9	EBS1	Emergency Brake, Control
	10	EBS2	Emergency Brake, Control
J13	1	24VAC	24V input
	2	1	Common
	3	1	Common
	4	2MV	120VAC input
	5	2MV	120VAC input

**Table 5.28 TC-MPI Board Switches**

Switch	Function
SW1	4-Position DIP switch. Board configuration. If replacing TC-MPI in the field, set exactly as original board.
SW2	4-Position DIP switch. Board configuration. If replacing TC-MPI in the field, set exactly as original board.
RSTMP, S4	Reset button for Motion Processor
RSTB, S1	Reset button for B Processor
RSTA, S2	Reset button for A Processor
EB RST, S3	Emergency Brake reset
EQ RST, S5	Earthquake reset

**Table 5.29 TC-MPI Board Diagnostic LEDs**

Indicator	Function
3.3V	Indicates presence of 3.3V power on board
UM	Lights if Unintended Motion fault is active
OS	Lights if Overspeed fault is active
EQ	Lights if Earthquake fault is active
DIA1A-DIA8C	Factory diagnostics only

## Motion Brake Module

A brake control module allows the level of the control voltage to be adjusted. Modulated voltages provide control over the entire range of brake movement. The module provides the ability to control the rate at which the brake descends onto the braking surface. With this ability, brake control can be more subtle resulting in a smoother ride under all motion conditions in which the brake plays a part, saving energy, and reducing brake coil temperatures.

The MCE brake module can be controlled by discrete inputs or through a CAN interface. Discrete control provides compatibility with MCE legacy controls. If a machine has dual independent brakes with one being used as an unintended motion emergency brake and the other as the standard machine brake, two modules are required.

Figure 5.14 Motion Brake Module

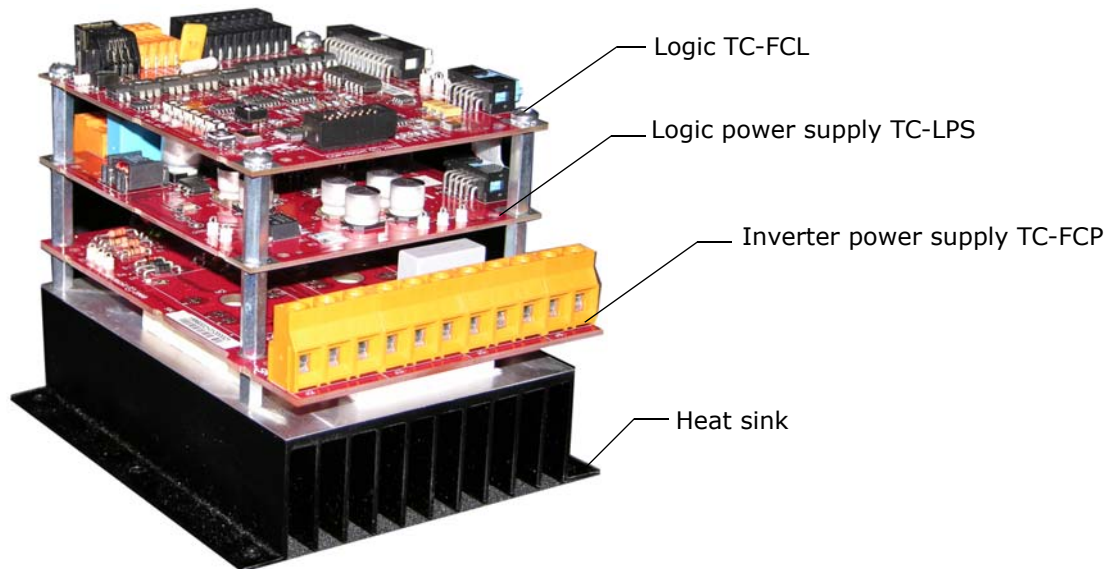

## Configuration

The top board, TC-FCL, provides the controls to configure the module for job requirements. Such configuration is completed at the factory when the module is shipped installed in a controller. If the module is a modification to an existing control, check this instruction for proper settings. If you are replacing an existing module, set up the new module to match.

Figure 5.15 Configuration

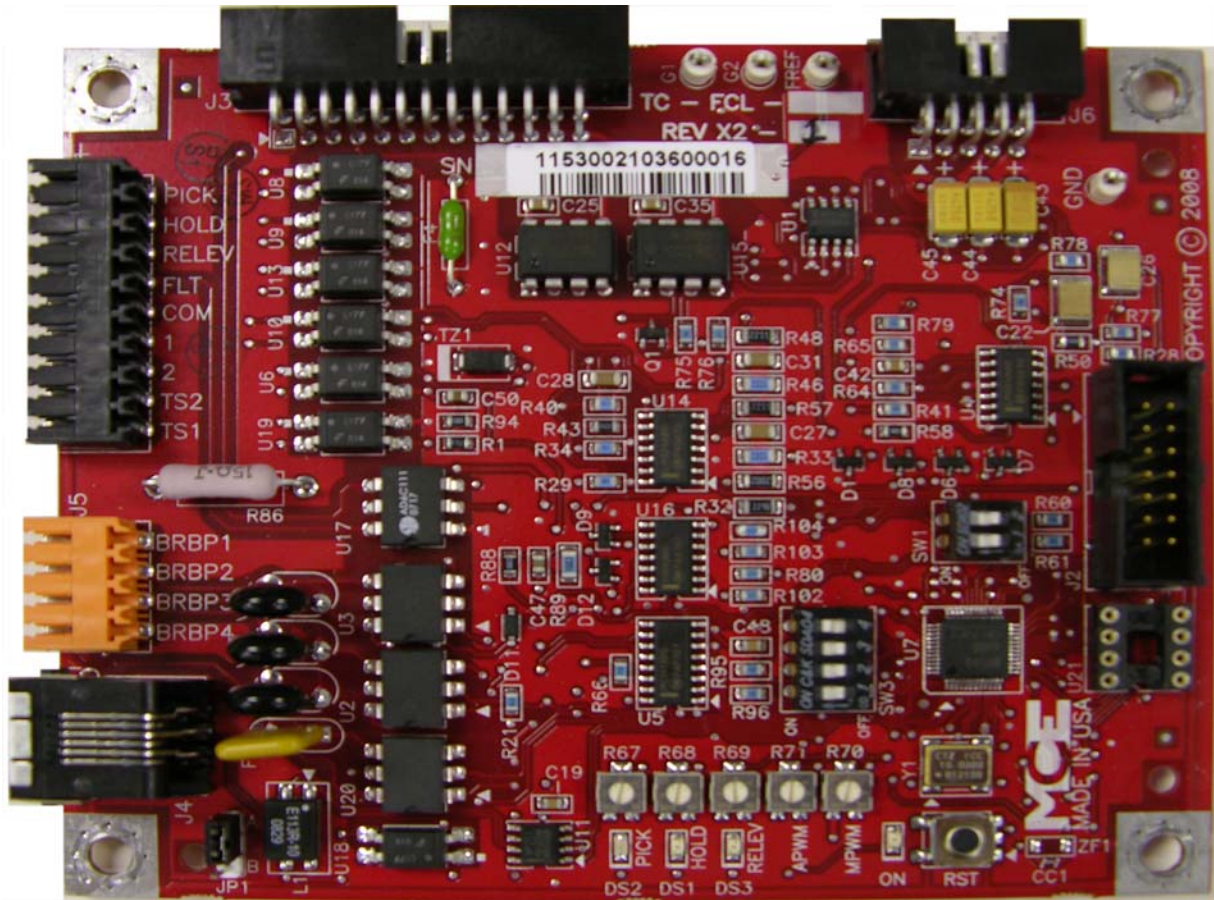

Switches and Jumpers

Table 5.30 SW1, Manual Bypass

2	1	Description
Off	Off	Manual brake pick enabled (will cause Main IGBT stuck open fault to be indicated until the brake contactor is picked to allow power to the brake module). In this mode, a manual brake pick switch connected between BRBP1 and BRBP3 will energize the brake coil connected between BRBP2 and BRBP4 and immediately lift the brake regardless of the status of the elevator controller.
Off	On	Unused
On	Off	Unused
On	On	Unused

The four switches of DIP switch SW3 function as two independent pairs. Switches 4 and 3 enable various software features. Switches 2 and 1 set the ID for the module. The ID identifies the module to the controller allowing it to be addressed and controlled independently of any other modules used (up to three).

**Table 5.31 SW3 Module ID and Software Features**

4	3	2	1	Description
		Off	Off	Brake module, ID=1 Primary brake module address
		Off	On	Brake module, ID=2 Secondary brake module address where module 1 controls the first brake coil and module 2 controls a second brake coil on the same machine.
		On	Off	Brake module, ID=3 Emergency brake module address
		On	On	Module, ID=4 Future
Off	Off			unused
Off	On			unused
On	Off			Enables software update from EEPROM chip inserted in socket U21
On	On			unused

**Reset Switch** The reset switch, RST, resets the logic board processor.

**Jumper JP1** JP1 enables/disables the CAN termination resistor.

- A position: Terminates the CAN connection on the board.
- B position: Leaves the CAN termination open on the board (Normal position for this board).

**ON LED**

The ON LED next to the Reset switch is on solidly when the module is powered and functioning properly. The ON LED will blink if a fault condition is detected. Under fault conditions, the LED will blink a number of times, go dark for a period of time, and then repeat. The number of blinks indicates the fault detected.

**Table 5.32 LED Fault Indication**

Blinks	Fault	Description	Reset
1	Load over current	If load current goes above 20A for more than 5 seconds, over current condition will be reported through FLT output and current will be limited to 20A.	Current reduction
2	Load over voltage	If load voltage goes above 310VDC for more than 5 seconds, over voltage condition will be reported through FLT output and voltage will be limited to 310V.	Voltage reduction
3	Aux IGBT stuck open	If the brake is in pick, hold, or relevel mode and the Aux IGBT monitoring circuit returns a high signal for 100mS or more, the Aux IGBT stuck closed fault will occur.	Discrete: Processor reset. CAN: Auto reset after 8 seconds.
4	Aux IGBT stuck closed	If the voltage across the Aux IGBT does not go high enough to trigger the Aux IGBT monitoring circuit during the dissipate mode, the Aux IGBT Stuck closed fault will occur. This fault is scanned for after the module switches from dissipate to inactive mode.	Discrete: Processor reset. CAN: Auto reset after 8 seconds.

**Table 5.32 LED Fault Indication**

Blinks	Fault	Description	Reset
5	Main IGBT stuck open	If the brake is in pick, hold, or relevel mode and there is less than 5 volts or 100mA across the coil for 200 mS or more, the IGBT stuck open fault will occur.	Discrete: Processor reset. CAN: Auto reset after 8 seconds.
6	Main IGBT stuck closed	If the brake is not in pick, hold, relevel, or dissipate mode and there is more than 10 volts or 2 Amps across the brake coil for 200 mS or more, the IGBT stuck closed fault will occur.	Discrete: Processor reset. CAN: Auto reset after 8 seconds.
7	Module overheat	The IGBT units on the bottom of the TC-FCP board generate heat when operating. A thermal sensor on the heat sink is connected to the module logic board through the TS1 and TS2 inputs. If the temperature becomes excessive, the logic module will generate a fault, pulling the FLT output to the Common connection level and alerting the controller.	Temperature reduction.
8	Trying to run in manual release mode	Manual brake pick is enabled.	Remove from manual brake pick mode.
9	Bypass button stuck closed	Brake bypass button stuck closed in manual pick mode.	Check button.
10	Not used		
<b>CAN MODE ONLY</b>			
11	Discrete input during CAN operation	Verify discrete pick, hold, and relevel inputs to J1 are not used when CAN control is active.	Auto reset after 8 seconds.
12	Module address error.	Verify SW1 positions for each module. <a href="#">5-78</a> .	Auto reset after 8 seconds.
13	Not calibrated	Module has not been calibrated	Calibrate module
14	Load undercurrent	Current <80% of learned	Auto reset after 8 seconds.
15	Load undervoltage	Voltage <80% of intended	Auto reset after seconds.
Continuously	CAN disconnected	CAN to module disconnected	Troubleshoot connection

**Module Connectors Per Board**

**Top Board, TC-FCL** This section provides information about user-accessible module connections.

**Table 5.33 J1 Pin Assignment**

Pin	Function
PICK	Discrete Pick control input from controller (V AC/DC)
HOLD	Discrete Hold control input from controller (V AC/DC)
RELEV	Discrete Relevel control input from controller (V AC/DC)
FLT	Overload fault output
COM	Common connection for PICK, HOLD, RELEV, FLT
1	1 Bus (common) from elevator controller
2	2 Bus (120VAC) from elevator controller

**Table 5.33 J1 Pin Assignment**

Pin	Function
TS2	Thermal switch input from sensor on module heat sink
TS1	Thermal switch input from sensor on module heat sink

**J4, J5** J4 is a modular, CAN connector for serial module control. (See preceding information about termination enabling jumper JP1.) J5 provides auxiliary connections that can be used to directly lift the machine brake, regardless of controller status.

**Table 5.34 J5 Auxiliary Brake Connections**

Pin	Function
BRBP1	With BRBP3, connects to auxiliary brake pick switch
BRBP2	With BRBP4, energizes brake coil when active
BRBP3	With BRBP1, connects to auxiliary brake pick switch
BRBP4	With BRBP2, energizes brake coil when active

The level of the pick voltage is adjusted using potentiometer R67. The maximum pick voltage range is determined by input voltage to the module and whether the input connection is single phase, FCL1/FCL2, or three phase, FCL1/FCL2/FCL3.

**J3** J3 provides control signals to the TC-FCP board and accepts feedback voltages from the TC-FCP board.

**J6** J6 accepts DC power voltages from the logic power supply board (TC-LPS).

**Middle Board, TC-LPS**

1 and 2 bus power connections from the controller are connected to TC-LPS connector J1. As viewed from the front of the connector, pinout is:

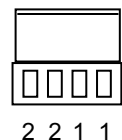

This board provides DC power to the logic board through connector J2.

**Bottom Board, TC-FCP**

The FCP board transforms AC input power (single or three phase) into the DC output voltage required to control the brake. The in-line connectors on the board are sized to handle higher voltage and current.

**Table 5.35 In-Line Connectors Pin Assignment**

Pin	Function
J2, SN1	With SN2, connection point for external filter provided with unit
J2, SN2	With SN1, connection point for external filter provided with unit
J2, SN3	With J3, SN4, connection point for user-provided external filter
J3, SN4	With J2, SN3, connection point for user-provided external filter
J3, FCO-	With FCO+, provides power to energize brake coil under normal logic conditions
J3, FCO+	With FCO-, provides power to energize brake coil under normal logic conditions
J5, DT1	Factory Only. Production testing.
J5, DT2	Factory Only. Production testing.

Table 5.35 In-Line Connectors Pin Assignment

Pin	Function
J5, FCL1	AC input, with J6, FCL2 for single-phase use or J6, FCL2/FCL3 for three-phase use
J6, FCL2	AC input, with J5, FCL1 for single-phase use or J5, FCL1/J6 FCL3 for three-phase use
J6, FCL3	AC input, with J5, FCL1 and J6, FCL2 for three-phase use.

Figure 5.16 External Filtering

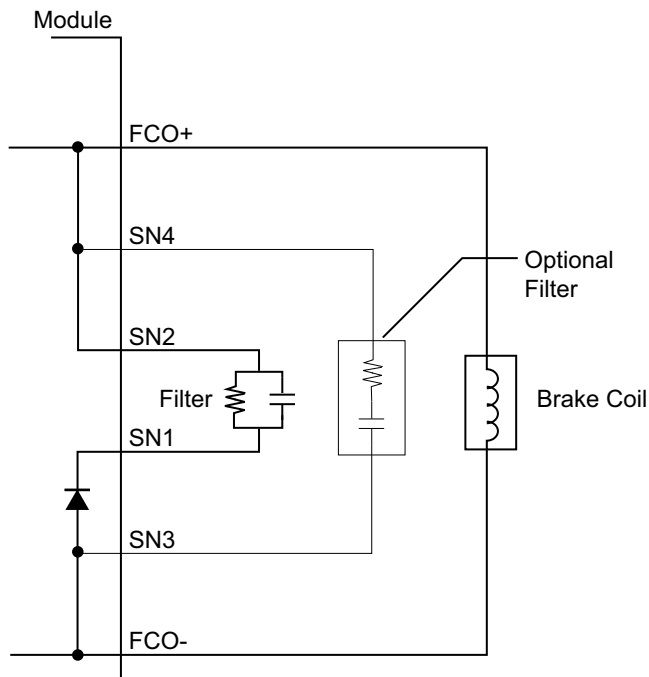
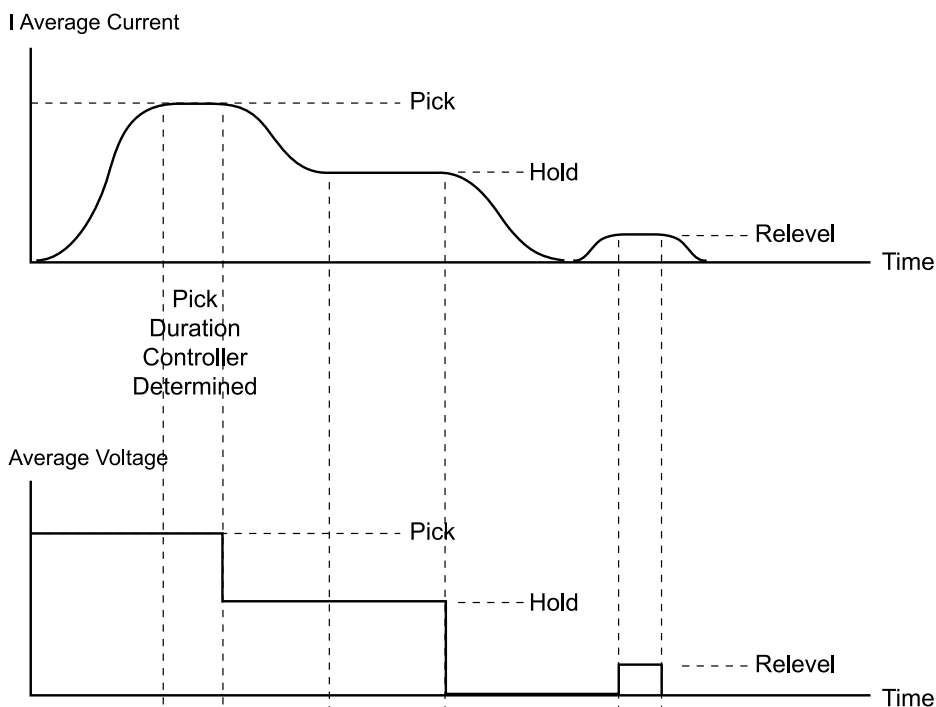

Figure 5.17 Brake Timing Diagram



### Calibration (CAN Only)

If CAN control is used, modules must be calibrated for Motion 4000 use through the F5 controller menu. Each module used, see “SW3 Module ID and Software Features” on page 5-78, must be calibrated.

1. On Machine Room Inspection, place the HC-MPU F5 function switch in the UP position.
2. Press N until the FCL BRAKE UNIT, UTILITIES MENU is displayed. Press S to select.
3. Press N to advance to FCL ADJUSTMENT MENU. Press S to select.
4. CALIBRATE FCL:1, [S]-SELECT will appear. Use +/- buttons to select appropriate module number. Press S to begin calibration.
5. PICK A DIRECTION TO CALIBRATE will be displayed. Press and hold either UP or DOWN direction. The display will show CALIBRATING FCL: STATUS: ...
6. Continue holding UP or DOWN direction until CALIBRATION DONE [N]-NEXT appears. If UP or DOWN is released too soon, the display will report CALIBRATE ABORT [N]-NEXT and the process must be repeated.
7. Repeat if additional modules must be calibrated.

### Trim pots and Function (Discrete Control Only)

Potentiometer settings are ignored when the module is being controlled through the TC-FCL, J4 CAN connection.

- R67, Brake Pick Voltage (maximum output to lift brake), LED lights
- R68, Brake Hold Voltage (percentage of Pick Voltage), LED lights
- R69, Brake Relevel Voltage (percentage of Pick Voltage), LED lights
- R70, Brake Drop Rate (clockwise = faster)
- R71, Brake Pick Rate (clockwise = faster)

### Setup for Adjustment

1. Disconnect power to the controller.
2. Discrete control only. Rotate trim pots R67, 68, and 69 counter-clockwise to locate the begin stop, then clockwise to locate the end stop. Then set to the approximate center position.
3. Connect Brake outputs FCO+/FCO- and BRBP2/BRBP4 (if used) as shown in your job drawings. These connections are probably made from the module to a panel-mount connector and from the panel-mount connector to the brake.
4. Connect the brake filter across SN1/SN2 as shown on the job prints. Connect the input 3- or single-phase power as shown in the job prints.
5. Connect control inputs from elevator controller as shown in your job prints (CAN or Discrete control).
6. Connect a volt meter across the brake coil.



**Discrete Control Adjustment**

Check that there is no CAN connection to the brake module. This procedure is for discrete volt-ages control.

1. Apply power to the controller. Place the elevator on Machine Room Inspection operation and pick a direction.
2. With the brake picked, adjust R67 to attain the brake manufacturer pick voltage. Verify that the brake picks cleanly.
3. After the brake settles to hold position, adjust R68 to attain manufacturer hold voltage. Verify that the brake is not dragging.
4. Disconnect power from the controller.
5. Disconnect the Relevel output from the module (place a wire nut on the wire end for safety). Move the Hold wire to the Relevel output.
6. Reconnect power to the controller.
7. On Inspection, pick direction and allow the brake to pick. The brake hold position is being controlled through the relevel output.
8. Adjust relevel R69 until the brake is just dragging but remains quiet.
9. Disconnect power from the controller. Return connections to their proper states.

**CAN Control Adjustment**

1. Apply power to the controller. Place the elevator on Machine Room Inspection.
2. Verify and/or set F7 brake parameters:

F7 #	Parameter	Description
133	Normal Brake Pick Delay	Time in milliseconds after drive enable command issued and acknowledged before the brake should pick.
134	Speed Pick Delay	Time in milliseconds after brake is picked before the speed command is issued. Used to prevent beginning movement under a slow-picking brake. Default 500.
135	Normal Brake Hold Delay	After take off, the brake is held fully picked until this timer expires, at which point, it settles to hold position/voltage. Geared machine default 2000. Gearless machine default 800.
136	Normal Brake Drop Delay	Delay in milliseconds that the brake should be delayed from dropping after the speed command is dropped. Goal is to avoid dropping the brake until the motor has just stopped moving. Default 250.
138	Drive Disable Delay	Time in milliseconds after stopping at a floor which the drive should maintain electrical control of the motor. May be used to compensate for a slow dropping brake. Default 1250.
139	Speed Hysteresis Delay	Provides a delay between when the speed command is issued and when it begins to accelerate the load.
185	Brake Type	Module 1, Module 2, or Discrete. Select as configured.

F7 #	Parameter	Description
186	Emergency Brake	Selects or disables the emergency brake option. Disabled = no emergency brake. Rope gripper = rope gripper. Sheave brake = sheave brake. Machine brake = independent machine brakes with one being used as the emergency brake.
190	Sheave Brake Idle Delay	Appears if sheave brake selected as emergency brake. When car is idle, sheave brake will drop after the time set here expires. Allows brake to be exercised. Time in seconds.
194	Normal Brake Pick Voltage	Set to pick voltage required by brake.
195	Normal Brake Hold Voltage	Set to hold voltage required by brake.
196	Normal Brake Relevel Voltage	Set to relevel voltage required by brake.
197	Normal Brake Lift Rate	Set desired lift rate in percentage. 100% = Fastest lift rate.
198	Normal Brake Drop Rate	Set desired drop rate in percentage. 100% = Fastest drop.
199	Emergency Brake Type	Module or Discrete voltages control.
200	Emergency Brake Pick Voltage	Only if Module selected in 199. Set required brake pick voltage.
201	Emergency Brake Hold Voltage	Only if Module selected in 199. Set required brake hold voltage.

3. Pick a run direction. Verify that the brake picks cleanly. If not, readjust pick voltage in F7 menu, save parameters, and retry.
4. After the brake settles to hold position, verify that the brake is not dragging. If necessary, readjust hold voltage in F7 menu, save parameters, and retry.
5. On Inspection, pick direction and verify brake-related F7 delay/time/rate are as desired. Upon dropping direction, verify brake-related F7 delay/time/rate are as desired. If necessary, readjust settings and retry.

**Only if a Manual Brake Pick Button is Used with CAN Control** If a manual brake pick button is used on this job (see “SW1, Manual Bypass” on page 5-77), pick voltage applied when the button is active is determined by FCL potentiometer R67. To adjust:

1. On Inspection, move the car to mid-point position in the hoistway to allow the car to safely drift up or down when the brake is picked. (Car must be appropriately counter-balanced to avoid rapid movement.)
2. Set SW3 to enable manual pick.
3. Press the manual pick button, observe brake pick while adjusting R67 to minimum required voltage for clean pick action.

Release the manual pick button. Take SW1 off manual pick mode.



**Motion Control Engineering®**

A Kinetek Company®

*Appendix*

---

## In this Section

This section contains:

- KEB F5 Parameter Table, [KEB F5 Parameters Table on page A-2](#)
- Magnetek Parameter Table, [Magnetek AC Drive Table on page A-6](#)
- Customer F7 Settings Log, [F7 Settings Record on page A-14](#)
- Customer General Settings Log, [General Settings Log on page A-21](#)
- Customer Notations, [General Settings Log on page A-21](#)
- Torqmax R6 Regen Drive Reference, [R6 Regenerative Drive Reference on page A-28](#)
- Floor setup after tape or TC-MPI replacement, [Manual Floor Setup on page A-29](#)

## KEB F5 Parameters Table

Enter the settings you make while adjusting into the Field column of the following table.

**Table A.1 TorqMax F5 Parameters for Motion 4000**

Display	Parameter Description	Unit	Range	Default	Field
<b>WARNING: Do not change drive parameters while the elevator is running. Incorrect drive parameter values can cause erratic operation.</b>					
<b>WARNING: Parameters with an asterisk (*) must be set correctly for your specific motor / machine / job. Refer to the adjustment manual for detailed information.</b>					
LF. 2	Signal operating mode: AbSPd - Absolute Analog Speed d SPd - Digital Speed Selection A tor - Analog Torque Control A Spd - Analog Speed Control SerSP - Serial Com. Speed Control bnSPd - Binary Speed Selection S POS - Serial Position feedback	-	AbSPd d Spd A tor A Spd SerSP BnSPd S POS	bnSPd	SerSP
LF. 3	Drive configuration: run- run mode conF - Configuration (5 minute time limit) Stop - Drive stopped, Motor cannot run. Drive will not respond. When using serial com, this mode allows parameter changes S Lrn - activate auto tune I Lrn - Inertia Learn. Learns the system inertia and activates the FFTC. P Lrn: Pole Learn. Learn the pole positions of PM Motor SPI - Stationary Pole Learn. Learn absolute encoder position for PM machine under brake without sheave movement. (N/A for software Version 1.61) OStST - Over speed test function. Allows car to over speed machine to test governor. (N/A for software Version 1.61)	-	run conF Stop S Lrn I Lrn P Lrn SPI OStST	conF	run
LF. 4	Motor-selection: Displays mode selected using US. 4 and US.10 ICLSd - Close loop induction I9LSS = Closed loop induction gearless PCLSd = Closed loop permanent magnet (PM) P9LSS = Closed loop PM gearless	-	see US.10	-	
LF. 5	Drive fault auto reset	1	0 - 10	5	
LF. 8	Electronic motor overload protection	-	on, off	off	
LF. 9	IM - Electronic overload current PM - not visible, auto set same as LF.12	A	1.0 - 110% Drive rated	8.0	
LF.10	IM - Rated motor power PM - read only, auto calc.	HP	0.00 - 125.00	5.00	
LF.11	Rated motor speed	rpm	10.0 - 6000.0	1165 or 150	
LF.12	Rated motor current	A	1.0 - 110% Drive rated	8.0	
LF.13	Rated motor frequency	Hz	4.0 - 100.0	60.0	

Table A.1 TorqMax F5 Parameters for Motion 4000

Display	Parameter Description	Unit	Range	Default	Field
LF.14	Rated motor voltage IM - Name plate rated voltage PM - No-load, phase-to-phase back EMF rms voltage at LF.11	V	IM: 120 - 500V PM: 1 - 32000V/krpm	230/460	
LF.15	IM: Power factor, PM: not visible	1	0.50 - 1.00	0.90	
LF.16	IM: Field weakening speed, PM: not visible	rpm	0.0 - 6000.0	set @ 80% of LF.11	
LF.17	Rated motor torque, IM - read only, auto calc. PM - enter motor name plate torque	lb ft	1 - 10000	IM - calc. PM - 18	
LF.18	PM: Motor stator resistance - from data sheet or learn procedure (see F5 Drive manual) IM: not visible	ohm	0.0 - 49.999	49.999	
LF.19	PM: Motor leakage inductance - from data sheet or learn procedure (see F5 Drive manual) IM: not visible	mH	0.01 - 500.00	1.00	
LF.20	Contract speed	fpm	0 - 1600	0	
LF.21	Traction sheave diameter (measured value)	inch	7.00 - 80.00	24.00	
LF.22	Gear reduction ratio	1	1.00 - 99.99	30.00	
LF.23	Roping ratio	1	1 - 8	1	
LF.24	Load weight	lbs	0 - 30000	0	
LF.25	Estimated gear ratio: Read only, auto calc.	0.01	1.00 - 99.99	-	
0.LF.26	Encoder Interface: displays feedback type	-	-	-	
LF.27	Encoder pulse number For InclE and SinCo reference to customer data For HIPER set to 1024 For EndAt set to 2048	ppr	256 - 16384	1024	
LF.28	Encoder channel swap / direction 0 nothing reversed 1 encoder A<B>B swapped 2 motor rotation reversed 3 motor rotation reversed, A<B>B swapped	1	0 - 3	0	
LF.29	Encoder sample time (recommend gearless = 4, geared = 8)	mSec	0.5 - 32	4	
LF.30	Control mode 0, 1 Open loop induction motor operation 2 - Closed loop speed control (LF. 2 = A Spd) 3 - Closed loop speed control with pre-torque 4 - Closed loop torque control (LF. 2 = A tor) 5 - Close loop speed control with synthesized pre-torque	1	0 - 5	0	
A.LF.31	Kp speed accel: Proportional gain, accel & run	1	1 - 50396	3000	
d.LF.31	Kp speed decel: Proportional gain, decel	1	1 - 50396	3000	
P.LF.31	Kp speed torque (Synth. Pre-torque)	1	1 - 50396	2000	
A.LF.32	Ki speed accel: Integral gain, accel & run	1	1 - 26214	350	
d.LF.32	Ki speed decel: Integral gain, decel	1	1 - 26214	250	
P.LF.32	KI speed torque (Synth. Pre-torque)	1	1 - 26214	10000	
A.LF.33	Ki speed offset accel: Gain at low speed, accel	1	0 - 8000	3000	
d.LF.33	Ki speed offset decel: Gain at low speed, decel	1	0 - 8000	1000	
0.LF.36	Maximum torque ( <b>Auto calc by the drive</b> ).	lb ft	0 - 500%Trtd	Calculated	
1.LF.36	Maximum torque emergency operation (=LF.17)	lb ft	0 - 500%Trtd	Calculated	

**Table A.1 TorqMax F5 Parameters for Motion 4000**

Display	Parameter Description	Unit	Range	Default	Field
LF.37	Open loop torque boost: Open loop op. only	%	0 - 25.5	5.0	
LF.38	Carrier frequency; 0 = 8 KHz, 1 = 16KHz (Note: set LF.38 = 0 if E.OL2 error on drive)	1	0, 1	0	
LF.41	Leveling speed (Not used, must set to 0)	fpm	0 - 25	0.0	
LF.42	High speed (Not used, must set to 0)	fpm	0.0 - LF.20	0.0	
LF.43	Inspection speed (Not used, must set to 0)	fpm	0.0 - 150.00	0.0	
LF.44	High leveling speed (Not used, must set to 0)	fpm	0.0 - LF.20	0.0	
LF.45	Earthquake Speed (Not used, must set to 0)	fpm	0.0 - 150.0	0.0	
LF.46	Emergency Pwr Speed (Not used, must set to 0)	fpm	0.0 - LF.20	0.0	
LF.47	Intermediate speed (Not used, must set to 0)	fpm	0.0 - LF.20	0.0	
LF.49	Over speed function Test (N/A for SW Version 1.61)	fpm	1- 2400	100	
0.LF.50	Profile 0 - Starting jerk (not used)	ft/s <sup>3</sup>			
0.LF.51	Profile 0 - Acceleration (not used)	ft/s <sup>2</sup>			
0.LF.52	Profile 0 - Acceleration jerk (not used)	ft/s <sup>3</sup>			
0.LF.53	Profile 0 - Deceleration jerk (not used)	ft/s <sup>3</sup>			
0.LF.54	Profile 0 - Deceleration (not used)	ft/s <sup>2</sup>			
0.LF.55	Profile 0 - Approach jerk (not used)	ft/s <sup>3</sup>			
1.LF.50	Profile 1 - Starting Jerk (not used)	ft/s <sup>3</sup>			
1.LF.51	Profile 1 - Acceleration (not used)	ft/s <sup>2</sup>			
1.LF.52	Profile 1 - Acceleration jerk (not used)	ft/s <sup>3</sup>			
1.LF.53	Profile 1 - Deceleration jerk (not used)	ft/s <sup>3</sup>			
1.LF.54	Profile 1 - Deceleration (not used)	ft/s <sup>2</sup>			
1.LF.55	Profile 1 - Approach jerk (not used)	ft/s <sup>3</sup>			
2.LF.50	Profile 2 - Starting jerk (not used)	ft/s <sup>3</sup>			
2.LF.51	Profile 2 - Acceleration (not used)	ft/s <sup>2</sup>			
2.LF.52	Profile 2 - Acceleration jerk (not used)	ft/s <sup>3</sup>			
2.LF.53	Profile 2 - Deceleration jerk (not used)	ft/s <sup>3</sup>			
2.LF.54	Profile 2 - Deceleration (not used)	ft/s <sup>2</sup>			
2.LF.55	Profile 2 - Approach jerk (not used)	ft/s <sup>3</sup>			
LF.56	Stop jerk (not used)	ft/s <sup>3</sup>			
LF.57	Speed following error (0 = off, 1 = on,)	1	off, on	1	
LF.58	Speed difference	%	0 - 30	10	
LF.59	Trigger time speed difference: Following error timer	sec	0.0 -1.0	1.0	
LF.61	Emergency operation mode. If using an MCE TAPS, (Traction Auxiliary Power Supply), this must be set to di1.		Off, SPd1, SPd2, SPd3, di1	off	
LF.67	Pre-torque gain	-	0.25 - 2.00	1.00	
LF.68	Pre-torque offset	%	-100.0 - 100.0	0.00	
LF.69	Pre-torque direction (0, 1 = +V, -1 = -V)	1	0, 1, -1	1	
LF.70	Speed pick delay (Delay to turn on DRO)	sec	0.0 - 3.0	0.30	
LF.71	Brake pick delay	sec	0.0 - 3.0	0.05	

Table A.1 TorqMax F5 Parameters for Motion 4000

Display	Parameter Description	Unit	Range	Default	Field
LF.76	Encoder resolution multiplier 2 for incremental encoder 8 for Sin/Cos, EnDat or Hiperface encoder	1	0 - 13	2	
LF.77	Absolute encoder position (measured)	1	0 - 65535h	0	
LF.78	Brake drop delay. Time motor will hold full current and control after direction inputs drop.	sec	0.00 - 3.00	0.50	
LF.79	Current hold time. Delay in turning off the drive (Delay to turn OFF the motor current after the direction is dropped and LF.78 has expired)	sec	0.00 - 3.00	0.30	
Diagnostic Parameters (Read only)					
LF.25	Estimated gear ratio	1			
LF.80	Software version	-			
LF.81	Software date	-			
LF.82	X2A input state	-	see tables in F5 Drive Manual		
LF.83	X2A output state	-			
LF.86	Operation mode	-			
LF.87	Actual inverter load (100% = rated load)	%			
LF.88	Motor command speed	rpm			
LF.89	Actual motor speed	rpm			
LF.90	Actual elevator speed	ft/m			
LF.93	Phase current	A			
LF.94	Peak phase current	A			
LF.95	Actual DC voltage	V			
LF.96	Peak DC voltage	V			
LF.97	Actual output frequency	Hz			
O.LF.98	Last error	-			
US Parameters					
US. 1	Password: With different passwords different parameter groups can be accessed for advanced programming.	-	-	-	
US. 3	Load defaults: Select LoAd and press ENTER to cause all LF parameters to be reset to drive default values.	-	LoAd	-	
US. 4	Load configuration: Select LoAd and press ENTER to load the configuration selected in US.10.	-	LoAd	-	
US.10	Select configuration: Selects the drive mode. ICLSd - Close loop induction I9LSS = Closed loop induction gearless PCLSd = Closed loop permanent magnet (PM) P9LSS = Closed loop PM gearless	-	ICLSd I9LSS PCLSd P9LSS	-	
US.34	Analog Pattern Gain	-	0.01-20.0	1.0	
US. 35	Reference Splitting: This function creates a slope between two successive serially transmitted speed values. This parameter should be adjusted for a time double the actual serial update rate of the speed command <b>Note:</b> Program to 40 msec for M4000 controller with Rev8	mSec	0 -200 mSec	0.0	

## Magnetek Parameters Table

Enter the settings you make while adjusting into the Field column of the following table.

**Table A.2 Magnetek AC Drive Table**

#	Operator Display	Parameter Description	Unit	Setting Range	MCE Defaults	Field Set
<b>Adjust A0</b>						
<b>A1</b>	<b>Drive</b>					
	Contract Car Spd	Elevator Contract Speed	fpm	0 - 3000	0.1	
	Contract Mtr Spd	Motor Speed at elevator contract speed	rpm	50 - 3000	1130	
	Response	Speed regulator sensitivity. If set too high, motor current and speed will be jittery. If too small, the motor will be sluggish.	rad/sec	1.0 - 20.0	10	
	Inertia	System inertia	sec	0.25 - 50.00	2.0	
	Inner Loop Xover	Inner speed loop crossover frequency (only with Ereg speed regulator)	rad/sec	0.1 - 20.0	2.0	
	Gain Reduce Mult	Speed regulator response percentage to use in low gain Mode. 100% = no reduction.	%	10 - 100	100	
	Gain Chng Level	Speed level to change to low gain mode (only with internal gain switch)	%	0 - 100.0	100	
	Tach Rate Gain	Compensates for rope resonance. Use only after A1, Inertia, and A1, Response, have been set correctly.	%	0 - 30.0	0	
	Spd Phase Margin	Phase margin of speed regulator (only with PI speed regulator)	o	45 - 90	80	
	Ramped Stop Time	Time to ramp from rated torque to zero (only with torque ramp down stop function)	sec	0 - 2.50	0.20	
	Contact Flt Time	Time before a contactor fault is declared	sec	0.10 - 5.00	0.50	
	Brake Pick Time	Time before a brake pick fault is declared	sec	0 - 5.00	0.00	
	Brake Hold Time	Time before a brake hold fault is declared	sec	0 - 5.00	0.00	
	Overspeed Level	Threshold for detection of overspeed fault	%	100.0 - 150.0	125.0	
	Overspeed Time	Time before an overspeed fault is declared	sec	0 - 9.99	1.00	
	Overspeed Mult	Multiplier for overspeed test (U4)	%	100 - 150	100	
	Encoder Pulses	Encoder counts per revolution	ppr	600 - 10000	1024	
	Spd Dev Lo Level	Range around the speed reference for speed deviation low logic output	%	00.1 - 10.0	10	
	Spd Dev Time	Time before speed deviation low logic output is true	sec	0 - 9.99	1.00	
	Spd DevHi Level	Level for declaring speed deviation alarm	%	0 - 99.9	20.0	
	Spd Command Bias	Subtracts an effective voltage to actual speed command voltage	volts	0 - 6.00	0.00	
	Spd Command Mult	Scales analog speed command	-	0.90 - 3.00	1.00	
	Pre Torque Bias	Subtracts an effective voltage to actual pre torque command voltage	volts	0 - 6.00	0.00	
	Pre Torque Mult	Scales pre-torque command	-	-10.00-10.00	1.00	
	Zero Speed Level	Threshold for zero speed logic output	%	0 - 99.99	1.00	
	Zero Speed Time	Time before zero speed logic output is declared true	sec	0 - 9.99	0.10	



Table A.2 Magnetek AC Drive Table

#	Operator Display	Parameter Description	Unit	Setting Range	MCE Defaults	Field Set
	Up/Dwn Threshold	Detection threshold, up or down direction	%	0 - 9.99	1.00	
	Mtr Torque Limit	Motoring torque limit. Torque Limit LED will light when this limit is reached.	%	0 - 250.0	250.0	
	Regen Torq Limit	Regenerating torque limit. Torque Limit LED will light when this limit is reached.	%	0 - 250.0	250.0	
	Flux Wkn Factor	Defines torque limit at higher speeds	%	60.0 - 100.0	75.0	
	Ana 1 Out Offset	Subtracts an effective voltage to actual analog output 1	%	-99.9 - 99.9	0.00	
	Ana 2 Out Offset	Subtracts an effective voltage to actual analog output 2	%	-99.9 - 99.9	0.00	
	Ana 1 Out Gain	Scaling factor for analog output 1	-	0 - 10.0	1.0	
	Ana 2 Out Gain	Scaling factor for analog output 2	-	0 - 10.0	1.0	
	Flt Reset Delay	Time Before a fault is automatically reset	sec	0 - 120	5	
	Flt Reset / Hour	Number of faults allowed to reset automatically per hour	fault	0 - 10	3	
	Up to SPD. Level	The logic output function is true when the motor speed is above the user specified speed defined here	%	0 - 110.00	080.00	
	Mains DIP Speed	When enabled by the Main DIP Speed (A1) parameter, speed is reduced by this percent when an undervoltage alarm is declared	%	5 - 99.9	25.00	
	Run Delay Timer	Delays drive recognition of RUN signal.	sec	0.00 - 0.99	0.00	
	AB Zero Spd Lev	Auto Brake Function - N/A to MCE products	%	0.00 - 2.00	0.00	
	AB Off Delay	N/A to MCE products	sec	0.00 - 9.99	0.00	
	Contactors DO Dly	N/A to MCE products	sec	0.00 - 5.00	0.00	
	TRQ Lim Msg Dly	Time duration drive is in torque limit before Hit Torque Limit message displayed.	sec	0.50 - 10.00	0.50	
	SER2 INSP SPD	Defines the serial mode 2 Inspection (only serial mode 2)	ft/ min	0 - 100	30	
	SER2 RS CRP SPD	Creep speed used in "rescue mode"	ft/ min	0 - 100	10	
	SER2 RS CPR Time	Maximum time drive will continue to run at rescue creep speed (only serial mode 2)	sec	0 - 200	180	
	SER2 FLT TOL	Maximum time that may elapse between valid run time messages before a serial fault is declared (only serial mode 2)	sec	0.0 - 2.0	0.04	
	Rollback Gain	Ant-rollback gain	-	1 - 99	1	
	Notch Filter Frq	Notch Filter Center Frequency	Hz	5 - 60	20	
	Notch Filt Depth	Notch filter maximum attenuation	%	0 - 100	0	
	MSPD Delay 1-4	Recognition time delay for a defined multistep speed command	sec	0.00 - 10.0	0.00	
<b>A2 S-Curves</b>						
	Accel Rate 0	Acceleration rate #0	ft/s <sup>2</sup>	0 - 7.99	3.00	
	Decel Rate 0	Deceleration rate #0	ft/s <sup>2</sup>	0 - 3.999	3.00	
	Accel Jerk in 0	Rate of increase of acceleration, up to ACCEL Rate, when increasing elevator speed	ft/s <sup>3</sup>	0 - 8.0	8.0	

Table A.2 Magnetek AC Drive Table

#	Operator Display	Parameter Description	Unit	Setting Range	MCE Defaults	Field Set
	Accel Jerk out 0	Rate of decrease of acceleration to zero when approaching contract elevator speed	ft/s <sup>3</sup>	0 - 8.0	8.0	
	Decel Jerk in 0	Rate of increase of deceleration, up to Decel Rate, when decreasing elevator speed	ft/s <sup>3</sup>	0 - 8.0	8.0	
	Decel Jerk out 0	Rate of decrease of deceleration to zero when slowing the elevator to leveling speed	ft/s <sup>3</sup>	0 - 8.0	8.0	
	Accel Rate 1	Acceleration rate #1	ft/s <sup>2</sup>	0 - 7.99	3.00	
	Decel Rate 1	Deceleration rate #1	ft/s <sup>2</sup>	0 - 7.99	3.00	
	Accel Jerk in 1	Rate of increase of acceleration, up to ACCEL Rate, when increasing elevator speed	ft/s <sup>3</sup>	0 - 8.0	8.0	
	Accel Jerk out 1	Rate of decrease of acceleration to zero when approaching contract elevator speed	ft/s <sup>3</sup>	0 - 8.0	8.0	
	Decel Jerk in 1	Rate of increase of deceleration, up to Decel Rate, when decreasing elevator speed	ft/s <sup>3</sup>	0 - 8.0	8.0	
	Decel Jerk out 1	Rate of decrease of deceleration to zero when slowing the elevator to leveling speed	ft/s <sup>3</sup>	0 - 8.0	8.0	
	Accel Rate 2	Acceleration rate #2	ft/s <sup>2</sup>	0 - 7.99	3.00	
	Decel Rate 2	Deceleration rate #2	ft/s <sup>2</sup>	0 - 7.99	3.00	
	Accel Jerk in 2	Rate of increase of acceleration, up to ACCEL Rate, when increasing elevator speed	ft/s <sup>3</sup>	0 - 8.0	8.0	
	Accel Jerk out 2	Rate of decrease of acceleration to zero when approaching contract elevator speed	ft/s <sup>3</sup>	0 - 8.0	8.0	
	Decel Jerk in 2	Rate of increase of deceleration, up to Decel Rate, when decreasing elevator speed	ft/s <sup>3</sup>	0 - 8.0	8.0	
	Decel Jerk out 2	Rate of decrease of deceleration to zero when slowing the elevator to leveling speed	ft/s <sup>3</sup>	0 - 8.0	8.0	
	Accel Rate 3	Acceleration rate #3	ft/s <sup>2</sup>	0 - 7.99	3.00	
	Decel Rate 3	Deceleration rate #3	ft/s <sup>2</sup>	0 - 7.99	3.00	
	Accel Jerk in 3	Rate of increase of acceleration, up to ACCEL Rate, when increasing elevator speed	ft/s <sup>3</sup>	0 - 8.0	8.0	
	Accel Jerk out 3	Rate of decrease of acceleration to zero when approaching contract elevator speed	ft/s <sup>3</sup>	0 - 8.0	8.0	
	Decel Jerk in 3	Rate of increase of deceleration, up to Decel Rate, when decreasing elevator speed	ft/s <sup>3</sup>	0 - 8.0	8.0	
	Decel Jerk out 3	Rate of decrease of deceleration to zero when slowing the elevator to leveling speed	ft/s <sup>3</sup>	0 - 8.0	8.0	
<b>A3 Multistep Ref</b>						
	Speed Command 1	Multi-Step Speed command #1	ft/m		0	
	Speed Command 2	Multi-Step Speed command #2	ft/m		0	
	Speed Command 3	Multi-Step Speed command #3	ft/m		0	
	Speed Command 4	Multi-Step Speed command #4	ft/m		0	
	Speed Command 5	Multi-Step Speed command #5	ft/m		0	
	Speed Command 6	Multi-Step Speed command #6	ft/m		0	
	Speed Command 7	Multi-Step Speed command #7	ft/m		0	
	Speed Command 8	Multi-Step Speed command #8	ft/m		0	

A

Table A.2 Magnetek AC Drive Table

#	Operator Display	Parameter Description	Unit	Setting Range	MCE Defaults	Field Set
	Speed Command 9	Multi-Step Speed command #9	ft/m		0	
	Speed Command 10	Multi-Step Speed command #10	ft/m		0	
	Speed Command 11	Multi-Step Speed command #11	ft/m		0	
	Speed Command 12	Multi-Step Speed command #12	ft/m		0	
	Speed Command 13	Multi-Step Speed command #13	ft/m		0	
	Speed Command 14	Multi-Step Speed command #14	ft/m		0	
	Speed Command 15	Multi-Step Speed command #15	ft/m		0	
<b>A4 Power Convert</b>						
	Id Reg Diff gain	Flux Current regulator differential gain	-	0.80 - 1.20	1.00	
	Id Reg Prop Gain	Flux current regulator proportional gain	-	0.20 - 0.40	0.30	
	Iq Reg Diff Gain	Torque current regulator differential gain	-	0.80 - 1.20	1.00	
	Iq Reg Prop Gain	Torque current regulator proportional gain	-	0.20 - 0.40	0.30	
	PWM Frequency	Carrier frequency	kHz	2.5 - 16.0	10.0	
	UV Alarm Level	Level for undervoltage alarm	%	80 - 99	80	
	UV Fault Level	Level for undervoltage fault	%	50 - 88	80	
	Extern Reactance	External choke reactance	%	0 - 10	0	
	Input L-L Volts	Nominal line-line AC input Voltage, RMS	volts	110 - 480	Drive dep.	
<b>A5 Motor</b>						
	Motor ID	Motor Identification	-	4 Pole DFLT, 6 Pole DFLT, MCE Test	MCE Test	
	Rated Mtr Power	Rated motor output power	HP	1.0 - 500	5.0	
	Rated Mtr Volts	Rated motor terminal RMS voltage	volts	190.0 - 575.0	460	
	Rated Excit Freq	Rated excitation frequency	Hz	5.0 - 400.0	60	
	Rated Motor Curr	Rated motor current	amps	1.00 - 800.00	6.8	
	Motor Poles	Motor poles	-	2 - 32	6	
	Rated Mtr Speed	Rated motor speed at full load	RPM	50.0 - 3000.0	1130	
	% No Load Curr	Percent no load current	%	10.0 - 60.0	45	
	Stator Leakage X	Stator leakage reactance	%	0 - 20.0	9.0	
	Rotor Leakage X	Rotor leakage reactance	%	0 - 20.0	9.0	
	Stator Resist	Stator resistance	%	0 - 20.0	1.5	
	Motor Iron Loss	Iron loss at rated frequency	%	0 - 15.0	0.5	
	Motor Mech Loss	Mechanical loss at rated frequency	%	0 - 15.0	1.0	
	Ovld Start Level	Maximum continuous motor current	%	100 - 150	110	
	Ovld Time Out	Time that defines motor overload curve	sec	5.0 - 120.0	60.0	
	Flux Sat Break	Flux saturation curve slope change point	%	0 - 100	75	
	Flux Sat Slope 1	Flux saturation curve slope for low fluxes	%	0 - 200.0	0	
	Flux Sat Slope 2	Flux saturation curve slope for high fluxes	%	0 - 200.0	50	

Table A.2 Magnetek AC Drive Table

#	Operator Display	Parameter Description	Unit	Setting Range	MCE Defaults	Field Set
<b>Configure C0</b>						
<b>C1</b>	<b>User Switches</b>					
	Spd Command Src	Speed Command Source	-	Analog input Multi-step Serial	Multi-step	Serial
	Run Command Src	Run Command Source	-	External TB Serial Serial+extern	External TB1	Serial
	Hi/Lo Gain Src	High / low gain change switch source	-	External TB 1 Serial Internal	Internal	
	Speed Reg Type	Chooses speed regulator	-	Elev spd reg Pi speed reg	Elev spd reg	
	Motor Rotation	Allows user to reverse direction of motor rotation	-	Forward Reverse	Forward	
	Spd Ref Release	Determines when speed reference release is asserted	-	Reg release Brake picked	Reg release	
	Cont Confirm Src	Enables external logic input for contactor confirmation.	-	None External TB	None	
	Pre Torque Source	Enables and determines the source of the pre torque command	-	None Analog input Serial	None	
	Pre Torque Latch	Determines if analog pre-torque command is latched	-	Not latched Latched	Not latched	
	PT torq Latch Clck	Determines source of pre torque latch control (if used)	-	External TB Serial	External tb	
	Fault Reset Src	Fault reset source	-	External TB Serial Automatic	External tb	
	Overspd Test Src	Determines external logic source to trigger overspeed test	-	External TB Serial	External tb	
	Brake Pick Src	If drive controls mechanical brake, determines source of brake pick command	-	Internal Serial	Internal	
	Brake Pick Cnfrm	Enables a logic input to use for brake pick confirmation	-	None External TB	None	
	Brake Hold Src	If drive controls mechanical brake, determines source of brake hold command	-	Internal Serial	Internal	
	Ramped Stop Sel	Selects normal stop or torque ramp down stop	-	None Ramp on stop	None	
	Ramp Down En Src	Determines the source that signals the torque ramp down stop (if used)	-	External TB Run logic Serial	External tb	
	Brk Pick Flt Ena	Brake pick fault enable	-	Enable Disable	Disable	
	Brk Hold Flt Ena	Brake hold fault enable	-	Enable Disable	Disable	
	Ext Torq Cmd Src	When Speed Reg Type = External Reg, sets the source of the torque command	-	None Serial	None	

Table A.2 Magnetek AC Drive Table

#	Operator Display	Parameter Description	Unit	Setting Range	MCE Defaults	Field Set
	Dir Confirm	Confirms proper analog signal polarity when enabled and a logic input is programmed to Run Up and Run Down	-	Enabled Disabled	Disabled	
	S-Curve Abort	Addresses how the S-Curve Speed Reference Generator handles a reduction in the speed command before the S-Curve Generator has reached its target speed.	-	Enabled Disabled	Disabled	
	Fast Flux	Reduces starting takeoff time by reducing motor fluxing time	-	Enabled Disabled	Enabled	
	Main DIP Ena	Enables the Mains DIP Speed (A1) parameter that reduces speed when an undervoltage alarm is declared	-	Enabled Disabled	Disabled	
	DB Protection	Dynamic braking Protection fault or alarm selection		Fault Alarm	Fault	
	Encoder Fault	Temporarily disables the Encoder Fault	-	Enabled Disabled	Enabled	
	Stopping Mode	Determines stopping mode when Spd Command Src = multi-step	-	Immediate Ramp to stop	Immediate	
	Motor Ovrd Sel	Motor Overload Selection	-	Alarm Flt Immediate Fault at Stop	Alarm	
	Auto Stop	Auto Stop Function enable	-	Disable Enable	Disable	
	Serial Mode	Serial Protocol selection	-	Mode 1 Mode 2 Mode 2 test	Mode 1	
	SER2 FLT Mode	Defines reaction to a serial communication fault while in Serial Mode 2 (Only serial mode 2)	-	immediate	Immediate Run remove rescue	
	DRV Fast Disable	Addresses how fast the drive responds to the removal of Drive Enable logic input.	-	Disable	Disable Enable	
	MLT-SPD to DLY1	Assigns multi-step speed command to recognition delay timer 1	-	None	None mspd1- mspd15	
	MLT-SPD to DLY2	Assigns multi-step speed command to recognition delay timer 1	-	None	None mspd1- mspd15	
	MLT-SPD to DLY3	Assigns multi-step speed command to recognition delay timer 1	-	None	None mspd1- mspd15	
	MLT-SPD to DLY4	Assigns multi-step speed command to recognition delay timer 1	-	None	None mspd1- mspd15	
<b>C2</b>	<b>Logic Inputs</b>					
	Log In 1 TB1-1	Terminal 1 Selection	-	-	DRIVE ENABLE	
	Log In 2 TB1-2	Terminal 2 Selection	-	-	RUN UP	

Table A.2 Magnetek AC Drive Table

#	Operator Display	Parameter Description	Unit	Setting Range	MCE Defaults	Field Set
	Log In 3 TB1-3	Terminal 3 Selection	-	-	RUN DOWN	
	Log In 4 TB1-4	Terminal 4 Selection	-	-	FAULT RESET	NO FUNCTION
	Log In 5 TB1-5	Terminal 5 Selection	-	-	STEP REF B0	NO FUNCTION
	Log In 6 TB1-6	Terminal 6 Selection	-	-	STEP REF B1	NO FUNCTION
	Log In 7 TB1-7	Terminal 7 Selection	-	-	STEP REF B2	NO FUNCTION
	Log In 8 TB1-8	Terminal 8 Selection	-	-	STEP REF B3	NO FUNCTION
	Log In 9 TB1-9	Terminal 9 Selection	-	-	S-CURVE SEL 0	NO FUNCTION
<b>C3</b>	<b>Logic Outputs</b>					
	Log Out 1 tb1-14	Terminal 14 Selection	-	-	SPEED DEV LOW	NO FUNCTION
	Log Out 2 tb1-15	Terminal 15 Selection	-	-	RUN COMMAND	NO FUNCTION
	Log Out 3 tb1-16	Terminal 16 Selection	-	-	MTR OVERLOAD	NO FUNCTION
	Log Out 4 tb1-17	Terminal 17 Selection	-	-	ENCODER FAULT	NO FUNCTION
	Relay Coil 1	Relay 1 Function Selection	-	-	FAULT	
	Relay Coil 2	Relay 2 Function Selection	-	-	SPEED REG RLS	
<b>C4</b>	<b>Analog Outputs</b>					
	Ana Out 1 tb1-33	Terminal 33 Selection	-	-	SPEED CMD	
	Ana Out 2 tb1-35	Terminal 35 Selection	-	-	SPEED FEEDBK	
Utility U0						
<b>U1</b>	<b>Password</b>	Password	-	-	000000	
<b>U2</b>	<b>Hidden Items</b>	Enable or disable hidden parameters Enable                                      Disable	-	-	ENABLE	
<b>U3</b>	<b>Unit</b>	Unit for parameters English                                      Metric	-	-	ENGLISH	

Table A.2 Magnetek AC Drive Table

#	Operator Display	Parameter Description	Unit	Setting Range	MCE Defaults	Field Set
U4	Overspeed Test	Allows overspeed test during inspection Yes No	-	-	No	
U5	Restore Dflts	Reset all parameters to default values				
U6	Drive Info	Drive information: _____ Drive Version: _____ Boot Version: _____ Cube ID: _____ Drive Type: _____				
U7	HEX Monitor	Hex Monitor				

A

## F7 Settings Record

Please use the following table to record your F7 menu settings. If the TC-MPI board is replaced in the future, this will provide you a quick way to re-enter proper settings. Also, if you place a support call to MCE, these values are information you will need to speed problems solving.)

**Table A.3 F7 Parameter Log**

ID#	Description	Setting
1	Floor 1 (bottom floor served)	
2	Floor 2 (next floor ascending)	
3-64	Floors in ascending order	
65	Bottom Access Distance: Distance in Inches from bottom floor to virtual bottom access up-travel limit switch position.	
66	Top Access Distance: Distance in Inches from top floor to virtual top access down-travel limit switch position.	
67	Counterweight Position: Distance in Inches above the bottom floor at which the counterweight is adjacent to the car. Learned through F6 menu. May be adjusted here.	
68	Directional Limit Distance: Distance in Inches at which the virtual direction limit switches are positioned beyond the terminal floor level positions.	
69	U/DETS Option: If up and down emergency terminal switches are positioned in software by the system, they are Virtual. If mechanical switches are installed, they are Physical. If emergency terminal switches are not used, select Unused.	
70	U/DNT1 Option: If up and down position 1 normal terminal switches are positioned in software by the system, they are Virtual. If mechanical switches are installed, they are Physical. If position 1 normal terminal switches are not used, select Unused.	
71	U/DNT2 Option: If up and down position 2 normal terminal switches are positioned in software by the system, they are Virtual. If mechanical switches are installed, they are Physical. If position 2 normal terminal switches are not used, select Unused.	
72	U/DNT3 Option: If up and down position 3 normal terminal switches are positioned in software by the system, they are Virtual. If mechanical switches are installed, they are Physical. If position 3 normal terminal switches are not used, select Unused.	



**Table A.3 F7 Parameter Log**

ID#	Description	Setting
73	U/DNT4 Option: If up and down position 4 normal terminal switches are positioned in software by the system, they are Virtual. If mechanical switches are installed, they are Physical. If position 4 normal terminal switches are not used, select Unused.	
74	U/DNT5 Option: If up and down position 5 normal terminal switches are positioned in software by the system, they are Virtual. If mechanical switches are installed, they are Physical. If position 5 normal terminal switches are not used, select Unused.	
75	UETS Speed: Speed in feet per minute which the car must be below when tripping the up emergency terminal switch. Must never be in excess of 95% of contract speed. Determined by contract speed and position of the switch.	
76	UETS Distance: Distance in Inches from the top terminal floor level position at which the up emergency terminal switch is positioned. Approximately half the distance needed by the drive to decelerate to zero speed from contract speed.	
77	UETS Delta Distance: Distance in Inches on either side of the up emergency terminal switch position inside which the car must detect the up emergency terminal switch. If not, the car will perform an emergency stop.	
78	UETS Delta Speed: Delta speed is generally unused in applications below 400 FPM. Delta Speed provides an "adder" to UETS speed. UETS speed and Delta speed together may not exceed 95% of contract speed. If you are tripping an ETS fault during car setup, you can choose to use this adder or you can choose to temporarily disable the ETS switches by setting them to Unused until you have sufficient control of the car.	
79	UNTS1 Speed: Speed in feet per minute which the car must be below when tripping the UNTS1 switch.	
80	UNTS1 Distance: Distance in inches from the top terminal floor level position at which a virtual UNTS1 switch is positioned.	
81	UNTS1 Delta Distance: Distance in inches on either side of the UNTS1 switch inside which the car must detect the switch. If not, the car will perform an emergency slow down.	

**Table A.3 F7 Parameter Log**

ID#	Description	Setting
82	UNTS1 Delta Low Speed: Along with the Delta High Speed setting, determines a speed range which the car must be within to avoid causing an emergency slow down.	
83	UNTS1 Delta High Speed: Along with the Delta Low Speed setting, determines a speed range which the car must be within to avoid causing an emergency slow down.	
84	UNTS2 Speed (See UNTS1)	
85	UNTS2 Distance (See UNTS1)	
86	UNTS2 Delta Distance (See UNTS1)	
87	UNTS2 Delta Low Speed (See UNTS1)	
88	UNTS2 Delta High Speed (See UNTS1)	
89	UNTS3 Speed (See UNTS1)	
90	UNTS3 Distance (See UNTS1)	
91	UNTS3 Delta Distance (See UNTS1)	
92	UNTS3 Delta Low Speed (See UNTS1)	
93	UNTS3 Delta High Speed (See UNTS1)	
94	UNTS4 Speed (See UNTS1)	
95	UNTS4 Distance (See UNTS1)	
96	UNTS4 Delta Distance (See UNTS1)	
97	UNTS4 Delta Low Speed (See UNTS1)	
98	UNTS4 Delta High Speed (See UNTS1)	
99	UNTS5 Speed (See UNTS1)	
100	UNTS5 Distance (See UNTS1)	
101	UNTS5 Delta Distance (See UNTS1)	
102	UNTS5 Delta Low Speed (See UNTS1)	
103	UNTS5 Delta High Speed (See UNTS1)	
104	DETS Speed: Speed in feet per minute which the car must be below when tripping the down emergency terminal switch. Must never be in excess of 95% of contract speed. Determined by contract speed and position of the switch.	
105	DETS Distance: Distance in Inches from the bottom terminal floor level position at which the down emergency terminal switch is positioned. Approximately half the distance needed by the drive to decelerate to zero speed from contract speed.	

Table A.3 F7 Parameter Log

ID#	Description	Setting
106	DETS Delta Distance: Distance in Inches on either side of the down emergency terminal switch position inside which the car must detect the down emergency terminal switch. If not, the car will perform an emergency stop.	
107	DETS Delta Speed: Delta speed is generally unused in applications below 400 FPM. Delta Speed provides an "adder" to DETS speed. DETS speed and Delta speed together may not exceed 95% of contract speed. If you are tripping an ETS fault during car setup, you can choose to use this adder or you can choose to temporarily disable the ETS switches by setting them to Unused until you have sufficient control of the car.	
108	DNTS1 Speed: Speed in feet per minute which the car must be below when tripping the DNTS1 switch.	
109	DNTS1 Distance: Distance in inches from the bottom terminal floor level position at which a virtual DNTS1 switch is positioned.	
110	DNTS1 Delta Distance: Distance in inches on either side of the DNTS1 switch inside which the car must detect the switch. If not, the car will perform an emergency slow down.	
111	DNTS1 Delta Low Speed: Along with the Delta High Speed setting, determines a speed range which the car must be within to avoid causing an emergency slow down.	
112	DNTS1 Delta High Speed: Along with the Delta Low Speed setting, determines a speed range which the car must be within to avoid causing an emergency slow down.	
113	DNTS2 Speed (See DNTS1)	
114	DNTS2 Distance (See DNTS1)	
115	DNTS2 Delta Distance (See DNTS1)	
116	DNTS2 Delta Low Speed (See DNTS1)	
117	DNTS2 Delta High Speed (See DNTS1)	
118	DNTS3 Speed (See DNTS1)	
119	DNTS3 Distance (See DNTS1)	
120	DNTS3 Delta Distance (See DNTS1)	
121	DNTS3 Delta Low Speed (See DNTS1)	
122	DNTS3 Delta High Speed (See DNTS1)	
123	DNTS4 Speed (See DNTS1)	
124	DNTS4 Distance (See DNTS1)	
125	DNTS4 Delta Distance (See DNTS1)	

**Table A.3 F7 Parameter Log**

ID#	Description	Setting
126	DNTS4 Delta Low Speed (See DNTS1)	
127	DNTS4 Delta High Speed (See DNTS1)	
128	DNTS5 Speed (See DNTS1)	
129	DNTS5 Distance (See DNTS1)	
130	DNTS5 Delta Distance (See DNTS1)	
131	DNTS5 Delta Low Speed (See DNTS1)	
132	DNTS5 Delta High Speed (See DNTS1)	
133	Brake Pick Delay: Time in milliseconds after the drive enable command is issued before the brake should pick.	
134	Speed pick delay: The time in milliseconds after the brake is picked before the speed command is issued.	
135	Brake Hold Delay: After take off, the brake is held fully picked until this timer expires, at which point it settles to hold position/voltage.	
136	Brake Drop Delay: Delay in milliseconds that the brake should be delayed from dropping after the speed command is dropped.	
138	Drive disable Delay: The time in milliseconds after stopping at a floor which the drive should maintain electrical control of the motor.	
139	Speed hysteresis Delay: Provides a delay between when the speed command is issued and when it begins to accelerate the load.	
140	Profile Advance: Advances application of the curve but with no speed command issued.	
141	Profile Scale: Scales the curve to affect all associated speed settings. i.e., 50% of Standard pattern would reduce Contract and other associated speeds to 50% of their value.	
142	Standard Slew Slope: Increases/Decreases the steepness of the acceleration and deceleration ramps for the standard curve.	
143	Danger Slew Slope: Increases/Decreases the steepness of the deceleration ramp for the danger curve.	
144	Slew Filter: Smooths the slew slope of acceleration or deceleration, mitigating the sensation of jerkiness or uneven acceleration/deceleration.	
145	Contract Overspeed: Setting in feet per minute above contract speed at which a contract overspeed is detected.	

**Table A.3 F7 Parameter Log**

ID#	Description	Setting
146	Inspection Overspeed: Setting in feet per minute above inspection speed at which an inspection overspeed is detected and an emergency stop initiated.	
147	Leveling Overspeed: Setting in feet per minute above leveling speed at which a leveling overspeed is detected and an emergency stop initiated.	
148	Hoist-motor Speed: Setting in drive sheave RPM at which the car achieves contract speed.	
149	Contract Speed: Contract speed of the car in feet per minute.	
150	High Speed: High speed limit for the Standard curve. Usually the same as Contract Speed.	
151	Intermediate Speed	
152	Earthquake Speed	
153	Auxiliary Speed	
154	Backup power speed	
155	Inspection Speed (Normal)	
156	Inspection Speed (Reduced)	
157	Correction Speed	
158	Leveling Speed	
159	Releveling Speed	
160	Leveling Distance	
161	Releveling distance	
162	Proximity distance	
165	Standard Start Jerk	
166	Standard Roll Jerk	
167	Standard Stop Jerk	
168	Standard Acceleration	
169	Standard Deceleration	
170	Manual Start Jerk	
171	Manual Roll Jerk	
172	Manual Stop Jerk	
173	Manual Acceleration	
174	Manual Deceleration	
175	Danger Start Jerk	
176	Danger Roll Jerk	
177	Danger Stop Jerk	
178	Danger Deceleration	
179	Alternate Start Jerk	

**Table A.3 F7 Parameter Log**

ID#	Description	Setting
180	Alternate Roll Jerk	
181	Alternate Stop Jerk	
182	Alternate Acceleration	
183	Alternate Deceleration	
184	Drive Type: Select the drive used in the controller.	
185	Brake Type Option	
186	Emergency Brake Option	
187	Reduced Inspect Speed	
188	Unintended Motion	
189	Following error	
190	Sheave Brake Idle Delay	
191	Landing System	
192	Speed Drop Delay: Magnetek drives only. Time in milliseconds during which the drive should continue to exert motor control after the car has achieved the floor and before the brake has dropped.	
193	Profile Compensation: Dynamic: Variable, controller determined compensation for drive lag based on entry in parameter 140, Profile Advance. Fixed: Fixed compensation for drive lag using the parameter 140, Profile Advance setting.	
194	Normal Brake Pick Voltage	
195	Normal Brake Hold Voltage	
196	Normal Brake Relevel Voltage	
197	Normal Brake Lift Rate	
198	Normal Brake Drop Rate	
199	Emergency Brake Type	
200	Emergency Brake Pick Voltage	
201	Emergency Brake Hold Voltage	
202	Directional Limit Type	

A

# General Settings Log

Program Mode (F1) Parameter Settings Record		
OPTIONS	CURRENT VALUES	NEW VALUES
<b>BASIC FEATURES</b>		
Controller Type:	<input type="checkbox"/> Hydro (M2000) <input type="checkbox"/> Traction (M4000)	<input type="checkbox"/> Hydro (M2000) <input type="checkbox"/> Traction (M4000)
Simplex / Local or Duplex?	<input type="checkbox"/> Simplex <input type="checkbox"/> Local <input type="checkbox"/> Duplex	<input type="checkbox"/> Simplex <input type="checkbox"/> Local <input type="checkbox"/> Duplex
Operation:	<input type="checkbox"/> Sel. Coll. <input type="checkbox"/> Single Button <input type="checkbox"/> Single Auto PB	<input type="checkbox"/> Sel. Coll. <input type="checkbox"/> Single Button <input type="checkbox"/> Single Auto PB
Top Landing Served (This car)?		
HC-RDR Board on this Car (This car)	<input type="checkbox"/> Yes <input type="checkbox"/> No	<input type="checkbox"/> Yes <input type="checkbox"/> No
Car Serves Frnt/Flr (This car)?	1 2 3 4 5 6 7 8 10 11 12 13 14 15 16 17 18 19 20 21 22 23 24 25 26 27 28 29 30 31 32	1 2 3 4 5 6 7 8 10 11 12 13 14 15 16 17 18 19 20 21 22 23 24 25 26 27 28 29 30 31 32
Car Serves Rear/Flr (This car)?	1 2 3 4 5 6 7 8 10 11 12 13 14 15 16 17 18 19 20 21 22 23 24 25 26 27 28 29 30 31 32	1 2 3 4 5 6 7 8 10 11 12 13 14 15 16 17 18 19 20 21 22 23 24 25 26 27 28 29 30 31 32
Top Landing Served (Other car)?		
HC-RDR Board on this Car (Other car)	<input type="checkbox"/> Yes <input type="checkbox"/> No	<input type="checkbox"/> Yes <input type="checkbox"/> No
Other Car Serves Frnt/Flr?	1 2 3 4 5 6 7 8 10 11 12 13 14 15 16 17 18 19 20 21 22 23 24 25 26 27 28 29 30 31 32	1 2 3 4 5 6 7 8 10 11 12 13 14 15 16 17 18 19 20 21 22 23 24 25 26 27 28 29 30 31 32
Other Car Serves Rear/Flr?	1 2 3 4 5 6 7 8 10 11 12 13 14 15 16 17 18 19 20 21 22 23 24 25 26 27 28 29 30 31 32	1 2 3 4 5 6 7 8 10 11 12 13 14 15 16 17 18 19 20 21 22 23 24 25 26 27 28 29 30 31 32
Parking Floor		
Alt. Parking Floor		
Secondary Park Floor		
Lobby Floor		
Car Identifier	Set first car to A, next car to B, etc.	Set first car to A, next car to B, etc.
Serial COP Board HC-CPI?	<input type="checkbox"/> Yes <input type="checkbox"/> No	<input type="checkbox"/> Yes <input type="checkbox"/> No
Discrete PIs on UIO?	<input type="checkbox"/> Yes <input type="checkbox"/> No	<input type="checkbox"/> Yes <input type="checkbox"/> No
Dedicated PI Board?	<input type="checkbox"/> Yes <input type="checkbox"/> No	<input type="checkbox"/> Yes <input type="checkbox"/> No
Serial Cartop Door CNTRL?	<input type="checkbox"/> Yes <input type="checkbox"/> No	<input type="checkbox"/> Yes <input type="checkbox"/> No
Disable Local Hall Calls?	<input type="checkbox"/> Yes <input type="checkbox"/> No	<input type="checkbox"/> Yes <input type="checkbox"/> No
<b>FIRE SERVICE</b>		
Fire Service Operation?	<input type="checkbox"/> Yes <input type="checkbox"/> No	<input type="checkbox"/> Yes <input type="checkbox"/> No
Fire Phase 1 Main Floor		
Fire Phase 1 Alt. Floor		
Fire Service Code		
Fire Phase 1, 2 <sup>nd</sup> Alt Landing		
Will This Car Run on PH2?	<input type="checkbox"/> Yes <input type="checkbox"/> No	<input type="checkbox"/> Yes <input type="checkbox"/> No
Bypass Stop Sw. on Phase 1?	<input type="checkbox"/> Yes <input type="checkbox"/> No	<input type="checkbox"/> Yes <input type="checkbox"/> No
Honeywell Fire Operation?	<input type="checkbox"/> Yes <input type="checkbox"/> No	<input type="checkbox"/> Yes <input type="checkbox"/> No
NYC Fire Phase 2 w/ ANSI 89?	<input type="checkbox"/> Yes <input type="checkbox"/> No	<input type="checkbox"/> Yes <input type="checkbox"/> No
White Plains, NY Fire Code?	<input type="checkbox"/> Yes <input type="checkbox"/> No	<input type="checkbox"/> Yes <input type="checkbox"/> No
Mass 524 CMR Fire Code?	<input type="checkbox"/> Yes <input type="checkbox"/> No	<input type="checkbox"/> Yes <input type="checkbox"/> No
ASME A17.1A 200x Addenda?	<input type="checkbox"/> None <input type="checkbox"/> 2005 <input type="checkbox"/> 2007	<input type="checkbox"/> None <input type="checkbox"/> 2005 <input type="checkbox"/> 2007
Disable DPM on Fire PH.2?	<input type="checkbox"/> Yes <input type="checkbox"/> No	<input type="checkbox"/> Yes <input type="checkbox"/> No
Low Voltage Fire Sensor?	<input type="checkbox"/> Yes <input type="checkbox"/> No	<input type="checkbox"/> Yes <input type="checkbox"/> No
Latch Flashing Fire Hat?	<input type="checkbox"/> Yes <input type="checkbox"/> No	<input type="checkbox"/> Yes <input type="checkbox"/> No
<b>DOOR OPERATION</b>		
Nudging?	<input type="checkbox"/> Yes <input type="checkbox"/> No	<input type="checkbox"/> Yes <input type="checkbox"/> No
Stuck Photo Eye Protection?	<input type="checkbox"/> Yes <input type="checkbox"/> No	<input type="checkbox"/> Yes <input type="checkbox"/> No
Sequential Door Oper.(F/R)?	<input type="checkbox"/> Yes <input type="checkbox"/> No	<input type="checkbox"/> Yes <input type="checkbox"/> No
Car Call Cancels Door Time?	<input type="checkbox"/> Yes <input type="checkbox"/> No	<input type="checkbox"/> Yes <input type="checkbox"/> No
Nudging During Fire Phase 1?	<input type="checkbox"/> Yes <input type="checkbox"/> No	<input type="checkbox"/> Yes <input type="checkbox"/> No
Retiring Cam Option?	<input type="checkbox"/> Yes <input type="checkbox"/> No	<input type="checkbox"/> Yes <input type="checkbox"/> No
Pre-Opening?	<input type="checkbox"/> Yes <input type="checkbox"/> No	<input type="checkbox"/> Yes <input type="checkbox"/> No
Mechanical Safety Edge?	<input type="checkbox"/> Yes <input type="checkbox"/> No	<input type="checkbox"/> Yes <input type="checkbox"/> No
Nudging Output/Buzzer Only?	<input type="checkbox"/> Yes <input type="checkbox"/> No	<input type="checkbox"/> Yes <input type="checkbox"/> No

**Program Mode (F1) Parameter Settings Record**

OPTIONS	CURRENT VALUES	NEW VALUES
D.C.B. Cancels Door Time?	___ Yes ___ No	___ Yes ___ No
Leave Door Open on MGS (Traction only)	___ Yes ___ No	___ Yes ___ No
Leave Door Open on PTI/ESS?	___ Yes ___ No	___ Yes ___ No
Nudging During Fire Phase 2?	___ Yes ___ No	___ Yes ___ No
Dir. Preference Until DLK?	___ Yes ___ No	___ Yes ___ No
Fully Manual Doors?	___ Yes ___ No	___ Yes ___ No
Cont. D.C.B. to Close Doors?	___ Yes ___ No	___ Yes ___ No
Cont. D.C.B. for Fire Phase 1?	___ Yes ___ No	___ Yes ___ No
Moment. D.O.B. door opening? Moment D.O.B. for: Moment D.O.B. for:	___ No ___ Front ___ Rear ___ Both Doors ___ Hall Calls ___ Car Calls ___ All Calls	___ No ___ Front ___ Rear ___ Both Doors ___ Hall Calls ___ Car Calls ___ All Calls
Doors to open if parked?	___ None ___ Front ___ Rear ___ Both	___ None ___ Front ___ Rear ___ Both
Doors to Open on Main Fire?	___ Front ___ Rear ___ Both	___ Front ___ Rear ___ Both
Doors to Open on Alt. Fire?	___ Front ___ Rear ___ Both	___ Front ___ Rear ___ Both
Leave Doors Open on CTL	___ Yes ___ No	___ Yes ___ No
Limited Door Re-Open Option	___ Yes ___ No	___ Yes ___ No
Reduce HCT with Photo Eye	___ Yes ___ No	___ Yes ___ No
Leave Doors Open on EPI	___ Yes ___ No	___ Yes ___ No
Doors to open if No demand?	___ None ___ Front ___ Rear ___ Both	___ None ___ Front ___ Rear ___ Both
Const. Press Op. Bypass PHE?	___ Yes ___ No	___ Yes ___ No
Door Type is?	___ Horizontal ___ Vertical	___ Horizontal ___ Vertical
Front Door Mech. Coupled?	___ Yes ___ No	___ Yes ___ No
Rear Door Mech. Coupled?	___ Yes ___ No	___ Yes ___ No
Prevent DCP Till Doors Close:	___ Yes ___ No	___ Yes ___ No
Moment D.C.B to Close Doors?	___ Yes ___ No	___ Yes ___ No
Doors to Latch DOF?	___ None ___ Front ___ Rear ___ Both	___ None ___ Front ___ Rear ___ Both
Doors to Latch DCF?	___ None ___ Front ___ Rear ___ Both	___ None ___ Front ___ Rear ___ Both
Inv. Door Close Limit?	___ None ___ Front ___ Rear ___ Both	___ None ___ Front ___ Rear ___ Both
Fire PH2 with Doors Closed?	___ Yes ___ No	___ Yes ___ No
<b>TIMER</b>		
Short Door Timer	___ seconds	___ seconds
Car Call Door Timer	___ seconds	___ seconds
Hall Call Door Timer	___ seconds	___ seconds
Lobby Door Timer	___ seconds	___ seconds
Nudging Timer	___ seconds	___ seconds
Time out of Service Timer	___ None ___ seconds	___ None ___ seconds
Motor Limit Timer	___ None ___ minutes	___ None ___ minutes
MGR Output Timer (Traction only)	___ minutes	___ minutes
Door Hold Input Timer	___ seconds	___ seconds
Parking Delay Timer	___ minutes	___ minutes
Fan/Light Output Timer	___ minutes	___ minutes
Hospital Emerg. Timer	___ minutes	___ minutes
Door Open Protection Timer	___ seconds	___ seconds
CTL Door Open Timer	___ seconds	___ seconds
Door Buzzer Timer	___ seconds	___ seconds
Opn/Cls Intrlock Timer	___ milliseconds	___ milliseconds
Fire PH1 Reclose Timer?	___ Yes ___ No	___ Yes ___ No
<b>GONGS/LANTERNS</b>		
Mounted in hall or car?	___ Hall ___ Car	___ Hall ___ Car
Double strike on Down?	___ Yes ___ No	___ Yes ___ No
PFG Enable Button?	___ Yes ___ No	___ Yes ___ No
Main Egress Floor		
Egress Floor Arrival Gong?	___ No Main Egress Floor = ___	___ No Main Egress Floor = ___
Car lantern Door Fully Open?	___ Yes ___ No	___ Yes ___ No



A

Program Mode (F1) Parameter Settings Record		
OPTIONS	CURRENT VALUES	NEW VALUES
<b>SPARE INPUTS</b>		
SPIN1 on HC-CTL used for:		
SPIN2 on HC-CTL used for:		
SPIN3 on HC-CTL used for:		
SPIN4 on HC-CTL used for:		
SPIN5 on HC-CTL used for:		
SPIN6 on HC-CTL used for:		
SPIN7 on HC-CTL used for:		
SPIN8 on HC-CTL used for:		
SPIN9 on HC-CTL used for:		
SPIN10 on HC-CTL used for:		
IO 1, UIO 32 used for:		
IO 2, UIO 32 used for:		
IO 3, UIO 32 used for:		
IO 4, UIO 32 used for:		
IO 5, UIO 32 used for:		
IO 6, UIO 32 used for:		
IO 7, UIO 32 used for:		
IO 8, UIO 32 used for:		
IO 1, UIO 33 used for:		
IO 2, UIO 33 used for:		
IO 3, UIO 33 used for:		
IO 4, UIO 33 used for:		
IO 5, UIO 33 used for:		
IO 6, UIO 33 used for:		
IO 7, UIO 33 used for:		
IO 8, UIO 33 used for:		
IO 1, UIO 34 used for:		
IO 2, UIO 34 used for:		
IO 3, UIO 34 used for:		
IO 4, UIO 34 used for:		
IO 5, UIO 34 used for:		
IO 6, UIO 34 used for:		
IO 7, UIO 34 used for:		
IO 8, UIO 34 used for:		
IO 1, UIO 35 used for:		
IO 2, UIO 35 used for:		
IO 3, UIO 35 used for:		
IO 4, UIO 35 used for:		
IO 5, UIO 35 used for:		
IO 6, UIO 35 used for:		
IO 7, UIO 35 used for:		
IO 8, UIO 35 used for:		
IO 1, UIO 36 used for:		
IO 2, UIO 36 used for:		
IO 3, UIO 36 used for:		
IO 4, UIO 36 used for:		
IO 5, UIO 36 used for:		
IO 6, UIO 36 used for:		
IO 7, UIO 36 used for:		
IO 8, UIO 36 used for:		
CPI F I10		
CPI F I11		
CPI F I12		

Program Mode (F1) Parameter Settings Record		
OPTIONS	CURRENT VALUES	NEW VALUES
CPI F I13		
CPI F I14		
CPI F I15		
CPI F I16		
CPI R I10		
CPI R I11		
CPI R I12		
CPI R I13		
CPI R I14		
CPI R I15		
CPI R I16		
CPI X I1		
CPI X I2		
CPI X I3		
CPI X I4		
CPI X I5		
CPI X I6		
CPI X I7		
SPARE OUTPUTS		
SPOUT1 used for:		
SPOUT2 used for:		
SPOUT3 used for:		
SPOUT4 used for:		
IO 9, UIO 32 used for:		
IO 10, UIO 32 used for:		
IO 11, UIO 32 used for:		
IO 12, UIO 32 used for:		
IO 13, UIO 32 used for:		
IO 14, UIO 32 used for:		
IO 15, UIO 32 used for:		
IO 16, UIO 32 used for:		
IO 9, UIO 33 used for:		
IO 10, UIO 33 used for:		
IO 11, UIO 33 used for:		
IO 12, UIO 33 used for:		
IO 13, UIO 33 used for:		
IO 14, UIO 33 used for:		
IO 15, UIO 33 used for:		
IO 16, UIO 33 used for:		
IO 9, UIO 34 used for:		
IO 10, UIO 34 used for:		
IO 11, UIO 34 used for:		
IO 12, UIO 34 used for:		
IO 13, UIO 34 used for:		
IO 14, UIO 34 used for:		
IO 15, UIO 34 used for:		
IO 16, UIO 34 used for:		
IO 9, UIO 35 used for:		
IO 10, UIO 35 used for:		
IO 11, UIO 35 used for:		
IO 12, UIO 35 used for:		
IO 13, UIO 35 used for:		
IO 14, UIO 35 used for:		
IO 15, UIO 35 used for:		

A

Program Mode (F1) Parameter Settings Record		
OPTIONS	CURRENT VALUES	NEW VALUES
<b>SPARE OUTPUTS</b>		
IO 16, UIO 35 used for:		
IO 9, UIO 36 used for:		
IO 10, UIO 36 used for:		
IO 11, UIO 36 used for:		
IO 12, UIO 36 used for:		
IO 13, UIO 36 used for:		
IO 14, UIO 36 used for:		
IO 15, UIO 36 used for:		
IO 16, UIO 36 used for:		
CPI F O10		
CPI F O11		
CPI F O12		
CPI F O13		
CPI F O14		
CPI F O15		
CPI F O16		
CPI R O10		
CPI R O11		
CPI R O12		
CPI R O13		
CPI R O14		
CPI R O15		
CPI R O16		
CPI X O1		
CPI X O2		
CPI X O3		
CPI X O4		
CPI X O5		
CPI X O6		
CPI X O7		
<b>EXTRA FEATURES</b>		
PI Output Type:	<input type="checkbox"/> 1 wire <input type="checkbox"/> Binary 0 <input type="checkbox"/> Binary 1	<input type="checkbox"/> 1 wire <input type="checkbox"/> Binary 0 <input type="checkbox"/> Binary 1
Emergency Power Return Floor		
Emergency Power Operation?	<input type="checkbox"/> No Emergency Power Return Floor = <input type="checkbox"/>	<input type="checkbox"/> No Emergency Power Return Floor = <input type="checkbox"/>
Consec Stops w/o PHE Limit?		
Light Load Weighing?	<input type="checkbox"/> No Light Load Car Call Limit = <input type="checkbox"/>	<input type="checkbox"/> No Light Load Car Call Limit = <input type="checkbox"/>
Photo Eye Anti-Nuisance?	<input type="checkbox"/> No Consec Stops w/o PHE Limit = <input type="checkbox"/>	<input type="checkbox"/> No Consec Stops w/o PHE Limit = <input type="checkbox"/>
Earthquake Operation	<input type="checkbox"/> ANSI Eq Op <input type="checkbox"/> California Eq Op	<input type="checkbox"/> ANSI Eq Op <input type="checkbox"/> California Eq Op
MG Shutdown Operation (Traction only)	<input type="checkbox"/> MGS Return Landing	<input type="checkbox"/> MGS Return Landing
CC Card Reader Security?	<input type="checkbox"/> Yes <input type="checkbox"/> No	<input type="checkbox"/> Yes <input type="checkbox"/> No
WPJA Landing?	<input type="checkbox"/> <input type="checkbox"/>	<input type="checkbox"/> <input type="checkbox"/>
WPJB Landing?	<input type="checkbox"/> <input type="checkbox"/>	<input type="checkbox"/> <input type="checkbox"/>
WPJC Landing?	<input type="checkbox"/> <input type="checkbox"/>	<input type="checkbox"/> <input type="checkbox"/>
WPJD Landing?	<input type="checkbox"/> <input type="checkbox"/>	<input type="checkbox"/> <input type="checkbox"/>
WPJE Landing?	<input type="checkbox"/> <input type="checkbox"/>	<input type="checkbox"/> <input type="checkbox"/>
WPJF Landing?	<input type="checkbox"/> <input type="checkbox"/>	<input type="checkbox"/> <input type="checkbox"/>
WPJG Landing?	<input type="checkbox"/> <input type="checkbox"/>	<input type="checkbox"/> <input type="checkbox"/>
WPJH Landing?	<input type="checkbox"/> <input type="checkbox"/>	<input type="checkbox"/> <input type="checkbox"/>
Allow Car Calls on WP Sec?	<input type="checkbox"/> Yes <input type="checkbox"/> No	<input type="checkbox"/> Yes <input type="checkbox"/> No
Retain Calls On CTL/CTF?	<input type="checkbox"/> Yes <input type="checkbox"/> No	<input type="checkbox"/> Yes <input type="checkbox"/> No
Cancel Both Hall (U/D) Calls?	<input type="checkbox"/> Yes <input type="checkbox"/> No	<input type="checkbox"/> Yes <input type="checkbox"/> No
Automatic Floor Stop Option?	<input type="checkbox"/> No Floor # for Car to Stop at: <input type="checkbox"/>	<input type="checkbox"/> No Floor # for Car to Stop at: <input type="checkbox"/>
Car Call Cancel w/Dir. Reversal?	<input type="checkbox"/> Yes <input type="checkbox"/> No	<input type="checkbox"/> Yes <input type="checkbox"/> No

**Program Mode (F1) Parameter Settings Record**

OPTIONS	CURRENT VALUES	NEW VALUES
Cancel Car Calls Behind Car?	___ Yes ___ No	___ Yes ___ No
CE Electronics Board?	___ Rev 1 ___ Rev 2	___ Rev 1 ___ Rev 2
EMS Service Floor		
Massachusetts EMS Service?	___ No EMS Service Floor #: ___	___ No EMS Service Floor #: ___
Master Software Key	___ Activated ___ Deactivated ___ Enabled	___ Activated ___ Deactivated ___ Enabled
PI Turned off if No Demand?	___ Yes ___ No	___ Yes ___ No
Hospital Emerg. Operation (This car)	___ Yes ___ No	___ Yes ___ No
Hospital Calls Frnt/Flr (This car)?	1 2 3 4 5 6 7 8 10 11 12 13 14 15 16 17 18 19 20 21 22 23 24 25 26 27 28 29 30 31 32	1 2 3 4 5 6 7 8 10 11 12 13 14 15 16 17 18 19 20 21 22 23 24 25 26 27 28 29 30 31 32
Hospital Calls Rear/Flr (This car)?	1 2 3 4 5 6 7 8 10 11 12 13 14 15 16 17 18 19 20 21 22 23 24 25 26 27 28 29 30 31 32	1 2 3 4 5 6 7 8 10 11 12 13 14 15 16 17 18 19 20 21 22 23 24 25 26 27 28 29 30 31 32
Hospital Emerg. Operation (Other car)	___ Yes ___ No	___ Yes ___ No
Other Car Hospital Calls Frnt/Flr?	1 2 3 4 5 6 7 8 10 11 12 13 14 15 16 17 18 19 20 21 22 23 24 25 26 27 28 29 30 31 32	1 2 3 4 5 6 7 8 10 11 12 13 14 15 16 17 18 19 20 21 22 23 24 25 26 27 28 29 30 31 32
Other Car Hospital Calls Rear/Flr?	1 2 3 4 5 6 7 8 10 11 12 13 14 15 16 17 18 19 20 21 22 23 24 25 26 27 28 29 30 31 32	1 2 3 4 5 6 7 8 10 11 12 13 14 15 16 17 18 19 20 21 22 23 24 25 26 27 28 29 30 31 32
Fire Bypasses Hospital?	___ Yes ___ No	___ Yes ___ No
High Speed Delay After Run?	___ Yes ___ No	___ Yes ___ No
Single Speed AC Option? (Traction only)	___ Yes ___ No	___ Yes ___ No
Sabbath Operation?	___ Yes ___ No	___ Yes ___ No
Sabbath Up Calls Front Floor?	1 2 3 4 5 6 7 8 10 11 12 13 14 15 16 17 18 19 20 21 22 23 24 25 26 27 28 29 30 31	1 2 3 4 5 6 7 8 10 11 12 13 14 15 16 17 18 19 20 21 22 23 24 25 26 27 28 29 30 31
Sabbath Up Calls Rear Floor?	1 2 3 4 5 6 7 8 10 11 12 13 14 15 16 17 18 19 20 21 22 23 24 25 26 27 28 29 30 31	1 2 3 4 5 6 7 8 10 11 12 13 14 15 16 17 18 19 20 21 22 23 24 25 26 27 28 29 30 31
Sabbath Down Calls Front Floor?	2 3 4 5 6 7 8 10 11 12 13 14 15 16 17 18 19 20 21 22 23 24 25 26 27 28 29 30 31 32	2 3 4 5 6 7 8 10 11 12 13 14 15 16 17 18 19 20 21 22 23 24 25 26 27 28 29 30 31 32
Sabbath Down Calls Rear Floor?	2 3 4 5 6 7 8 10 11 12 13 14 15 16 17 18 19 20 21 22 23 24 25 26 27 28 29 30 31 32	2 3 4 5 6 7 8 10 11 12 13 14 15 16 17 18 19 20 21 22 23 24 25 26 27 28 29 30 31 32
Intermediate Speed between Floors?	2 3 4 5 6 7 8 10 11 12 13 14 15 16 17 18 19 20 21 22 23 24 25 26 27 28 29 30 31 32	2 3 4 5 6 7 8 10 11 12 13 14 15 16 17 18 19 20 21 22 23 24 25 26 27 28 29 30 31 32
Leveling Sensors	___ Enabled ___ Disabled	___ Enabled ___ Disabled
KCE	___ Enabled ___ Disabled	___ Enabled ___ Disabled
Analog Load Weigher?	___ None ___ MCE ___ K-Tech	___ None ___ MCE ___ K-Tech
Ind. Bypass Security?	___ Yes ___ No	___ Yes ___ No
Ats. Bypass Security?	___ Yes ___ No	___ Yes ___ No
Car to Floor Return Floor	___ Floor	___ Floor
Scrolling Speed	___ Slow ___ Normal ___ Fast	___ Slow ___ Normal ___ Fast
OFRP Between Flrs	___ Floor ___ Floor	___ Floor ___ Floor
Earthquake Operation?	___ Yes ___ No	___ Yes ___ No
Enable Front DOB on Security?	___ Yes ___ No	___ Yes ___ No
Enable Rear DOB on Security?	___ Yes ___ No	___ Yes ___ No
Flr Count Below Flood Level?	___	___
Disable Top Flrs on PITFLD?	___ Yes ___ No	___ Yes ___ No
<b>ADDITIONAL CAR OPTIONS (Traction only)</b>		
ETS Switches Required?	___ Yes ___ No	___ Yes ___ No
Hoistway Access?	___ Yes ___ No	___ Yes ___ No
Door Position Monitor	___ None ___ Front ___ Rear ___ Both	___ None ___ Front ___ Rear ___ Both
Front Door Close Limit?	___ None ___ DCL ___ GS+DCAB	___ None ___ DCL ___ GS+DCAB
Rear Door Close Limit?	___ None ___ DCL ___ GS+DCAB	___ None ___ DCL ___ GS+DCAB
Motion 2000/4000 Version 00.08.0047		



## R6 Regenerative Drive Reference

This section includes quick reference information for the PowerBack R6 Regenerative AC drive. Please refer to the R6 Regenerative drive manual provided with the product for detailed explanation of the parameters.

**Table A.5 Quick Reference for PowerBack R6 Regenerative Drive**

Display	Parameter Description	Setting Range	Resolution	Field/MCE Setting
<b>WARNING: Do not change drive parameters while the elevator is running. Incorrect values can cause erratic elevator operation.</b>				
CP. 0	Password input	0...9999	1	---
CP. 1	Status display	---	---	---
CP. 2	Main Line Frequency	---	0.1 Hz	---
CP. 3	AC-Phase current L1	---	0.1 A	---
CP. 4	AC-Phase current L2	---	0.1 A	---
CP. 5	AC-Phase current L3	---	0.1 A	---
CP. 6	Actual Load	---	1%	---
CP. 7	Actual Load / peak value	---	1%	---
CP. 8	DC output current	---	0.1 A	---
CP. 9	Actual DC voltage	---	1 V	---
CP.10	DC voltage / peak value	---	1 V	---
CP.11	Heat sink temperature	---	1 °C	---
CP.12	Overload counter	---	1%	---
CP.13	Active power	---	0.1kW	---
CP.14	Total regen kWhr counter	---	0.1 kWh	---
CP.15	Total motor kWhr counter	---	0.1 kWh	---
CP.16	Total net kWhr counter	---	0.1 kWh	---
CP.17	Apparent power / Line input	---	0.1 kVA	---
CP.18	Analog output 1 / amplification factor	-20.00...20.00	0.01	1.00
CP.19	DC bus switching level	+/- 30000.00	0.01	Set to 260 for 208 - 240Vac Set to 600 for 460 - 480Vac
CP.20	Auto error reset counter	0...10	1	3
CP.21	Last Error	---	---	---
CP.22	Last Error 1	---	---	---
CP.23	Last Error 2	---	---	---
CP.24	Last Error 3	---	---	---
CP.25	Last Error 4	---	---	---
CP.26	Last Error 5	---	---	---
CP.27	Last Error 6	---	---	---
CP.28	Last Error 7	---	---	---
CP.29	Software version	---	---	1.3
CP.30	Software date code	DDMM.Y	---	---
CP.31	Power part ID code	---	---	250
CP.32*	Pulse off Level	-100kW...0.0kW	0.1kW	-0.8kW
CP.33*	Operating Mode	0...3	1	0
CP.34*	Control Angle	0.0...60.0	0.1	29.0

## Manual Floor Setup

All data modified through the controller F7 menu is stored on the TC-MPI board. This data includes the floor heights associated with the unique values on the ELGO tape. Each tape has unique value encoding. A value near the bottom of the tape provides the zero height reference setting at the first floor for the controller. For example, a tape value of 253,451 mm may be the zero inches reference for a first floor height. All numbers above or below are referenced to that value. If the TC-MPI board or ELGO tape is replaced the floor data must be re-learned or re-entered.

A

If the working floor heights for the job were recorded, they can be used to manually set up floors instead of running a new learn operation.

1. On Inspection Operation, verify the car is **exactly** level with floor 1. This will be the zero reference.
2. Note the value displayed on the F3 Controller System menu, Elgo screen. For example:
  - ELGO A 0000999 mm
  - ELGO B 0000839 mm
3. Through the F5 Controller Utilities menu, Default TC-MPI parameters, default the MPI board.
4. Set the F6 switch up (all others down). The display will prompt ELGO LEARN, PRESS NEXT TO CONTINUE.
5. Press N. The display will prompt: GO TO LANDING 1. PRESS SELECT.
6. Press S. The display will prompt you to enter an offset. You are exactly level with the floor so press N (DONE) without entering an offset.
7. The display will prompt you to move to the next floor and press SELECT. Instead, remain at the first floor but press S as though you had moved. When prompted for an offset value, simply press N (done).
8. Continue as described in Step 8 until all floors have been addressed. You will be prompted to move the car adjacent to the counterweight. Do so, then press N.
9. You will be prompted to store values. Press S to do so. Upon seeing the VALUES ARE STORED. LEARN IS NOW COMPLETE message, set the F6 switch to the DOWN position.

### F7 Entry

1. Obtain recorded floor heights to use as a reference.
2. Set the F7 switch UP (all others down).
3. Beginning with parameter 2 (Floor 2), re-enter floor height data for all floors.
4. Set the F7 switch DOWN.
5. Run the car to test landing accuracy. Adjust if needed.





## Numerics

### 0. LF.50-55

High speed and Earthquake operation 2-31

0.LF.26 2-33, A-3  
0.LF.51 2-34, A-4  
0.LF.52 2-34, A-4  
0.LF.55 2-34, A-4  
1.LF.50 2-34, A-4  
1.LF.51 2-34, A-4  
1.LF.52 2-34, A-4  
1.LF.53 2-34, A-4  
1.LF.54 2-34, A-4  
1.LF.55 2-34, A-4  
2 BUS IS LOW 5-3  
2 or 2xx Bus 5-2  
2.LF.52 2-34, A-4  
2.LF.53 2-34, A-4  
2.LF.54 2-34, A-4  
2AB Spare input 4-27  
2FS BUS IS LOW 5-3  
2HA BUS IS LOW 5-3  
2MV BUS IS LOW 5-3  
2S INPUT FAILURE 5-3  
702-7xx 4-36  
702R-7xxR 4-36  
801-8xx 4-36  
801R-8xxR 4-36

## A

A 4-96  
A.LF.31 2-33, A-3  
ABD INPUT FAILURE 5-3  
ABI, Alarm Bell Input option 4-27  
ABU INPUT FAILURE 5-3  
ABZ, Attendant Service Buzzer Output option 4-36  
AC Drive parameters  
TORQMAX F5 Drive A-2, A-6  
Acceleration parameter 3-11  
ACCESS ENABLED 5-3  
ACI 4-27  
Alarm Bell Input 4-27  
Alarm Reset Acknowledge input 4-27  
ALI 4-27  
Align Encoder (Magnetek) 2-47  
Alive Input 4-27  
ALLOW CAR CALLS ON WP SEC.? 4-43  
ALT. PARKING FLOOR option 4-15  
Alternate Acceleration, 182 4-120  
Alternate Curve 3-10  
Alternate Deceleration, 183 4-120  
Alternate Fire Service 4-30  
Alternate Lobby Input 4-27  
Alternate Parking Input 4-27  
Alternate Roll Jerk, 180 4-120  
Alternate Start Jerk, 179 4-120  
Alternate Stop Jerk, 181 4-120  
ALV 4-9  
ALV, Alive Input option 4-27  
ALV, Other car alive output flag 4-9

Ambient temperature 2-3  
ANALOG LOAD WEIGHER? option 4-46  
ANSI Earthquake 4-48  
API 4-9  
API, Alternate Parking Input flag 4-9  
API, Alternate Parking Input option 4-27  
ARST 4-27  
Ascending Car Overspeed Test 3-45  
ASME A17.1A 2005 ADDENDA 4-17  
ATD INPUT FAILURE 5-4  
ATS, Attendant Service Input option 4-27  
ATS. BYPASS SECURITY? option 4-47  
Attendant Service Buzzer Output 4-36  
Attendant Service Input 4-27  
ATTENDANT SERVICE OPERATION 5-4  
ATU INPUT FAILURE 5-4  
Audible Car Call Registered Output 4-36  
AUTO 4-9  
AUTO, Emergency power auto output flag 4-9  
AUTO, Emergency Power Auto Selection Input option 4-27  
AUTOMATIC MODE FAULT BYPASS 4-55  
Automatic Mode Fault Bypass 2-15, 2-29, 3-7, 3-36  
Auto-tuning AC Induction Motors 2-21, 2-27  
Auxiliary Position Indicators 4-41  
Auxiliary Reset Input 4-27  
Auxiliary Speed, 153 4-118  
Auxiliary Supervisory Down Arrow 4-41  
Auxiliary Supervisory Up Arrow 4-41  
AXR, Auxiliary Reset Input option 4-27

## B

BAB Spare input 4-27  
Backup Power alerting input 4-27  
Backup Power Speed 4-118  
Basic Feature Menu options 4-13, 4-14  
Basic Security 4-53  
programming or changing the Security codes 4-54  
BATTERY BACKUP POWER SYSTEM FAULT 5-4  
BATTERY POWER CAR RECALL ACTIVATED 5-4  
Battery replacement 5-52  
BFD 4-9  
BFD, Bottom floor demand flag 4-9  
BMS-LINK 1-17  
Board Software Versions 4-125  
Both USD and DSD are Open message 5-36  
BOTTOM 4-36  
Bottom Access Bypass Monitor 5-17  
Bottom Access Distance, 65 4-108  
Bottom Access Door Contact 5-6  
BOTTOM ACCESS SW. FAILURE 5-4  
BOTTOM ACCESS? 4-49  
Bottom Down Access (ABD) switch 5-3  
Bottom Floor Demand message 5-5  
Bottom floor level 4-108  
BOTTOM FLOOR OR TOP FLOOR DEMAND 5-5  
Bottom landing output 4-36  
Bottom Rear Access Monitor 5-17  
BPCR 4-27  
BPS 4-27  
Bracelet Security 4-34, 4-43

## Brake

- Adjust to hold 125% 2-73
- Brake control module 5-76
- Brake Coordination 3-20
- Brake Drop Delay 4-116
- Brake Drop Time 2-12
- Brake Hold Delay Time 4-116
- Brake lining 2-12
- Brake module
  - DIP switches 5-78
  - External filtering 5-81
  - LED fault indication 5-78
  - Switches and Jumpers 5-77
- BRAKE MODULE FAULT LIMIT REACHED 5-5
- Brake Pick Delay Time 4-115
- BRAKE PICK FAILURE 5-5
- Brake Pick Switch input. 4-27
- Brake Type Option 4-120
- BRP INPUT FAILED TO ACTIVATE 5-5
- BRP INPUT FAILED TO DEACTIVATE 5-5
- BSI, Building Security Input option 4-27
- Buffer Test 3-41
- Building Security Input 4-27
- Bumpy transitions 2-30
- Bypass Faults 2-29
- BYPASS STOP SW. ON PHASE 1 option 4-16
- Bypassing Faults on Inspection 2-29, 2-55

## C

- Calibrate a brake module 4-96
- California Earthquake 4-48
- CAN Bus 1-3
- CAN Bus termination 5-63
- CAN connections inside controller 5-39
- CANCEL BOTH HALL (U/D) CALLS 4-47
- CANCEL CAR CALLS BEHIND CAR 4-44
- Cannot reach contract speed 2-30
- CAPTURE FOR TEST 5-5
- Capture for Test Input 4-28
- Car and Hoistway Bypass Output 4-36
- CAR CALL BUS IS DISCONNECTED 5-5
- Car Call Cancellation Output (900) option 4-36
- CAR CALL CANCELS DOOR TIME option 4-18
- Car call card reader override 4-28
- Car call card reader. 4-28
- Car Call Disconnect Enable Output 4-36
- CAR CALL DOOR TIMER 4-23
- Car Call Time Flag Output 4-36
- Car Calls Cancel Input 4-27
- Car Card Reader Outputs 4-36
- Car Controller
  - installation of 2-6
  - wiring prints 2-5
- Car Done Returning on Emergency Power Output 4-36
- CAR DOOR BYPASS SW. FAILURE 5-6
- CAR DOORS ARE WALK-THRU option 4-14
- Car Gong Enable Down Output 4-36
- Car Gong Enable Up Output 4-36
- CAR IDENTIFIER option 4-15
- CAR IN TEST MODE 5-6

- Car lantern actuation point 4-25
- CAR LANTERN DOOR FULLY OPEN? 4-25
- Car Oscillates at Contract Speed 3-21
- Car Overshoots 3-21
- Car position 4-55
- Car runs at less than commanded speed 2-30
- Car runs too slow 2-30
- CAR SAFETY DEVICE OPEN 5-6
- Car safety string input 4-33
- Car Safety Test 3-45
- Car Selected to Run Output 4-37
- CAR SERVES FRNT/FLR 1 option 4-14
- Car speed 2-15, 3-7, 3-35
- Car Stop Switch Bypass Output 4-37
- CAR TO FLOOR FUNCTION 5-6
- Car to floor Input 4-28
- CAR TO FLOOR RETURN FLOOR option 4-47
- CAR TO LOBBY OPERATION 5-6
- Car top box dimensions 1-7
- CAR TOP INSPECTION 5-6
- Car will not move down 2-29
- Car-to-Lobby Door Open Timer Output 4-37
- Car-to-Lobby Input 4-28
- CC 4-9
- CC CARD READER SECURITY 4-43
- CC, Car call flag 4-9
- CCA, Car call above flag 4-9
- CCB, Car call below flag 4-9
- CCC, Car call cancel input flag 4-9
- CCC, Car Calls Cancel Input option 4-27
- CCD, Car call disconnect flag 4-9
- CCDE, Car Call Disconnect Enable Output option 4-36
- CCH, Car call hold flag 4-9
- CCR, Car call flag (rear) 4-9
- CCT, Car call time flag 4-9
- CCT, Car Call Time Flag Output option 4-36
- CCTR, Car call time flag (rear) 4-9
- CD, Car done flag 4-9
- CD, Car Done on Emergency Power Output option 4-36
- CE ELECTRONICS BOARD 4-44
- CEPR 4-36
- CFLT, CFLT Output option 4-36
- CGED for rear doors Output 4-36
- CGED, Car Gong Enable Down Output option 4-36
- CGEDR, CGED for rear doors Output option 4-36
- CGEU for rear doors Output 4-36
- CGEU, Car Gong Enable Up Output option 4-36
- CGEUR, CGEU for rear doors Output option 4-36
- CGF, Car Generated Fault Output option 4-36
- Changing Parameters 4-11
- CHBPO 4-36
- Check Car Speed 2-15, 3-7, 3-35
- Check for shorts 2-9
- Clear drive error 2-18, 2-24
- Clear Event Log 4-63
- Clear events 4-63
- CMD 4-96
- CNFG, Configuration error flag 4-9
- CNP, Contactor Proof Input option 4-28
- Code Sequence Enable Output 4-37

Commanded and actual pick voltage 4-96  
 Communication baud rate, External CAN bus 5-40  
 Complimented PTI Input 4-32  
 Computer Generated Fault Output 4-36  
 Computer Internal Memory 4-6  
 conF 2-21  
 CONFIGURATION ERROR CHANGE SETTINGS BEFORE  
 INSTALLATION 5-6  
 Connection Set 1-16  
 Connections screen 4-93  
 CONST. PRESS OP. BYPASS PHE 4-21  
 Construction operation 2-28  
 Construction operation jumpers 2-28  
 CONT. D.C.B. FOR FIRE PH 1 option 4-20  
 CONT. D.C.B. TO CLOSE DOORS option 4-20  
 Contactor Proof Input 4-28  
 CONTRACT OVERSPEED 5-21, 5-29  
 Contract Overspeed 4-117  
 Contract Rotation 4-118  
 Contract Speed 4-117  
 Control parameters  
     KEB/Torqmax, Magnetek 2-46  
 Controller inspection 2-54  
 Controller reset 4-4  
 CORRECTION AWAY FROM CW 4-49  
 Correction Speed 4-118  
 Counterweight balancing, preparing for final adjust 3-6  
 Counterweight Input 4-28  
 Counterweight Position 4-109  
 Counterweight Safety Test 3-46  
 CRO1-CR8 4-36  
 CRO1R-CR8R 4-37  
 CR1-CR8 4-28  
 CR1R-CR8R 4-28  
 CR2032 battery voltage 5-6  
 CRO 4-28  
 CSA FAULT OUTPUT 4-36  
 CSB, Car stop switch bypass flag 4-9  
 CSB, Car Stop Switch Bypass Output option 4-37  
 CSBR, Car stop switch bypass (rear) flag 4-9  
 CSEO, Code Sequence Enable Output option 4-37  
 CSR, Car Selected to Run Output option 4-37  
 CTF Car To Floor 1-15  
 CTL Car to Lobby 1-15  
 CTL, Car to lobby input flag 4-9  
 CTL, Car-to-Lobby Input option 4-28  
 CTLDOT, Car to lobby door open timer flag 4-9  
 CTLDOT, Car-to-Lobby Door Open Timer Output option 4-37  
 CTLF, Car to lobby function flag 4-9  
 CTP, Car to floor Input option 4-28  
 CTST, Capture for test input flag 4-9  
 CTST, Capture for Test Input option 4-28  
 CWI 4-28  
 CYCLE TEST 5-6

## D

D = Dispatcher 4-6  
 D in upper left corner of the LCD 5-37  
 D.C.B. CANCELS DOOR TIME option 4-19  
 d.LF.32 2-33, A-3  
 Danger "Curve" 3-10  
 Danger Deceleration 4-119  
 Danger Roll Jerk 4-119  
 Danger Slew Slope 4-116  
 Danger Start Jerk 4-119  
 Danger Stop Jerk 4-119  
 Date / Time Stamp 4-63  
 Date/Time, View / Adjust 4-63  
 DBC, Door close button input flag 4-9  
 DBCR, Door close button (rear) flag 4-9  
 DBZF, Front Door Buzzer output option 4-37  
 DBZR, Rear Door Buzzer output option 4-37  
 DC, Down call flag 4-9  
 DCA, Down call above flag 4-9  
 DCAB INPUT FAILURE 5-6  
 DCB, Down call below flag 4-9  
 DCC, Door close complete flag 4-9  
 DCCR, Door close complete flag (rear) 4-9  
 DCF, Door close function output flag 4-9  
 DCFR, Door close function output (rear) flag 4-9  
 DCFRX 4-37  
 DCFX 4-37  
 DCL, Door Close Limit Input option 4-28  
 DCLC 4-9  
 DCLC, Doors Closed Contact Input option 4-28  
 DCLCR INPUT FAILURE 5-7  
 DCLCR, Door close contact input (rear) flag 4-9  
 DCLR 4-28  
 DCP, Door close power output flag 4-9  
 DCPR, Door close power output (rear) flag 4-9  
 DCPRX 4-37  
 DCPX 4-37  
 DCR, Down call flag (rear) flag 4-9  
 DDF, Double ding function flag 4-9  
 DDP, Down direction preference flag 4-9  
 DEADZ, Dead zone flag 4-9  
 Deceleration parameter 3-11  
 DEDICATED PI BOARD? 4-15  
 Default brake module values 4-96  
 Default parameter values 4-5  
 Default TC-FCL Parameters 4-96  
 Default TC-MPI Parameters 4-63  
 Default the TC-MPI 4-63  
 Default XPort screen 4-95  
 DEIS 4-38  
 DEISR 4-38  
 Delta speeds 4-112  
 DETS 4-114  
 DETS Delta Distance, 106 4-114  
 DETS Delta High Speed 4-114  
 DETS Distance 4-114  
 DETS POSITION FAULT 5-21  
 DETS Speed 4-114  
 Device Data screen 4-94  
 DFI 4-28

DHEND 4-37  
 DHEND, Door hold end flag 4-9  
 DHEND, Door Hold End Output option 4-37  
 DHEND2, Door hold end rear flag 4-9  
 DHENDR 4-37  
 DHLD, Door hold input flag 4-9  
 DHLD, Door Hold Input for Normal Service option 4-28  
 DHLDI, Normal door hold input flag 4-9  
 DHLDR, DHLD for Rear Doors option 4-28  
 DHO 4-37  
 DHO, Door hold open flag 4-9  
 DHO, Door Hold Output option 4-37  
 DHOR, Door hold open flag (rear) 4-9  
 Diagnostic Mode 4-6, 4-8  
 DIN, Door open inactive flag 4-9  
 DIR. PREFERENCE UNTIL DLK option 4-20  
 Directional Limit 4-109  
 Directional Limit Distance 4-109  
 Directional Limit Type, 202 4-123  
 DISABLE DPM ON FIRE PH.2 4-17  
 DISABLE DPM ON FIRE PH.2? 4-17  
 DISABLE LOCAL HALL CALLS 4-16  
 DISABLE TOP FLRS ON PITFLD 4-47  
 DISB 4-37  
 DISL 4-37  
 DISLX 4-37  
 Dispatch Load Input 4-28  
 Display car speed 2-15, 3-7, 3-35, 4-55  
 Display current position 4-55  
 Display position 4-55  
 Distress Buzzer 4-37  
 Distress Light 4-37  
 Distress Light Auxiliary 4-37  
 DL INPUT FAILURE 5-7  
 DLI, Dispatch Load Input flag 4-9  
 DLI, Dispatch Load Input option 4-28  
 DLK, Door lock input flag 4-9  
 DLKS, Door lock store bit flag 4-9  
 DLOB 4-37  
 DLOB, Door Left Open Bell Output option 4-37  
 DLR INPUT FAILURE 5-7  
 DLS 4-29  
 DLSR 4-29  
 DLW, Dispatch load weighing function flag 4-9  
 DMD, Demand down flag 4-10  
 DMU, Demand up flag 4-10  
 DNDO, Down direction output flag 4-10  
 DNENDR, Door Hold End Rear Output option 4-37  
 DNI, Down Input (Attendant Service) option 4-29  
 DNO 4-37  
 DNO, Down output (Attendant Service) option 4-37  
 DNS 4-37  
 DNS, Down direction sense input flag 4-10  
 DNT1 5-74  
 DNTS POSITION FAULT 5-22  
 DNTS1 Delta Distance 4-114  
 DNTS1 Delta High Speed 4-114  
 DNTS1 Distance 4-114  
 DNTS1 Speed 4-114  
 DNTS2, 3, 4, 5 4-115  
 DOI, DO2, DO4, DO8, DO16, DO32  
     Binary coded P.I. outputs for digital P.I. devices 4-37  
 DOB, Door open button input flag 4-10  
 DOBR, Door open button input (rear) flag 4-10  
 DOC, Door open command flag 4-10  
 DOCR, Door open command (rear) flag 4-10  
 DOF, Door open function output flag 4-10  
 DOFR, Door open function output (rear) flag 4-10  
 DOFRX 4-37  
 DOFX 4-37  
 DOI, Door open intent flag 4-10  
 DOIR, Door open intent flag (rear) 4-10  
 DOL Door Open Limit 4-29  
 DOL INPUT FAILURE 5-7  
 DOL, Door open limit input flag 4-10  
 DOLM, Door open limit memory flag 4-10  
 DOLMR, Door open limit memory flag (rear) 4-10  
 DOLR Door Open Limit Rear 4-29  
 DOLR INPUT FAILURE 5-7  
 DOLR, Door open limit (rear) flag 4-10  
 Door 1-5  
 Door close function 5-42  
 Door Close Function Auxiliary 4-37  
 Door Close Limit Input 4-28  
 DOOR CLOSE LIMITS? option 4-49  
 Door close power 5-42  
 Door Close Power Auxiliary 4-37  
 Door Close Protection message 5-8  
 DOOR CLOSE PROTECTION TIMER ELAPSED 5-8  
 Door Enable Inspection Stop Switch 4-38  
 Door Enable Inspection Stop Switch Rear 4-38  
 Door Enable Output 4-38  
 Door Hold End Output 4-37  
 Door Hold End Output Rear 4-37  
 Door Hold Input 4-28  
 Door Hold Output 4-37  
 Door Left Open Bell Output 4-37  
 Door lock bypass 5-41  
 Door Lock Sensor Input 4-29  
 Door mechanically coupled selection 4-21  
 Door Nudging Auxiliary output 4-40  
 Door open function 5-42  
 Door Open Function Auxiliary 4-37  
 Door Open Limit input 4-29  
 DOOR OPEN PROTECTION TIMER 4-24  
 Door Operation Menu options 4-18, 4-20, 4-21  
 DOOR POSITION MONITOR 4-49  
 Door Position Monitoring 4-29  
 Door Stop Input 4-29  
 Door Stop Input Complement 4-29  
 Door style selection 4-21  
 Door Time Shortening Front Output 4-38  
 Door Time Shortening Output 4-38  
 Door Time Shortening Rear Output 4-38  
 DOOR TYPE IS HORIZONTAL / VERTICAL 4-21  
 DOOR ZONE SENSOR FAILURE - ON POSITION 5-8  
 DOOR ZONE SENSOR FAILURE OFF POSITION 5-8  
 Door Zone Verification 3-5  
 DOORENAB 4-38  
 Doors Closed Contact Input 4-28

DOORS TO LATCH DCF 4-22  
 DOORS TO LATCH DOF 4-22  
 DOORS TO OPEN IF NO DEMAND option 4-21  
 DOORS TO OPEN IF PARKED option 4-20  
 DOORS TO OPEN ON ALT FIRE option 4-21  
 DOORS TO OPEN ON MAIN FIRE option 4-20  
 Down Emergency Terminal overspeed 5-21  
 Down Input (Attendant Service) 4-29  
 Down Normal Terminal Switch High overspeed 5-21  
 Down Normal Terminal Switch Low overspeed 5-22  
 Down output (Attendant Service) 4-37  
 Down Sense 4-37  
 DPD, Down previous direction flag 4-10  
 DPM Fault 5-8  
 DPM REDUNDANCY FAULT 5-8  
 DPM, Front Door Position Monitoring option 4-29  
 DPMR fault 5-8  
 DPMR REDUNDANCY FAULT 5-8  
 DPMR, Rear Door Position Monitoring option 4-29  
 DPR, Door protection timer flag 4-10  
 Drawing numbers, description of 2-5  
 Drive configuration 2-32, A-2  
 Drive Disable Delay Time 4-116  
 Drive error, clearing 2-18, 2-24  
 DRIVE FAULT 5-9  
 Drive Fault Input 4-28  
 Drive Motor/Encoder Setup 2-20, 2-26  
 Drive On Input 4-29  
 Drive overvoltage fault 3-23  
 Drive response adjustment 3-13  
 DRIVE RX COMM FAILURE 5-9  
 DRIVE TX COMM FAILURE 5-9  
 Drive Type 4-120  
 DRON 4-29  
 DSD, Down slow down input flag 4-10  
 DSH, Door shortening flag 4-10  
 DSH, Door Time Shortening Output (intermediate) 4-38  
 DSHT, Door shortening flag 4-10  
 DSHT, Door Time Shortening Front Output (final) 4-38  
 DSHTR, Door shortening flag (rear) 4-10  
 DSHTR, Door Time Shortening Front Output (rear) 4-38  
 DSTI, Door Stop Input option 4-29  
 DSTIC 4-29  
 DSTICR 4-29  
 DSTIR, DSTI for rear doors option 4-29  
 Duplex connection 2-72  
 Duplex dispatcher (D) or a local (L) 4-93  
 Duplex operation JP3 4-13  
 Duplexing 5-37  
 DZ, Door zone input flag 4-10  
 DZORDZ, Front or rear door zone input flag 4-10  
 DZP, Door zone previous flag 4-10  
 DZR, Door zone input (rear) flag 4-10  
 DZRX 4-29  
 DZX 4-29

## E

E.ENCC Fault 2-47  
 Earthquake Direction Switch 4-29  
 Earthquake Direction Terminal Limit Switch 4-29  
 Earthquake indicator output. 4-38  
 Earthquake Input 4-30  
 EARTHQUAKE OPERATION 5-9  
 Earthquake run speed 1-13  
 Earthquake Speed 4-117  
 ECC, Excess car calls flag 4-10  
 ECRN, Emergency Car Freeze Input option 4-29  
 ECRN, Emergency car run flag 4-10  
 ECRN, Emergency Power Car Run Output option 4-38  
 EDS 4-29  
 EDTLS 4-29  
 EFG, Egress Floor Gong Output option 4-38  
 Egress Floor Gong Output 4-38  
 Electrical noise 2-4  
 Electrostatic Discharge 2-7  
 Elevator Shutdown Input 4-30  
 ELEVATOR SHUTDOWN SWITCH ACTIVE 5-9  
 ELGO A 4-55  
 ELGO B 4-55  
 ELGO CAN channel loss 5-25  
 EMERGENCY BRAKE ACTIVATED 5-9  
 Emergency Brake Hold Voltage, 201 4-122  
 Emergency Brake Option 4-120, 4-123  
 Emergency Brake Pick Voltage, 200 4-122  
 Emergency Brake Type, 199 4-122  
 Emergency Car Freeze Input 4-29  
 Emergency Dispatch Input 4-34  
 EMERGENCY MEDICAL SERVICE 5-9  
 Emergency Medical Service (EMS) hallway switch input 4-29  
 Emergency Medical Service (EMS) in-car switch input 4-29  
 Emergency Medical Service Buzzer Output 4-38  
 Emergency Medical Service Indicator Car Output 4-38  
 Emergency Medical Service Indicator Hall Output 4-38  
 Emergency Power Auto Selection Input 4-27  
 Emergency Power Car Run Output 4-38  
 Emergency Power Input 4-29  
 Emergency Power message 5-9  
 EMERGENCY POWER OPERATION 5-9  
 Emergency Power Phase 1 Output 4-38  
 Emergency Power Phase 2 Output 4-38  
 Emergency Power Return 4-36  
 Emergency Power Return Incomplete Output 4-40  
 Emergency Power Return Input 4-29  
 Emergency Power Run Input 4-30  
 Emergency Power Stop Input 4-30  
 Emergency Terminal Slowdown 4-111  
 EMI/RFI interference 2-4  
 EMSB, Emergency Medical Service Buzzer Output 4-38  
 EMSC, Emergency Medical Switch Car option 4-29  
 EMSH, Emergency Medical Switch Hall option 4-29  
 EMSIC, Emergency Medical Service Indicator Car Out 4-38  
 EMSIH, Emergency Medical Service Indicator Hall Out 4-38  
 ENABLE FRONT DOB ON SECURITY 4-48  
 ENABLE REAR DOB ON SECURITY 4-47  
 Encoder data download 2-23  
 Encoder Data for PM AC Drives 2-23

Encoder installation 2-13  
 Encoder Mounting 2-13  
 Encoder type verification 2-23  
 Encoder Wiring 2-13  
 EnDat 2-23  
 English 4-64  
 ENTER SECURITY CODE 5-9  
 EP1, Emergency Power Phase 1 Output option 4-38  
 EP2, Emergency Power Phase 2 Output option 4-38  
 EPI, Emergency power input flag 4-10  
 EPI, Emergency Power Input option 4-29  
 EPR, Emergency power return flag 4-10  
 EPR, Emergency Power Return Input option 4-29  
 EPRUN 4-42  
 EPRUN, Emergency power run input flag 4-10  
 EPRUN, Emergency Power Run Input option 4-30  
 EPSTP, Emergency power stop input flag 4-10  
 EPSTP, Emergency Power Stop Input option 4-30  
 EQ SHUTDOWN AT LANDING 4-49  
 EQ SHUTDOWN PH1 FIRE SERV 4-49  
 EQ SHUTDOWN PH2 FIRE SERV 4-49  
 EQI 4-30  
 EQIND 4-38  
 Error diagnostic display 4-94  
 ESS, Elevator Shutdown Input option 4-30  
 ET SW SHUTDOWN FAULT 5-23  
 Ethernet 1-16  
 ETS Switch Delta Values 3-17  
 ETS SWITCHES REQUIRED 4-49  
 ETS Testing 3-44  
 ETSL 4-111  
 ETSL switch 3-18  
 Event Calendar 4-63  
 Excessive faults 2-16, 3-37  
 EXCESSIVE FAULTS SHUTDOWN 5-23  
 Extended Motor Cables 2-11  
 External CAN Bus baud rate 5-40  
 External Memory Mode 4-52  
 External Memory mode 4-50  
 Extra Features Menu options 4-42, 4-43, 4-45, 4-46

## F

F1 - F8 4-3  
 F1 (Program Mode) 3-2  
 Fan/Light Operation Output 4-38  
 FAN/LIGHT OUTPUT TIMER 4-24  
 Fault Bypass 2-29  
 FCCC, Fire Phase 2 Call Cancel Button Input option 4-30  
 FCCC, Fire phase 2 car call cancel flag 4-10  
 FCHLD, Fire phase 2 hold flag 4-10  
 FCHLD, Fire Phase 2 Switch HOLD Position Input 4-30  
 FCL 1 - 4 - AUX IGBT STUCK OPEN 5-10  
 FCL 1 - 4 - BYPASS BUTTON STUCK CLOSED 5-10  
 FCL 1 - 4 - CAN DISCONNECTED 5-10  
 FCL 1 - 4 - DISCRETE INPUT WHILE IN CAN MODE 5-10  
 FCL 1 - 4 - LOAD OVER CURRENT 5-11  
 FCL 1 - 4 - LOAD OVER VOLTAGE 5-11  
 FCL 1 - 4 - LOAD UNDER CURRENT 5-11  
 FCL 1 - 4 - LOAD UNDER VOLTAGE 5-11  
 FCL 1 - 4 - MAIN IGBT STUCK CLOSED 5-12  
 FCL 1 - 4 - MAIN IGBT STUCK OPEN 5-12  
 FCL 1 - 4 - MODULE ADDRESS ERROR 5-12  
 FCL 1 - 4 - MODULE OVERHEAT 5-12  
 FCL 1 - 4 - NOT CALIBRATED 5-12  
 FCL 1 - 4 - TRYING TO RUN IN MAN RELEASE MODE 5-12  
 FCL 1 - 4 faults 5-10  
 FCL 1 - 4 IN MANUAL MODE 5-10  
 FCL 1 - 4 LOAD EXTREME UNDER CURRENT 5-11  
 FCL 1 - 4 LOAD EXTREME UNDER VOLTAGE 5-11  
 FCL Adjustment Menu 4-96  
 FCL Diagnostic Menu 4-96  
 FCL Power Data Menu 4-96  
 FCOFF, Fire phase 2 off flag 4-10  
 FCOFF, Fire Phase 2 Switch OFF Position Input option 4-30  
 FCS, Fire phase 2 input flag 4-10  
 FCSM, Fire service phase 2 input memory flag 4-10  
 FDC, Door fully closed phase 2 flag 4-10  
 FDCR, Door fully closed phase 2 (rear) flag 4-10  
 Final Limit 3-22  
 Final Limit Switches 4-109  
 FIR1, Fire Service Phase I output option 4-38  
 FIRE BYPASSES HOSPITAL option 4-46  
 FIRE PH1 RECLOSE TIMER 4-24  
 FIRE PH2. WITH DOORS CLOSED 4-22  
 FIRE PHASE 1 ALT. FLOOR option 4-16  
 FIRE PHASE 1 MAIN FLOOR option 4-16  
 Fire Phase 1 Switch ON Position Input 4-30  
 FIRE PHASE I 2ND ALT. FLOOR option 4-16  
 Fire Phase I Alternate Switch ON Position Input 4-30  
 Fire Phase I Second Alternate Input 4-30  
 Fire Phase I Switch BYPASS Position Input 4-30  
 Fire Phase II Call Cancel Button Input 4-30  
 Fire Phase II Door Hold Input 4-30  
 Fire Phase II OFF Input 4-30  
 Fire Service Alternate 5-12  
 Fire Service Alternate Output 4-39  
 Fire Service Buzzer Auxiliary output. 4-39  
 Fire Service Light COP Auxiliary output. 4-39  
 Fire Service Light Lobby Auxiliary output 4-39  
 Fire Service Main message 5-13  
 Fire Service Main Output 4-39

FIRE SERVICE MENU OPTIONS 4-16  
 Fire Service On Output 4-39  
 FIRE SERVICE OPERATION option 4-16  
 FIRE SERVICE PHASE 1 ALTERNATE 5-12  
 FIRE SERVICE PHASE 1 MAIN 5-13  
 Fire Service Phase 1 Return Complete Output 4-41  
 FIRE SERVICE PHASE 2 5-13  
 Fire Service Phase I Output 4-39  
 Fire Service Phase I output 4-38  
 Fire Service Phase II Output 4-38  
 Fire Service Phase II True Output 4-39  
 FIRE SVCE. CODE option 4-16  
 Fire Warning Light Output 4-39  
 Flags/Variables and Their Locations 4-9  
 Flare jerk parameter 3-11  
 Flash output 4-38  
 FLASH, Flash output option 4-38  
 Flashing In Service Output 4-40  
 FLO, Fan/Light Operation Output option 4-38  
 FLR COUNT BELOW FLOOD LEVEL? 4-47  
 FLTM 4-30  
 Following Error 4-121  
 FRA, Alternate Fire service phase 1 input flag 4-10  
 FRAA, Fire Phase 1 Alternate (2nd alternate) Input 4-30  
 FRAON, Fire Phase 1 Alternate Switch ON Position 4-30  
 FRAS, Alternate fire flag 4-10  
 FRBYP, Fire phase 1 bypass input flag 4-10  
 FRBYP, Fire Phase 1 Switch BYPASS Position Input 4-30  
 FRC, Fire phase 2 flag 4-10  
 FRC, Fire Service Phase 2 Output option 4-38  
 FRCT 4-39  
 FREE, No demand and in service flag 4-10  
 FRHTW 4-30  
 FRM, Fire service phase 1 flag 4-10  
 FRM, Fire Service Phase 1 Output option 4-39  
 FRMR 4-30  
 FRON, Fire phase 1 on input flag 4-10  
 FRON, Fire Phase 1 Switch ON Position Input option 4-30  
 FRON2, Fire Phase 1 Switch ON Position Input option 4-30  
 Front Access Gate Bypass Monitor 5-17  
 FRONT DOL AND DLK ARE BOTH ACTIVE 5-13  
 Front Door Buzzer 4-37  
 FRONT DOOR FAILED TO CLOSE 5-13  
 FRONT DOOR IS LOCKED BUT NOT FULLY CLOSED 5-13  
 FRONT DOOR LOCK SWITCH FAILURE 5-13  
 FRONT DOOR MECH. COUPLED? 4-21  
 FRONT DOOR OPEN LIMIT FAILURE 5-13  
 Front Down Hall Call indicators 4-36  
 FRONT DZ RELAY DISCREPANCY 5-13  
 FRONT GATE SWITCH FAILURE 5-13  
 Front Infrared Cutout 4-31  
 Front Up Hall Call indicators 4-36  
 FRS, Fire phase 1 input flag 4-9  
 FRSA, Alternate Fire Service input option 4-30  
 FRSM, Main Fire Service input option 4-30  
 FRSS, Fire phase 1 flag 4-9  
 FSA, Fire Service Alternate Output option 4-39  
 FSLCX 4-39  
 FSSLX 4-39  
 FSM, Fire Service Main Output option 4-39

FSO, Fire Service On Output option 4-39  
 FSVC, True Fire Service Output option 4-39  
 FULLY MANUAL DOORS option 4-20  
 FWI, Fire warning indicator output flag 4-9  
 FWIX 4-39  
 FWL, Fire Warning Light Output option 4-39

## G

Gate Switch Input 4-30  
 Gate Switch Monitor 5-18  
 Gate Switch Rear Input 4-30  
 Gateway screen 4-93  
 GDOI 4-39  
 GED, Gong enable down output flag 4-9  
 GEDR, Gong enable down output (rear) flag 4-9  
 GEDRX 4-39  
 GEDX 4-39  
 Generator Backup 1-14  
 GEU, Gong enable up output flag 4-9  
 GEUR, Gong enable up output (rear) flag 4-9  
 GEURX 4-39  
 GEUX 4-39  
 GHT, Gong hold timer flag 4-9  
 GHTR, Gong hold timer flag (rear) 4-9  
 Gong Enable Down Auxiliary. 4-39  
 Gong Enable Up Auxiliary 4-39  
 Gongs/Lanterns Menu options 4-25  
 GOV 4-30  
 GOVERNOR OVERSPEED 5-23, 5-24  
 Governor switch input 4-30  
 GOVERNOR SWITCH OPEN 5-14  
 GRAY CODE 4-42  
 Gray Code outputs 4-39  
 Gray Code PI 4-39  
 Grounding 2-7  
 GROUP TO CAR COMMUNICATION LOST 5-14  
 GS INPUT FAILURE 5-14  
 GS, Gate Switch Input option 4-30  
 GSR INPUT FAILURE 5-14  
 GSR, Gate Switch Rear Input option 4-30  
 GTDE, Gong timer down enable flag 4-9  
 GTUE, Gong timer up enable flag 4-9

## H

H 4-39  
H, High speed output flag 4-9  
HALL AND CAR CALL BUSES DISCONNECTED 5-14  
Hall Call Bus Failure input 4-30  
HALL CALL BUS IS DISCONNECTED 5-14  
Hall Call Cancel 4-31  
HALL CALL DOOR TIMER 4-23  
Hall Call Pushed Output 4-39  
Hall Call Reject Output 4-39  
Hall call, serial 2-72  
Hall Card Reader 4-39  
Hall Card Reader Inputs 4-31  
Hall Card Reader Override input 4-31  
Hall Door Close Button 4-31  
Hall Door Close Button. 4-31  
Hall Door Open Button 4-31  
Hall Door Stop Input 4-31  
HBF 4-30  
HCC 4-31  
HC-CHP CAN Hub and Power Supply Board 5-39  
HC-CHP, CAN Hub/Power Supply 1-5  
HC-CTL Control board 5-41  
HC-CTL, Control Board 1-5  
HCDX, Hall call disconnect flag 4-9  
HC-MPU board 5-50  
HCP, Hall call pushed output option 4-39  
HCR, Hall call reject flag 4-9  
HCR, Hall Call Reject Output option 4-39  
HCR01-HCRxx 4-39  
HCR01R-HCRxxR 4-39  
HCR1 - 8 4-31  
HCR1R-8 4-31  
HC-RDR BOARD ON THE OTHER CAR? 4-14  
HC-RDR BOARD ON THIS CAR? 4-14  
HC-RDR Rear Door board 5-53  
HCRO 4-31  
HCT, Hall call door time flag 4-9  
HCTR, Hall call door time flag (rear) 4-9  
HC-UIO 1-5  
HC-UIO Universal I/O 1-8  
HC-UIO, Universal Input/Output Board 1-5  
HD, High speed delay flag 4-9  
HDCB 4-31  
HDCBR 4-31  
HDNL 4-39  
HDOB 4-31  
HDOBR 4-31  
HDSC, Heat Detector Shutdown Complete Output 4-39  
HDSTI 4-31  
HDSTIR 4-31  
Heat Detector Input 4-31  
Heat Detector Shutdown 4-39  
HEATD, Heat Detector Input option 4-31  
Heavy Load Input 4-31  
HEAVY LOAD WEIGHER CONDITION 5-14  
Heavy Load Weigher Output 4-39  
HEO 4-39, 4-45  
High roll jerk parameter 3-11  
High Speed 4-117  
HIGH SPEED DELAY AFTER RUN 4-46  
High speed parameter 3-11  
Hiperface 2-23  
HLI, Heavy load input flag 4-9  
HLI, Heavy Load Input option 4-31  
HLW, Heavy load weigher flag 4-9  
HLW, Heavy Load Weigher Output option 4-39  
HML, Home landing input flag 4-9  
HML, Home Landing Input option 4-31  
Hoist Motor Speed 4-117  
HOISTWAY ACCESS 5-14  
Hoistway access 4-108  
Hoistway Access Bottom Up 5-3  
HOISTWAY ACCESS? 4-49  
Hoistway Door Bypass 5-19  
HOISTWAY DOOR BYPASS SW. FAILURE 5-14  
Hoistway Fire Sensor 4-30  
Hoistway Learn 4-97  
HOISTWAY SAFETY DEVICE OPEN 5-15  
Hoistway safety string input 4-33  
Hoistway switches 4-109  
Home Landing Input 4-31  
HONEYWELL FIRE OPERATION option 4-17  
HOSP, Hospital Emergency Operation Input option 4-31  
HOSP, In car hospital emergency input flag 4-9  
HOSPH2 4-40, 4-45  
HOSPH2, Hospital emergency phase 2 flag 4-9  
HOSPITAL EMERG. TIMER 4-24  
Hospital Emergency Car Select 4-40  
Hospital Emergency Operation 4-39, 4-45, 5-59  
Hospital Operation I/O 5-59  
HOSPITAL PHASE 1 OPERATION 5-15  
Hospital Phase 2 4-40  
HOSPITAL PHASE 2 OPERATION 5-15  
Hospital Service message 5-15  
Hospital Warning Indicator 4-40  
HSEL 4-40, 4-45  
HSEL, Hospital service select flag 4-9  
HUNL 4-40  
HWI 4-40, 4-45  
HYD1-TRO, Hydro/Traction flag 4-9



## I

- [I9LSS 2-32, A-2](#)
- [ICLSd 2-32, A-2](#)
- [ICPD INPUT FAILURE 5-15](#)
- [ICPU INPUT FAILURE 5-15](#)
- [ICTD INPUT FAILURE 5-15](#)
- [ICTU INPUT FAILURE 5-15](#)
- [IDC connector 5-2](#)
- [iMonitor 1-16](#)
- [IN CAR STOP SWITCH ACTIVATED 5-15](#)
- [In Service and Running Output 4-40](#)
- [In Service Output 4-40](#)
- [In Use Light output 4-40](#)
- [IN, Inspection or access input flag 4-9](#)
- [INA INPUT FAILURE 5-15](#)
- [INA Spare input 4-31](#)
- [In-car Hospital Service Switch Input 4-31](#)
- [IN-CAR INSPECTION 5-15](#)
- [In-car stop switch 5-15](#)
- [INCF, Independent service car call cancel flag 4-9](#)
- [INCP INPUT FAILURE 5-15](#)
- [INCT INPUT FAILURE 5-16](#)
- [IND, Independent service input flag 4-9](#)
- [IND, BYPASS SECURITY? option 4-46](#)
- [Independent Service message 5-16](#)
- [INDEPENDENT SERVICE OPERATION 5-16](#)
- [Independent Service Output 4-40](#)
- [Independent Service/Fire Service Phase 2 Output 4-40](#)
- [INDFRC, Independent Service/Fire Service Phase 2 4-40](#)
- [INDO 4-40](#)
- [Infant Abduction Security 4-34, 4-43](#)
- [Initial power up 2-10](#)
- [INSDN 4-31](#)
- [INSP 4-40](#)
- [Inspection 4-40, 5-41](#)
- [Inspection Access mode 5-3](#)
- [INSPECTION DIRECTION SW. FAILURE 5-16](#)
- [Inspection Down Input 4-31](#)
- [Inspection input hierarchy 2-7](#)
- [INSPECTION MODE FAULT BYPASS 4-55](#)
- [Inspection Mode Fault Bypass 2-15, 2-29, 3-7, 3-36](#)
- [INSPECTION OPERATION 5-16](#)
- [INSPECTION OVERSPEED 5-24, 5-31](#)
- [Inspection Overspeed 4-117](#)
- [Inspection Speed \(Reduced\) 4-118](#)
- [Inspection Up Input 4-31](#)
- [INSUP 4-31](#)
- [Intermediate speed input 4-31](#)
- [Intermediate Speed, 151 4-117](#)
- [IP address screen 4-92](#)
- [IRCOF, Front Infra Red Cutout input option 4-31](#)
- [IRCOR, Rear Infra Red Cutout input option 4-31](#)
- [iReport 1-16](#)
- [iReport screen 4-94](#)
- [ISR, In service and ready flag 4-9](#)
- [ISRT, In Service and Running Output option 4-40](#)
- [ISRT, In service truly flag 4-9](#)
- [ISV, In service flag 4-9](#)
- [ISV, In Service Output option 4-40](#)
- [IUL, In Use Light output option 4-40](#)

## J

- [Jerk parameters 2-44, 2-46](#)
- [Job prints 2-2](#)
- [Jumper 5-2](#)
- [Jumper storage 2-50](#)
- [Jumpers for Construction operation 2-28](#)

## K

- [KCE DISABLED? 4-46](#)

## L

- [LANDING SYS A POSITION DEVIATION 5-31](#)
- [LANDING SYS B POSITION DEVIATION 5-31](#)
- [Landing System Interface Board 5-66](#)
- [Landing System Redundancy Input 4-32](#)
- [Landing system troubleshooting 5-25](#)
- [Landing System, 191 4-121](#)
- [LATCH FLASHING FIRE HAT? 4-17](#)
- [LD, Level down input flag 4-9](#)
- [Learn encoder 2-21](#)
- [Learn or Enter Motor or Encoder Data 2-21](#)
- [Learning Encoder Data 2-23](#)
- [LEAVE DOORS OPEN ON CTL option 4-21](#)
- [LEAVE DOORS OPEN ON EPI option 4-21](#)
- [LEAVE DOORS OPEN ON MGS 4-19](#)
- [LEAVE DOORS OPEN ON PTI/ESS option 4-19](#)
- [Level Dead Zone 4-118](#)
- [Level Distance 4-118](#)
- [Leveling distance parameter 3-11](#)
- [LEVELING DOWN 5-16](#)
- [LEVELING OVERSPEED 5-26](#)
- [Leveling Overspeed 4-117](#)
- [Leveling Speed 4-118](#)
- [Leveling speed parameter 3-11](#)
- [LEVELING UP 5-16](#)
- [LF. 2 2-32, A-2](#)
- [LF. 3 2-32, A-2](#)
- [LF. 5 2-32, A-2](#)
- [LF. 8 2-32, A-2](#)
- [LF. 9 2-32, A-2](#)
- [LF.11 2-32, A-2](#)
- [LF.12 2-32, A-2](#)
- [LF.13 2-32, A-2](#)
- [LF.14 2-32, A-3](#)
- [LF.15 2-33, A-3](#)
- [LF.16 2-33, A-3](#)
- [LF.18 2-33, A-3](#)
- [LF.19 2-33, A-3](#)
- [LF.21 2-33, A-3](#)
- [LF.22 2-33, A-3](#)
- [LF.23 2-33, A-3](#)
- [LF.25 2-33, A-3](#)
- [LF.27 2-33, A-3](#)
- [LF.28 2-33, A-3](#)
- [LF.30 2-33, A-3](#)
- [LF.41 2-34, A-4](#)
- [LF.42 2-34, A-4](#)
- [LF.44 2-34, A-4](#)
- [LF.45 2-34, A-4](#)

- LF.46 2-34, A-4
- LF.47 2-34, A-4
- LF.56 2-34, A-4
- LF.57 2-34, A-4
- LF.58 2-34, A-4
- LF.59 2-34, A-4
- LF.61 2-73
- LF.68 2-34, A-4
- LF.78 2-35, A-5
- LF.79 2-35, A-5
- LF.83 2-35, A-5
- LF.86 2-35, A-5
- LF.88 2-35, A-5
- LF.89 2-35, A-5
- LF.90 2-35, A-5
- LF.94 2-35, A-5
- LF.95 2-35, A-5
- LFP, Lower parking floor flag 4-9
- Light Load Input 4-31
- LIGHT LOAD WEIGHER CONDITION 5-16
- Light Load Weigher Output 4-40
- Limit switches 2-52
- LIMITED DOOR RE-OPEN OPTION option 4-21
- LLI, Light load input flag 4-9
- LLI, Light Load Input option 4-31
- LLW, Light Load Weigher Output option 4-40
- LLW, Light load weighing function input flag 4-9
- Load weigher
  - Calibration 3-30, 3-33
  - Control unit installation 3-28
  - Errors 3-34
  - Fuse 3-34
  - Programming 3-25
  - Rope stretch 3-33
  - Sensor installation 3-26
- Load Weigher Bypass 4-32
- Load weighing system
  - DLW (Dispatch load weigher threshold) 4-57
  - HLW (Heavy load weigher threshold) 4-57
  - LLW (Light load weigher threshold) 4-57
  - OLW (Overloaded car threshold) 4-57
  - setting load thresholds 4-58
- Loading Data from PM AC Encoder 2-23
- LOBBY FLOOR option 4-15
- LOCKOUT 2-25
- Loss of Control During Acceleration 3-20
- LOSS OF DOOR LOCK OUT OF DOOR ZONE 5-16
- LOT, Lobby door time flag 4-9
- LOTR, Lobby door time (rear) flag 4-9
- LOW VOLTAGE FIRE SENSORS 4-17
- Lower Final Limit Test 3-40
- LS-EDGE 3-4, 4-98
- LS-EDGE LEARN MODE ACTIVE 5-16
- LSR 4-32
- LU, Level up input flag 4-9
- LWB, Load Weigher Bypass input option 4-32
- LWCE 4-9

## M

- M2L INPUT FAILURE 5-16
- MABB INPUT FAILURE 5-17
- MABBR INPUT FAILURE 5-17
- MABGF INPUT FAILURE 5-17
- MABGR INPUT FAILURE 5-17
- MABT INPUT FAILURE 5-17
- MABTR INPUT FAILURE 5-17
- Machine room fire sensor 4-30
- MACHINE ROOM INSPECTION 5-17
- Magnetek
  - Additional tuning 3-19
  - Clear faults 2-24
  - Determining system inertia 3-19
  - Drive response adjustment 3-13
  - Encoder Alignment 2-47
  - Keypad overview 2-24
  - Motor tuning 2-27
  - Parameter table 2-36
  - Setup overview 2-26
  - Status indicators 2-25
  - Tuning motor flux saturation curve 3-19
  - Tuning motor no-load current 3-19
  - Verify motor speed 2-49
- Magnetek drive controls 2-16
- Magnetek status LEDs 2-25
- Main Fire Service 4-30
- Manual Acceleration 4-119
- Manual Curve 3-10
- Manual Deceleration 4-119
- Manual Induction Motor Parameter Entry 2-22
- Manual Override 4-32
- Manual Roll Jerk 4-119
- Manual Start Jerk 4-119
- Manual Stop Jerk 4-119
- MASS 524 CMR FIRE CODE? option 4-17
- MASSACHUSETTS EMS 4-44
- MASSACHUSETTS EMS SERVICE 5-9
- MASTER SOFTWARE KEY 4-44
- Master Software Key 4-53
- MBAB INPUT FAILURE 5-17
- MBABR INPUT FAILURE 5-18
- MC-CPI board 5-61
- MC-CPI CAN data viewing 4-91
- MC-LSI 5-66
- MC-LSI board 5-66
- MC-MPU Main Computer Board
  - setting parameters to default values 4-5
- MC-MPU Main Processing Unit 1-5
- MCSB INPUT FAILURE 5-18
- MDZLV INPUT FAILURE 5-18
- MECHANICAL SAFETY EDGE option 4-19
- Mechanically In Service Output 4-40
- Metric 4-64
- Metric or English units 4-64
- MG SHUTDOWN OPERATION 4-43
- MGB INPUT FAILURE 5-18
- MGBR INPUT FAILURE 5-18
- MGR OUTPUT TIMER 4-23
- MGS 4-32

MGS INPUT FAILURE 5-18  
 MGSR INPUT FAILURE 5-19  
 MHDB INPUT FAILURE 5-19  
 MHDBR INPUT FAILURE 5-19  
 MISV, Mechanically In Service Output option 4-40  
 MLT, Motor Limit Timer Elapsed Output option 4-40  
 MLT, Motor limit timer flag 4-9  
 MNO 4-32  
 MOMENT D.O.B. FOR 4-20  
 MOMENT. D.C.B TO CLOSE DOORS 4-22  
 MOMENT. D.O.B. DOOR OPENING 4-20  
 Monitored type screen 4-92  
 Monitoring input for BAB 4-27  
 Motion (speed/distance) viewing 4-64  
 Motion Processor Interface board 5-71  
 Motion/Position Diagnostics 4-64  
 Motor insulation test 2-11  
 Motor leads 2-4, 2-11  
 Motor Limit Timer 5-19  
 MOTOR LIMIT TIMER ANTI STALL ELAPSED 5-19  
 Motor Limit Timer Elapsed Output 4-40  
 Motor nameplate data 2-21  
 MP (Motion Processor) 5-71  
 mPAC 1-3  
 mPac 1-6  
 MPI A or B 2L BUS IS LOW 5-20  
 MPI A or B 2MV BUS MONITOR FAULT 5-20  
 MPI A or B ACTUAL AND REQUESTED DIRECTION MISMATCH 5-20  
 MPI A or B CONTRACT OVERSPEED 5-21  
 MPI A or B DET SW OVERSPEED 5-21  
 MPI A or B DET SW POSITION FAULT 5-21  
 MPI A or B DNT SW HIGH OVERSPEED 5-21  
 MPI A or B DNT SW POSITION FAULT 5-22  
 MPI A or B DNTS LOW OVERSPEED 5-22  
 MPI A or B DOWN NORMAL LIMIT OPEN 5-22  
 MPI A or B DRIVE FAULT 5-22  
 MPI A or B DRIVE NOT READY 5-22  
 MPI A or B DRIVE ON FAULT 5-22  
 MPI A or B EBPS MONITOR FAULT 5-23  
 MPI A or B EEPROM FAULT 5-23  
 MPI A or B EMERGENCY BRAKE CYCLE TEST FAULT 5-23  
 MPI A or B ETS SHUTDOWN FAULT 5-23  
 MPI A or B EXCESSIVE FAULTS SHUTDOWN 5-23  
 MPI A or B GOVERNOR OVERSPEED 5-23  
 MPI A or B INCORRECT LANDING SYSTEM CHANNEL DETECTED 5-24  
 MPI A or B INSPECTION OVERSPEED 5-24  
 MPI A or B LANDING SYSTEM COMM LOSS 4-91, 5-25  
 MPI A or B LANDING SYSTEM FAULT (EMERGENCY BRAKE DROPPED) 5-25  
 MPI A or B LEVELING OVERSPEED 5-26  
 MPI A or B PMDD CONTACTOR DROP MONITOR 5-26  
 MPI A or B PMDD CONTACTOR PICK MONITOR 5-26  
 MPI A or B RELATIVE POSITION HIGH 5-26  
 MPI A or B RELATIVE POSITION LOW 5-26  
 MPI A or B RGOK DROPPED 5-27  
 MPI A or B RGOK FAILED TO ACTIVATE 5-27  
 MPI A or B RGOK FAILED TO DEACTIVATE 5-27  
 MPI A or B SPC IS OFFLINE 5-27  
 MPI A or B UET SW OVERSPEED 5-27  
 MPI A or B UET SW POSITION FAULT 5-28  
 MPI A or B UNINTENDED MOTION FAULT 5-28  
 MPI A or B UNT SW HIGH OVERSPEED 5-28  
 MPI A or B UNT SW LOW OVERSPEED 5-28  
 MPI A or B UNT SW POSITION FAULT 5-29  
 MPI A or B UP NORMAL LIMIT OPEN 5-29  
 MPI A SPB IS OFFLINE 5-20  
 MPI B SPA IS OFFLINE 5-29  
 MPI C CONTRACT OVERSPEED 5-29  
 MPI C DRIVE FAULT 5-29  
 MPI C DRIVE NOT READY 5-29  
 MPI C DRIVE OFFLINE (STOP MODE) 5-30  
 MPI C DRIVE ON FAILED TO ACTIVATE 5-30  
 MPI C DRIVE ON FAILED TO DEACTIVATE 5-30  
 MPI C DRIVE ON LOST 5-30  
 MPI C EEPROM CRC ERROR 5-30  
 MPI C EEPROM DEVICE ERROR 5-30  
 MPI C EXCESSIVE FAULTS SHUTDOWN 5-30  
 MPI C FOLLOWING ERROR 5-31  
 MPI C INSPECTION OVERSPEED 5-31  
 MPI C LANDING SYS A POSITION DEVIATION 5-31  
 MPI C LANDING SYS B POSITION DEVIATION 5-31  
 MPI C LEVELING TIMER EXCEEDED 5-31  
 MPI C UNEXPECTED DIRECTION DROP 5-32  
 MPI Diagnostic Menu 4-64  
     English or Metric 4-64  
 MPI SPA IS OFF LINE message 5-19  
 MPI SPB IS OFF LINE message 5-19  
 MPI SPC IS OFF LINE message 5-19  
 MPI-A BRAKE MODULE 1 IS OFFLINE 5-20  
 MPI-A BRAKE MODULE 2 IS OFFLINE 5-20  
 MPI-B BRAKE MODULE 1 IS OFFLINE 5-29  
 MPI-B BRAKE MODULE 3 IS OFFLINE 5-29  
 MSAFL1 INPUT FAILURE message 5-32  
 MSAFS1 INPUT FAILURE message 5-32  
 MSSD FAILED ACTIVE message 5-32  
 MTAB INPUT FAILURE 5-32  
 MTABR INPUT FAILURE 5-32  
 MTBR INPUT FAILED TO ACTIVATE 5-32  
 MTBR INPUT FAILED TO DEACTIVATE 5-32  
 MTPM INPUT FAILED TO ACTIVATE 5-33  
 MTPM INPUT FAILED TO DEACTIVATE 5-33  
 MUSE INPUT IS LOW 5-33  
 mView 1-17

## N

N, S, +, - Push Buttons 4-4  
NBZX 4-40  
NCD, Car Not Done with Emergency Power Return 4-40  
NDGBPS, Nudging bypass flag 4-9  
NDGBPSR, Nudging bypass flag (rear) 4-9  
NDGF, Nudging function flag 4-9  
NDGRX 4-40  
NDGX 4-40  
NDS, Hall door timer non-shorten flag 4-9  
NDSR, Hall door timer non-shorten (rear) flag 4-9  
NEMA 4, 12 2-3  
NEW YORK CITY FIRE PHASE 2 AND ANSI 89 option 4-17  
Nomenclature 2-5  
Non-Stop Input (Attendant Service) 4-32  
Normal Brake Drop Rate, 198 4-122  
Normal Brake Hold Voltage, 195 4-122  
Normal Brake Lift Rate, 197 4-122  
Normal Brake Pick Voltage, 194 4-122  
Normal Brake Relevel Voltage, 195 4-122  
NORMAL OPERATION 5-33  
NORMAL PIT FLOOR OPERATION 5-33  
NSI, Non-Stop Input (Attendant Service) option 4-32  
NTS and ETS Switch Locations 3-15  
NTS Delta High Speed Test 3-43  
NTS Delta Low Speed Test 3-43  
NTS Switch Delta Values 3-17  
NUDG, Nudging output flag 4-9  
Nudging 5-42  
Nudging Buzzer Auxiliary output. 4-40  
NUDGING DURING FIRE PH. 1 option 4-18  
NUDGING DURING FIRE PHASE 2 option 4-19  
NUDGING OUTPUT/BUZZER ONLY option 4-19  
NUDGR, Nudging output (rear) flag 4-9  
Number of cars configured 4-93  
NYCHA 5-2  
NYDS, New York door shortening flag 4-10

## O

O.LF.98 2-35, A-5  
OFR, One Floor Run Output option 4-40  
OFRP 4-41  
OFRP BETWEEN FLRS option 4-47  
OLW, Overloaded Car Threshold Output option 4-41  
One Floor Run Output 4-40  
One Floor Run Programmable 4-41  
Operating modes 1-9  
OPERATION (DISPATCHING OPERATION) option 4-13  
OPN/CLS INTRLOCK TIMER 4-24  
Options, setting to default values 4-5  
OVERLOAD CONDITION 5-33  
Overload Input 4-32  
Overloaded Car Threshold Output 4-41  
OVL, Overload Input option 4-32  
OVL2 4-32  
OVL2, Overload 2 Input 4-32

## P

P.LF.32 2-33, A-3  
P9LSS 2-32, A-2  
Parameter ID (F7) 4-102  
Parameters, setting to default values 4-5  
Passcode Request 4-5, 5-33  
Passing Floor Gong Auxiliary output. 4-41  
Passing Floor Gong Enable Input 4-32  
PASSWORD TIMER 4-24  
PCLSD 2-32, A-2  
PFG ENABLE BUTTON? option 4-25  
PFG, Passing floor gong output flag 4-10  
PFGE, Passing Floor Gong Enable Input option 4-32  
PFGX 4-41  
PH1, Fire Service Phase 1 Return Complete Output 4-41  
PH1, Phase 1 return complete flag 4-10  
PHE, Photo eye input flag 4-10  
PHER, Photo eye input (rear) flag 4-10  
PHERX 4-32  
PHEX 4-32  
PHOTO EYE ANTI-NUISANCE 4-43  
PI Turned Off if No Demand 4-24, 4-44  
PI1 - PI8 4-41  
PIC, PI correction flag 4-10  
Pit Flood 4-32, 4-47  
PIT FLOOD OPERATION 5-33  
PITFLD 4-32  
PMP INPUT FAILED TO ACTIVATE 5-33  
PMP INPUT FAILED TO DEACTIVATE 5-33  
PMT 5-2  
Position display 4-55  
Position indicators 2-72  
POSTN 0.0 IN 4-55  
Power for boards inside controller 5-39  
Power line fluctuation 2-3  
Power Transfer Input 4-32  
POWER TRANSFER INPUT ACTIVE 5-33, 5-34  
Power up 2-10  
PowerBack R6 Regenerative Drive  
    Parameters Quick Reference A-28  
PRE-OPENING option 4-19  
Preparing for Final Adjustments  
    counterweight balancing 3-6  
PREVENT DCP TIL DOORS CLOSE? option 4-22  
PRIFLG, Priority Service Output option 4-41  
Primary motor drop delay contactor 5-26  
Prior to Applying Power 2-54  
Priority Service Output 4-41  
Profile Advance 3-13, 3-14, 4-116  
Profile Compensation, 193 4-122  
Profile Scale 4-116  
Program Mode 4-12  
Programmable auxiliary rear door zone input 4-29  
Programmable, auxiliary front door zone input 4-29  
Programmable, auxiliary photo eye input 4-32  
Programmable, auxiliary step down input 4-33  
Programmable, auxiliary step up input. 4-33  
Proximity Distance 4-118  
PTI, Power Transfer Input option 4-32  
PTIC 4-32

## R

R2AB Redundancy monitoring input 4-32  
R2L 4-32  
R2L INPUT FAILURE 5-34  
R4, Absolute floor encoding #4 flag 4-10  
R4, R3, R2, Floor Encoding Input option 4-32  
R6 Regenerative AC drive parameters A-28  
Rated Motor Speed 3-24  
RBAB Redundancy monitoring input 4-32  
RCOMP 4-41  
RDLSR 4-33  
RDR SPA IS OFFLINE 5-34  
RDR SPB IS OFFLINE 5-34  
Rear Access Gate Bypass Monitor 5-17  
REAR CAR DOOR BYPASS SW. FAILURE 5-34  
REAR DOL & DLK ARE BOTH ACTIVE 5-34  
Rear Door Buzzer 4-37  
REAR DOOR CLOSE LIMIT 4-49  
Rear Door Close Limit Contact 5-7  
REAR DOOR FAILED TO CLOSE 5-34  
REAR DOOR IS LOCKED BUT NOT FULLY CLOSED 5-34  
Rear Door Lock Relay Redundancy input 4-33  
REAR DOOR LOCK SWITCH FAILURE 5-35  
REAR DOOR MECH. COUPLED 4-22  
REAR DOOR OPEN LIMIT FAILURE 5-35  
Rear Down Hall Call indicators 4-36  
REAR DZ RELAY DISCREPANCY 5-35  
REAR GATE SWITCH FAILURE 5-35  
Rear Gate Switch Monitor 5-19  
REAR HOISTWAY DOOR BYPASS SW. FAILURE 5-35  
Rear Infrared Cutout 4-31  
Rear Up Hall Call indicators 4-36  
REAR, Rear door flag 4-10  
Receive/Transmit screen 4-94  
REDUCE HCT WITH PHOTO EYE option 4-21  
Reduced Inspection Speed 4-121  
Reduced stroke buffers 4-111, 4-115  
Redundancy Gate Switch 4-33  
Redundancy monitoring input 4-33  
Refresh Device 4-94  
Refresh XPort 4-95  
Relevel Operation 3-20  
Re-Leveling Distance 4-118  
Re-Leveling Speed 4-118  
REO, Re-Open Input option 4-33  
Re-Open Input 4-33  
Rescue Complete 4-41  
Reset Drive 4-41  
Reset Excessive Faults 3-8  
Reset XPort screen 4-94  
Resetting the rope gripper 2-14  
Resolving Faults 2-29  
RESTORING SAFETY 5-35  
Retiring Cam 5-8  
RETIRING CAM option 4-19  
REVD 4-33  
Reverse Direction input 4-33  
RFI 2-3  
RGOK FAILED TO ACTIVATE 5-27  
RGOK FAILED TO DEACTIVATE 5-27

RGS 4-33  
RGSR 4-33  
RINAX 4-33  
Rope gripper reset 2-14  
RSTDRV 4-41  
Run Tests 3-20  
Run the motor 2-20, 2-25  
RUN, Run flag 4-10  
RUN/A/B 4-33

## S

S = Slave 4-6  
S in upper left corner of LCD 5-37  
SAB, Sabbath input flag 4-10  
SAB, Sabbath Operation Input option 4-33  
SABBATH OPERATION 4-46  
Sabbath Operation 4-46  
SABBATH OPERATION ACTIVE 5-35  
Sabbath Operation Input 4-33  
SAF 4-10  
SAFC 4-33  
SAFC INPUT FAILURE 5-35  
SAFETY CIRCUIT IS OPEN 5-35  
SAFETY DROPPED BY SPB 5-35  
SAFH 4-33  
SAFO 4-41  
Saving Changes 4-11  
SC-3HN 1-8  
SC-3HN board 5-67  
SCE, Stepping correction enable flag 4-10  
Schematic symbols, description of 2-5  
SCROLLING SPEED 4-47  
SCROLLING SPEED option 4-48  
SD, Supervisory down flag 4-10  
SDA, Down direction arrow flag 4-10  
SDT, Short door time flag 4-10  
SDTR, Short door time flag (rear) 4-10  
SE, Safety edge input flag 4-10  
SEC, Security Code Incorrect output option 4-41  
SECONDARY PARKING FLOOR option 4-15  
Security Code Incorrect 4-41  
Seismic equipment install 2-53  
Selective Collective 4-13  
SEQUENTIAL DOOR OPER. (F/R) option 4-18  
SER, Safety edge input (rear) flag 4-10  
Serial car panel CAN data 4-91  
Serial car panel option 1-3  
Serial hall call 1-3  
Serial Hall Call Node Board 5-67  
SerSP 2-32, A-2  
Set ETS Switch Delta Values 3-17  
Set NTS Switch Delta Values 3-17  
set parameters to default values 4-5  
Sheave Brake Idle Delay, 190 4-121  
Shorts 2-9  
Signal operating mode 2-32, A-2  
SIMP, Simplex Input option 4-33  
Simplex Input 4-33  
SIMPLEX OR DUPLEX option 4-13  
Simplex Output 4-41

SIMPO, Simplex Output option 4-41  
 Sin/Cos 2-23  
 Single Automatic Push button 4-13  
 Single Button Collective 4-13  
 SINGLE SPEED AC OPTION 4-46  
 Slew Filter 4-116  
 SLV, Stable slave flag 4-10  
 Software version  
     CHP 4-125  
     CTLA 4-125  
     CTLB 4-125  
     CTLC 4-125  
     MPIA 4-125  
     MPIB 4-125  
     MPIC 4-125  
     MPUA 4-125  
     UIO 4-125  
 SPA (Safety Processor A) 5-71  
 SPA IS OFFLINE 5-29, 5-36  
 SPARE OUTPUTS MENU OPTIONS 4-35  
 SPB (Safety Processor B) 5-71  
 SPB IS OFFLINE 5-20, 5-36  
 SPC IS OFFLINE 5-27, 5-36  
 Specifications 1-2  
 SPEED 0 FPM 4-55  
 Speed and Acceleration Control 2-30  
 Speed Changes Felt Excessively in Car 3-20  
 Speed Drop Delay, 192 4-121  
 Speed Hysteresis Delay 4-116  
 Speed Hysteresis Delay, 139 4-116  
 Speed Pick Delay Time 4-115  
 SST, Soft stop timer flag flag 4-9  
 Standard Acceleration 4-119  
 Standard Curve 3-10  
 Standard Deceleration 4-119  
 Standard Roll Jerk 4-118  
 Standard Slew Slope 4-116  
 Standard Start Jerk 4-118  
 Standard Stop Jerk 4-118  
 Start Input 4-33  
 Start jerk 3-11  
 STARTIN, Start Input option 4-33  
 STDX 4-33  
 STOP 4-33  
 Stop SW 5-15  
 STUCK PHOTO EYE PROTECTION option 4-18  
 STUX 4-33  
 SU, Supervisory up flag 4-10  
 SUA, Up direction arrow flag 4-10  
 Subnet mask screen 4-92  
 SWG 4-33  
 System CAN Bus 4-91

## T

TAPS 2-73  
     KEB LF61 1-3  
     LF61 KEB Setting 2-34  
 TAPS Backup 1-14  
 TAPS Fault input 4-30  
 TC-MPI 1-5  
 TEMPB, Temporary bit flag 4-10  
 Temporary controller box 2-28  
 Temporary jumpers 2-28  
 Temporary run box wiring 2-50  
 Terminal Learn 3-17  
 TEST, Test switch input flag 4-10  
 Testing motor insulation 2-11  
 TESTSWO 4-41  
 TFA, Timing function active flag 4-10  
 TFAR, Timing function active (rear) flag 4-10  
 TFD, Top floor demand flag 4-10  
 TFTP Status screen 4-95  
 TIME OUT OF SERVICE 5-36  
 Timed Out of Service Output 4-41  
 Timer Menu options 4-23, 4-24  
 Top Access Bypass Monitor 5-17  
 Top Access Distance 4-108  
 TOP ACCESS SW. FAILURE 5-36  
 TOP ACCESS? 4-49  
 TOP LANDING FOR OTHER CAR? 4-14  
 TOP LANDING SERVED option 4-14  
 Top Rear Access Bypass Monitor 5-17  
 Torqmax Display 2-18, 2-24  
 Torqmax F5 drive 2-17  
 TOS, Time Out of Service Output option 4-41  
 TOS, Timed out of service flag 4-10  
 Traction Auxiliary Power Supply 2-73  
 Traction Auxiliary Power Supply (TAPS) 1-3  
 Traveler Cable 1-8  
 Triac 5-3  
 Troubleshooting  
     duplexing 5-37  
 True Fire Service Output 4-39

## U

- UC, Up call flag 4-10
- UCA, Up call above flag 4-10
- UCR, Up call flag (rear) 4-10
- UDF 4-33
- UDP, Up direction preference flag 4-10
- UET SW OVERSPEED 5-27
- UET SW POSITION FAULT 5-28
- UETS 4-111
- UETS Delta Distance 4-111
- UETS Delta High Speed 4-111
- UETS Distance 4-111
- UETS Speed 4-111, 4-114
- UETS Speed, 75 4-111
- UFL 4-33
- UFP, Upper parking floor flag 4-10
- UFQ, Up first qualifier flag 4-10
- Unintended Motion 3-47
- UNINTENDED MOTION FAULT 5-28
- Unintended Motion, 188 4-121
- Universal I/O 1-3
- UNT SW HIGH OVERSPEED 5-28
- UNT SW LOW OVERSPEED 5-28
- UNT1 5-74
- UNTS POSITION FAULT 5-29
- UNTS1 Delta Distance 4-113
- UNTS1 Delta High Speed 4-113
- UNTS1 Delta High Speed, 83 4-113
- UNTS1 Distance 4-113
- UNTS1 Speed, 79 4-113
- UNTS2, 3, 4, 5 4-113
- UP AND DOWN TERMINAL SPEED REDUCING LIMITS
- OPEN 5-36
- Up Emergency Terminal overspeed 5-27
- Up Emergency Terminal Switch 4-111
- Up Final Limit Input 4-33
- Up Input (Attendant Service) 4-34
- Up Normal Terminal Switch High overspeed 5-28
- Up Normal Terminal Switch Low overspeed 5-28
- Up Output (Attendant Service) 4-41
- Up Sense 4-41
- UPD, Up previous direction flag 4-10
- Update firmware 5-40
- UPDO, Up direction output flag 4-10
- Upgrading Motion 4000 Firmware 5-40
- UPL, Up Input (Attendant Service) 4-34
- UPO, Up Output (Attendant Service) option 4-41
- Upper Final Limit Test 3-40
- UPS 4-41
- UPS, Up direction sense input flag 4-10
- US. 3 2-35, A-5
- US. 4 2-35, A-5
- US.10 2-35, A-5
- US.34 2-35, A-5
- USD, Up slow down input flag 4-10

## V

- V 4-96
- VCI 4-9
- Velocity Encoder
  - Connections 2-13
- Velocity Encoder Installation 2-51
- Verify encoder type 2-23
- Verify Motor Speed, KEB/TorqueMAX 2-49
- Verify Motor Speed, Magnetek 2-49
- Verify One Floor Run Operation 3-14
- Verifying Contract Speed Operation 3-15
- Version number of the monitoring software 4-92
- Video rescue system 4-32
- View assigned spare inputs 4-26
- View assigned spare outputs 4-35
- View car speed and distances 4-64
- View Event Log 4-63
- View events 4-63

## W

- Wandering Patient Security 4-34, 4-43
- WHITE PLAINS, NY FIRE CODE option 4-17
- Wild Operation Indication Output 4-41
- WILL THIS CAR RUN ON PH2? 4-16
- Wiring prints, description of 2-5
- WLD, Emergency Dispatch Input option 4-34
- WLDI, Wildop Indication Output option 4-41
- WPIA - H 4-34
- WPIx LANDING? 4-43

## X

- XDSA, Auxiliary Supervisory Down Arrow output option 4-41
- xNTSn Delta Distance 4-112
- xNTSn Delta High Speed 4-112
- xNTSn Delta Low Speed 4-112
- xNTSn Distance 4-112
- xNTSn Speed 4-112
- XPI1-XPI7, Auxiliary Position Indicators 1 thru 7 output 4-41
- XPort Comm Resets screen 4-93
- XSUA, Auxiliary Supervisory Up Arrow output option 4-41

## Z

- ZADJ, Zero Adjust output option 4-41
- Zero Adjust 4-41